

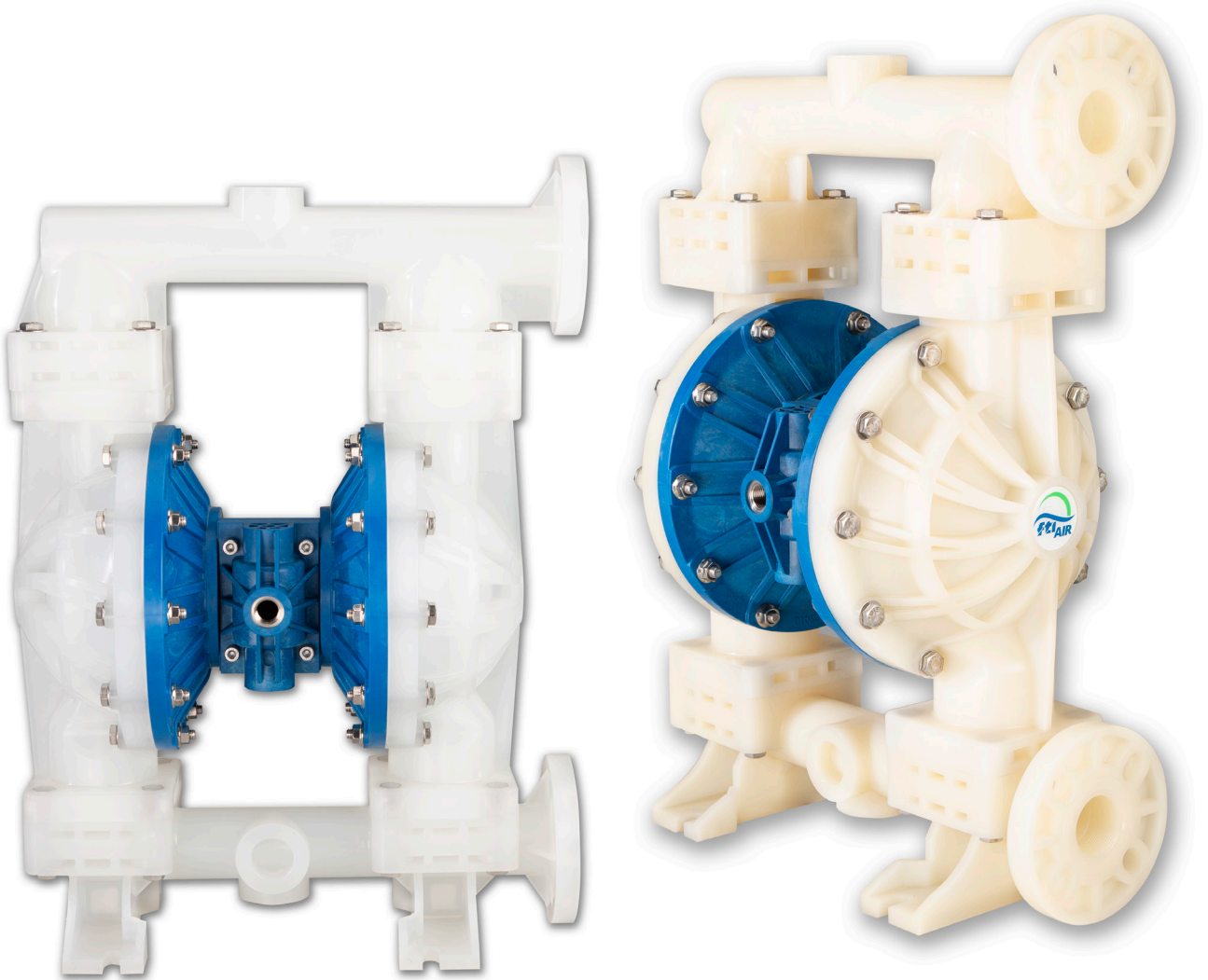

FTI AIR AODD MODELS FT15ZP & FT15ZV

Assembly, Installation, & Operation Manual

P/N 109874 R3



Record your Model and Serial Number here.

MODEL NUMBER _____

SERIAL NUMBER _____

Order Online: www.PumpCatalog.com



EU Declaration of Conformity



FTI Air hereby declares that the following machine(s) fully comply with the applicable health and safety requirements as specified by the EC Directives listed. The complete product complies with the provisions of the EC Directive on machinery safety.

This declaration is valid provided that the devices are fully assembled and no modifications are made to these devices.

Type of Device:

Air Operated Double Diaphragm Pumps

Models:

FT025P, FT025V, FT025C, FT05P, FT05V, FT05A, FT05S,
FT10P, FT10V, FT10A, FT10S, FT15P, FT15V, FT15A, FT15S, FT15ZP, FT15ZV, FT15ZA, FT15ZS,
FT20P, FT20V, FT20A, FT20S, FT30A & FT30S

EC Directives:

Machinery Safety (2006/42/EC)

Applied Harmonized Standards:

EN ISO 12100

Manufacturer:

FTI Air A Division of Finish Thompson, Inc.
921 Greengarden Road
Erie, Pennsylvania 16501-1591 U.S.A

Signed,

President

23 May 2019

Person(s) Authorized to Compile Technical File: FTI Air GmbH
Otto-Hahn-Strasse 16
Maintal, D-63477 DEU
Telephone: 49 (0)6181-90878-0

Table of Contents

Important Information - READ ME FIRST

Export Regulation Notice	4
Chemical Reaction Disclaimer	4
Safety Precautions	4-5

Pump Specifications

Materials Profiles.....	5
Model Number Explanation & Example Part Numbers.....	6
Specifications.....	6
Dimensional Drawing.....	7
Performance Curve.....	7

Installation/Operation

Installation Drawing.....	8
Precautions.....	8
Troubleshooting.....	9

Maintenance

Recommended Tools	9
Wet End Servicing	9
Disassembly	10-11
Reassembly	12-15
Air End Servicing	16
Shaft Bushing & O-ring Replacement.....	16-17
Air Valve O-ring Replacement.....	18
Valve Gasket Replacement.....	19-20
Air Valve Slide, Plate, & Gasket Orientation.....	19
Replacement Air Valve Kit Installation.....	20
Exploded View	21
Spare Parts List.....	21-24

Warranty	25
-----------------------	----

Important Information- Read Me first

IMPORTANT NOTICE

U.S. Export Administration Regulations, pursuant to ECCN 2B350, prohibit the export or re-export to certain enumerated countries of air operated double diaphragm pumps in which all wetted materials are constructed from fluoropolymers without first applying for and obtaining a license from the U.S. Bureau of Industry and Security (BIS). This affects all FTI AIR pumps constructed from PVDF with PTFE balls and diaphragms. Please contact the BIS (www.bis.doc.gov) or FTI AIR with questions regarding the Regulations or a list of the countries to which they apply.

Chemical Reaction Disclaimer

The user must exercise primary responsibility in selecting the product's materials of construction which are compatible with the fluid(s) that come(s) in contact with the product. The user may consult FTI AIR (manufacturer) and a manufacturer's representative/distributor agent to seek a recommendation of the product's material of construction that offers the optimum available chemical compatibility.

However neither manufacturer nor agent shall be liable for product damage or failure, injuries, or any other damage or loss arising out of a reaction, interaction or any chemical effect that occurs between the materials of the product's construction and fluids that come into contact with the product's components.

Unpacking & Inspection

Unpack the pump and examine for any signs of shipping damage. If damage is detected, save the packaging and notify the carrier immediately.

To install the pump, follow the installation instructions provided

Safety Precautions

⚠ WARNING: Never use a natural polypropylene or natural PVDF pump with flammable or combustible fluids/materials.

⚠ WARNING: FTI AIR maximum temperature limits are based upon the material's mechanical stress only. Maximum temperature is application dependent. Consult a chemical resistance guide or the chemical manufacturer for chemical compatibility and temperature limits.

⚠ WARNING: Chemical Hazard. This pump is used for transferring many types of potentially dangerous chemicals. Always wear protective clothing, eye protection and follow standard safety procedures when handling corrosive or personally harmful materials. Proper procedures should be followed for draining and decontaminating the pump before disassembly and inspection of the pump. There may be small quantities of chemicals present during inspection.

⚠ WARNING: Hot surfaces. FTI AIR pumps are capable of handling liquids with temperatures as high as 220°F (104°C). This may cause the outer areas of the pump to become hot as well and could cause burns.

⚠ WARNING: If a diaphragm rupture occurs, material being pumped may be forced out of the air exhaust. Proper care should be taken, always wear protective clothing, eye protection & follow standard safety procedures.

⚠ WARNING: When pumping hazardous liquids, or operating the pump in an enclosed room, it is important to pipe the exhaust air to a safe area.

⚠ WARNING: For polypropylene or PVDF pumps do not exceed 100 psig (6.9 bar) air supply & 120 psig (8.3 bar) for aluminum and stainless steel.

⚠ CAUTION: Before attaching air supply to pump to make sure all airline debris is clear. It is recommended to use a minimum 5μ (micron) air filter before the air valve.

⚠ CAUTION: Use only genuine FTI AIR replacement parts to assure compatibility & longest service life.

⚠ CAUTION: Before maintenance or repair, close the compressed air line supply valve, bleed the pressure and disconnect air line from the pump. Discharge line may also be pressurized. Any pressure must be relieved prior to servicing. Remove suction / discharge lines & drain the pump.

⚠ CAUTION: If pump is used with materials that tend to solidify or settle, the pump should be flushed after each use to prevent damage.

⚠ WARNING: Pump exhaust may be loud and contain particles. Wear appropriate ear and eye protection. In the event of a diaphragm rupture material can be forced out of the air exhaust muffler. If product is hazardous or toxic, pipe exhaust to appropriate safe area.

⚠ CAUTION: Do not over-tighten the air inlet fitting or muffler. Too much torque could damage the air valve or muffler plate.

⚠ CAUTION: Check the temperature limits for all wetted components when choosing pump materials. See table below.

⚠ EXPLOSION HAZARD! FTI AIR pumps with standard materials of construction should not be used with halogenated hydrocarbons. Halogenated hydrocarbon solvents can cause explosion when used with aluminum components in a closed (pressurized) system. FTI AIR pumps with standard materials of construction contain aluminum components and will be affected by halogenated hydrocarbon solvents.

1-1-1 Trichloroethane and Methylene Chloride are the most common halogenated hydrocarbons. However, other halogenated hydrocarbon solvents are suspect if used either as part of paint or adhesive formulation, or for clean-up flushing.

For applications that may involve halogenated hydrocarbons, contact FTI AIR to discuss the availability of alternative pump materials of construction.

Material Profiles

Material	Chemical Composition	Description	Operating Temperature		Relative Cost
			Minimum	Maximum	
Polypropylene	Pure Polypropylene	Thermoplastic that is resistant to alkali and strong acids.	32°F (0°C)	158°F (70°C)	\$
PVDF	Pure Polyvinylidene Fluoride	Strong fluoropolymer with excellent chemical resistance.	10°F (-12°C)	220°F (104°C)	\$\$\$
Stainless Steel	316 Stainless Steel	Excellent chemical resistance, high tensile and impact strength, abrasion resistant.	Limited by other materials used		\$\$
Aluminum	ADC 12, LM24, LM25	Moderate chemical resistance with good impact strength and abrasion resistance.	Limited by other materials used		\$
Buna	Acrylonitrile-butadiene Rubber	General purpose elastomer. Resistant to oil, water, solvent, and hydraulic fluid.	10°F (-12°C)	190°F (88°C)	\$
EPDM	Ethylene Propylene Diene Rubber	Good resistance to mild acids, detergents, alkalis, ketones, and alcohols.	-40°F (-40°C)	250°F (121°C)	\$
FKM	Fluorocarbon Rubber	Good chemical resistance and high temperature properties. Resistant to most acids, aliphatic, aromatic, and halogenated hydrocarbons, oils, grease, and fuels.	-40°F (-40°C)	350°F (177°C)	\$\$
Neoprene	Chloroprene Rubber	General purpose elastomer with good resistance to moderate chemicals, oils, grease, solvents, and some refrigerants.	0°F (-18°C)	212°F (100°C)	\$
Santoprene™	Fully cured EPDM rubber particles encapsulated in a polypropylene (PP) matrix	Thermoplastic elastomer with good abrasion resistance with chemical resistance to a wide range of solvents and chemicals. Injection molded with no fabric layer.	-40°F (-40°C)	225°F (107°C)	\$
Hytrel®	Thermoplastic polyester elastomer	Combines resistance and flexibility of elastomers with the strength of plastics. Resistant to acids, bases, amines, and glycols. Injection molded with no fabric layer.	-20°F (-29°C)	220°F (104°C)	\$
Polyurethane	Polyester Urethane	Thermoplastic that exhibits excellent abrasion resistance. Injection molded with no fabric layer.	32°F (0°C)	150°F (66°C)	\$
PTFE	Polytetrafluoroethylene	Chemically inert. Resistant to a wide range of chemicals.	40°F (4°C)	225°F (107°C)	\$\$
FEP	Fluorinated Ethylene Propylene	Similar to PTFE in composition and chemical resistance. Used to encapsulate FKM o-rings for superior chemical resistance.	40°F (4°C)	225°F (107°C)	\$\$

Santoprene™ is a registered tradename of Exxon Mobil Corp.
Hytrel® is a registered tradename of Dupont™

Model Number Explanation & Example Part Numbers

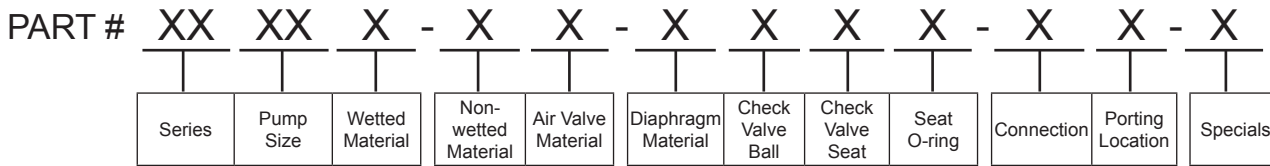

Series*

FT - Pump End
FW - Wet End

Pump Size*

15Z - 1.5"

Wetted Materials*

P - Polypropylene, FDA
V - PVDF

Non-wetted Materials

P - GFRPP

Air Valve Materials

A - Aluminum
Q - GFRPP w/ prox sensor
P - GFRPP
B - Aluminum w/ prox sensor

Diaphragm Materials*

N - Neoprene
B - Buna-N, FDA
E - EPDM
F - FKM
R - Santoprene
H - Hytrel
U - Polyurethane
1 - PTFE/Neoprene
2 - PTFE/Santoprene
3 - PTFE/BUNA, FDA
4 - PTFE/Santoprene, FDA
5 - Santoprene, FDA
6 - Hytrel, FDA

Check Valve Ball Materials*

N - Neoprene
B - Buna-N
E - EPDM
S - 316SS, FDA
W - Weighted PTFE, FDA
F - FKM
R - Santoprene
T - PTFE, FDA
5 - Santoprene, FDA

Check Valve Seat Materials*

P - Polypropylene, FDA
A - Aluminum
T - PTFE
B - Buna-N
F - FKM
H - Hytrel
U - Polyurethane
V - PVDF
S - 316SS
N - Neoprene
E - EPDM
R - Santoprene
5 - Santoprene, FDA
6 - Hytrel, FDA

Check Valve Seat O-Ring Materials*

N - Neoprene
E - EPDM
F - FKM
R - Santoprene
B - Buna-N
U - Polyurethane
C - FEP/FKM, FDA
0 - None

Connection

N - ANSI/DIN/ISO Flange w/ FNPT
B - ANSI/DIN/ISO Flange w/ FBSPT

Porting location

1 - End (standard)
3 - Center vertical
2 - Center horizontal
4 - Center vertical suction & end discharge

Specials

M1 - Metal muffler
M2 - Oversized metal muffler
B1 - Blind flange kit
P1 - Halogenated hydrocarbon compatible

*Required for wet end

Example Pump P/N's: FT15ZP-PP-RRPR-N1, FT15ZP-PA-BBPB-N1, FT15ZV-PP-1TVG-N1 & FT15ZV-PA-FFVF-N1

Example Wet End P/N's: FW15ZP-RRPR, FW15ZP-BBPB, FW15ZV-1TVG & FW15ZV-FFVF

Specifications

Pump Type: Non-Metallic Air Operated Double Diaphragm	
Weight:	PP - 41 lbs (18.6 kgs) PVDF - 60 lbs (27.2 kgs)
Air Inlet/Exhaust Size:	1/2" FNPT/3/4" FNPT
Max Air Inlet Pressure:	100 psig (6.9 bar)
Max Material Inlet Pressure:	10 psig (0.7 bar)
Air Consumption @ 100 psi:	100 scfm (170 Nm ³ /hr)
Noise Level:	77 dB(A)
Max Suction Lift:	Wet - 28 ft H ₂ O (8.5 m H ₂ O) Dry - Rubber/PTFE: 18 ft H ₂ O (5.5 m H ₂ O) TPE: 28 ft H ₂ O (8.5 m H ₂ O)
Max Flow Rate:	125 gpm (473 lpm)
Suction/Discharge Size:	1-1/2" ANSI/DIN/ISO flange
Max Particle Size:	0.38" (9.7 mm)
Max Outlet Pressure:	100 psig (6.9 bar)
Displacement Per Stroke:	0.24 gal (0.91 liter)

FT15ZP & FT15ZV Performance

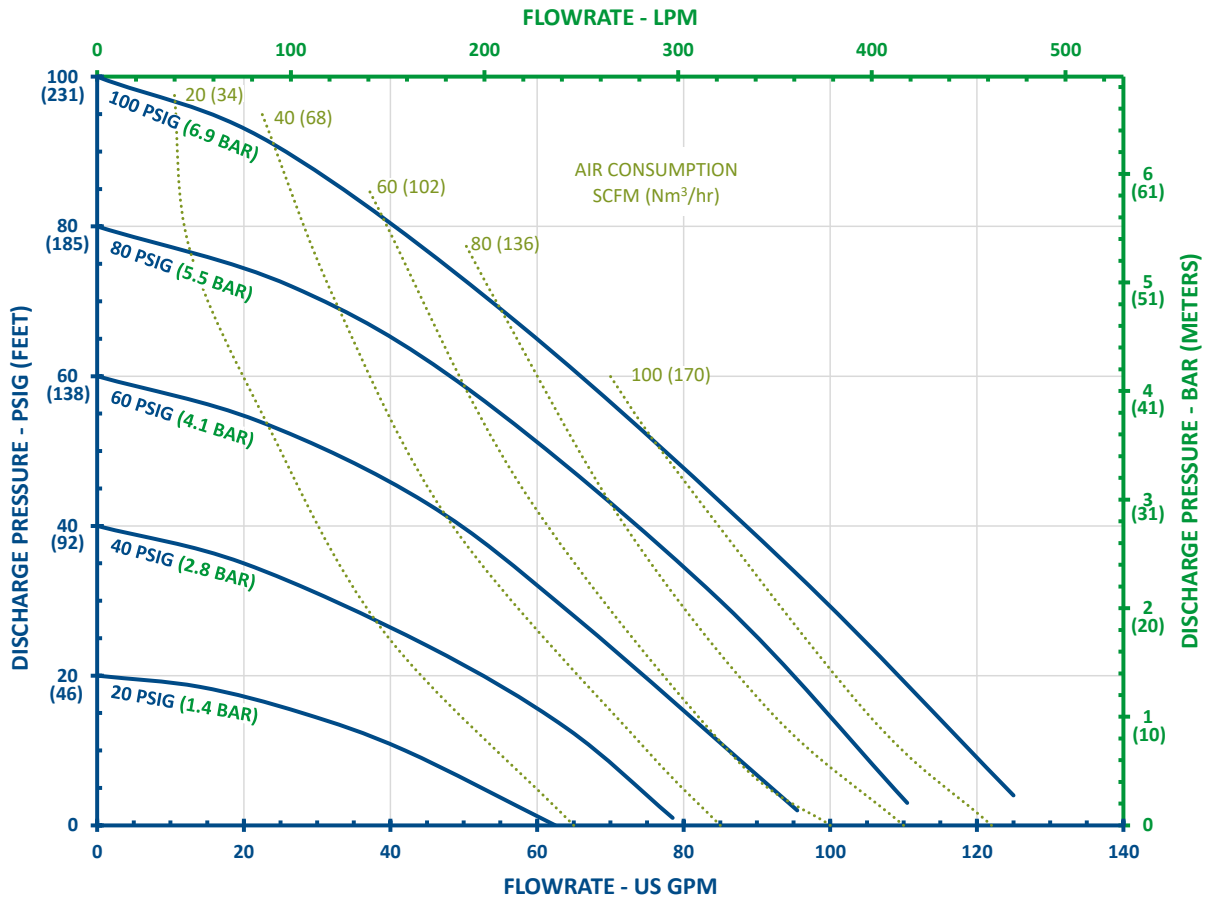

Dimensional Drawing

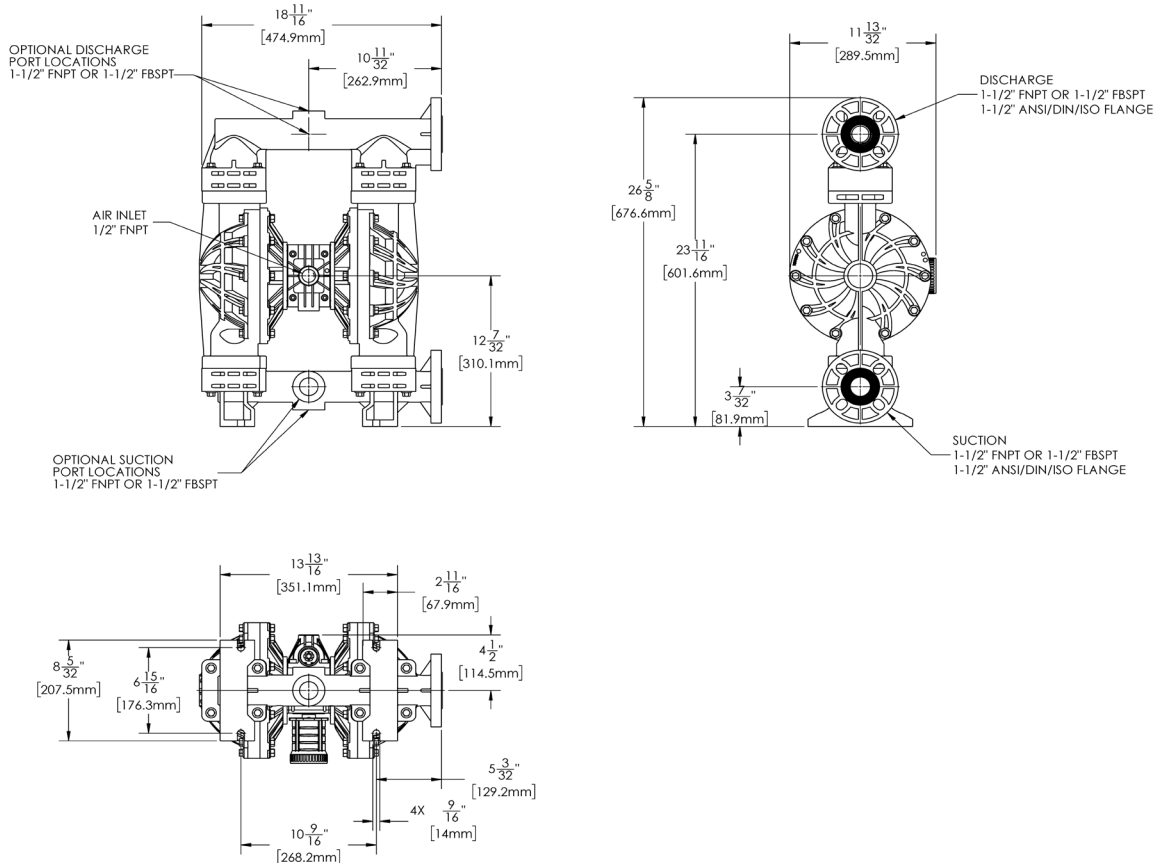

Installation Drawing

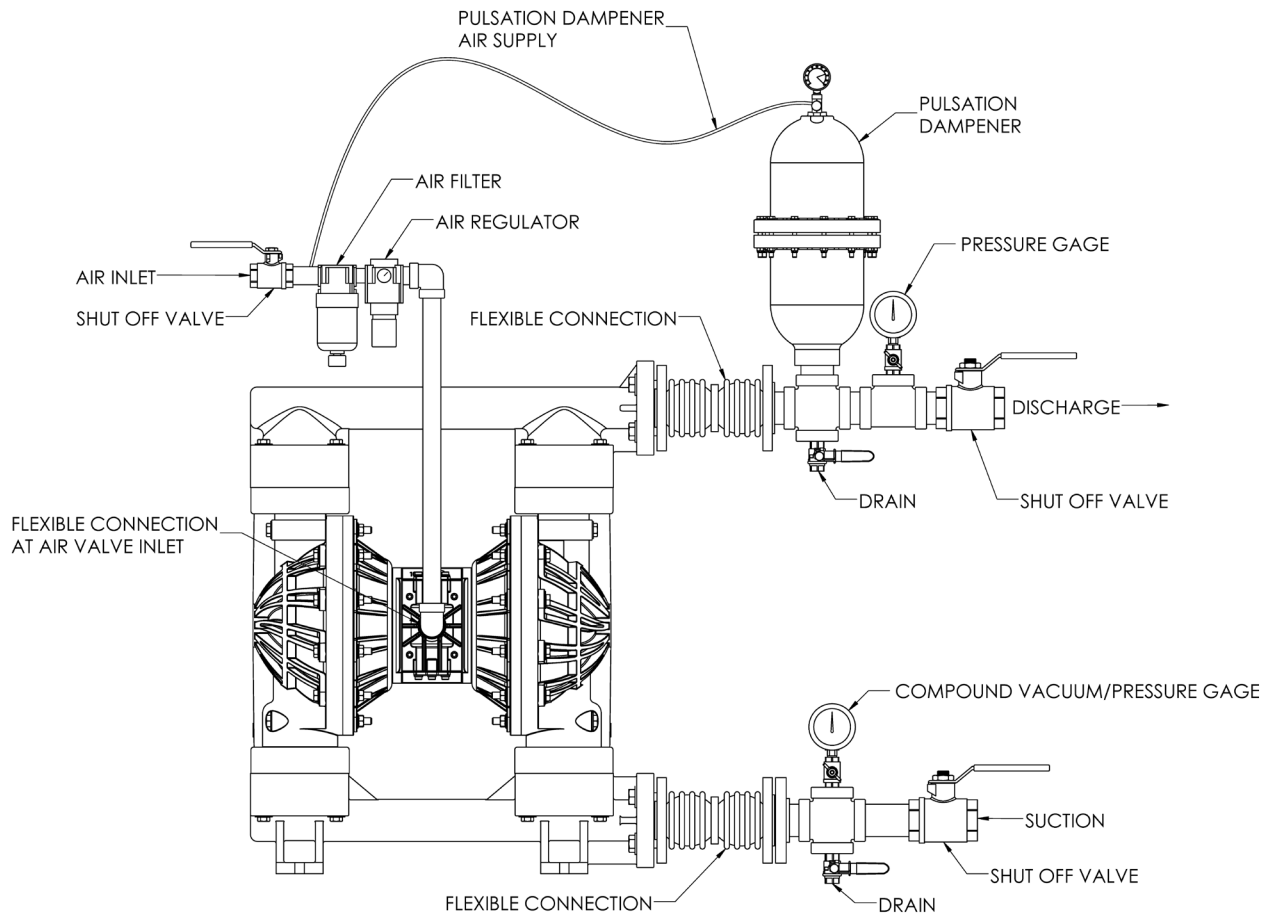

PUMP MUFFLER IS ON THE BACK SIDE OF THE PUMP.
IT CAN BE REMOVED AND EXHAUST CAN BE PIPED TO DESIRED LOCATION.

Installation / Operation Precautions

Installation and Start up

Install the pump in a vertical position or it may not prime properly. Pump should be located as close to the product being pumped as possible. Suction line length should be as short as possible and limit the number of fittings. Suction line diameter should not be reduced smaller than the suction diameter of the pump. When using rigid pipe run short sections of flexible hose or flexible connections between the pump & piping. Secure the pump to a suitable surface.

Air Supply

Connect the pump air inlet to an air supply with sufficient capacity to achieve desired performance. A pressure regulating valve should be installed to insure air supply pressure does not exceed recommended limits.

Air Valve Lubrication

No lubrication is required for the air distribution system.

Fasteners

Re-torque all fasteners before operation. Creep of housing and gasket materials may cause fasteners to loosen. Re-torque all fasteners to the torque specifications listed on the exploded view drawing in this manual.

Air Inlet & Priming

Pump will start to operate as soon as the shut-off valve is opened. It is recommended to open the shut-off valve slowly at first. Once the pump primes; the shut-off valve can be opened additionally to increase the pump's flow. If the pump is operating but not pumping any liquid see the troubleshooting section for tips & suggestions.

Accessories

Surge suppressors, spill stops & filter regulators are available and should be used with FTI AIR pumps.

Troubleshooting Tips & Suggestions

PUMP WILL NOT START OR CYCLE:

- Blocked liquid pipe or hose - Clean out or replace
- Clogged liquid chamber - Remove debris
- Diaphragm shaft bushing / o-ring leak - Replace o-rings
- Air valve carrier not shifting - Inspect, clean, re-oil with 10 wt. air tool oil. (aluminum air valve)
- Air valve carrier not shifting - Inspect, replace seals (polypropylene air valve)

ERRATIC CYCLING:

- Diaphragm failure - Replace diaphragm
- Valve ball not seating properly, worn or damaged – Inspect, remove debris or replace
- Leak in suction line - Inspect, repair or replace
- Diaphragm shaft bushing / o-ring leak - Replace o-rings
- Air valve carrier not shifting - Inspect, clean, re-oil with 10 wt. air tool oil. (aluminum air valve)
- Air valve carrier not shifting - Inspect, replace seals (polypropylene air valve)
- Over lubrication in air valve - Inspect, degrease, reuse. Adjust lubrication
- Excess moisture in air valve – Inspect, dry, reuse. Consider installing an air dryer
- For aluminum air valves, worn carrier or valve bore – measure carrier and valve bore, diametrical clearance should be between .0020” - .0035”. Replace worn components as needed
- For plastic air valves, worn carrier seals – replace carrier seals if there is no longer interference between seals and valve bore

PUMP CYCLES BUT WILL NOT PUMP:

- Too much suction lift - Reduce suction lift or fill liquid chambers with liquid
- Leak in suction line - Inspect, repair or replace
- Valve ball not seating properly, worn or damaged - Inspect, remove debris or replace
- Clogged suction pipe or hose - Inspect & clear
- Clogged strainer if used - Inspect & clear
- Diaphragm failure - Replace diaphragm

PUMPED LIQUID RELEASED FROM AIR EXHAUST

- Diaphragm failure - Replace diaphragm
- Outer plate unthreading - Tighten & re-torque

Maintenance

Recommended Tools for Servicing Pump

- 13 mm, 15 mm, & 17 mm box wrenches; (2) 30mm socket wrenches, snap ring pliers; 4, 6, & 8 mm hex wrenches, o-ring pick, & torque wrench.

Wet End Servicing (Installing Wet End Kit)

- Relieve airline pressure and fluid line pressures before conducting maintenance.
- The pump can be drained by turning it upside down and allowing fluid to drain into an appropriate container. Use proper safety equipment when conducting maintenance as internal components may still contain the pumped media.
- Lubricate all stainless steel to stainless steel fasteners to prevent galling. Torque values listed in the back of this manual are for lubricated fasteners.

Wet End Disassembly

1 Remove the (8) discharge manifold bolts & washers (items 12 & 13) from the discharge manifold (item 37) using a 17 mm wrench.



2 The discharge seat o-rings, valve seats, and valve balls (items 15, 16, & 17) can now be accessed and replaced if needed.

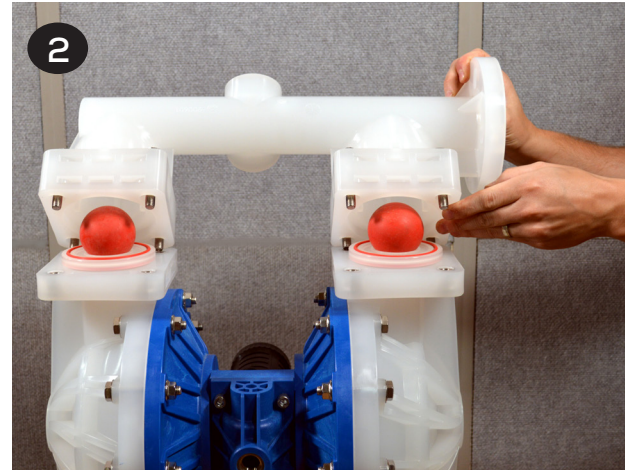

3 Repeat the above steps for the suction manifold (item 14). The seat o-rings, valve seats and valve balls (items 15, 16, & 17) are located in the liquid chambers (item 20).

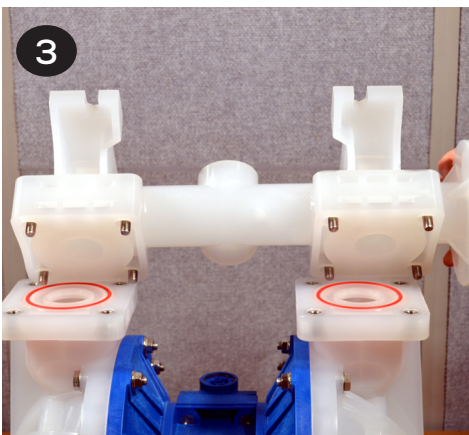

4 Remove both liquid chambers by removing the (10) bolts, washers & nuts (items 18, 19 & 28) on each liquid chamber using a 17mm wrench and nuts can be removed using a 15mm wrench. Inspect and replace diaphragms if needed.

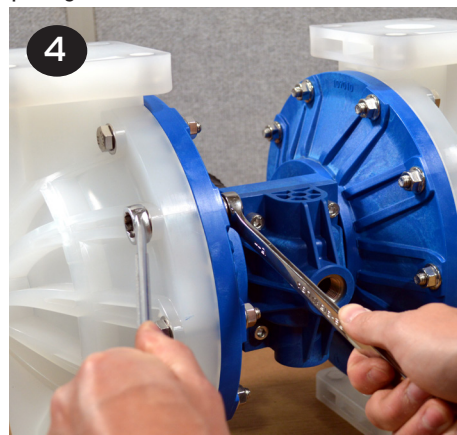

5 To remove the diaphragms (items 22/23), begin by loosening the (2) outer plates (item 21) using two 30 mm wrenches. Use 6-sided sockets or wrenches to prevent damage to the hex portion of the outer plate.



- 6** Remove the outer plate, diaphragm(s), and inner plate (items 21, 22/23 & 24) from the side that is loosened. Pull or push the shaft (item 32) and remaining plates and diaphragms out of the center section. If pulling, it may be easier to grip the diaphragm if it is inverted.

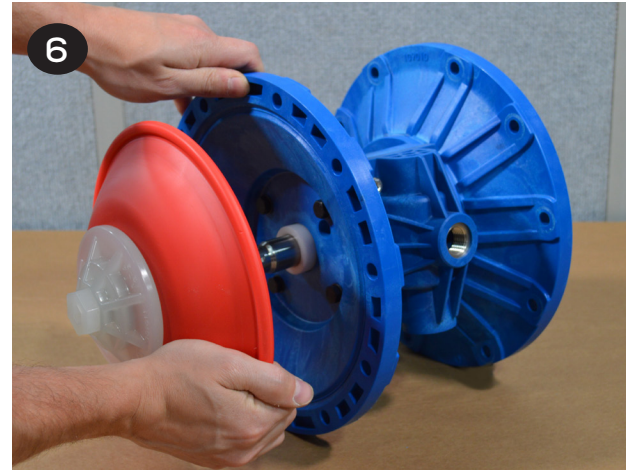
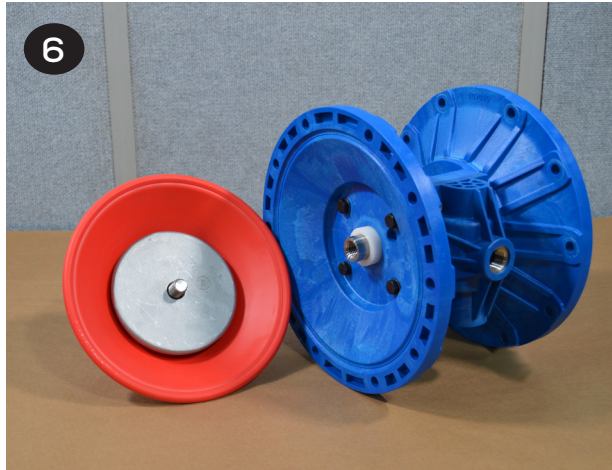

- 7** To remove the remaining diaphragm(s) (items 22/23) and plates (items 21 & 24) from the shaft (item 32), place the shaft in a vise fitted with soft jaws. Using a 6-sided 30mm wrench, remove the remaining diaphragm(s) and plates. Soft jaws are required to prevent damaging the shaft. A damaged shaft will result in accelerated o-ring wear. Jaws can be fitted with wood, plastic, rubber, or other soft material to prevent shaft damage.



After performing required maintenance, the pump can be reassembled. The pump can also be reassembled using the disassembly instructions in the reverse order as listed above. For detailed assembly instructions, follow steps in Wet End Reassembly section beginning on page 12.

Wet End Reassembly

1 Slide the center hole of one diaphragm (item 23) over the molded-in bolt of an outer plate (item 21). The air side of the diaphragm is labeled and should face away from the plastic portion of the outer plate. If the pump is fitted with PTFE diaphragms (item 22), first place a PTFE diaphragm over the molded in bolt of the outer plate (item 21). Then place the backup diaphragm (item 23) on the outer plate. The shape of the PTFE diaphragm and back up diaphragm should roughly conform to one another. See the exploded view drawing for proper orientation.



2 Place the inner plate (item 24) over the molded-in bolt. Ensure the round recess in the plate faces the diaphragm (item 23).



3 Apply a couple drops of a medium strength thread locker, such as Loctite® 246, to the molded in outer plate bolt (item 21). Thread the shaft (item 32) onto the molded in bolt until it is snug to the flat back side of the inner plate (item 24).



4 The shaft (item 32) and shaft o-rings (item 31) should retain the lubricant that was factory applied. If they appear dry, apply a light coat of lithium thickened grease. Avoid over lubrication as it can cause decreased performance of the air distribution system.

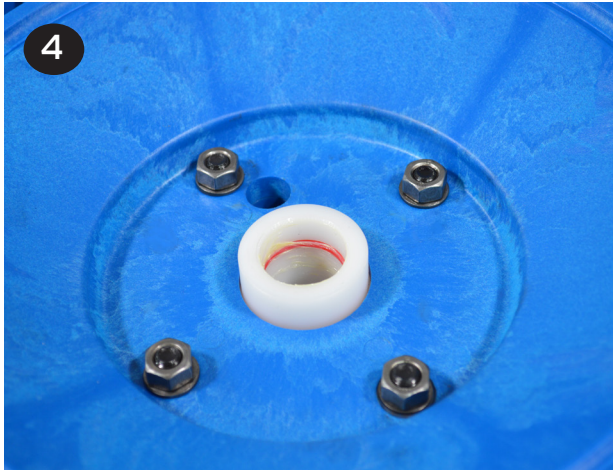

5 Push the shaft (item 32) through the center of the shaft bushing (item 30). It is normal for this to be a tight fit, especially if the shaft and shaft o-rings (item 31) are in good condition.

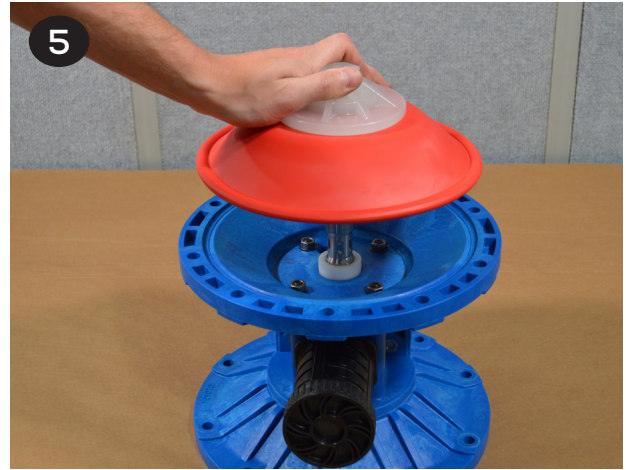

6 It may be easier to thread the molded in bolt into the shaft if the diaphragm(s) is inverted on one or both sides. This can be done by hand.

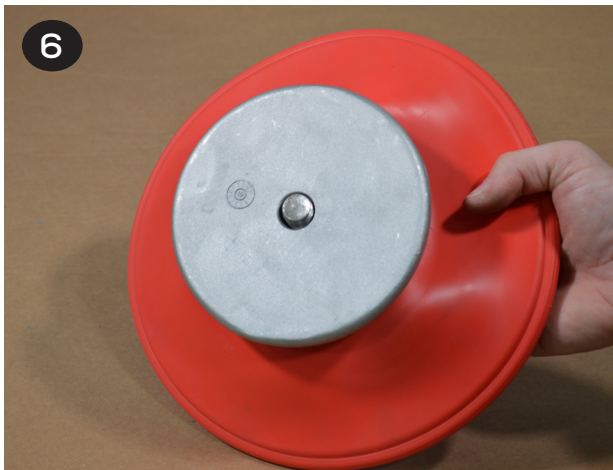

7 The other diaphragm(s) (items 22/23) and inner/outer plates (items 21 & 24) can be installed onto the opposite end of the shaft (item 32).

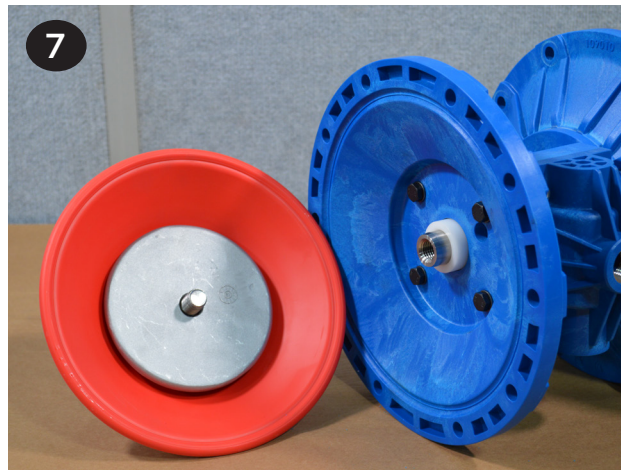

8 Tighten and torque the outer plates (item 21).

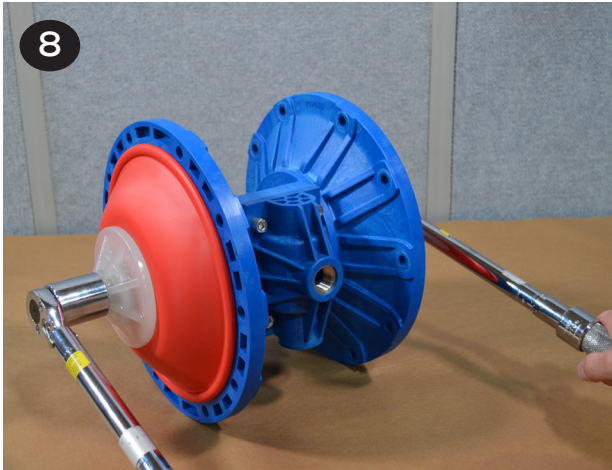

9 Install the liquid chambers (item 20) by placing one side over the diaphragm. Start all bolts, washers & nuts (items 18, 19, & 28) before tightening and torquing. Torque all fasteners in a star pattern. Repeat to install the second liquid chamber. Ensure both chambers are orientated the same and that the inlet and outlet ports are vertical when facing the front of the pump as shown.

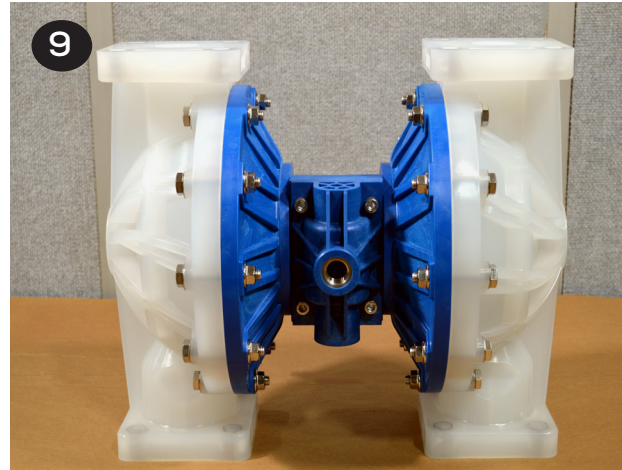

10 Flip the pump upside down and drop the suction valve balls (item 17) into the liquid chamber (item 20) ball cages.

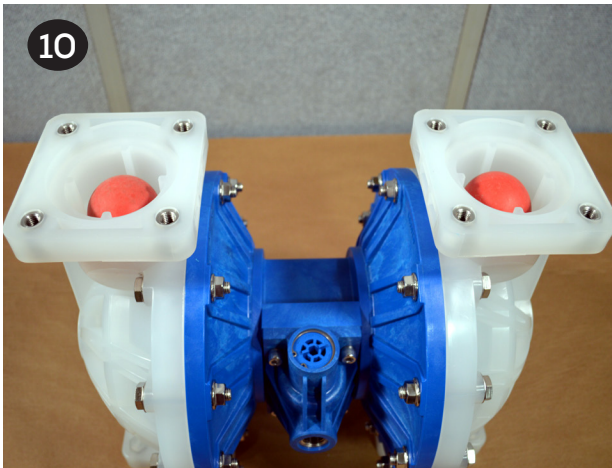

11 Place the valve seat o-rings (item 15) into each side of the valve seats (item 16). Place the valve seats into the counterbores of the liquid chambers (item 20). Valve seats are symmetrical.

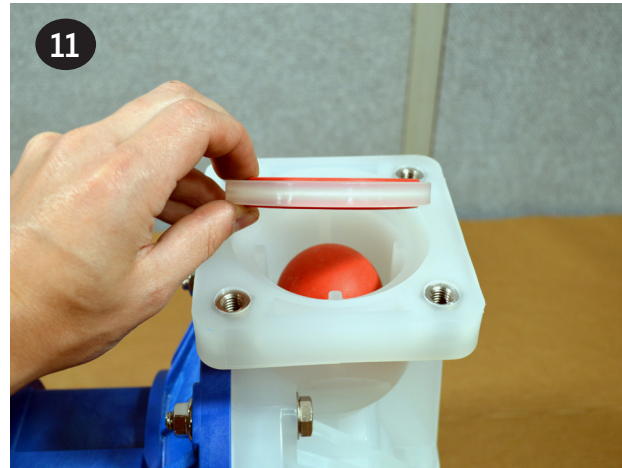

12 Place the suction manifold atop the pump and install, tighten and torque the (8) manifold bolts & washers (items 12 & 13).

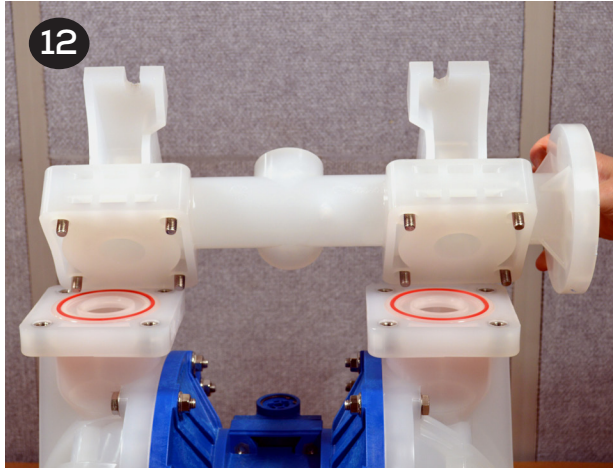

13 Stand the pump upright onto the suction manifold feet (item 14). Place the valve seat o-rings (item 15) into each side of the valve seats (item 16). Place the valve seats on the liquid chambers (item 20).

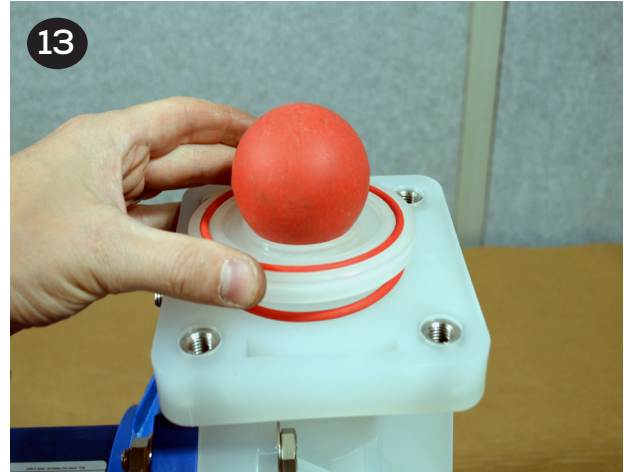

14 Place the valve balls (item 17) on the valve seats and discharge manifold (item 37) atop the components that are stacked on top of the liquid chambers. Install, tighten and torque the (8) manifold bolts & washers (items 12 & 13).

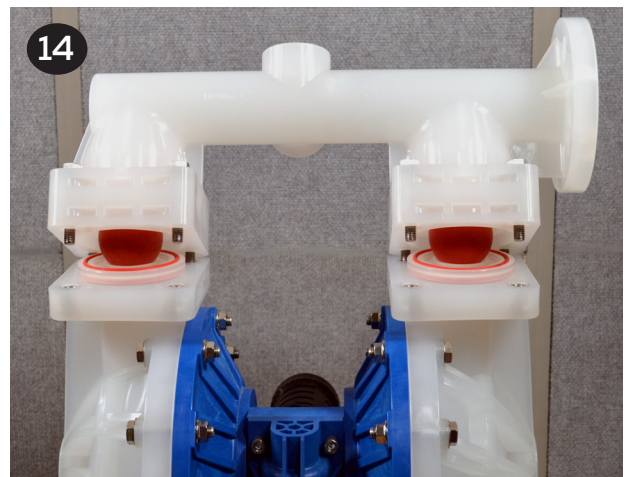

**Air End Servicing (Installing Air End Kit)
Shaft, Bushing, & O-ring Replacement**

• Follow steps 1 – 7 in the Wet End Servicing disassembly section to access the shaft bushing (item 30) and o-rings (items 29 & 31).

1 Remove both air chambers by removing the (4) bolts and (4) nuts using a 13mm (or ½”) wrench.



2 Remove and set aside the air valve (item 3) using a 6 mm hex wrench (see “Valve Replacement” section for more details). The shaft bushings (item 30) can be removed by placing a large socket between the two bushings. Place an extension into the socket from one side of the center section. Tap with a rubber mallet to remove the bushing. Repeat for the remaining bushing.

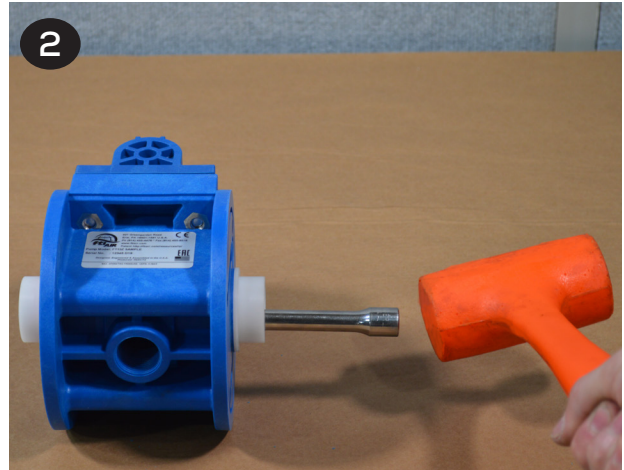

3 Use the supplied grease packets to lightly grease the OD and ID o-rings (items 29 & 31) that come preinstalled in the new shaft bushings supplied in air end kits.

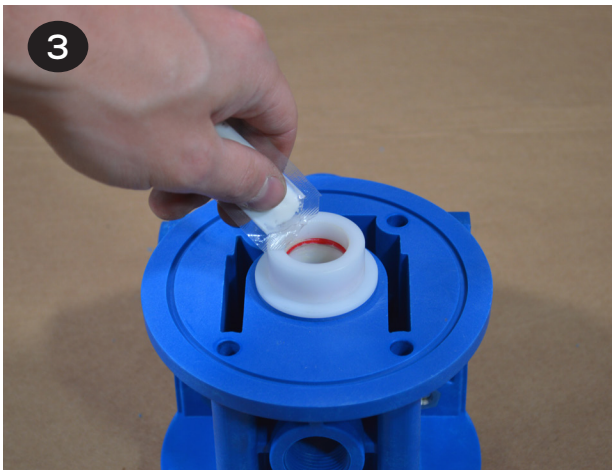

4 Insert both bushings into the center section. Ensure the bushing is fully installed.

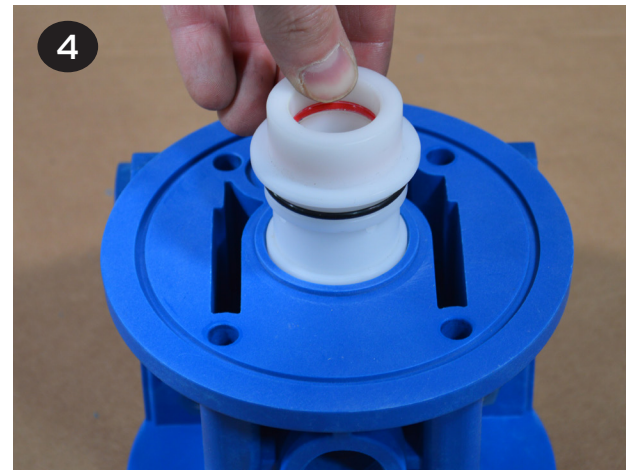

5 Inspect the shaft (item 32) for damage. It is common for shafts to become grooved during service. Grooving is normally caused by carbonized oil and/or abrasive foreign material getting trapped between the seal and the shaft. Over time, deep grooves can form in the shaft. When that occurs, it is recommended that the shaft be replaced.



6 After determining if the condition of the shaft is acceptable, ensure both center section o-rings (items 33 & 34) are in place on both sides of the center section.

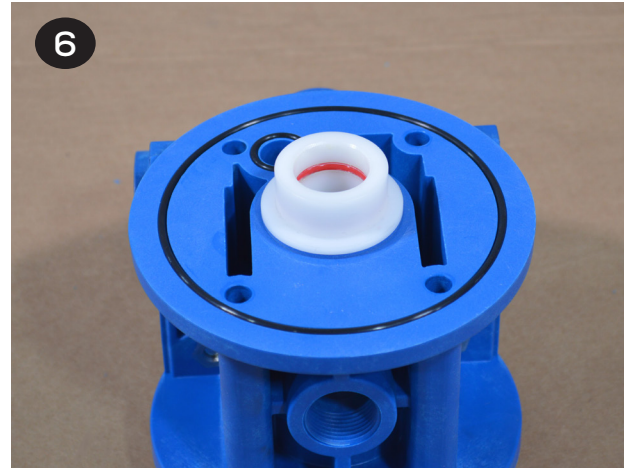

7 Install both air chambers (item 27) by placing one side on top of the center section (item 35). Ensure the air path hole of the center section lines up with the through hole in the air chamber. Insert the (4) bolts & washers (items 25 & 26) through the air chamber and center section.



8 Flip the components over and place the remaining air chamber on the center section. Thread the nuts & washers onto the bolts (items 25, 26 & 38). Tighten and torque the fasteners.



• To rebuild the rest of the pump, follow steps 5 – 16 in the Wet End Servicing – Wet End Reassembly section.

Air Valve O-Ring Replacement

1 Plastic Air Valve - To replace the valve cap o-ring remove the retaining ring (item 10), then pull the valve cap (item 9) straight up. The use of an M8 bolt, vice grip, and pry bars may be necessary. See 1 and 1A pictures below.



2 Plastic Air Valve - Remove and replace o-rings (item 8). Insert cap (item 9) and push down until groove for the retaining ring is visible. Install retaining ring (item 10). Make sure to lubricate the o-rings prior to inserting into the valve body with a compatible lubricant.

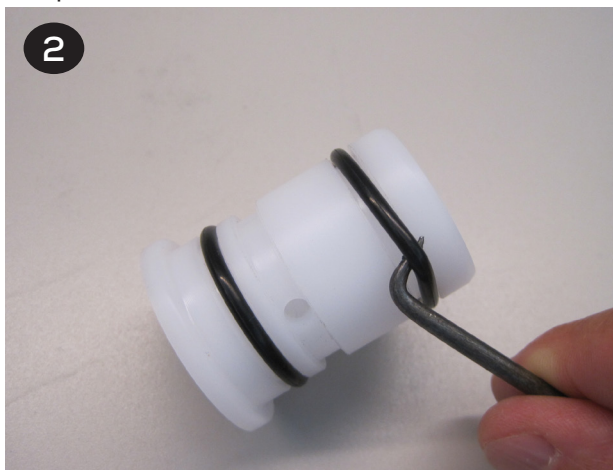

1 Aluminum Air Valve - To replace the valve cap o-rings (item 8), remove the (3) button head cap screws (item 11) using a 4 mm hex wrench. Repeat for the remaining cap.

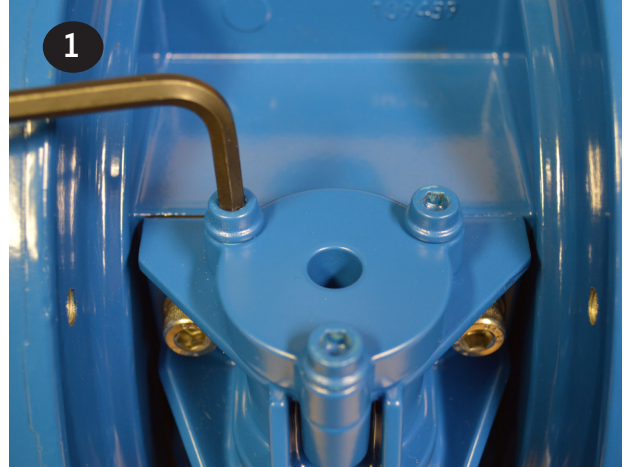

2 Aluminum Air Valve - Remove and replace o-ring (item 8). Install cap (item 9), tighten, and torque the valve cap screws (item 11). Repeat for the remaining cap.

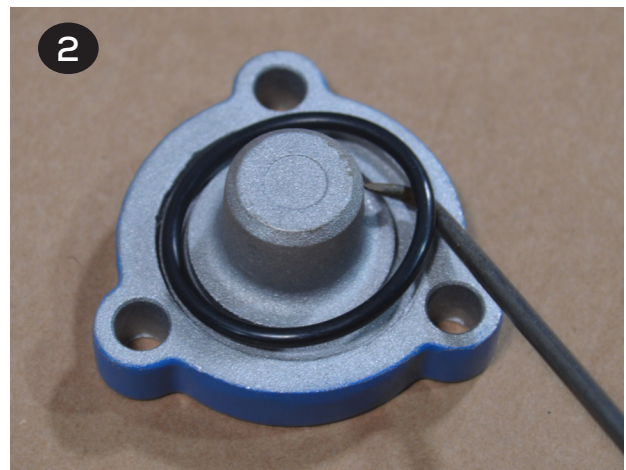

Valve Gasket Replacement

1 Remove the valve body (item 3) by removing the (4) socket head cap screws & lock washers (items 1 & 2) that attach the valve body to the center section (item 35) with a 6 mm hex wrench.

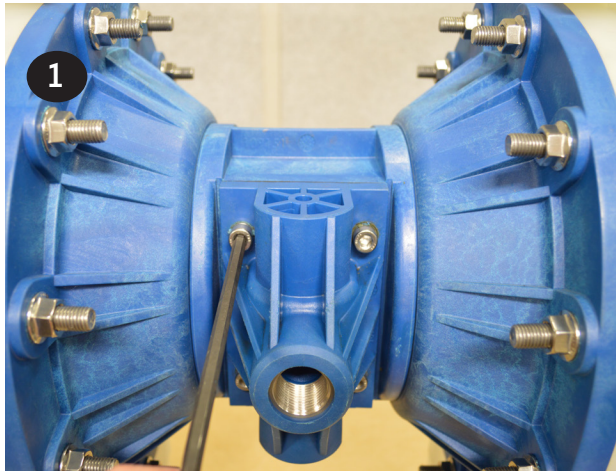

2 Pull the valve body and gasket (items 3 & 6) off the front of the center section (item 35).

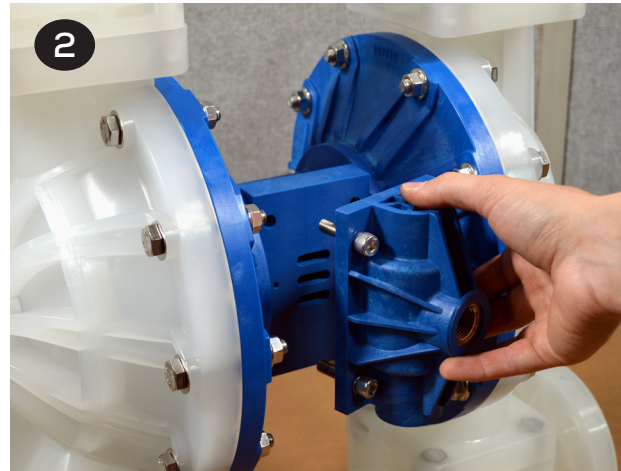

3 Place the new gasket (item 6) on the air valve (item 3) and ensure the slots in the gasket align with the slots in the air valve and valve plate (item 5).

Air Valve Slide, Plate & Gasket Orientation: If the valve plate (item 5) and slide valve (item 4) are removed, ensure they are installed in the proper orientation. The flat face of the slide valve sits in the pocket of the valve carrier (item 7) so that the square cut out on the slide valve faces the smooth polished side of the valve plate.

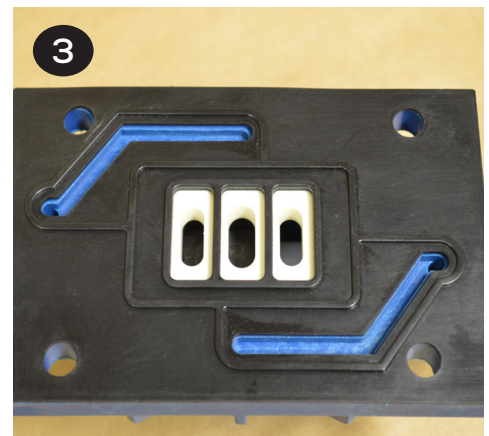
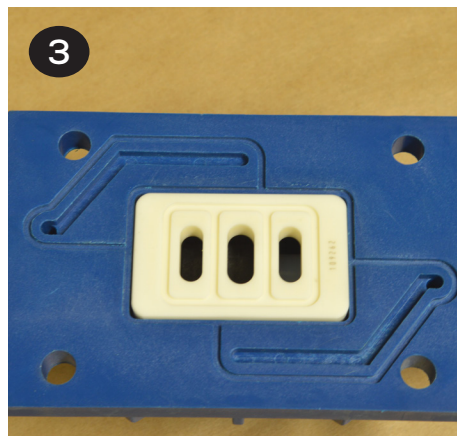
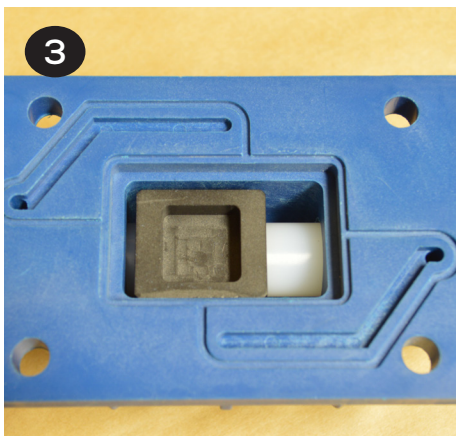

4 Insert the (4) cap screws (item 1) through the valve body and gasket (items 3 & 6) and place onto the center section (item 35). Ensure the slide valve and valve plate (items 4 & 5) are in place and the valve sits flat on the center section.



5 Tighten and torque the (4) cap screws into the center section.



Replacement Air Valve Kit Installation

1. Remove the valve that is to be replaced by removing the (4) socket head cap screws with a 6 mm hex wrench that attaches the valve body to the center section.
 2. Save the (4) cap screws & (4) lock washers. All other valve components can be discarded.
 3. Remove the packing tape that holds the air valve components in place during shipping.
- Follow steps 3 – 7 in the Valve Gasket Replacement section of Air End Servicing above.

Exploded View & Spare Parts List

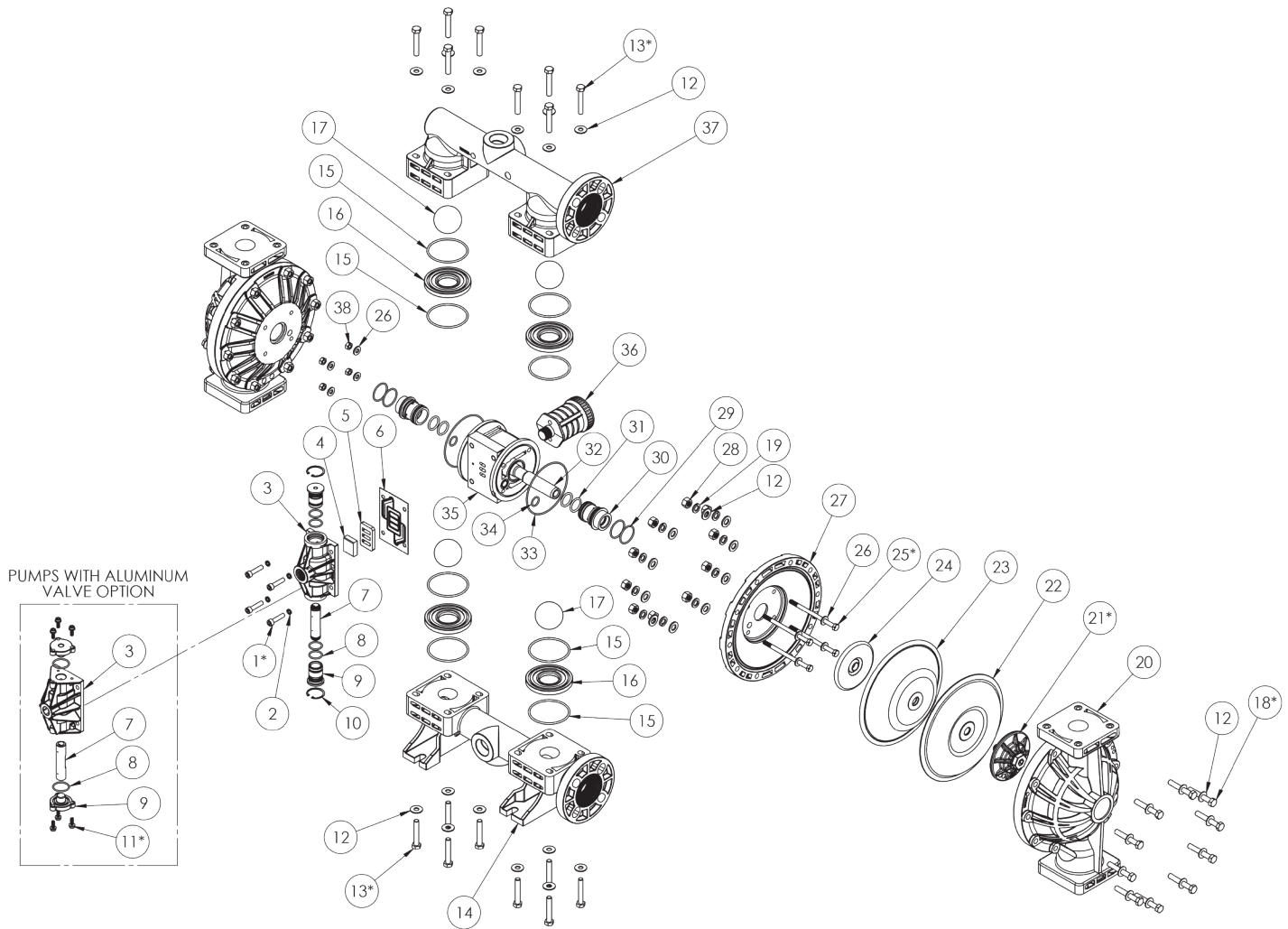

ITEM	DESCRIPTION	PART NO.	QTY	KIT
1	CAP SCREW, SOCKET HEAD, M8-1.25 X 35MM SSTL	105589	4	
2	WASHER, LOCK HIGH COLLAR, M8 SSTL	109518	4	
3	VALVE BODY	SEE AIR VALVE TABLES		
4	SLIDE VALVE	109843	1	V1/V2
5	VALVE PLATE	109845	1	V1/V2
6	GASKET, AIR VALVE	109266	1	A1/A2/V1/V2
7	VALVE CARRIER	SEE AIR VALVE TABLES		
8	O-RING, VALVE CAP	SEE AIR VALVE TABLES		
9	VALVE CAP	SEE AIR VALVE TABLES		
10	RETAINING RING, VALVE CAP	SEE AIR VALVE TABLES		
11	CAP SCREW, BUTTON HEAD, M6-1.0 X 16MM SSTL	SEE AIR VALVE TABLES		
12	WASHER, FLAT 3/8" ANSI B SSTL	111390	56	
13	CAP SCREW, HEX HD, M10-1.5 X 60MM SSTL	209027	16	

ITEM	DESCRIPTION	PART NO.	QTY	KIT
14	MANIFOLD, SUCTION, POLYPROPYLENE NPT / FLANGE	109003-1	1	
	MANIFOLD, SUCTION, POLYPROPYLENE BSPT / FLANGE	109003-2		
	MANIFOLD, SUCTION, POLYPROPYLENE NPT CENTER HORIZONTAL	109057		
	MANIFOLD, SUCTION, POLYPROPYLENE NPT CENTER VERTICAL	109057-1		
	MANIFOLD, SUCTION, POLYPROPYLENE BSPT CENTER HORIZONTAL	109057-2		
	MANIFOLD, SUCTION, POLYPROPYLENE BSPT CENTER VERTICAL	109057-3		
	MANIFOLD, SUCTION, PVDF, NPT / FLANGE	109003-3		
	MANIFOLD, SUCTION, PVDF, BSPT / FLANGE	109003-4		
	MANIFOLD, SUCTION, PVDF NPT CENTER HORIZONTAL	109057-4		
	MANIFOLD, SUCTION, PVDF NPT CENTER VERTICAL	109057-5		
	MANIFOLD, SUCTION, PVDF BSPT CENTER HORIZONTAL	109057-6		
	MANIFOLD, SUCTION, PVDF BSPT CENTER VERTICAL	109057-7		
15	O-RING, VALVE SEAT, NEOPRENE	109036	8	W
	O-RING, VALVE SEAT, BUNA	109308		
	O-RING, VALVE SEAT, EPDM	109037		
	O-RING, VALVE SEAT, PTFE	109038		
	O-RING, VALVE SEAT, FKM	109323		
	O-RING, VALVE SEAT, FEP ENCAPSULATED FKM	109536		
	O-RING, VALVE SEAT, POLYURETHANE	109537		
	O-RING, VALVE SEAT, SANTOPRENE	109538		
16	VALVE SEAT, PTFE	109018	4	W
	VALVE SEAT, ALUMINUM	109019		
	VALVE SEAT, STAINLESS STEEL	109020		
	VALVE SEAT, NEOPRENE	109021-1		
	VALVE SEAT, BUNA	109021-2		
	VALVE SEAT, EPDM	109021-3		
	VALVE SEAT, FKM	109021-4		
	VALVE SEAT, SANTOPRENE	109022-1		
	VALVE SEAT, HYTREL	109022-2		
	VALVE SEAT, POLYURETHANE	109022-3		
	VALVE SEAT, FDA SANTOPRENE	109022-4		
	VALVE SEAT, FDA HYTREL	109022-5		
	VALVE SEAT, POLYPROPYLENE	109030		
	VALVE SEAT, PVDF	109030-1		
17	VALVE BALL, NEOPRENE	109025-1	4	W
	VALVE BALL, BUNA	109025-2		
	VALVE BALL, EPDM	109025-3		
	VALVE BALL, FKM	109025-4		
	VALVE BALL, SANTOPRENE	109026-1		
	VALVE BALL, FDA SANTOPRENE	109026-4		
	VALVE BALL, PTFE	109027		
	VALVE BALL, WEIGHTED PTFE	109031		
	VALVE BALL, 316 STAINLESS STEEL	109032		
18	CAP SCREW, HEX HD, M10-1.5 X 75MM SSTL	111388	20	
19	WASHER, LOCK M10 SSTL	105757	20	

ITEM	DESCRIPTION	PART NO.	QTY	KIT
20	LIQUID CHAMBER, POLYPROPYLENE	109767-18	2	
	LIQUID CHAMBER, PVDF	109767-19		
21	OUTER PLATE, POLYPROPYLENE	109011-1	2	
	OUTER PLATE, PVDF	109011-2		
22	DIAPHRAGM, PTFE	109017	2	W
23	DIAPHRAGM, NEOPRENE	109023-1	2	W
	DIAPHRAGM, BUNA	109023-2		
	DIAPHRAGM, EPDM	109023-3		
	DIAPHRAGM, FKM	109023-4		
	DIAPHRAGM, SANTOPRENE	109023-5		
	DIAPHRAGM, HYTREL	109023-6		
	DIAPHRAGM, POLYURETHANE	109023-7		
	DIAPHRAGM, FDA SANTOPRENE	109023-8		
	DIAPHRAGM, FDA HYTREL	109023-9		
24	INNER PLATE, ALUMINUM	109169-1	2	
	INNER PLATE, STAINLESS STEEL	109716-1		
25	CAP SCREW, HEX HEAD, M8-1.25 X 130MM BLACK	209021	4	
26	WASHER, FLAT M8 BLACK	109469	8	
27	AIR CHAMBER, GF POLYPROPYLENE	109010	2	
28	NUT, HEX, M10-1.5 SSTL	107825	20	
29	O-RING, SHAFT	109424	4	A1/A2
30	SHAFT BUSHINGS W/ O-RINGS (ITEMS 29 & 31) INCLUDES BOTH BUSHINGS	109069	1	A1
31	O-RING, BUSHING OD	109420	4	A1/A2
32	SHAFT	109015	1	
33	O-RING, CENTER SECTION, LARGE	108588	2	A1
34	O-RING, CENTER SECTION, SMALL	109039	2	A1
35	CENTER SECTION, GF POLYPROPYLENE	109009	1	
36	MUFFLER, GF POLYPROPYLENE	109562	1	
	MUFFLER, STEEL	109700		
	MUFFLER, STEEL, LARGE	109794		
37	MANIFOLD, DISCHARGE, PP NPT / FLANGE	109006-1	1	
	MANIFOLD, DISCHARGE, PP BSPT / FLANGE	109006-2		
	MANIFOLD, DISCHARGE, PP NPT CENTER HORIZONTAL	109056		
	MANIFOLD, DISCHARGE, PP NPT CENTER VERTICAL	109056-1		
	MANIFOLD, DISCHARGE, PP BSPT CENTER HORIZONTAL	109056-2		
	MANIFOLD, DISCHARGE, PP BSPT CENTER VERTICAL	109056-3		
	MANIFOLD, DISCHARGE, PVDF, NPT / FLANGE	109006-3		
	MANIFOLD, DISCHARGE, PVDF, BSPT / FLANGE	109006-4		
	MANIFOLD, DISCHARGE, PVDF NPT CENTER HORIZONTAL	109056-4		
	MANIFOLD, DISCHARGE, PVDF NPT CENTER VERTICAL	109056-5		
	MANIFOLD, DISCHARGE, PVDF BSPT CENTER HORIZONTAL	109056-6		
	MANIFOLD, DISCHARGE, PVDF BSPT CENTER VERTICAL	109056-7		
38	NUT, HEX, M8-1.25 BLACK	109474	4	

KIT COLUMN KEY:

A1 - PARTS SUPPLIED IN PLASTIC VALVE AIR END KIT 109907

V1 - PARTS SUPPLIED IN PLASTIC REPLACEMENT VALVE KIT 109051-1

W - PARTS SUPPLIED IN A WET SIDE KITS

A2 - PARTS SUPPLIED IN ALUMINUM VALVE AIR END KIT 109055-2

V2 - PARTS SUPPLIED IN ALUMINUM REPLACEMENT VALVE KIT 109050

PUMPS FITTED WITH GFRPP AIR VALVES: FT15Z - P- - - -				
ITEM	DESCRIPTION	PART NO.	QTY	KIT
3	VALVE BODY	109903	1	V1
7	VALVE CARRIER WITH SEALS	111365	1	V1
8	O-RING, VALVE CAP	109891	4	A1/V1
9	VALVE CAP - DELRIN	109889	2	V1
10	RETAINING RING, HO-137SSTL	109647	2	V1

PUMPS FITTED WITH ALUMINUM AIR VALVES FT15Z -A- - - -				
ITEM	DESCRIPTION	PART NO.	QTY	KIT
3	VALVE BODY, ALUMINUM	SEE ITEM 40	1	
7	VALVE CARRIER, ALUMINUM	109844	1	
8	O-RING, VALVE CAP	109415	2	A2
9	VALVE CAP, ALUMINUM	SEE ITEM 40	2	
11	CAP SCREW, BUTTON HEAD, M6-1.0 X 16MM SSTL	109513	6	
40	CONTAINS ITEMS 3, 7, 8, 9, AND 11	109049	1	V2

FT15ZP & FT15ZV Maximum Torque Settings*	
Item #	Torque
1	8.5 N-m (75 in-lbs)+
11	8 N-m (72 in-lbs)
13	38 N-m (336 in-lbs)+
18	38 N-m (336 in-lbs)+
21	95 N-m (840 in-lbs)+
25	20 N-m (180 in-lbs)

Asterisk (*) from the exploded view diagram indicates fasteners to be torqued. Stainless steel to stainless steel fasteners should be lubricated to prevent galling. A Plus sign (+) on the above torque values indicates a lubricated fastener.

Warranty

FTI AIR A Division of Finish Thompson, Inc (manufacturer) warrants this pump product to be free of defects in materials and workmanship for a period of five years from date of purchase by original purchaser. If a warranted defect, which is determined by manufacturer's inspection, occurs within this period, it will be repaired or replaced at the manufacturer's option, provided (1) the product is submitted with proof of purchase date and (2) transportation charges are prepaid to the manufacturer.

Liability under this warranty is expressly limited to repairing or replacing the product or parts thereof and is in lieu of any other warranties, either expressed or implied. This warranty does not apply to normal wear of the product or components. This warranty does not apply to products or parts broken due to, in whole or in part, accident, overload, abuse, chemical attack, tampering, or alteration. The warranty does not apply to any other equipment used or purchased in combination with this product. The manufacturer accepts no responsibility for product damage or personal injuries sustained when the product is modified in any way. If this warranty does not apply, the purchaser shall bear all cost for labor, material and transportation.

Manufacturer shall not be liable for incidental or consequential damages including, but not limited to process down time, transportation costs, costs associated with replacement or substitution products, labor costs, product installation or removal costs, or loss of profit. In any and all events, manufacturer's liability shall not exceed the purchase price of the product and/or accessories