

BALDOR® • ***RELIANCE***

Product Information Packet

CEWDM3711T

10HP,3490RPM,3PH,60HZ,215TC,3728M,TEFC,F

Part Detail							
Revision:	S	Status:	PRD/A	Change #:		Proprietary:	No
Type:	AC	Prod. Type:	3728M	Elec. Spec:	37WGS864	CD Diagram:	CD0005
Enclosure:	TEFC	Mfg Plant:		Mech. Spec:	37H887	Layout:	37LYH887
Frame:	215TC	Mounting:	F1	Poles:	02	Created Date:	12-29-2010
Base:	RG	Rotation:	R	Insulation:	F	Eff. Date:	11-17-2016
Leads:	9#14					Replaced By:	
Literature:		Elec. Diagram:					

Nameplate NP1669L										
CAT.NO.	CEWDM3711T									
SPEC.	37H887S864G1									
HP	10									
VOLTS	230/460									
AMP	23.6/11.8									
RPM	3490									
FRAME	215TC				HZ	60			PH	3
SER.F.	1.15		CODE	G	DES	B		CLASS	F	
NEMA-NOM-EFF	90.2		PF	87						
RATING	40C AMB-CONT									
CC	010A				USABLE AT 208V	24.9				
DE	6307				ODE	6206				
ENCL	TEFC		SN							
BLANK										

Parts List		
Part Number	Description	Quantity
SA214691	SA 37H887S864G1	1.000 EA
RA201893	RA 37H887S864G1	1.000 EA
36FN3000C02	EXFN, PLASTIC, 5.25 OD, 1.175 ID	1.000 EA
HW3200A01	3/8-16X3/4 I-BLT WELDED F/S	1.000 EA
37CB3005A04W	CASTING W/.75 NPT@6(MACH WHITE)	1.000 EA
37GS1025	37 MOLDED GASKET W/LIP, LEAD SEAL	1.000 EA
51XW2520A12	.25-20 X .75, TAPTITE II, HEX WSHR SLTD	2.000 EA
HA5027A01	HA4066A01 T-DRAIN X2 BAGGED	1.000 EA
11XW1032G06	10-32 X .38, TAPTITE II, HEX WSHR SLTD U	1.000 EA
37EP3101A94MW	FRONT TEFC L&M 206 BRG W/O GR SR (WHITE)	1.000 EA
HW4032A01	BLACK DRAIN PLUG FOR WASH DOWN MOTORS	3.000 EA
HW5100A06	W2420-025 WVY WSHR (WB)	1.000 EA
37EP3300A23MW	WHITE EPOXY EP MACH COMPL	1.000 EA
HW4032A01	BLACK DRAIN PLUG FOR WASH DOWN MOTORS	3.000 EA
HW4600B51	SEAL 1.375 X 2.125 X 0.313 SINGLE LIP DB	1.000 EA
10XN2520S30	1/4-20 X 1 7/8 HEX HEAD SS	4.000 EA
XY3118S12	5/16-18 HEX NUT, STAINLESS STEEL	4.000 EA
07FH4011	WASHDOWN IEC FH W/PRIMED	1.000 EA
11XW1032S06	10-32 X .38, TAPTITE II, HEX WSHR SLTD U	3.000 EA
HW4600B74	V-RING SLINGER 1.125 X 1.445 X .24 VITON	1.000 EA
HW4600B31SP	V-RING SLINGER 1.438 X 1.758 X .24 VITON	1.000 EA
37CB4512	CONDUIT BOX LID FOR WASHDOWN 37 FRAME	1.000 EA
37GS1008A02	37 GS FOR CB LID - WHITE NEOPRENE	1.000 EA
59XW0832S07	TAPTITE II, HEX WSHR UNSLTD SER, 410 S.S.,	4.000 EA

Parts List (continued)		
Part Number	Description	Quantity
HW2502F21	#303 SS,SQ KEY 5/16 X 2.375	1.000 EA
HA7000A02	KEY RETAINER RING, 1 1/8 DIA, 1 3/8 DIA	1.000 EA
MJ5001A27	32220KN GRAY SEALER *MIN BUY 4 QTS=1GAL	0.001 QT
MJ5001A02	732 CL SEALANT 3 OZ DIXIE BEARING 289100	0.001 EA
85XU0407S04	4X1/4 U DRIVE PIN STAINLESS	2.000 EA
LB1115N	LABEL,LIFTING DEVICE (ON ROLLS)	1.000 EA
LB1164	LABEL,WARNING AND DRAIN	1.000 EA
MJ1000A02	GREASE, POLYREX EM EXXON (USe 4824-15A)	0.050 LB
51XB1214A20	12-14X1.25 HXWSSLD SERTYB	1.000 EA
MG1025Z02	ACTIVATOR WILKOFAS 060.02HF	0.010 GA
MG1025W01	WILKOFAS 781.01, SIGNAL WHITE #9003	0.028 GA
HA3104S14	300UBOLT 12.125LG SS	4.000 EA
LC0005	CONN.DIA.,TY M,9-LD,DUAL VOLT,REVERSING	1.000 EA
NP1669L	SS WD SUPER-E UL CSA-EEV PREM REV MTG	1.000 EA
G0PA1000	PKG GRP, PRINT PK1026A06	1.000 EA
MN416A01	TAG-INSTAL-MAINT no wire (1200/bx) 11/14	1.000 EA

AC Induction Motor Performance Data

Record # 53399 - Typical performance - not guaranteed values

Winding: 37WGS864-R028	Type: 3728M	Enclosure: TEFC
-------------------------------	--------------------	------------------------

Nameplate Data				460 V, 60 Hz: High Voltage Connection	
Rated Output (HP)	10			Full Load Torque	15 LB-FT
Volts	230/460			Start Configuration	direct on line
Full Load Amps	23.6/11.8			Breakdown Torque	45.7 LB-FT
R.P.M.	3490			Pull-up Torque	21.9 LB-FT
Hz	60	Phase	3	Locked-rotor Torque	25.4 LB-FT
NEMA Design Code	B	KVA Code	G	Starting Current	76.1 A
Service Factor (S.F.)	1.15			No-load Current	4.12 A
NEMA Nom. Eff.	90.2	Power Factor	87	Line-line Res. @ 25°C	0.991 Ω
Rating - Duty	40C AMB-CONT			Temp. Rise @ Rated Load	79°C
S.F. Amps				Temp. Rise @ S.F. Load	98°C
				Locked-rotor Power Factor	33.1
				Rotor inertia	0.255 LB-FT ²

Load Characteristics 460 V, 60 Hz, 10 HP

% of Rated Load	25	50	75	100	125	150	S.F.
Power Factor	53	74	84	87	89	89	88
Efficiency	86.7	91	91.4	90.6	89.1	87.3	90
Speed	3575	3547	3516	3482	3445	3401	3464
Line amperes	4.94	6.85	9.1	11.8	14.7	18	13.5

Performance Graph at 460V, 60Hz, 10.0HP Typical performance - Not guaranteed values

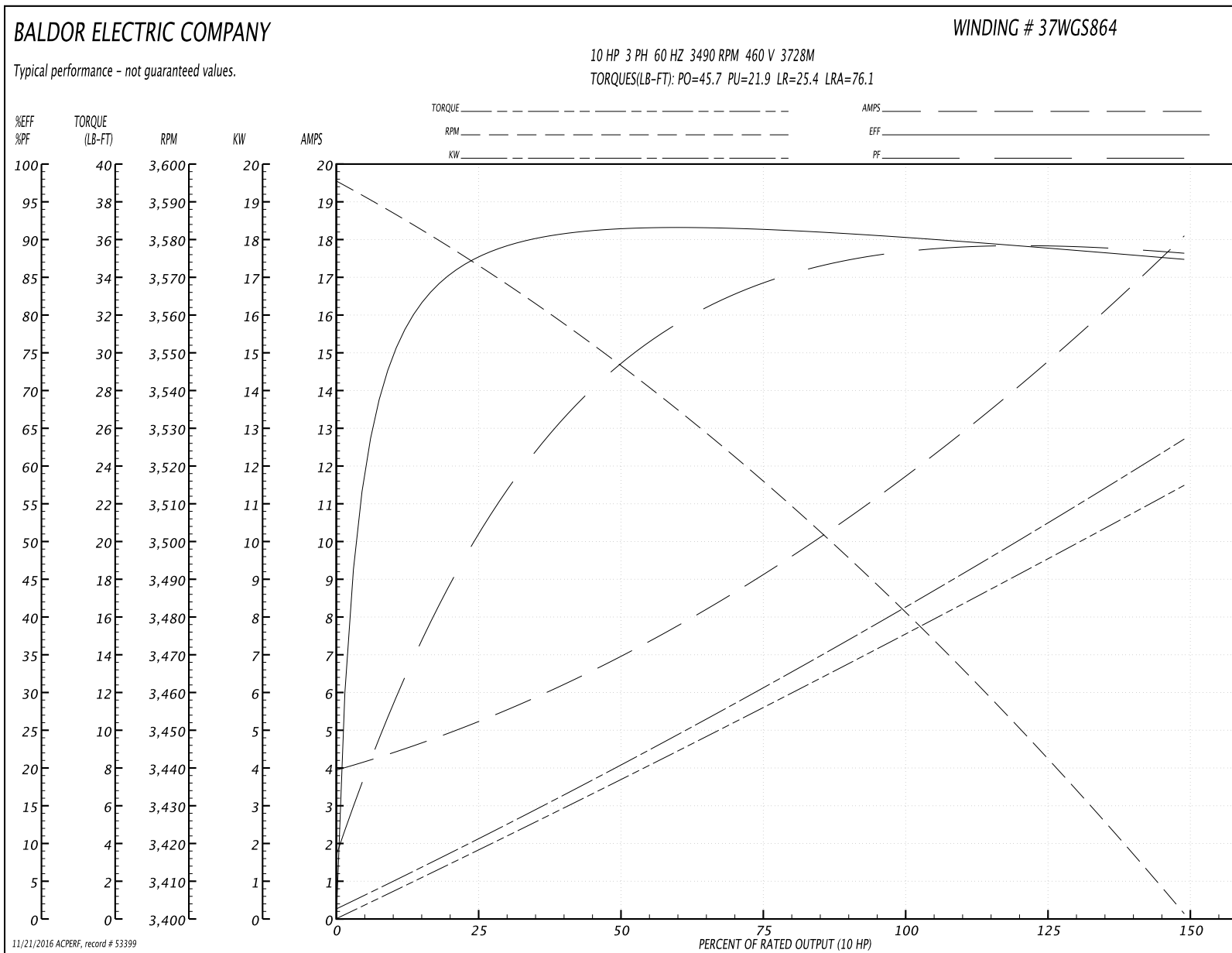

AC Induction Motor Performance Data

Record # 59174 - Typical performance - not guaranteed values

Winding: 37WGS864-R028	Type: 3728M	Enclosure: TEFC
-------------------------------	--------------------	------------------------

Nameplate Data				230 V, 60 Hz: Low Voltage Connection	
Rated Output (HP)	10			Full Load Torque	15 LB-FT
Volts	230/460			Start Configuration	direct on line
Full Load Amps	23.6/11.8			Breakdown Torque	45.7 LB-FT
R.P.M.	3490			Pull-up Torque	21.9 LB-FT
Hz	60	Phase	3	Locked-rotor Torque	25.4 LB-FT
NEMA Design Code	B	KVA Code	G	Starting Current	152 A
Service Factor (S.F.)	1.15			No-load Current	8.25 A
NEMA Nom. Eff.	90.2	Power Factor	87	Line-line Res. @ 25°C	0.248 Ω
Rating - Duty	40C AMB-CONT			Temp. Rise @ Rated Load	79°C
S.F. Amps				Temp. Rise @ S.F. Load	98°C
				Locked-rotor Power Factor	33.1
				Rotor inertia	0.255 LB-FT ²

Load Characteristics 230 V, 60 Hz, 10 HP

% of Rated Load	25	50	75	100	125	150	S.F.
Power Factor	53	74	84	87	88	89	88
Efficiency	86.7	91	91.4	90.6	89.1	87.3	90
Speed	3575	3547	3516	3482	3445	3401	3464
Line amperes	9.88	13.7	18.2	23.6	29.5	36	27.1

Performance Graph at 230V, 60Hz, 10.0HP Typical performance - Not guaranteed values

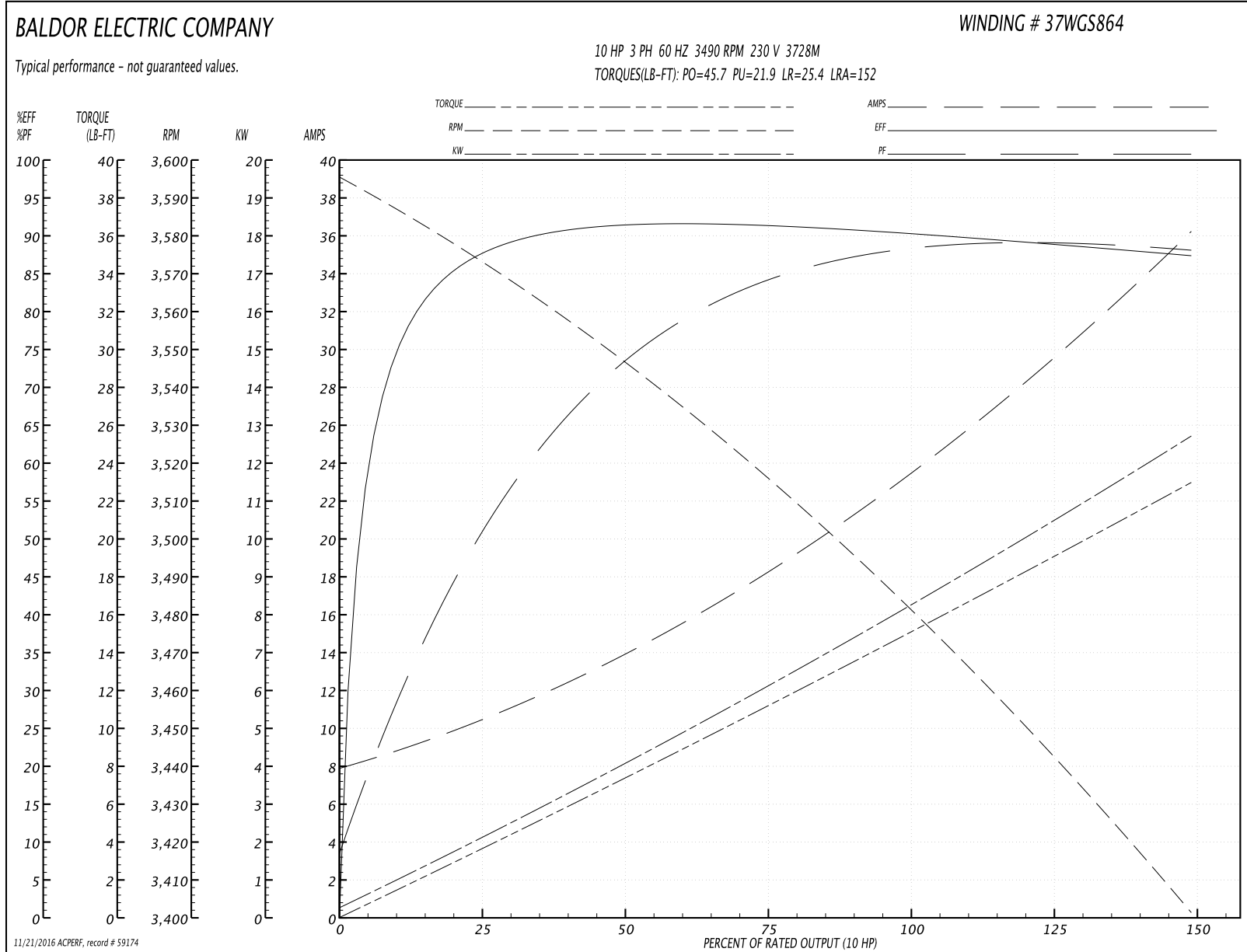

37LYH887

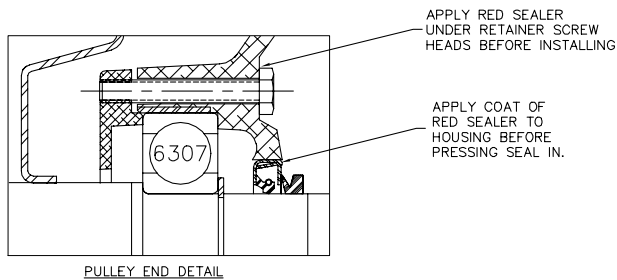
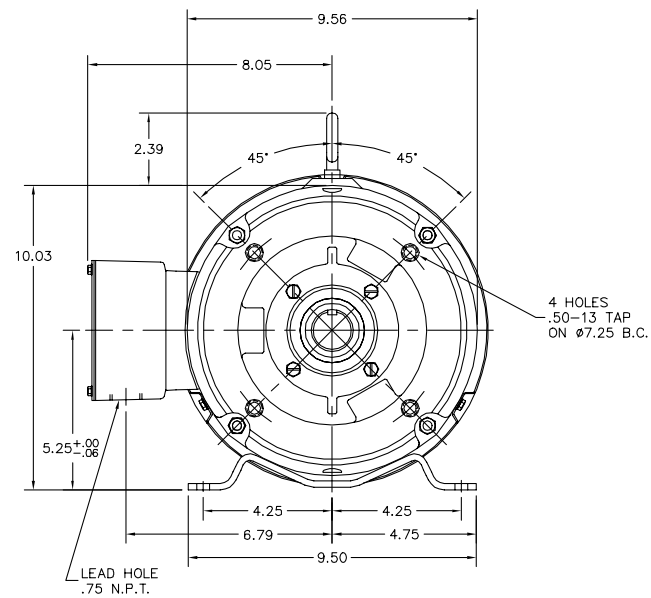
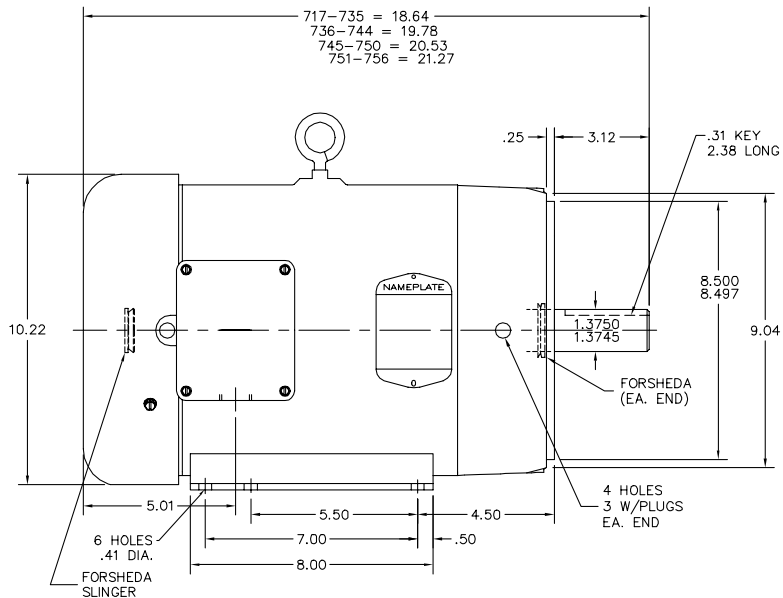

CUSTOMER IS RESPONSIBLE FOR DETERMINING THAT BALDOR'S PRODUCT WILL PERFORM SUITABLY IN THE INTENDED APPLICATION.

REV. DESC: REPLACE HA1005A02 WITH HW4600B74	VERSION: 02	TDR: 000000783785
REV. LTR: B	REVISD: 03:10:33 05/03/2013	BY: ENCARJ0
FILE: \AAA\00093\297		
MTL: -		

BALDOR
 STD HORZ 213-5TC TEFC 37M WD
 SH 1 of 1

37LYH887

CD0005

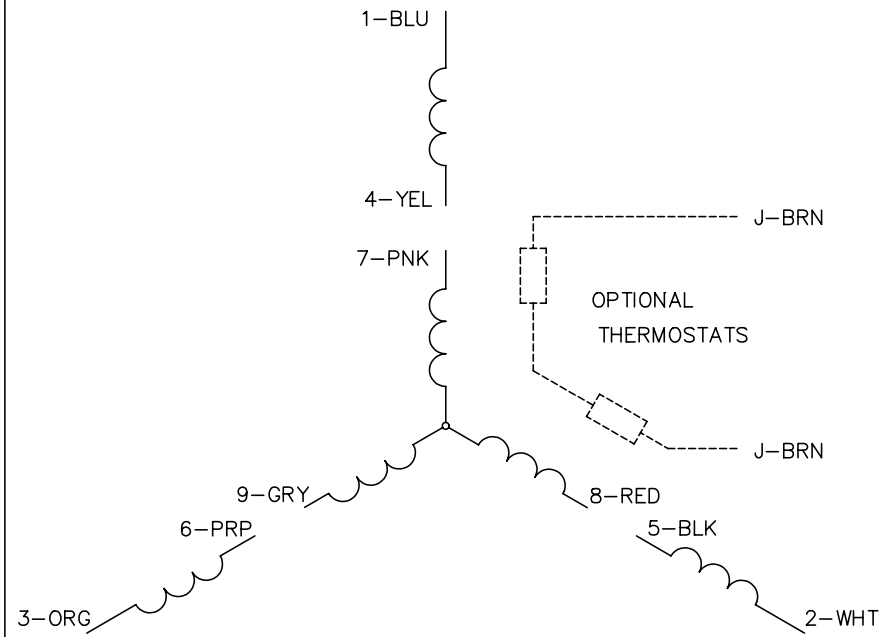

LOW VOLTAGE (2Y)

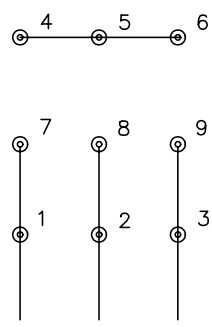

LINE

HIGH VOLTAGE (1Y)

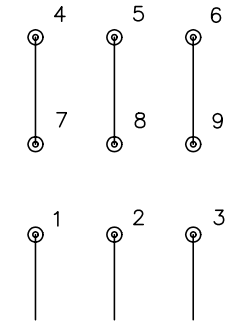

LINE

NOTES:

1. INTERCHANGE ANY TWO LINE LEADS TO REVERSE ROTATION.
2. OPTIONAL THERMOSTATS ARE PROVIDED WHEN SPECIFIED.
3. ACTUAL NUMBER OF INTERNAL PARALLEL CIRCUITS MAY BE A MULTIPLE OF THOSE SHOWN ABOVE.
4. LEAD COLORS ARE OPTIONAL. LEADS MUST ALWAYS BE NUMBERED AS SHOWN.

REV. DESC: REVISE TO SHOW OPTIONAL COLORS			
REV. LTR: E	BY: JLP	REVISED: 01/19/99 10:15	TDR: 0171435
9000D		FILE: AAA00005140	MDL: -
		MTL: -	

BALDOR ELECTRIC Co.

3PH, DV, 9 LEADS

CD0005