

SP SERIES PUMPS

SEALLESS SELF-PRIME

Performance Curves

FT06-935 R2

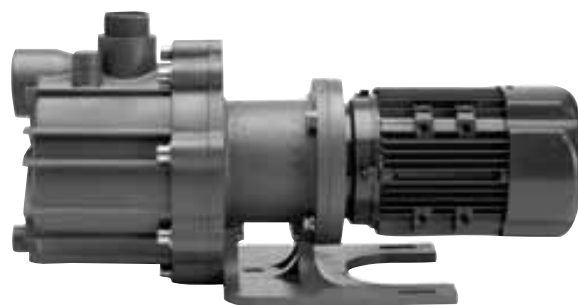

Table of Contents

SP Series Application Guidelines	4
SP10 Curves	
1" FNPT X 1" MNPT, 1" Suction Piping	
SP10 Priming Times - 3450 & 2900 rpm	5
3450 & 2900 rpm, Flooded Suction	6
3450 & 2900 rpm, 5 ft. (1.5 m) lift	7
3450 & 2900 rpm, 10 ft. (3 m) lift	8
3450 & 2900 rpm, 15 ft. (4.6 m) lift	9
1" FNPT X 1" MNPT, 1 1/2" Suction Piping	
SP10 Priming Times - 3450 & 2900 rpm	10
3450 & 2900 rpm, 5 ft. (1.5 m) lift	11
3450 & 2900 rpm, 10 ft. (3.0 m) lift	12
3450 & 2900 rpm, 15 ft. (4.6 m) lift	13
SP11 Curves	
SP11 & 15 Priming Times 3450 & 2900 rpm	14
3450 & 2900 rpm, flooded suction	15
3450 & 2900 rpm, 5 ft. (1.5 m) lift	16
3450 & 2900 rpm, 10 ft. (3 m) lift	17
3450 & 2900 rpm, 15 ft. (4.6 m) lift	18
SP15 Curves	
3450 & 2900 rpm, flooded suction	19
3450 & 2900 rpm, 5 ft. (1.5 m) lift	20
3450 & 2900 rpm, 10 ft. (3 m) lift	21
3450 & 2900 rpm, 15 ft. (4.6 m) lift	22
SP22 Curves	
SP22 2" Pipe Priming Times 3450 & 2900 rpm	23
SP22 3" Pipe Priming Times 3450 & 2900 rpm	24
SP22 3450 & 2900 Flooded suction	25
2" Suction & 2" Discharge Pipe	
3450 & 2900 rpm, 5 ft. (1.5 m) lift	26
3450 & 2900 rpm, 10 ft. (3 m) lift	27
3450 & 2900 rpm, 15 ft. (4.6 m) lift	28
3" Suction & 2" Discharge Pipe	
3450 & 2900 rpm, 5 ft. (1.5 m) lift	29
3450 & 2900 rpm, 10 ft. (3 m) lift	30
3450 & 2900 rpm, 15 ft. (4.6 m) lift	31

Note: For performance curves of lifts between 15 and 25 feet, please contact the factory.

Contact Information:
 Finish Thompson Inc.
 921 Greengarden Rd.
 Erie, PA 16501-1591 USA

Ph	1-814-455-4478
Toll Free	1-800-934-9384 (USA & Canada only)
Fax	1-814-455-8518
Order Fax	1-814-459-3460
Email	sales@finishthompson.com
Tech Service	1-800-888-3743

SP Series Application Guidelines

SP Series pumps are applied similar to other Finish Thompson mag drive centrifugal pumps, but there are a few special considerations.

Equivalent Lift

Performance varies with the amount of lift. This calculation allows you to determine which SP performance curve you should use based upon the height of the application's lift.

SP Series pumps are capable of lifting fluid from as deep as 25 feet (7.6 meters) below the pump depending upon the model and impeller diameter. However, factors such as pipe friction loss, specific gravity and altitude can decrease a pump's maximum lift capability. Adjustments must be calculated to ensure that both the proper performance curves are being used and that the lift required is within the pump's maximum lift capability.

If corrections are required for both altitude and specific gravity, first make the adjustment for altitude; then make the adjustment for specific gravity on altitude-adjusted value.

- Altitude – Maximum suction lift capability is reduced by 1.13 feet (.34 meters) for every 1,000 feet (304 meters) of altitude. For example, if the pump is going to be installed at an altitude of 5,000 feet (1.5 kilometers), then the maximum lift is reduced by 5.65 feet (1.7 meters).
- Specific gravity – Divide the model's maximum lift capability by the specific gravity of the fluid. For example, if you are pumping a fluid with a specific gravity of 1.84, and the maximum lift on water is 25 feet (7.6 meters), then the adjusted maximum lift is 13.6 feet (4.1 meters).

Suction Pipe Size

Hydraulic performance is enhanced in lift applications using SP10 and SP22 models with a larger suction pipe. Curves have been prepared showing performance for the SP10 with 1" and 1 1/2" and the SP22 with 2" and 3" suction pipes at various lifts. Note the priming time increases as suction pipe diameter increases. Refer to the prime time charts section for the SP10 and SP22 before selecting a final suction pipe diameter.

Use flooded suction curves when the pump is installed below the liquid level. When a pump is positioned below the liquid level, the pump should be considered to be operating with a flooded suction (See figure 1). In those cases, use the SP flooded suction published performance curves.

If you have any questions, please contact FTI sales. We are here to help!

Temperature Rise During Priming

The priming liquid in the housing will rise approximately 3° F (1.6° C) per minute while the pump is priming. This information is based on cold water testing at FTI.



Figure 1



**SP10 Prime Time- 3450 RPM
1" Suction Pipe**

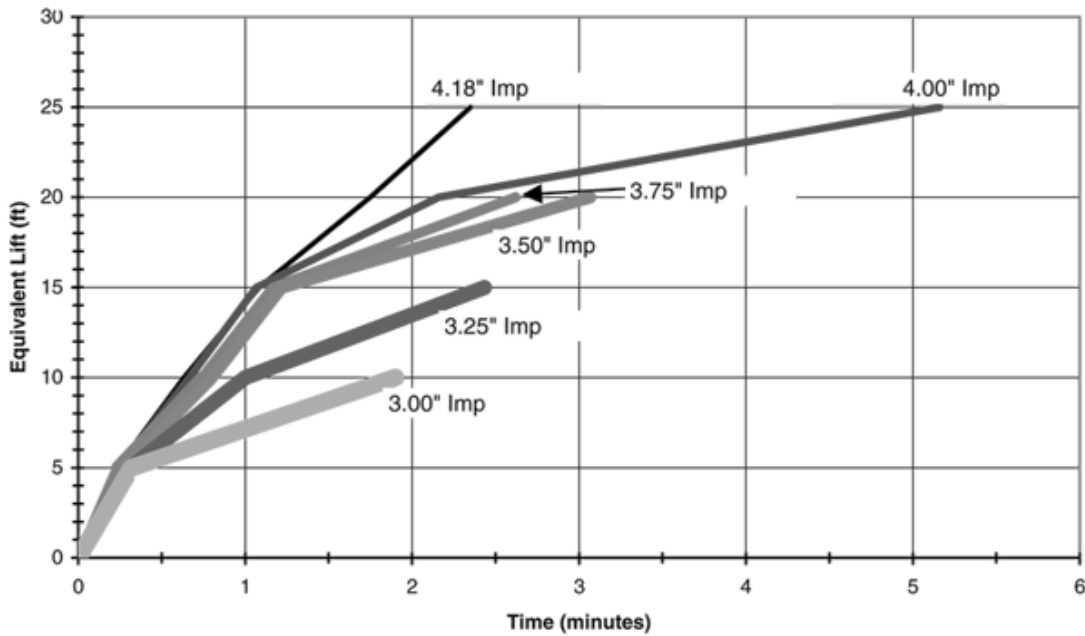

**SP10 Prime Times- 2900 RPM
1" Suction Pipe**

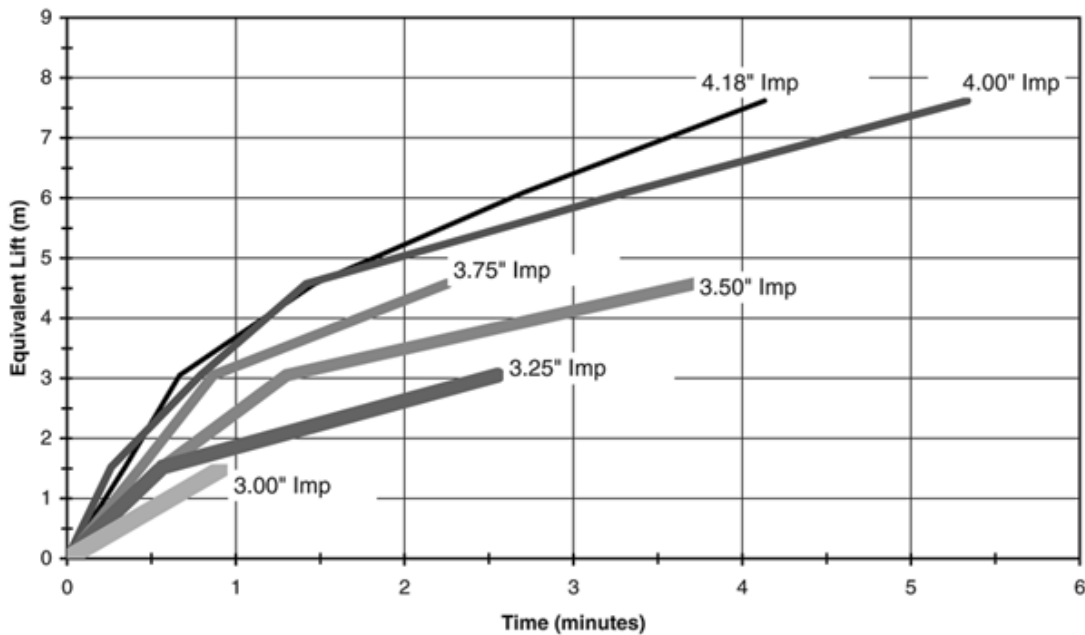

Note: Times shown are guidelines only, and may vary depending on system and piping setup
Maximum equivalent lift varies depending upon impeller size

Temperature Rise During Priming

The priming liquid in the housing will rise approximately 3° F (1.6° C) per minute while the pump is priming. This information is based on cold water testing at FTI.



PERFORMANCE WITH 1" OR 1-1/2" SUCTION PIPING

SP10, 3450 RPM, 60 Hz, Flooded Suction

Suction: 1" FNPT; Discharge: 1" MNPT

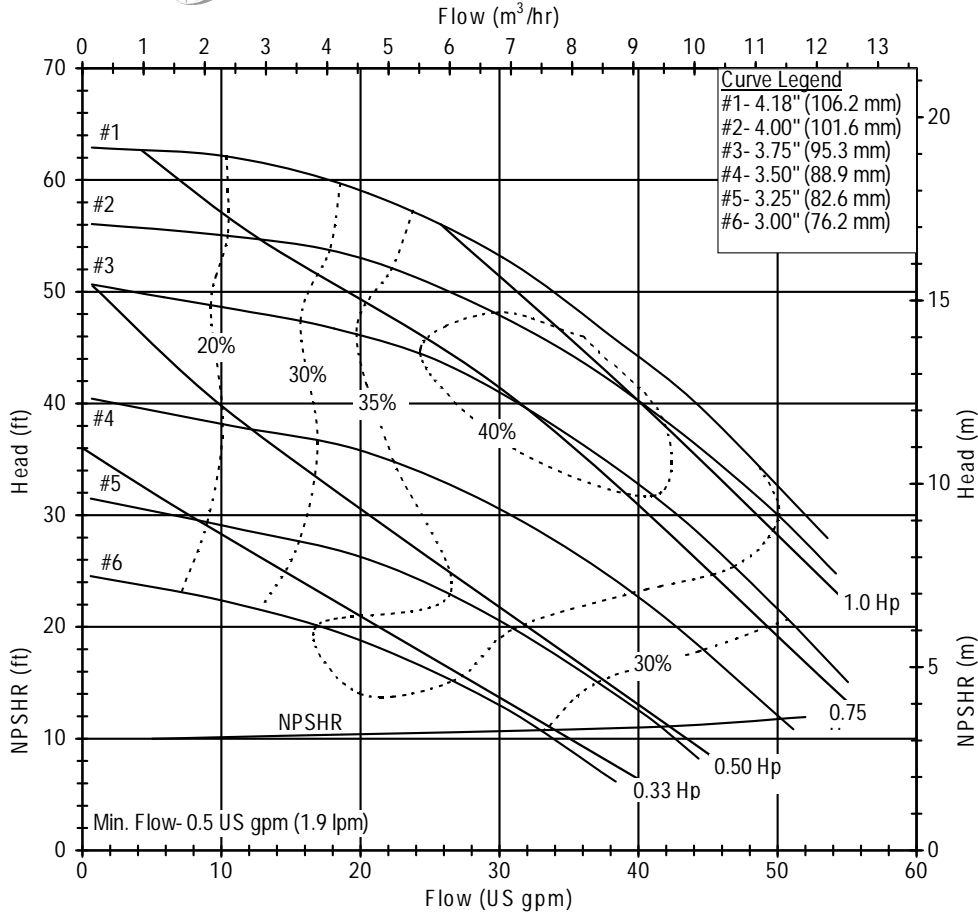

Maximum Lift 3450 rpm, 1.0 sg		
Imp Curve	1-inch Suction Pipe	1-1/2-inch Suction Pipe
#1	25' (7.6 m)	25' (7.6 m)
#2	25' (7.6 m)	25' (7.6 m)
#3	20' (6.1 m)	20' (6.1 m)
#4	20' (6.1 m)	15' (4.6 m)
#5	15' (4.6 m)	15' (4.6 m)
#6	10' (3.0 m)	10' (3.0 m)

SP10, 2900 RPM, 50 Hz, Flooded Suction

Suction: 1" FNPT; Discharge: 1" MNPT

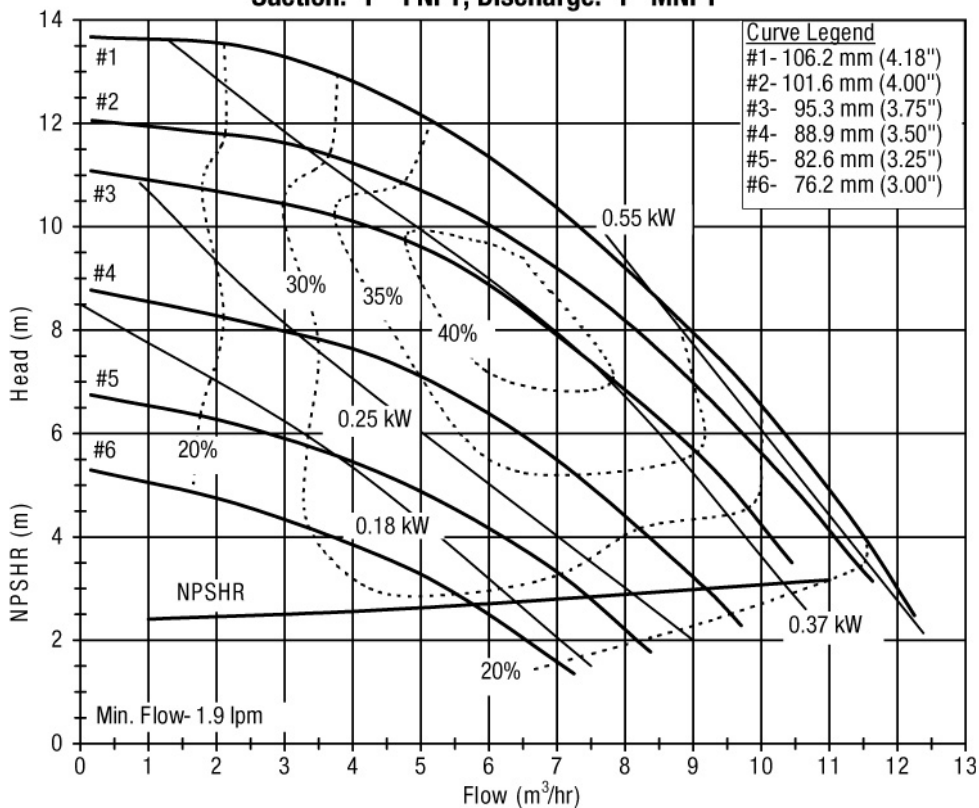

Maximum Lift 2900 rpm, 1.0 SG		
Imp Curve	1-inch Suction Pipe	1-1/2-inch Suction Pipe
#1	7.6 m	7.6 m
#2	7.6 m	6.1 m
#3	6.1 m	4.6 m
#4	4.6 m	3.0 m
#5	3.0 m	3.0 m
#6	1.5 m	1.5 m



PERFORMANCE WITH 1" SUCTION PIPING

SP10, 3450 RPM, 60 HZ, 5 ft. (1.5 m) Equivalent Lift

Suction: 1" FNPT; Discharge: 1" MNPT

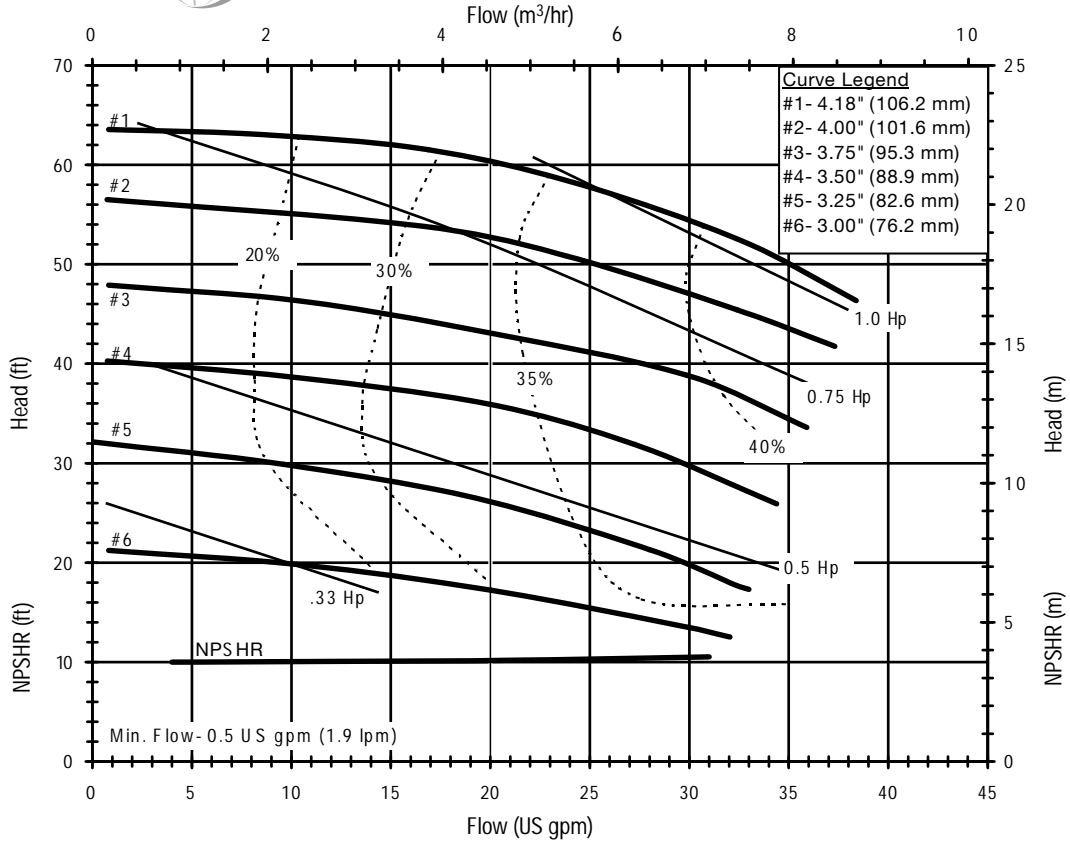

SP10, 2900 RPM, 50-Hz, 1.5 m, Equivalent Lift

Suction: 1" FNPT; Discharge: 1" MNPT

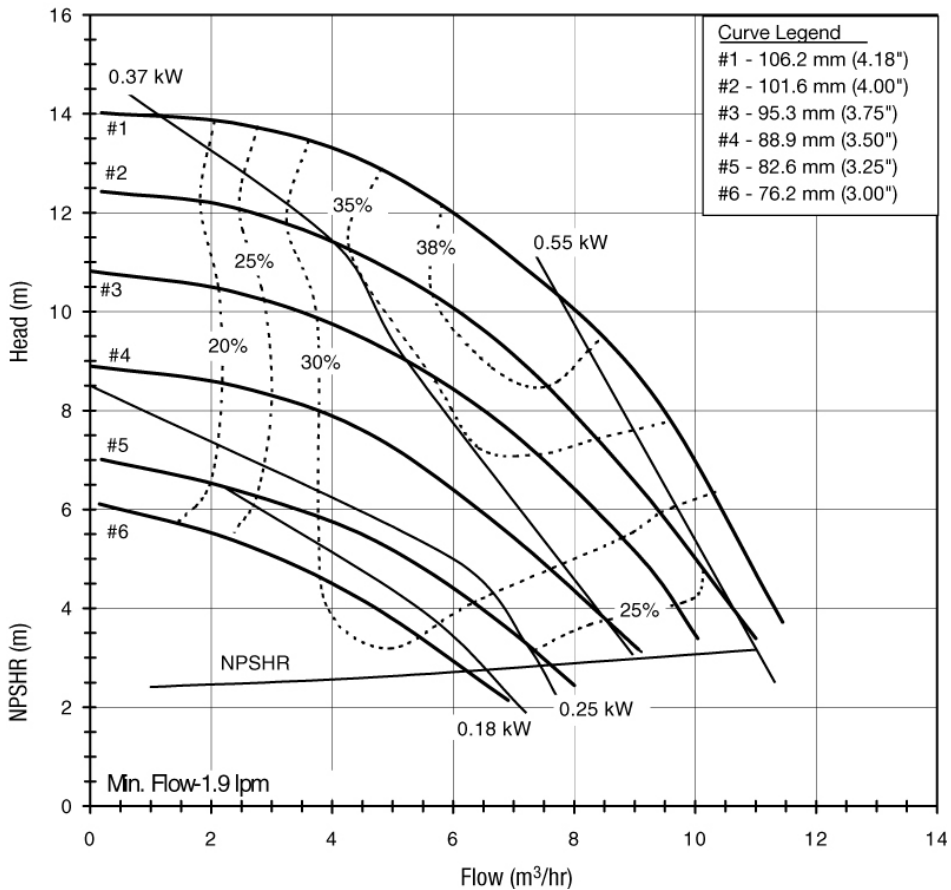



PERFORMANCE WITH 1" SUCTION PIPING

SP10, 3450 RPM, 60 HZ, 10 ft. (3.0 m) Equivalent Lift

Suction: 1" FNPT; Discharge: 1" MNPT

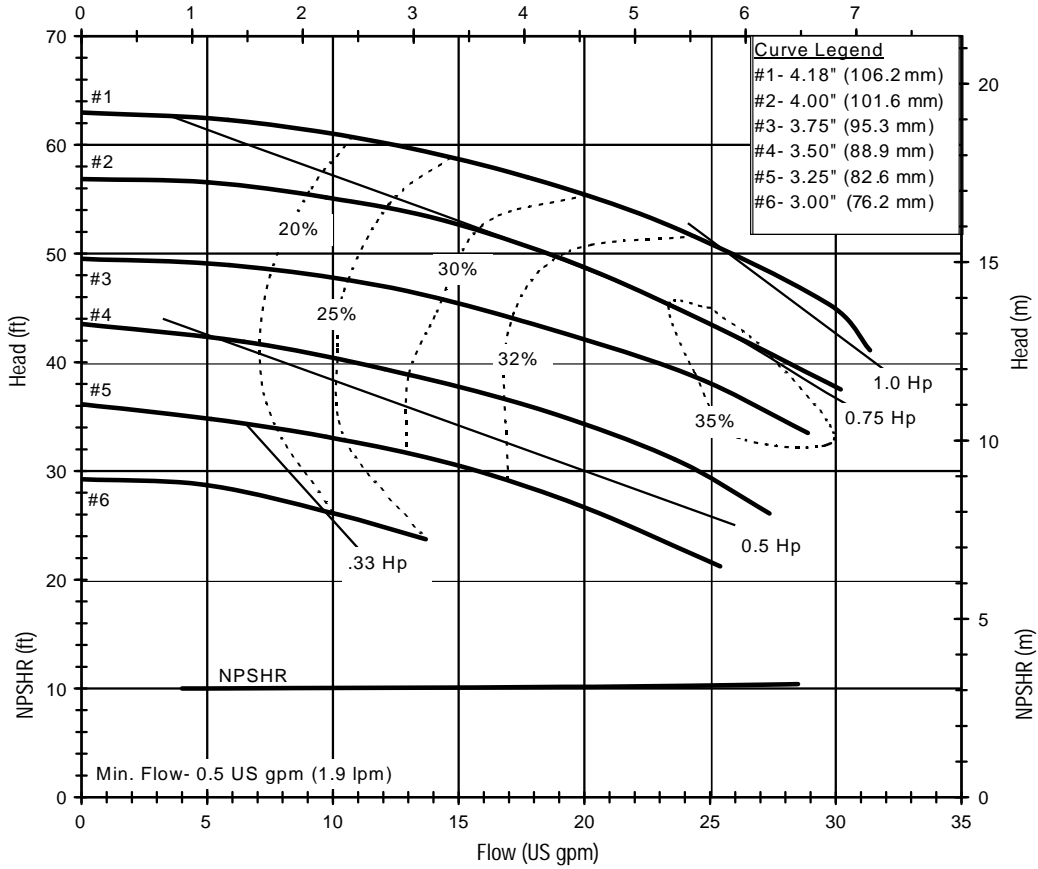

SP10, 2900 rpm, 50 Hz, 3.0 m (10 ft.) Equivalent Lift

Suction: 1" FNPT; Discharge: 1" MNPT

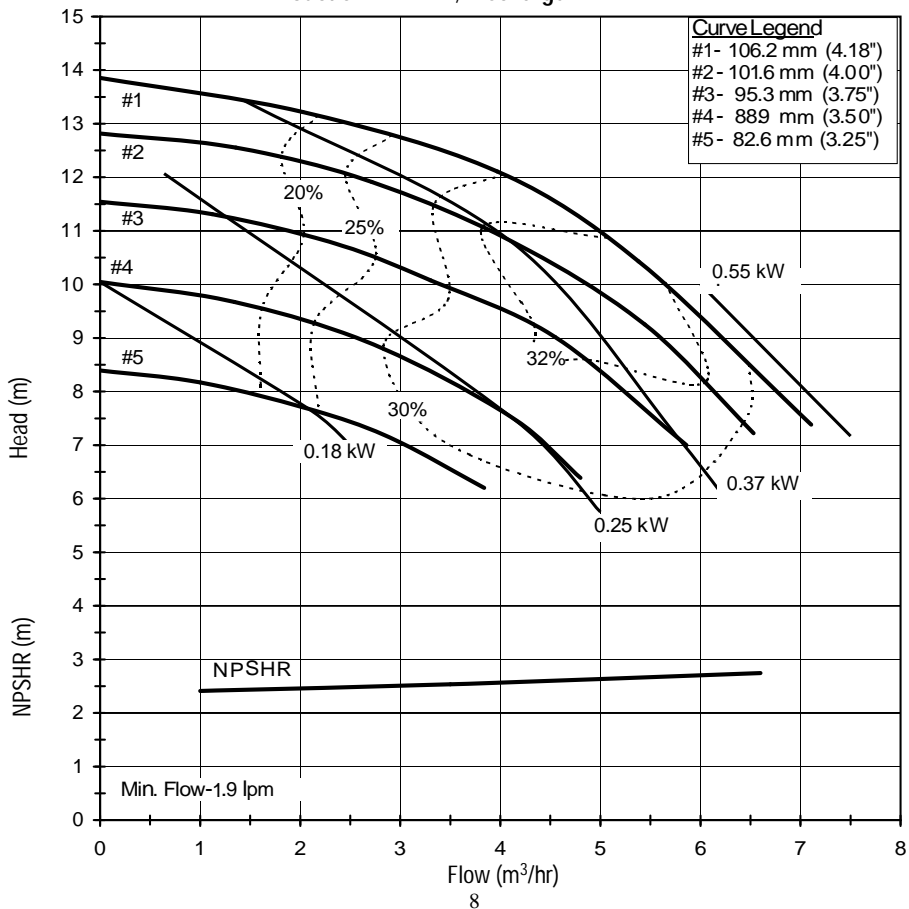



PERFORMANCE WITH 1" SUCTION PIPING

SP10, 3450 RPM, 60 Hz, 15 ft. (4.6 m) Equivalent Lift

Suction: 1" FNPT; Discharge: 1" MNPT

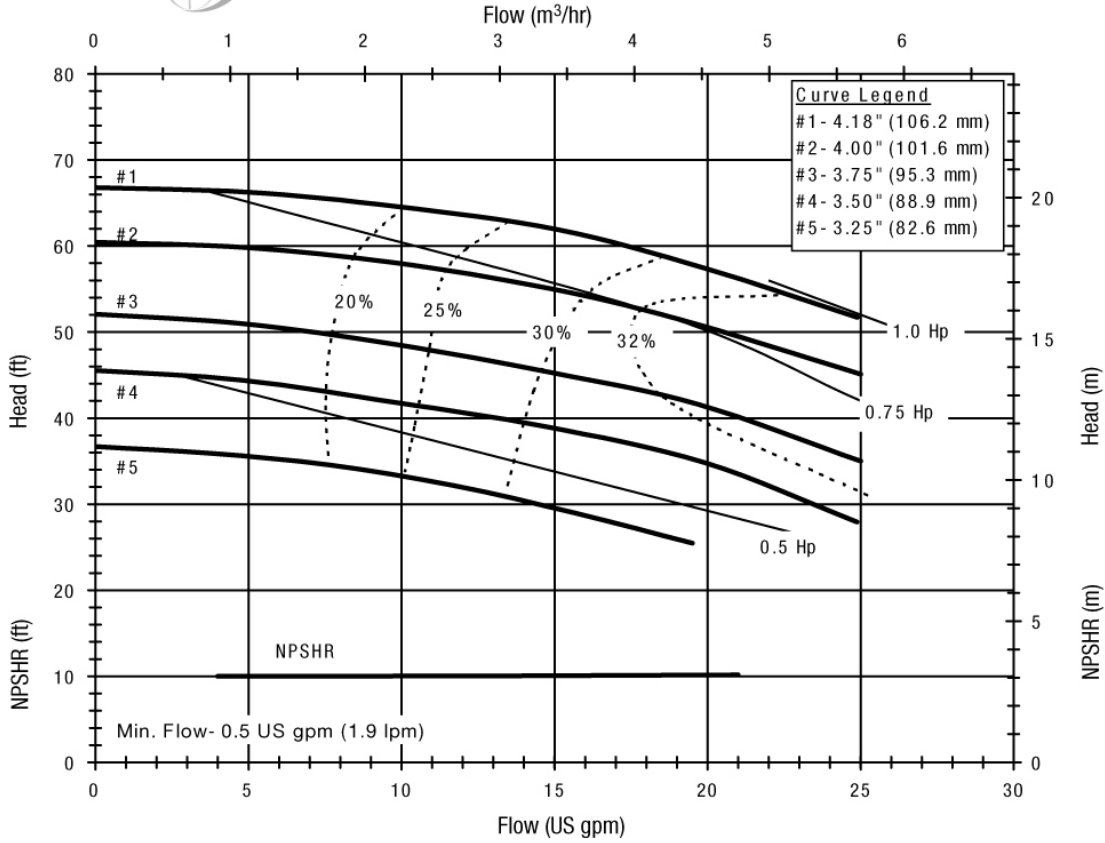

SP10, 2900 rpm, 50 Hz, 4.6 m (15 ft.) Equivalent Lift

Suction: 1" FNPT; Discharge: 1" MNPT

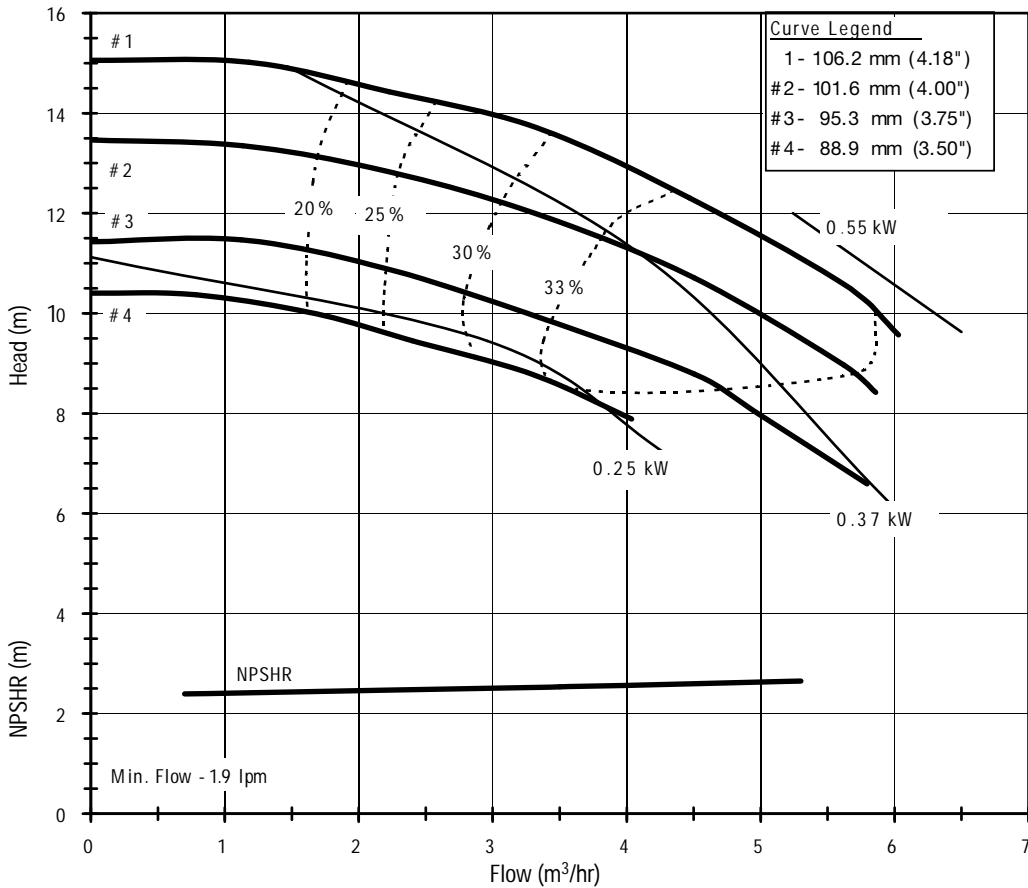



SP10 Prime Times- 3450 RPM
1-1/2" Suction Pipe

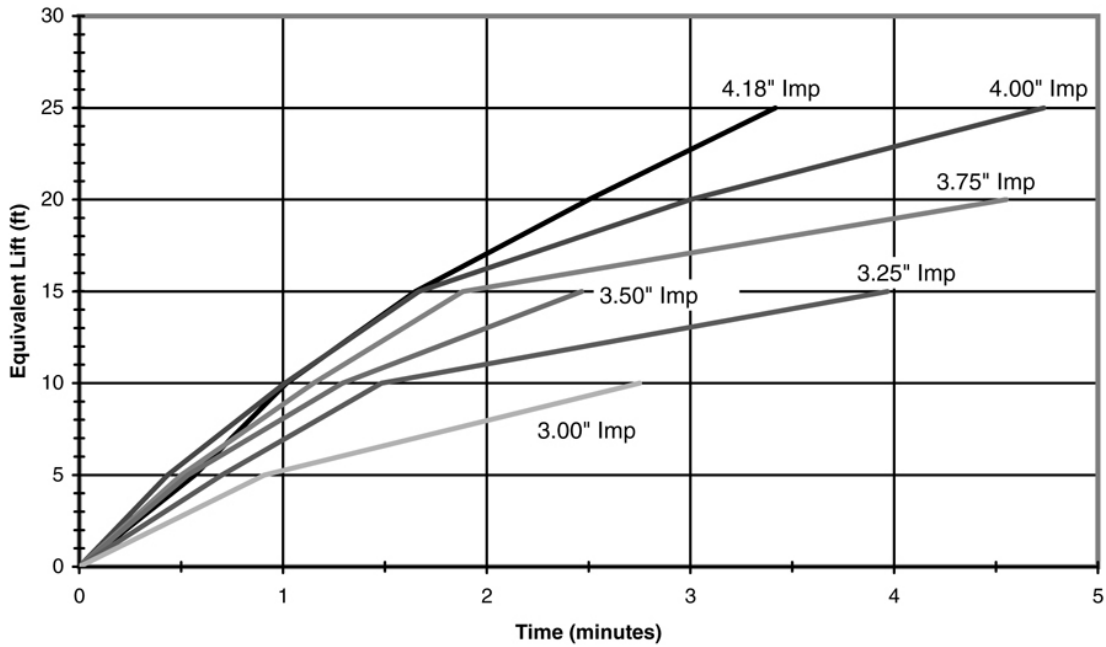

SP10 Prime Times- 2900 RPM
1-1/2" Suction Pipe

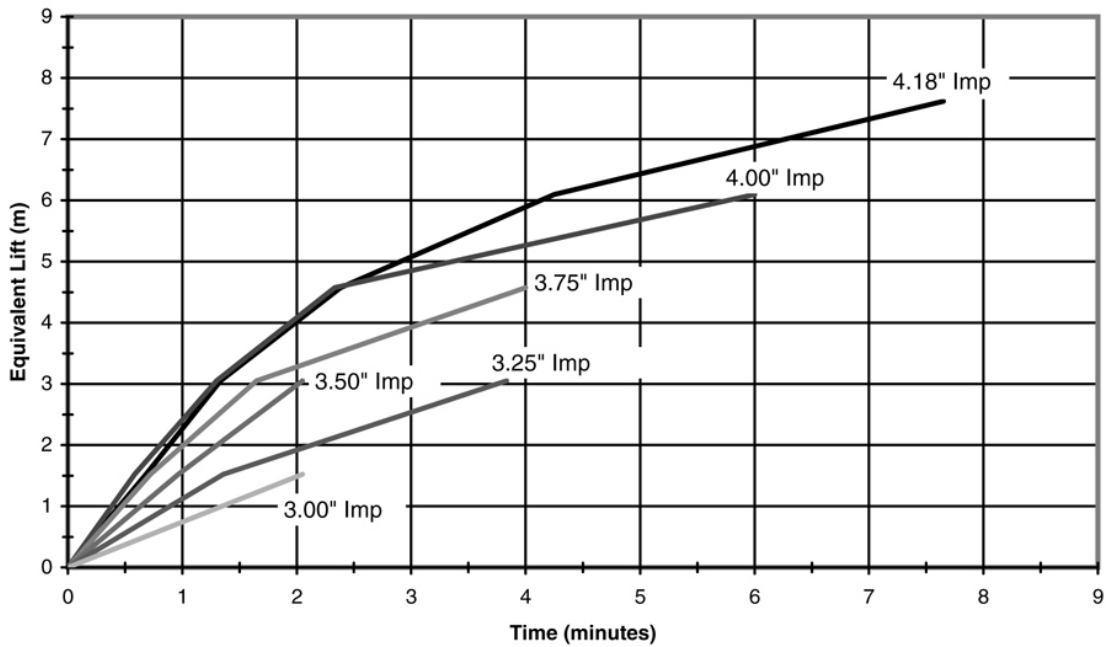

Note: For faster priming or additional equivalent lift, contact the factory for assistance.
Times shown are guidelines only and may vary depending upon system and piping setup.
Maximum equivalent lift varies depending upon impeller size.

GUIDELINES:

Temperature Rise During Priming

The priming liquid in the housing will rise approximately 3° F (1.6° C) per minute while the pump is priming. This information is based on cold water testing at FTI.



PERFORMANCE WITH 1-1/2" SUCTION PIPING

SP10, 3450 RPM, 60-Hz, 5 ft. (1.5 m) Equivalent Lift

Suction: 1" FNPT; Discharge: 1" MNPT

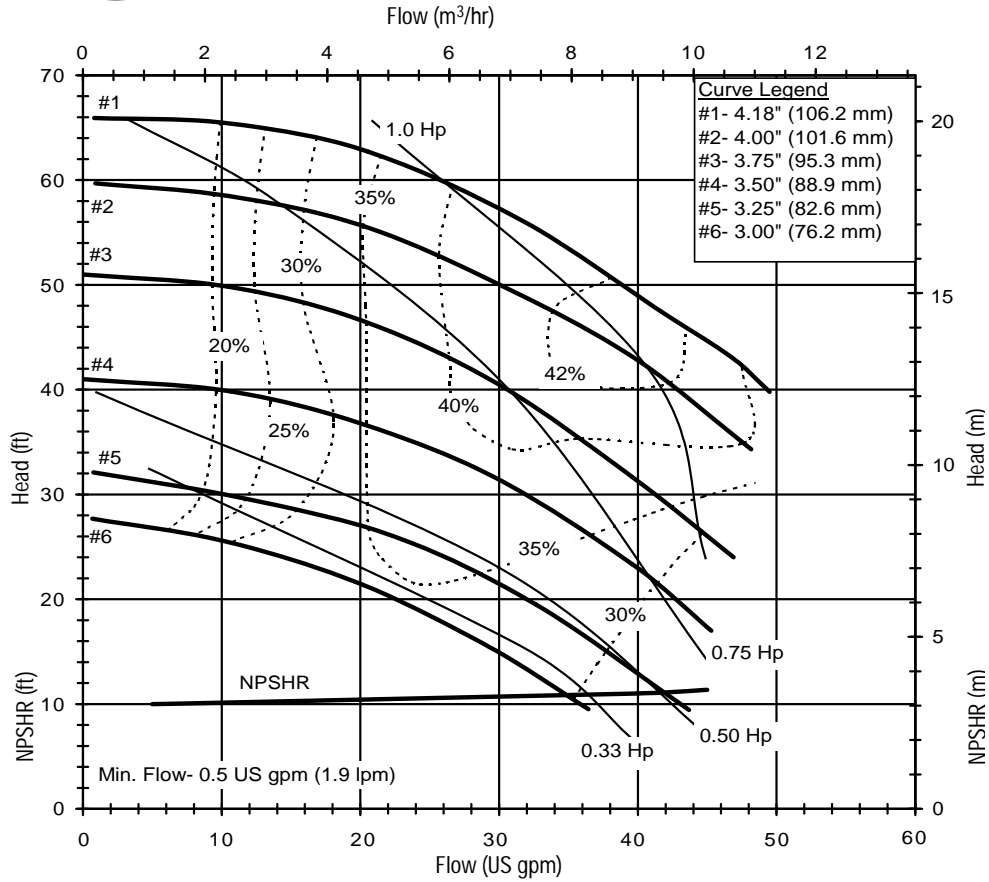

SP10, 2900 RPM, 50 Hz, 1.5 m (5 ft.) Equivalent Lift

Suction: 1" FNPT; Discharge: 1" MNPT

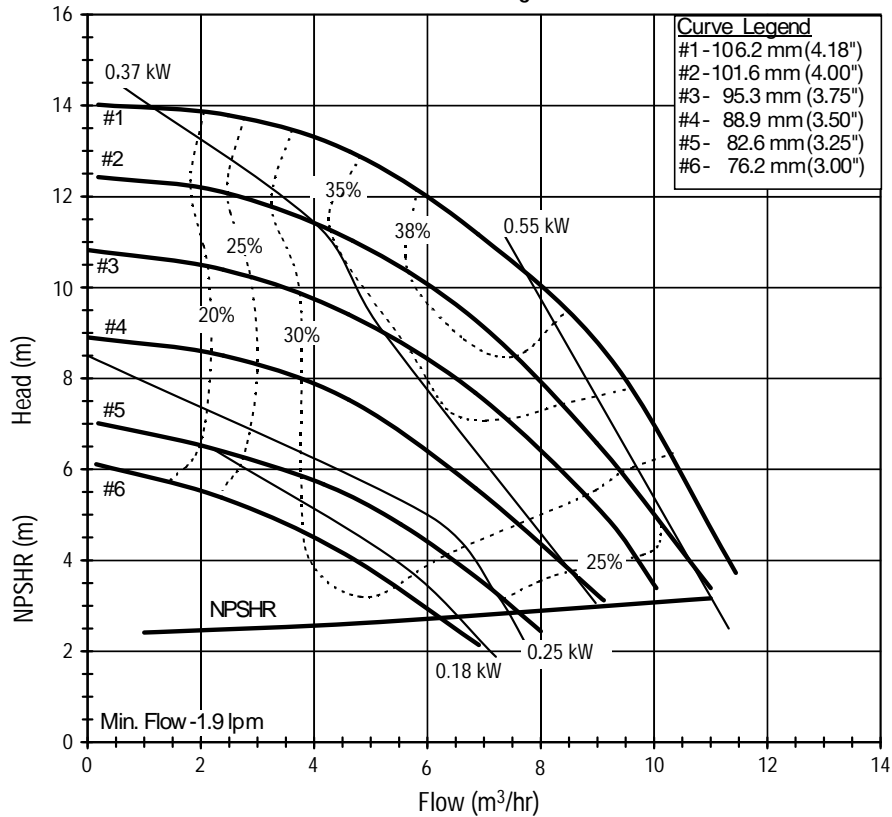



PERFORMANCE WITH 1-1/2" SUCTION PIPING

SP10, 3450 RPM, 60 HZ, 10 ft. (3.0 m) Equivalent Lift

Suction: 1" FNPT; Discharge: 1" MNPT

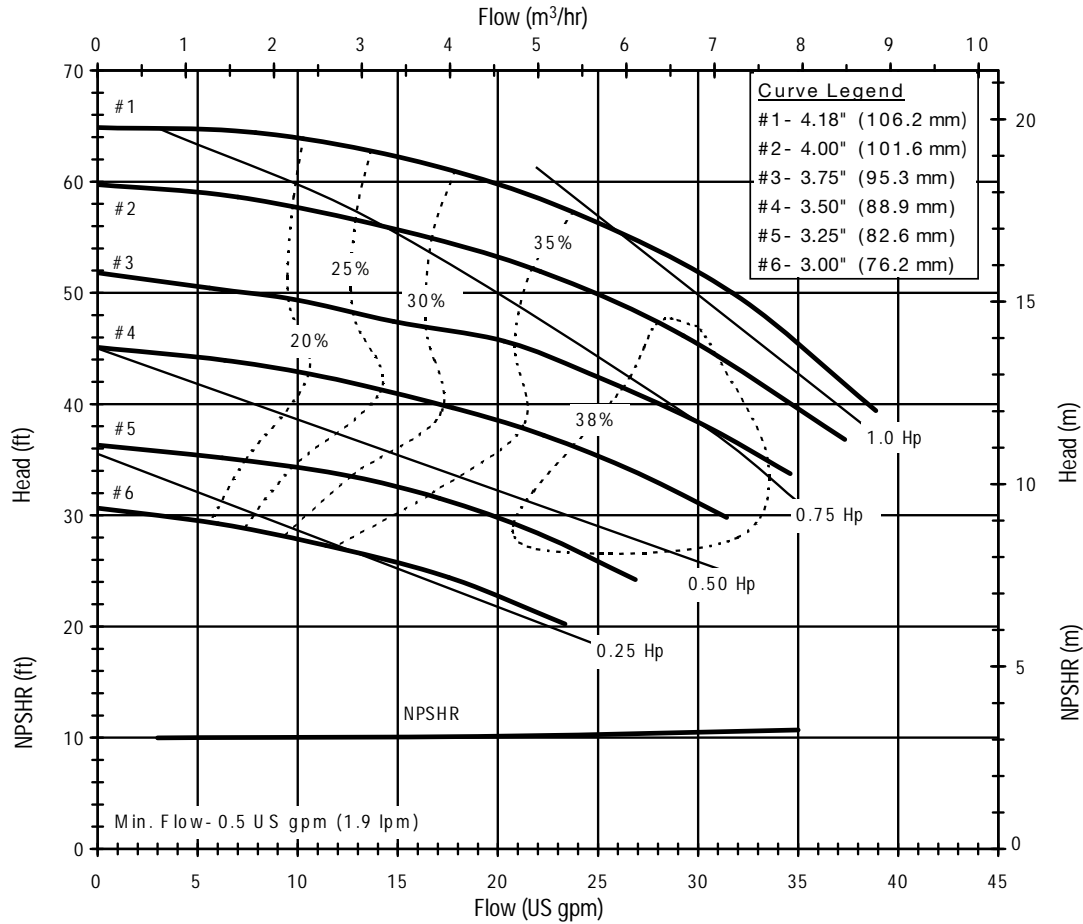

SP10, 2900 RPM, 50 HZ, 3.0 m (10 ft.) Equivalent Lift

Suction: 1" FNPT; Discharge: 1" MNPT

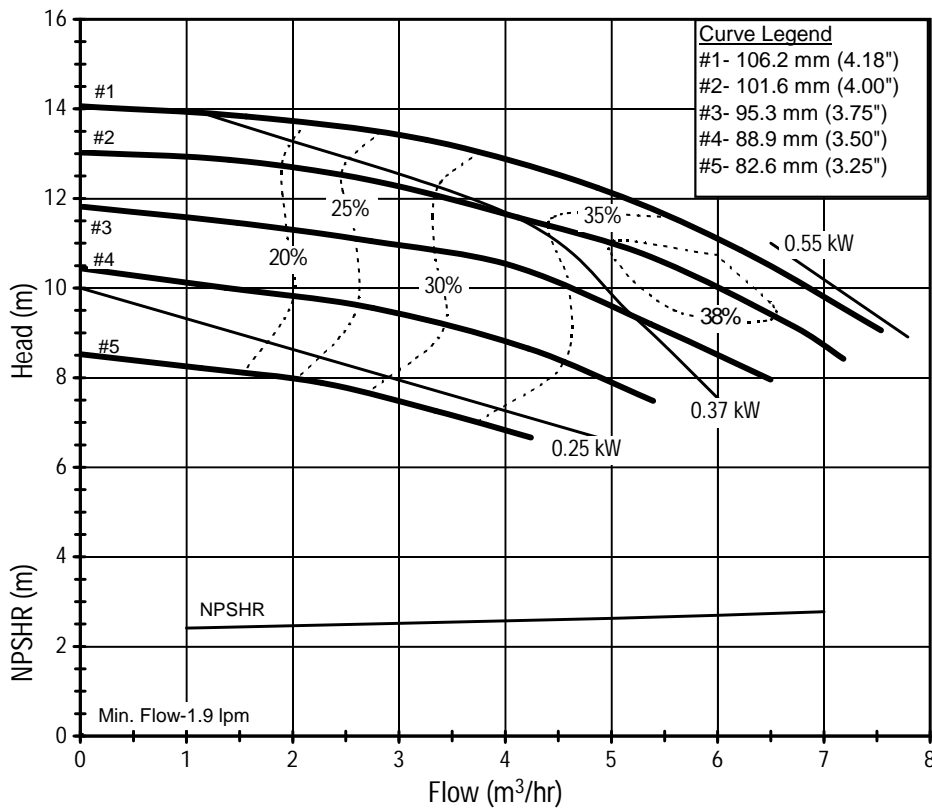



PERFORMANCE WITH 1-1/2" SUCTION PIPING

SP10, 3450 RPM, 60 Hz, 15 ft. (4.6 m) Equivalent Lift

Suction: 1" FNPT; Discharge: 1" MNPT

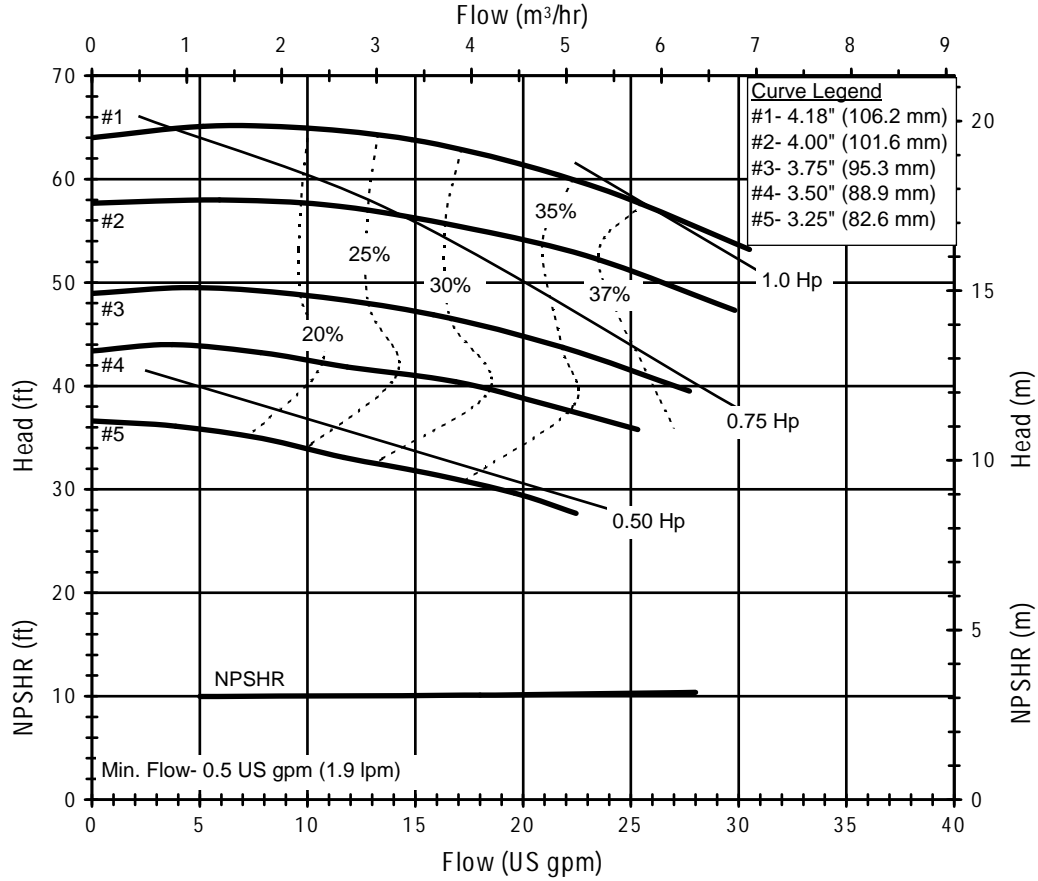

SP10, 2900 RPM, 50 HZ, 4.6 m (15 ft.) Equivalent Lift

Suction: 1" FNPT; Discharge: 1" MNPT

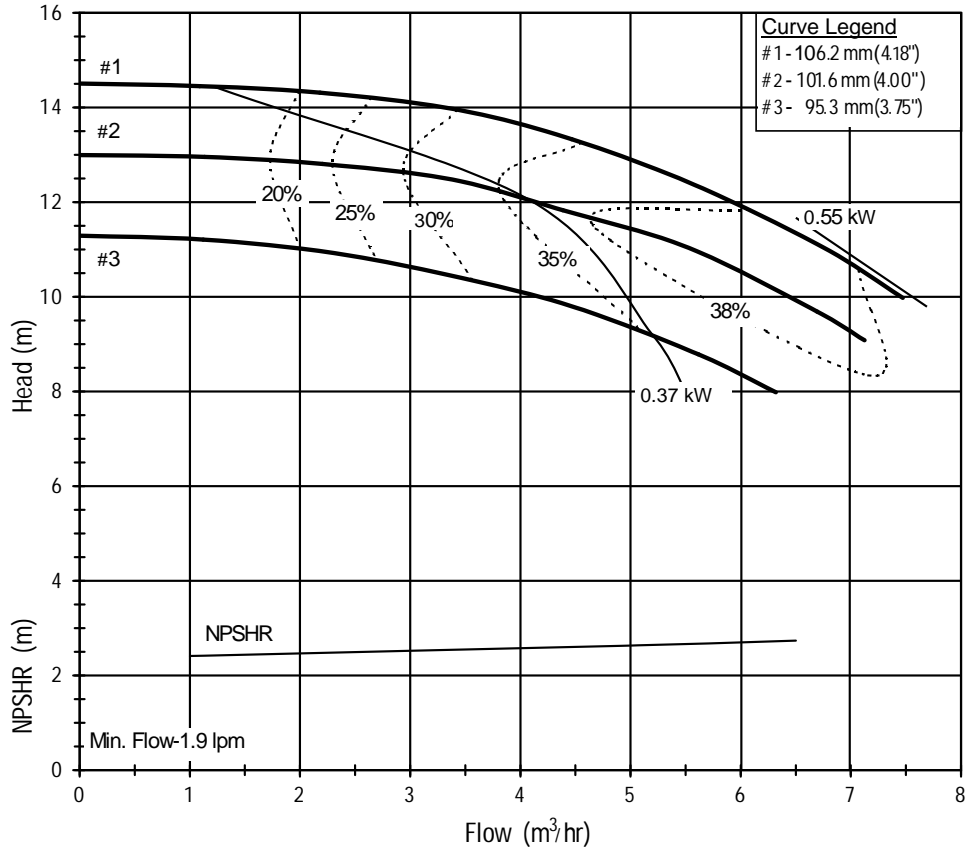



SP11/15 Priming Times 3150 RPM; 60-Hz

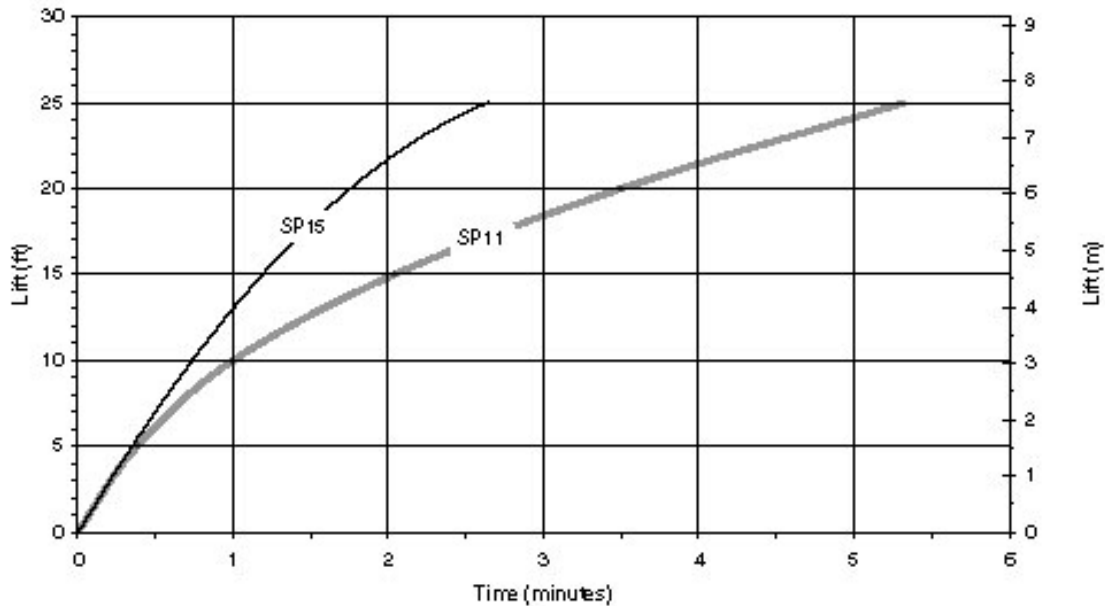

SP11/15 Priming Times 2900 RPM; 50-Hz

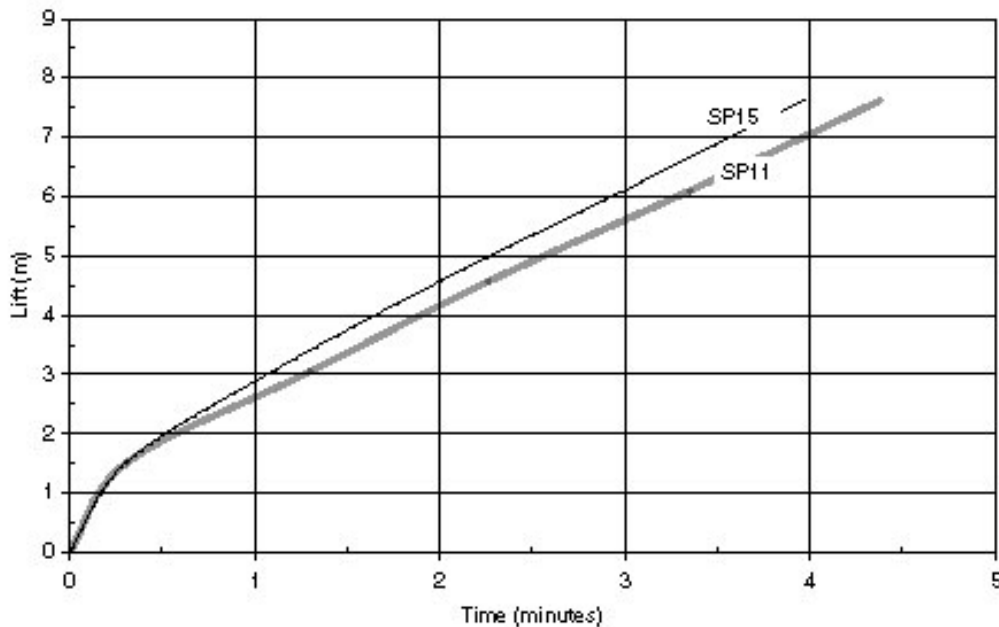

Note: Times shown are guidelines only and may vary depending on system and piping setup.
Note: Values shown are with maximum diameter impeller.

GUIDELINES:

Temperature Rise During Priming

The priming liquid in the housing will rise approximately 3° F (1.6° C) per minute while the pump is priming. This information is based on cold water testing at FTI.



SP11 Performance Curves- Flooded Suction- 60-Hz 3450 RPM
Suction: 1-1/2" FNPT Discharge:1-1/2" MNPT

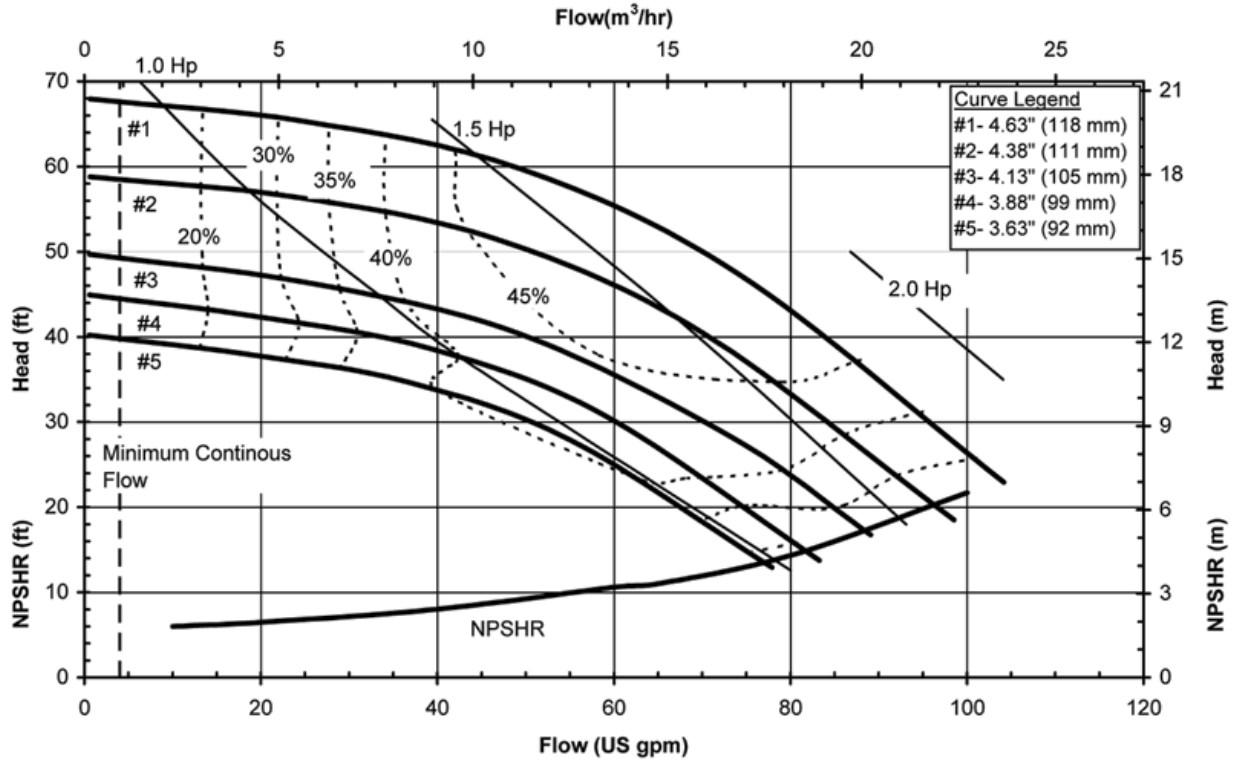

SP11 Performance Curves- Flooded Suction- 50-Hz 2900 RPM
Suction: 1-1/2" FNPT Discharge:1-1/2" MNPT

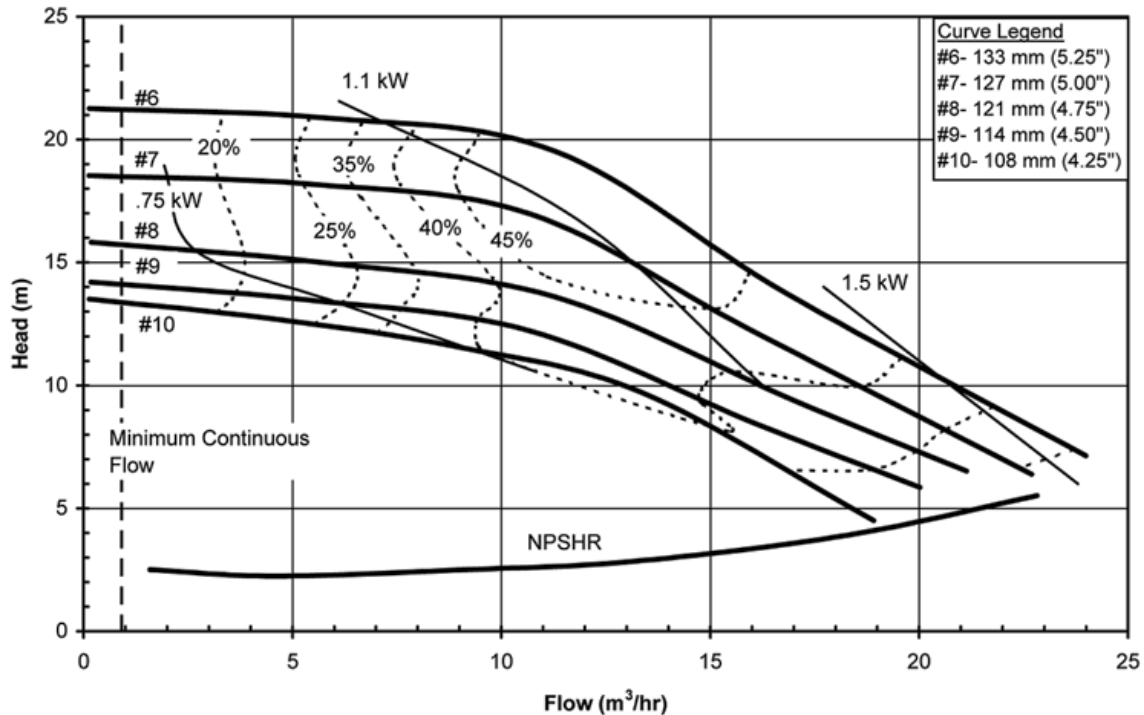



SP11, 3450 RPM, 60-Hz, 5 ft. (1.5 m) Lift
Suction: 1-1/2" FNPT; Discharge: 1-1/2" MNPT

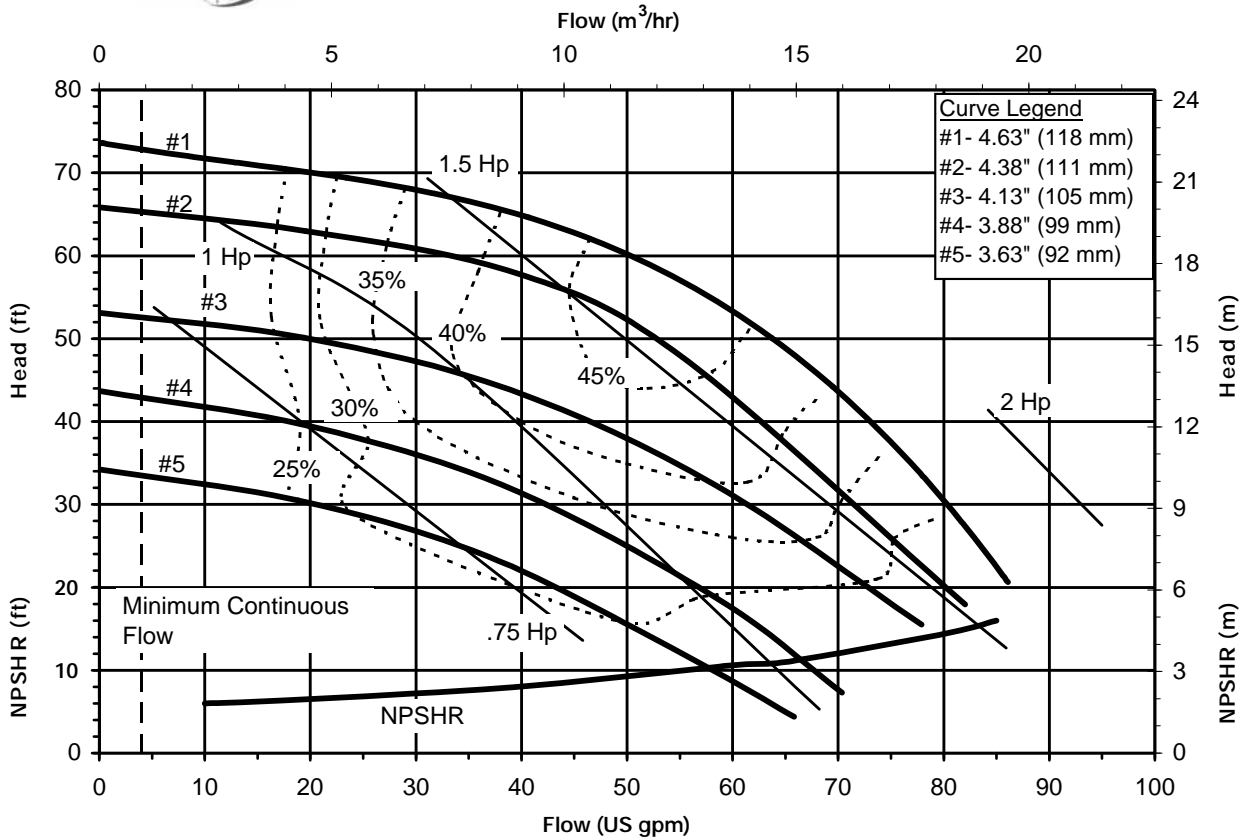

SP11; 2900 RPM, 50-Hz, 1.5 m (5 ft.) Lift
Suction: 1-1/2" FNPT; Discharge: 1-1/2" MNPT

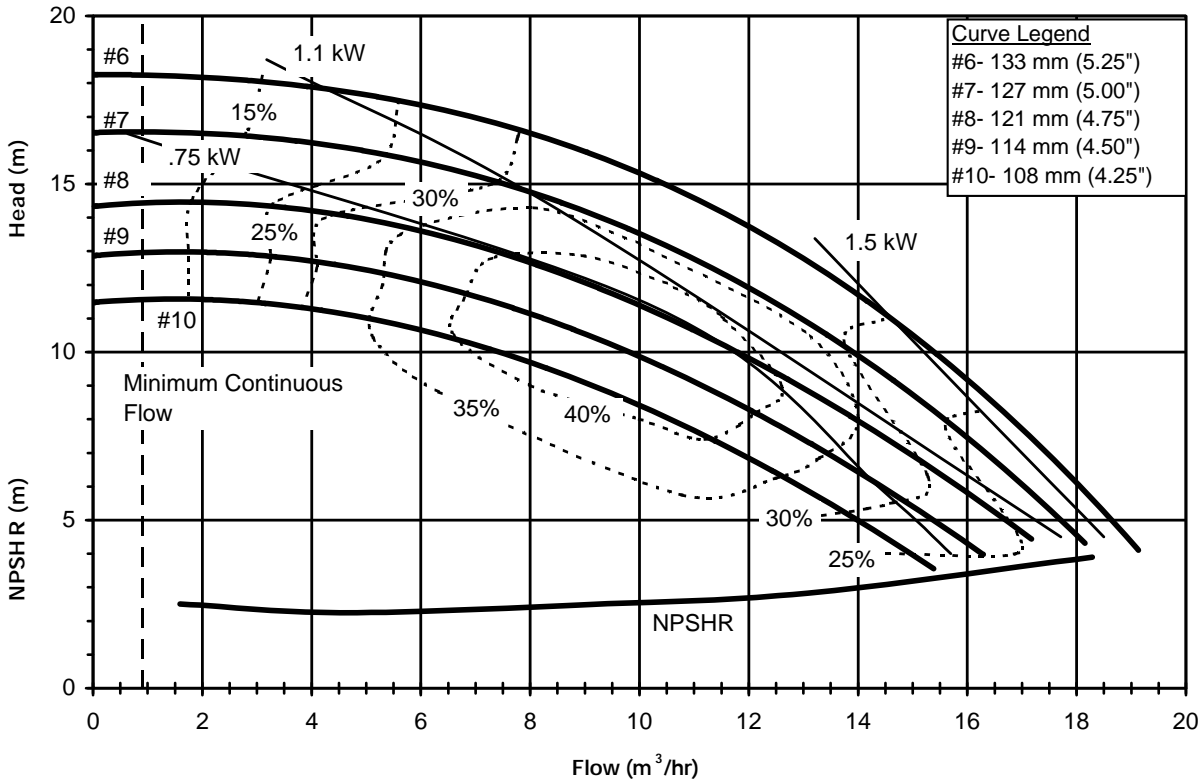



SP11, 3450 RPM, 60-Hz, 10 ft. (3.0 m) Lift
Suction: 1-1/2" FNPT; Discharge: 1-1/2" MNPT

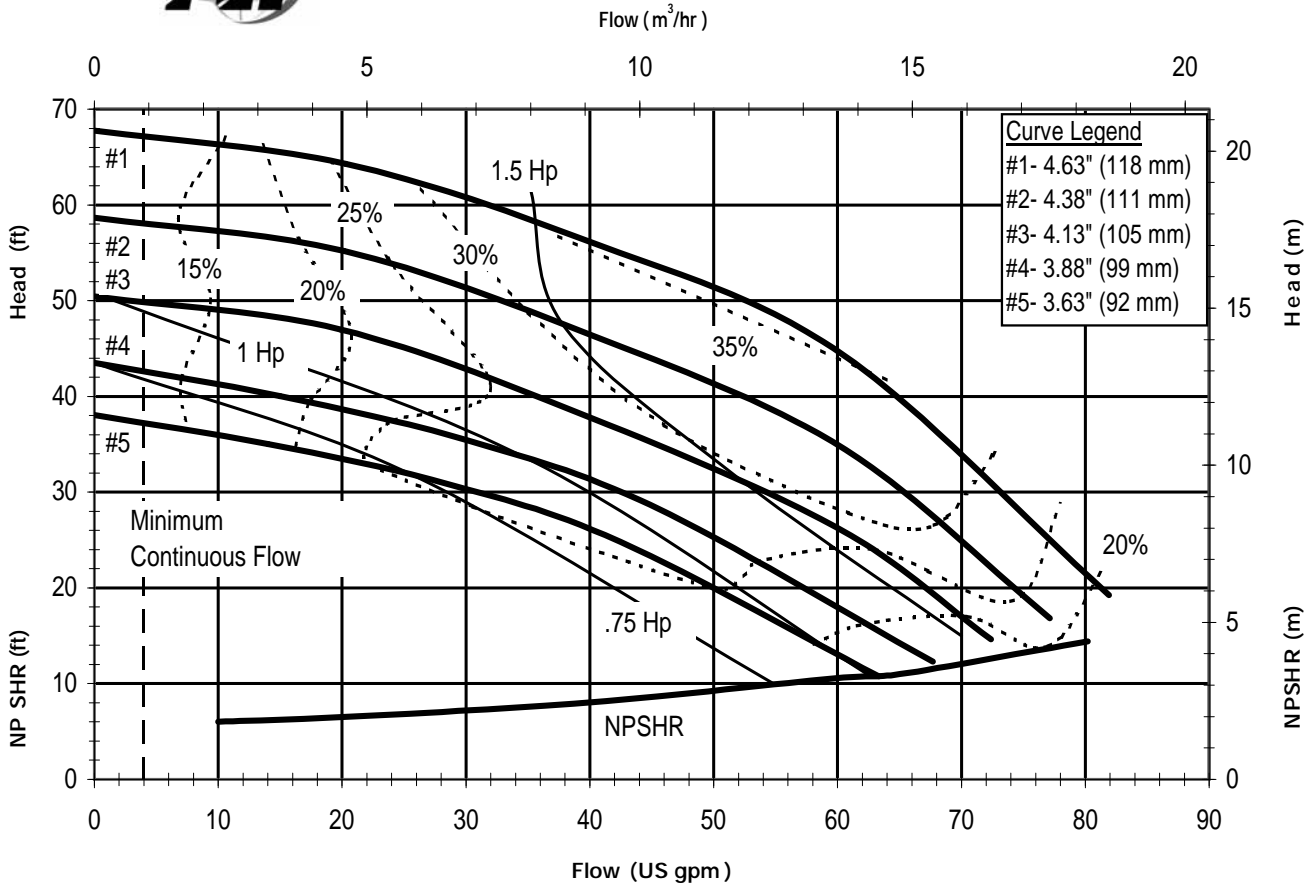

SP11, 2900 RPM, 50-Hz, 3.0 m (10 ft.) Lift
Suction: 1-1/2" FNPT; Discharge: 1-1/2" MNPT

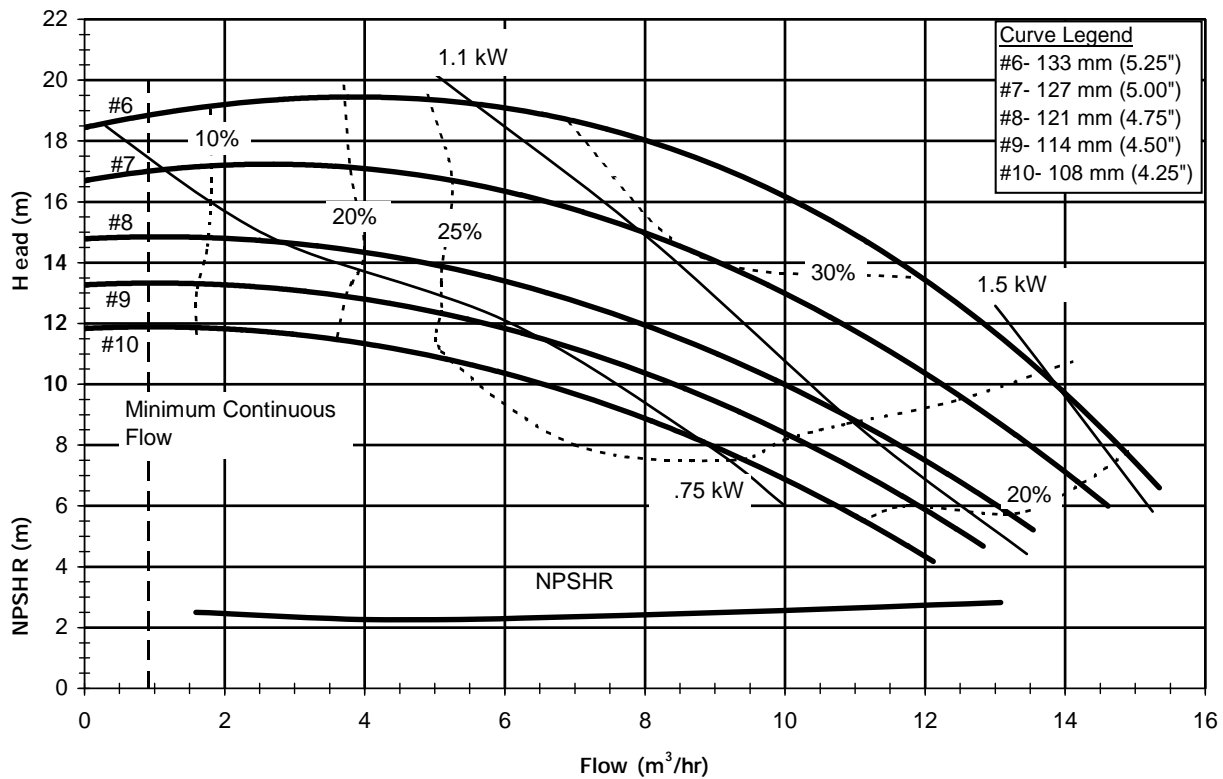



SP11, 3450 RPM, 60-Hz, 15 ft (4.6 m) Lift
Suction: 1-1/2" FNPT; Discharge: 1-1/2" MNPT

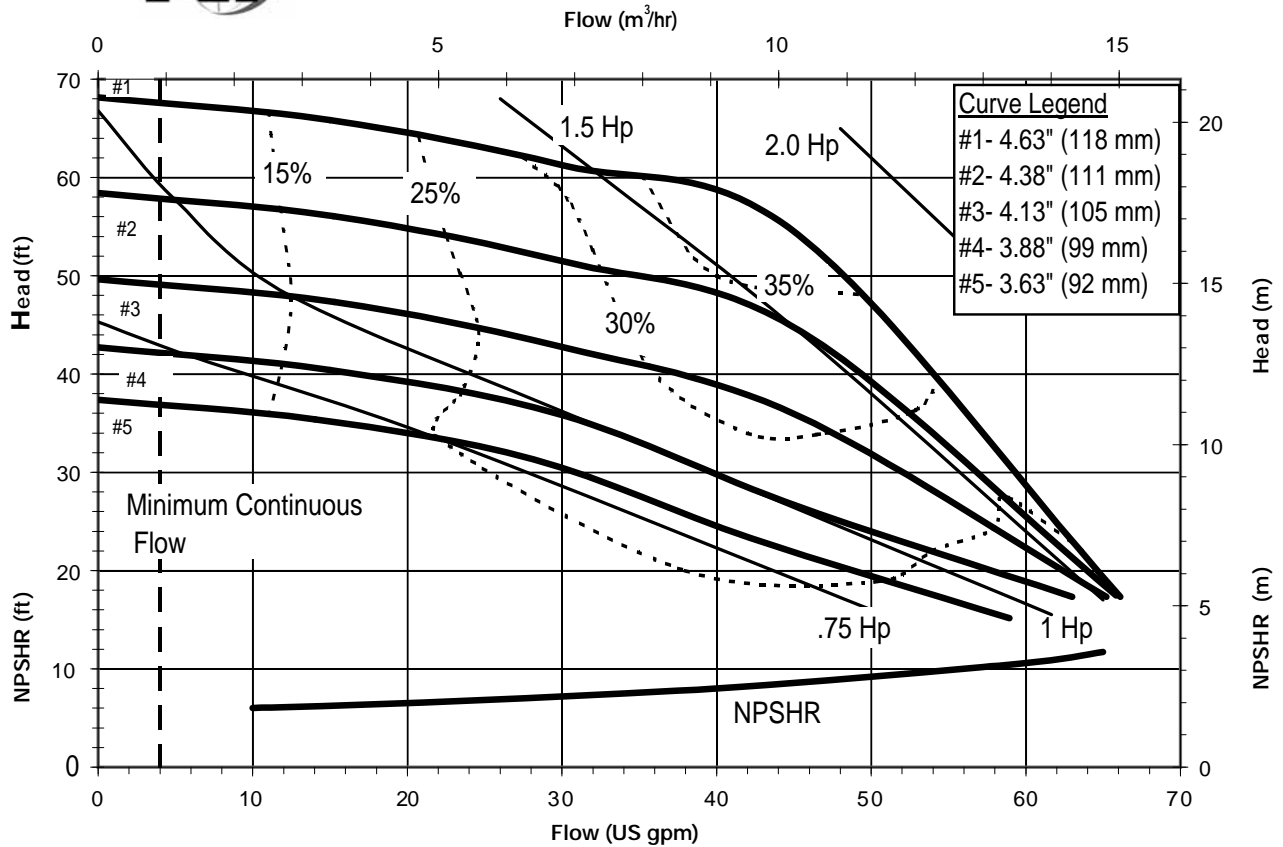

SP11, 2900 RPM, 50-Hz, 4.6 m (15 ft.) Lift
Suction: 1-1/2" FNPT; Discharge: 1-1/2" MNPT

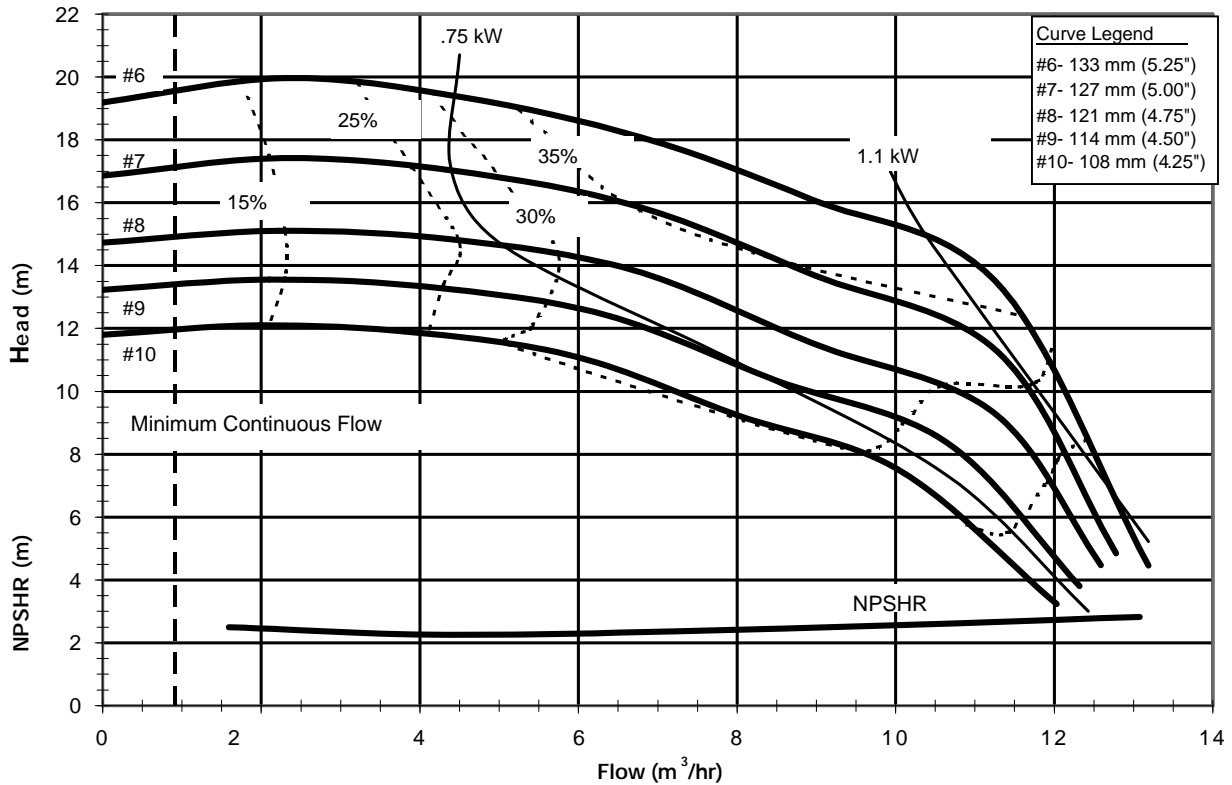



SP15 Performance Curves- Flooded Suction- 60-Hz 3450 RPM
Suction: 1-1/2" FNPT Discharge:1-1/2" MNPT

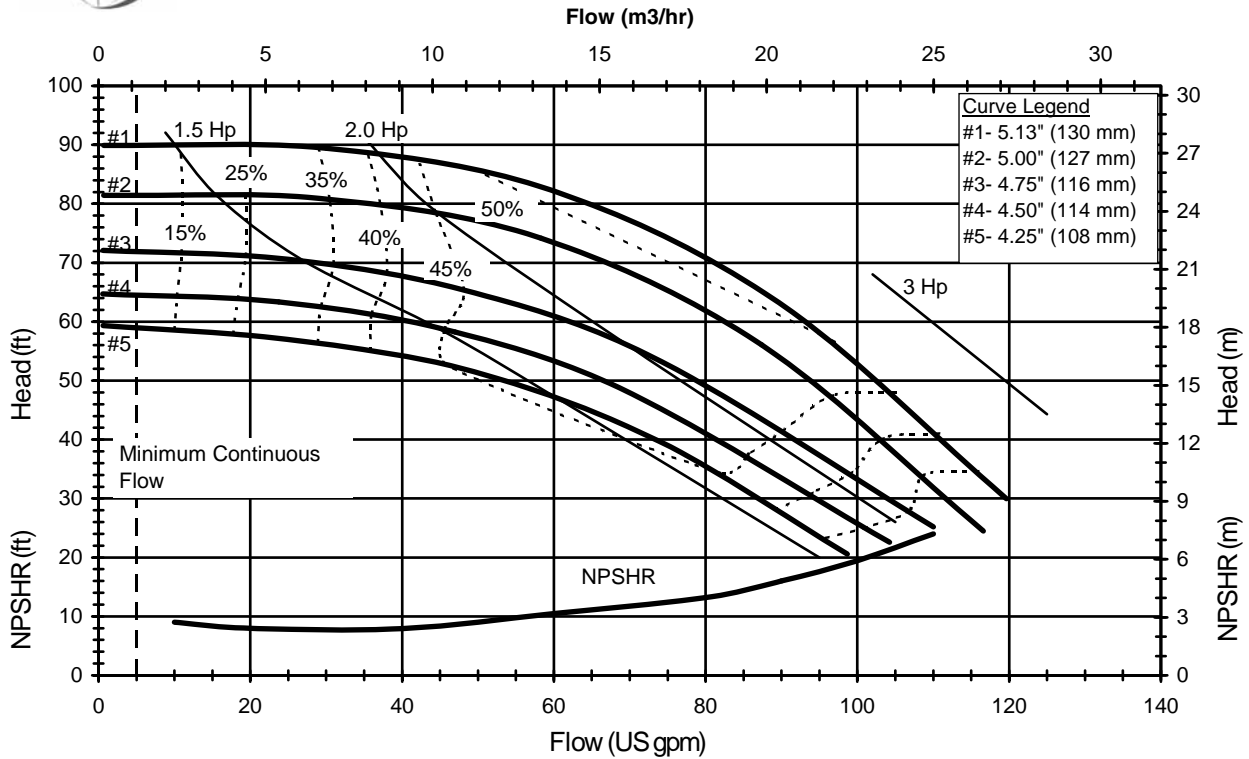

SP15 Performance Curves- Flooded Suction- 50-Hz 2900 RPM
Suction: 1-1/2" FNPT Discharge:1-1/2" MNPT

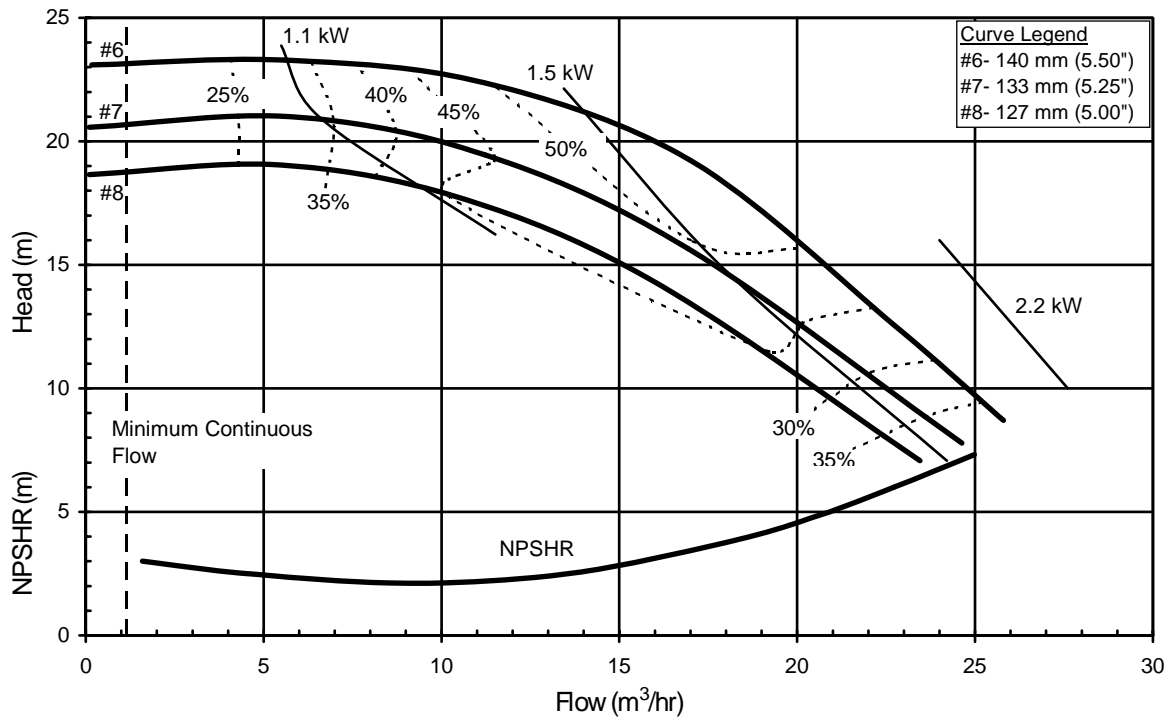

SP1500
 6016 Rev 1
 3-24-08



SP15, 3450 RPM, 60-Hz, 5 ft (1.5 m) Lift
Suction: 1-1/2" FNPT; Discharge: 1-1/2" MNPT

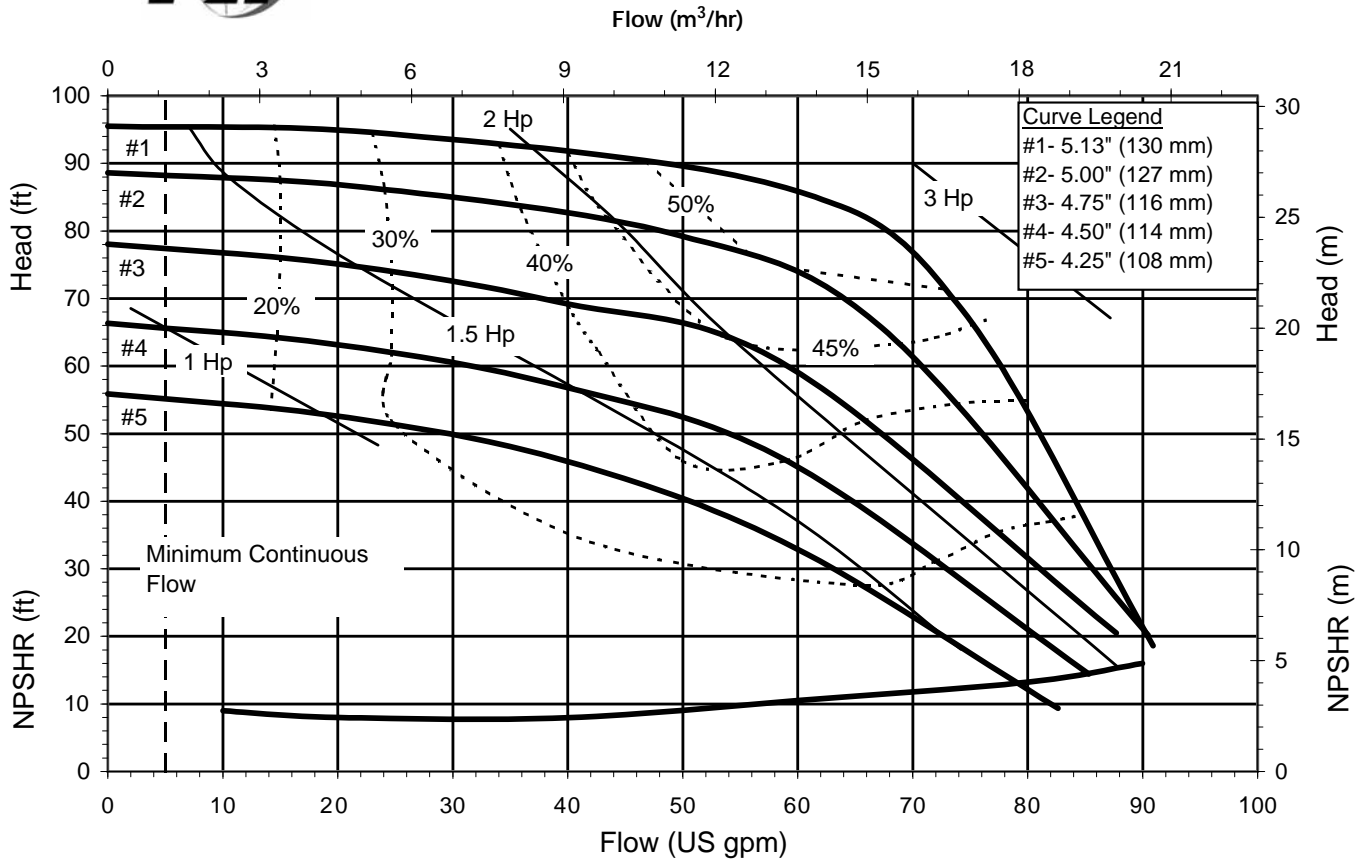

SP15, 2900 RPM, 50-Hz, 1.5 m (5 ft.) Lift
Suction: 1-1/2" FNPT; Discharge: 1-1/2" MNPT

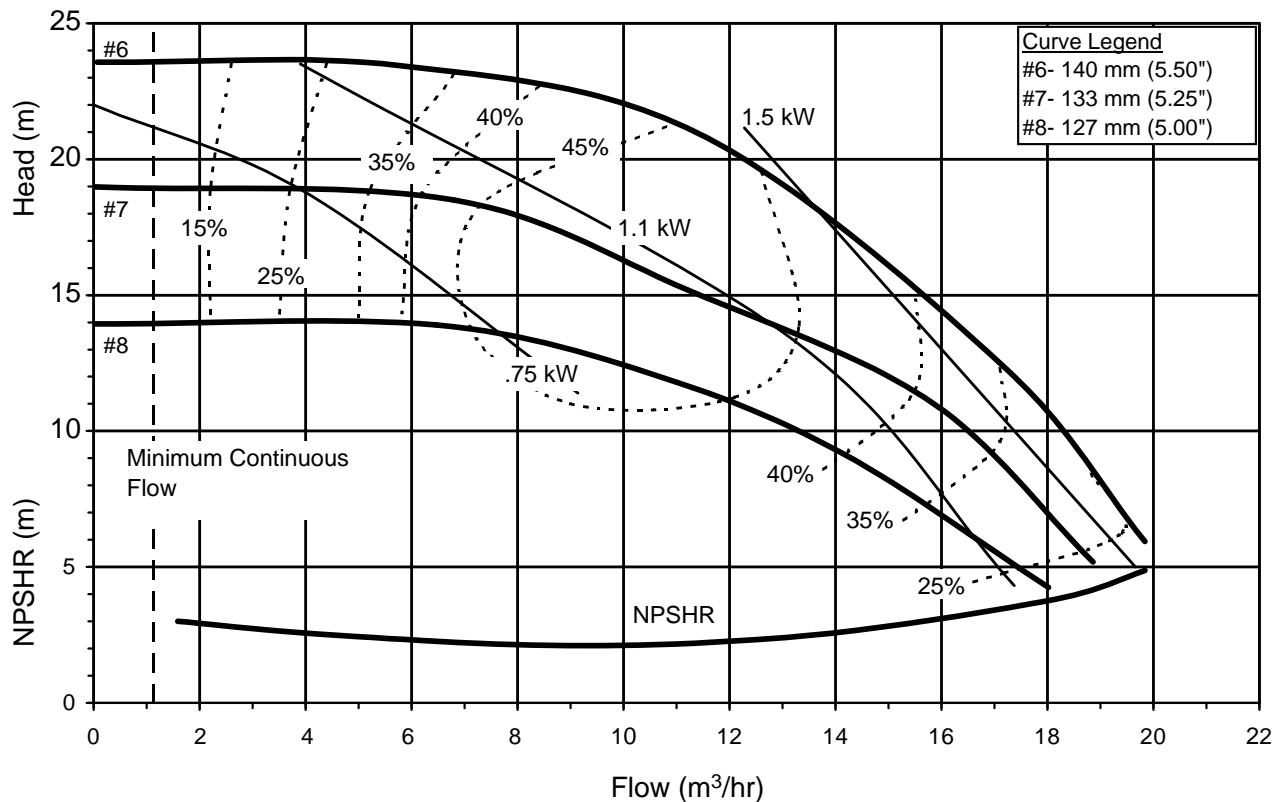



SP15, 3450 RPM, 60-Hz, 10' (3.0 m) Lift
Suction: 1-1/2" FNPT; Discharge: 1-1/2" MNPT

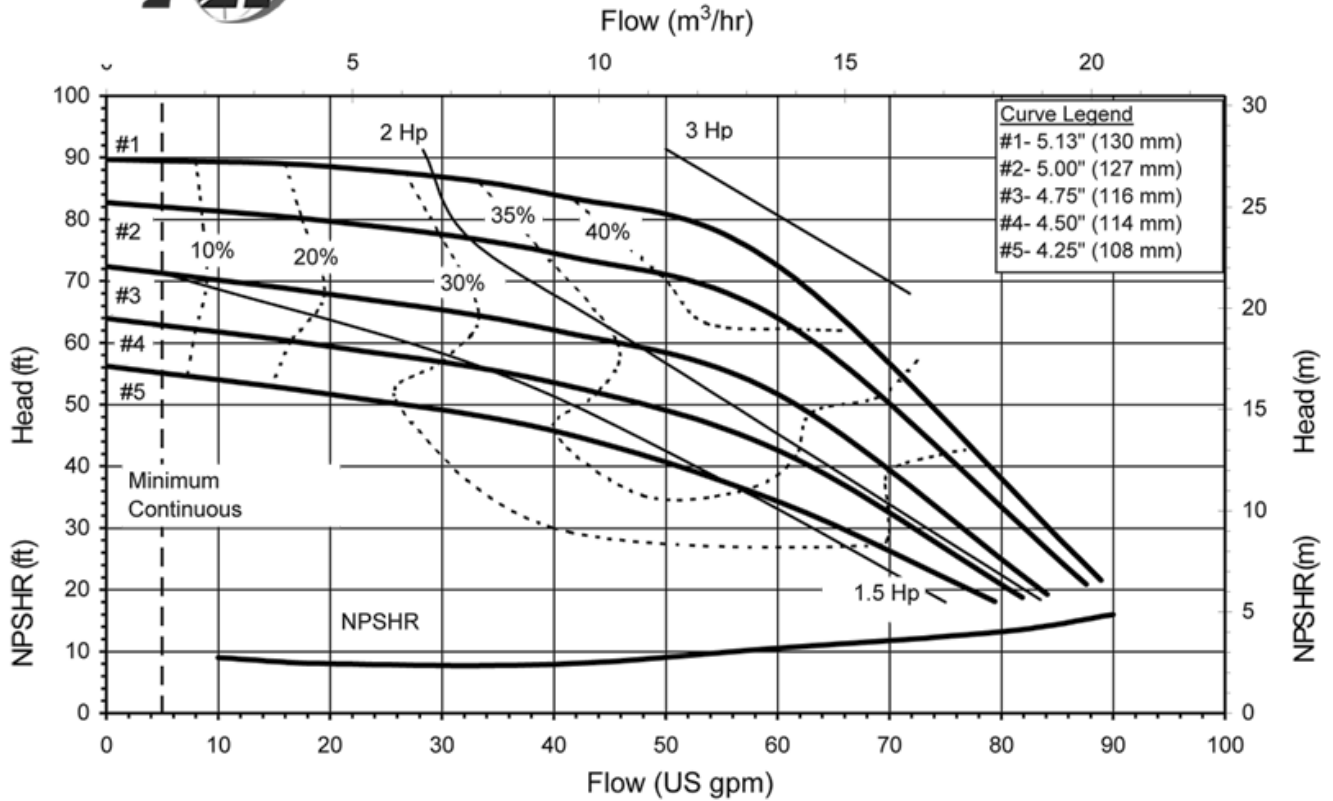

SP15, 2900 RPM, 50-Hz, 3.0 m (10') Lift
Suction: 1-1/2" FNPT; Discharge: 1-1/2" MNPT

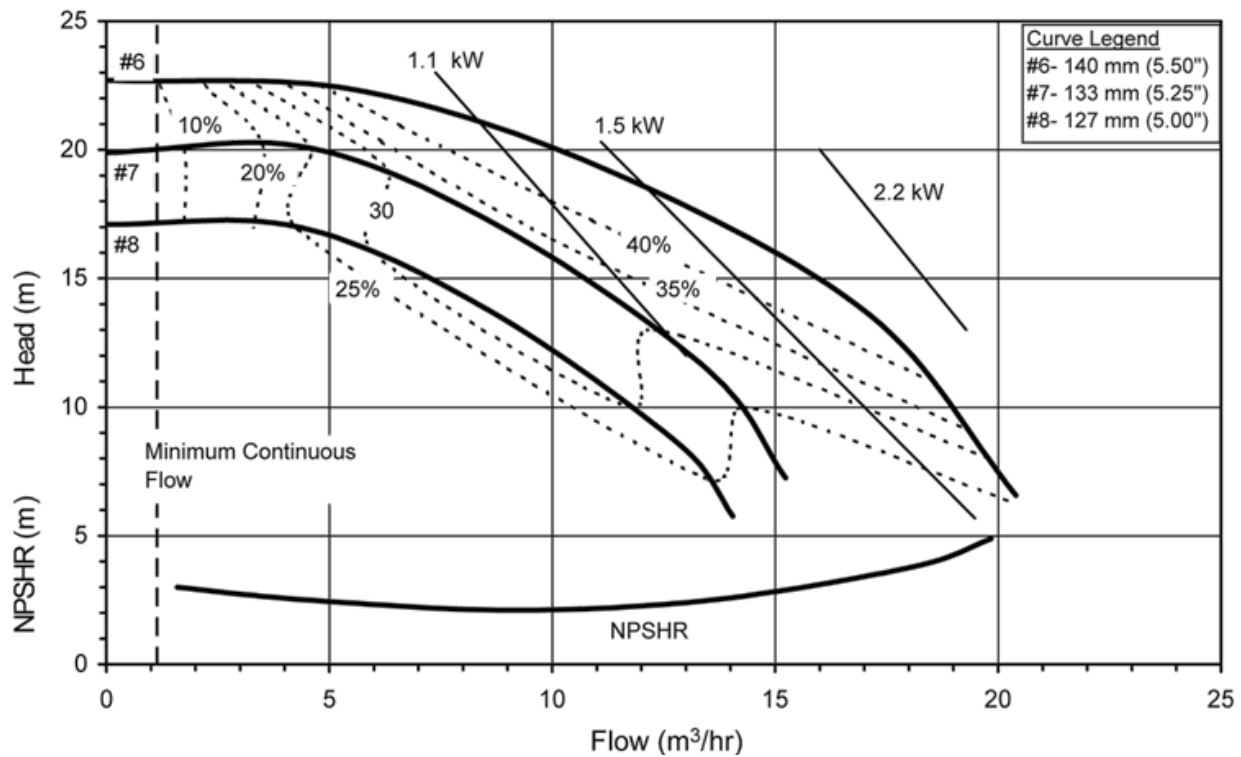



SP15, 3450 RPM, 60-Hz, 15 ft. (4.6 m) Lift
Suction: 1-1/2" FNPT; Discharge: 1-1/2" MNPT

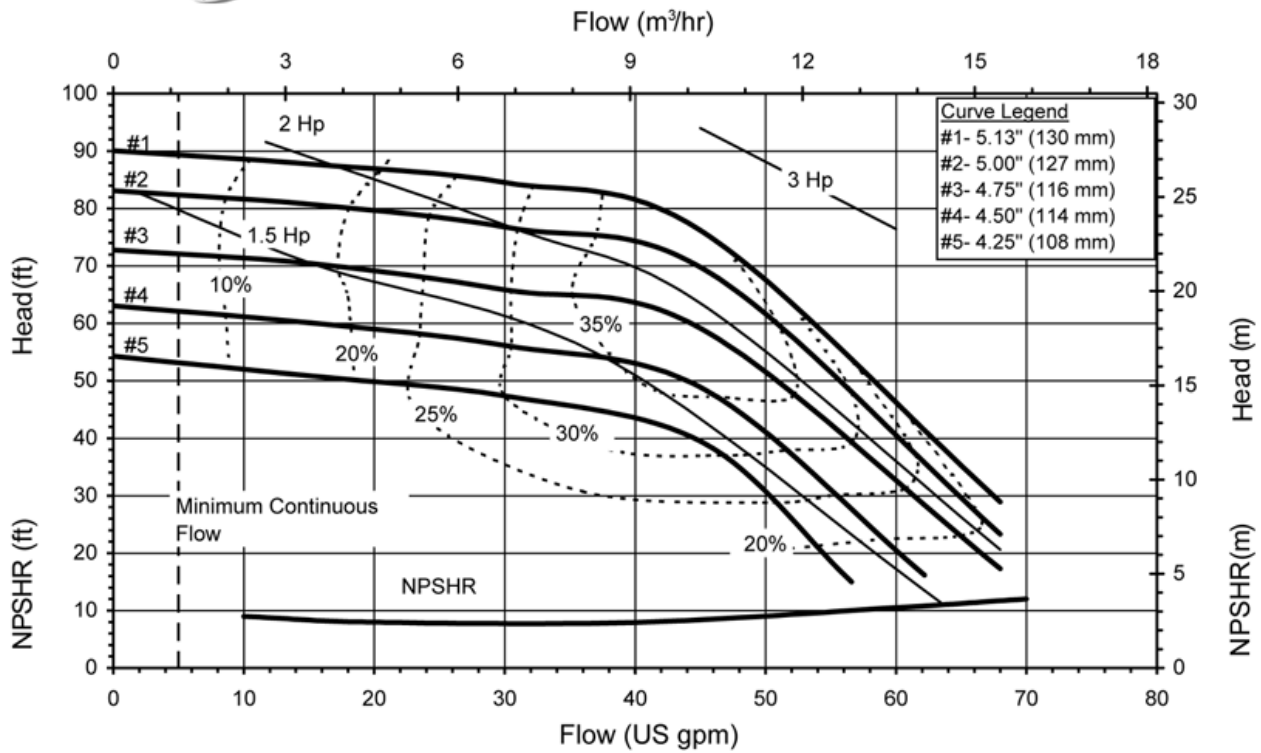

SP15, 2900 RPM, 50-Hz, 4.6 m (15 ft.) Lift
Suction: 1-1/2" FNPT; Discharge: 1-1/2" MNPT

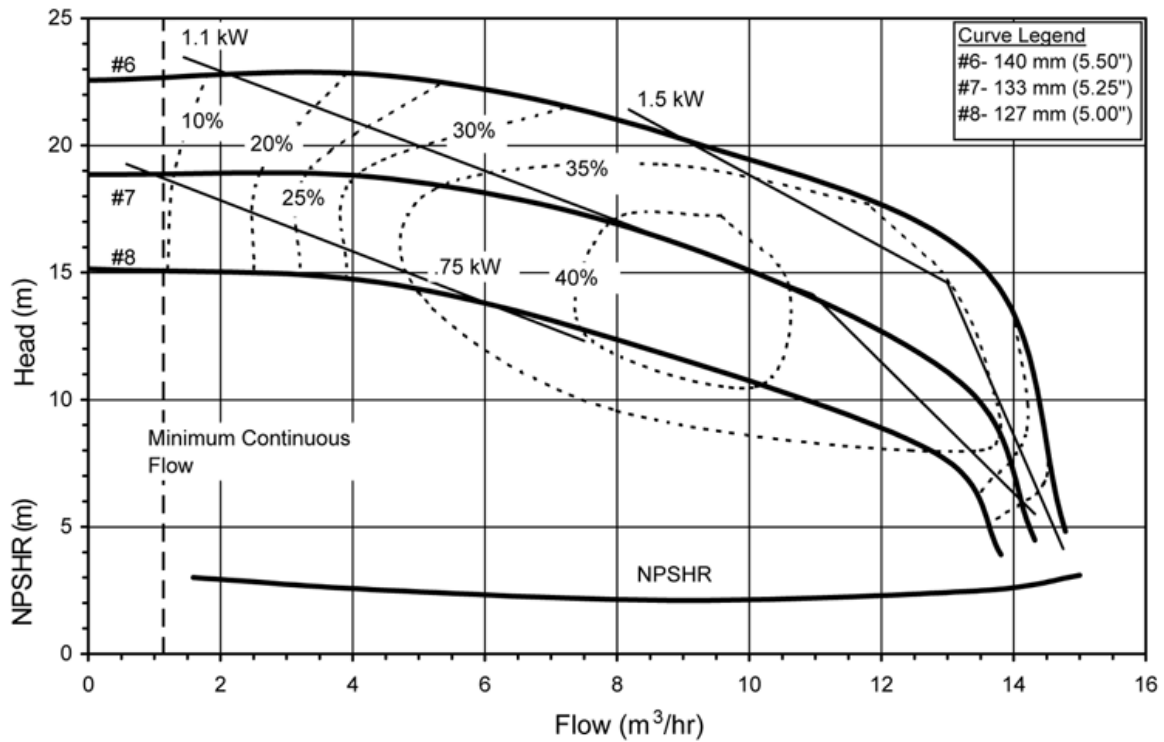



**SP22 Prime Time- 3450 RPM
2" Suction Pipe**

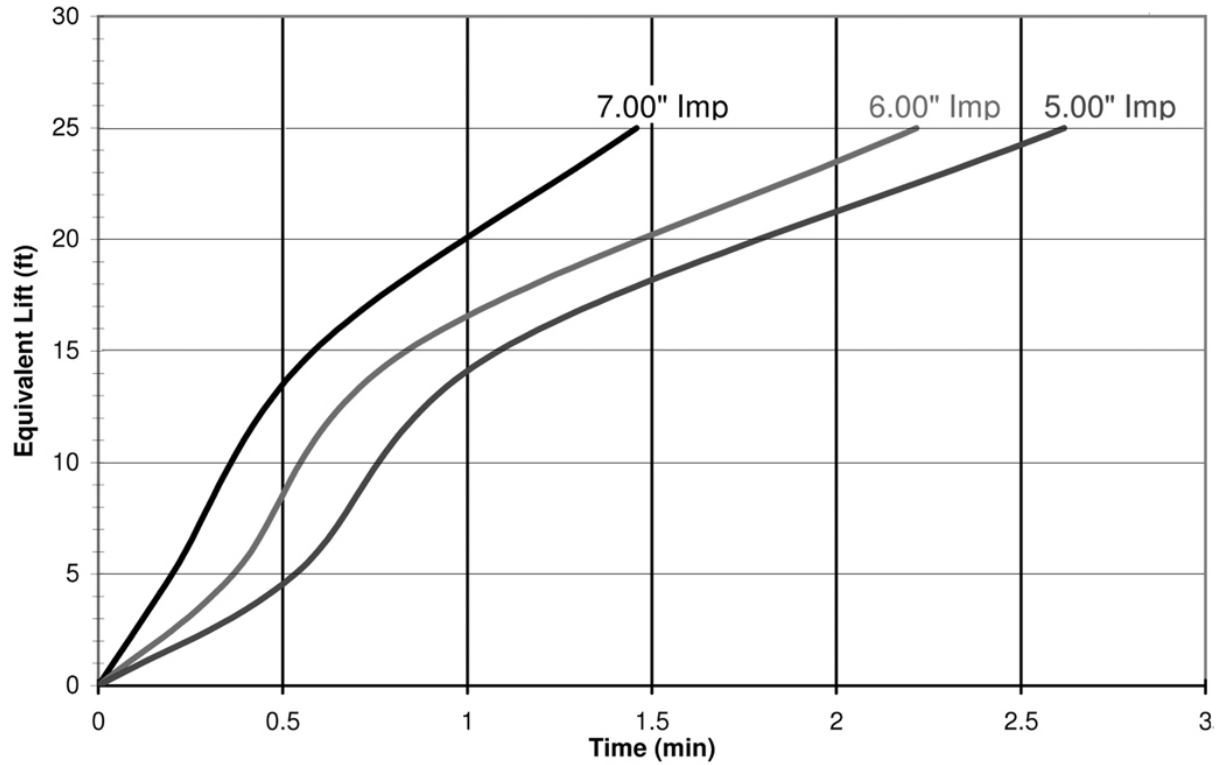

**SP22 Prime Time- 2900 RPM
2" Suction Pipe**

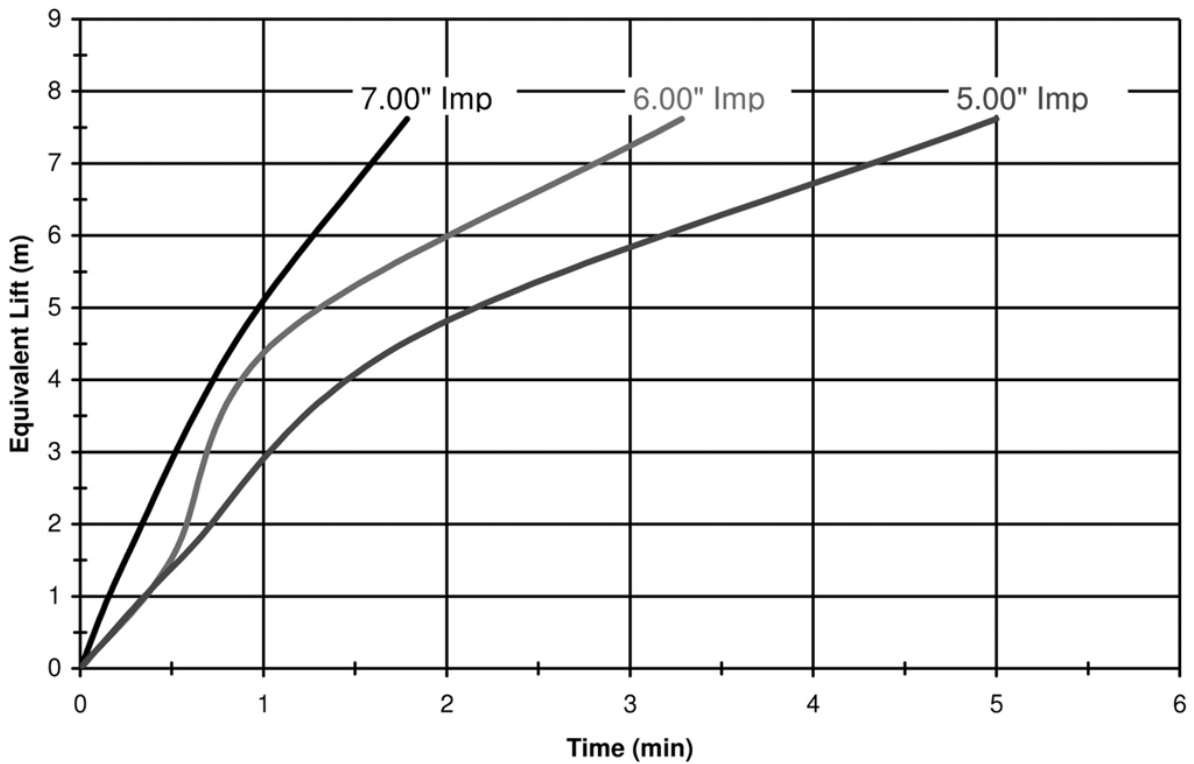

Note: Times shown are guidelines only and may vary depending on system and piping setup



**SP22 Prime Time- 3450 RPM
3" Suction Pipe**

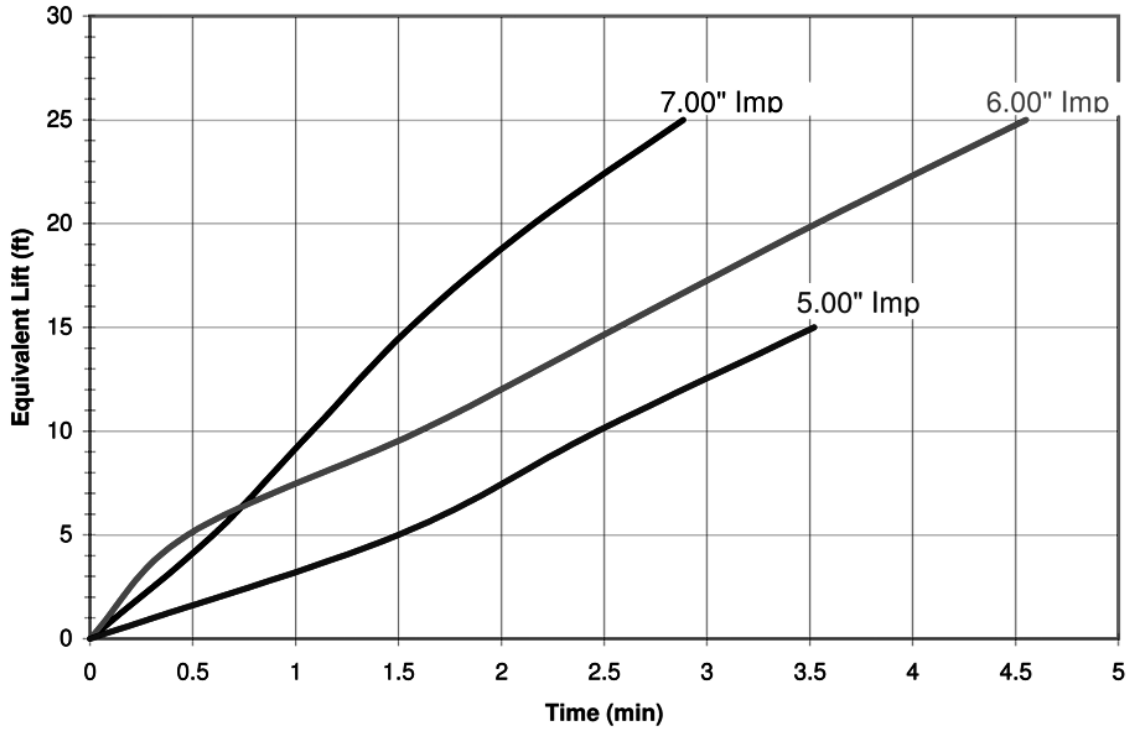

**SP22 Prime Time- 2900 RPM
3" Suction Pipe**

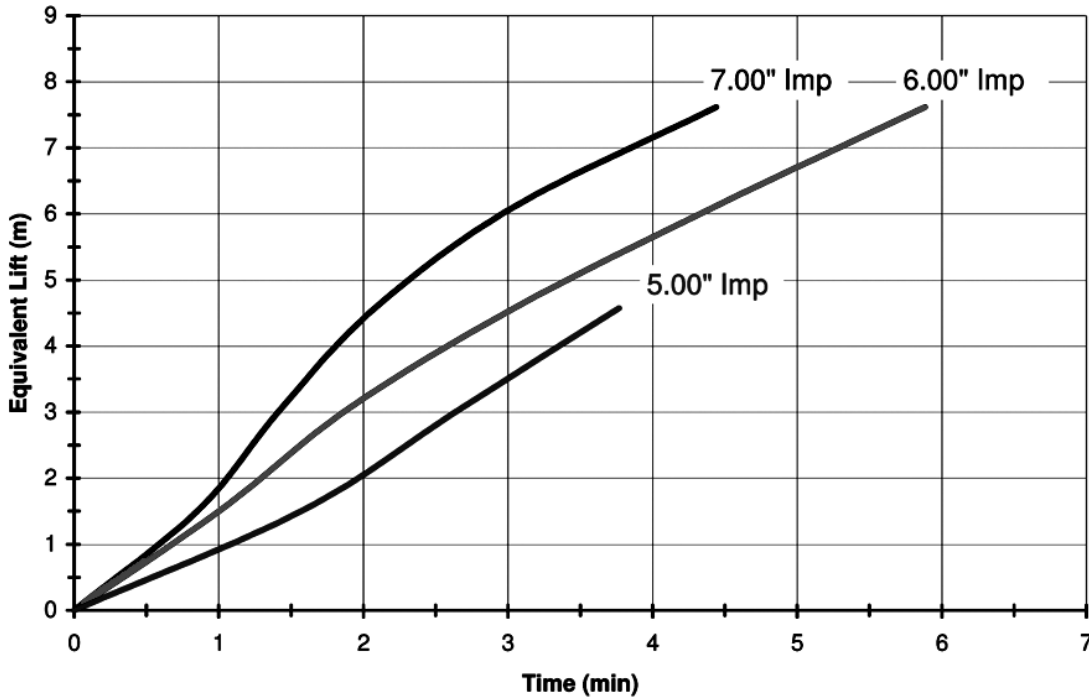

Note: Times shown are guidelines only and may vary depending on system and piping setup
Recommend using 2" suction pipe with impellers less than 5.50" at equivalent lifts greater than 15' (4.6 m)



SP22, 3450 RPM, 60-Hz, Flooded Suction
Suction: 2" FNPT; Discharge: 2" MNPT

Plumb with 2" or 3" Suction and 2" Discharge Pipe

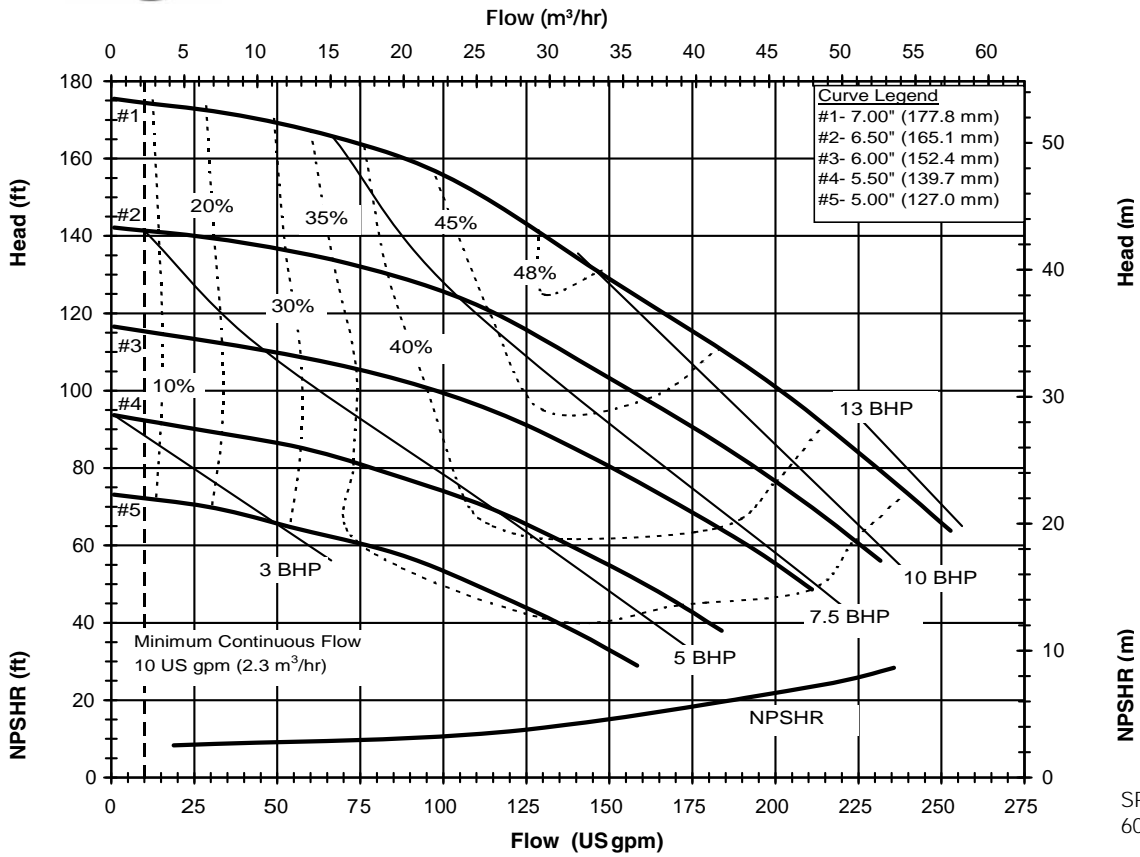

SP2260
6042 Rev 0

SP22, 2900 RPM, 50-Hz, Flooded Suction
Suction: 2" FNPT; Discharge: 2" MNPT

Plumb with 2" or 3" Suction and 2" Discharge Pipe

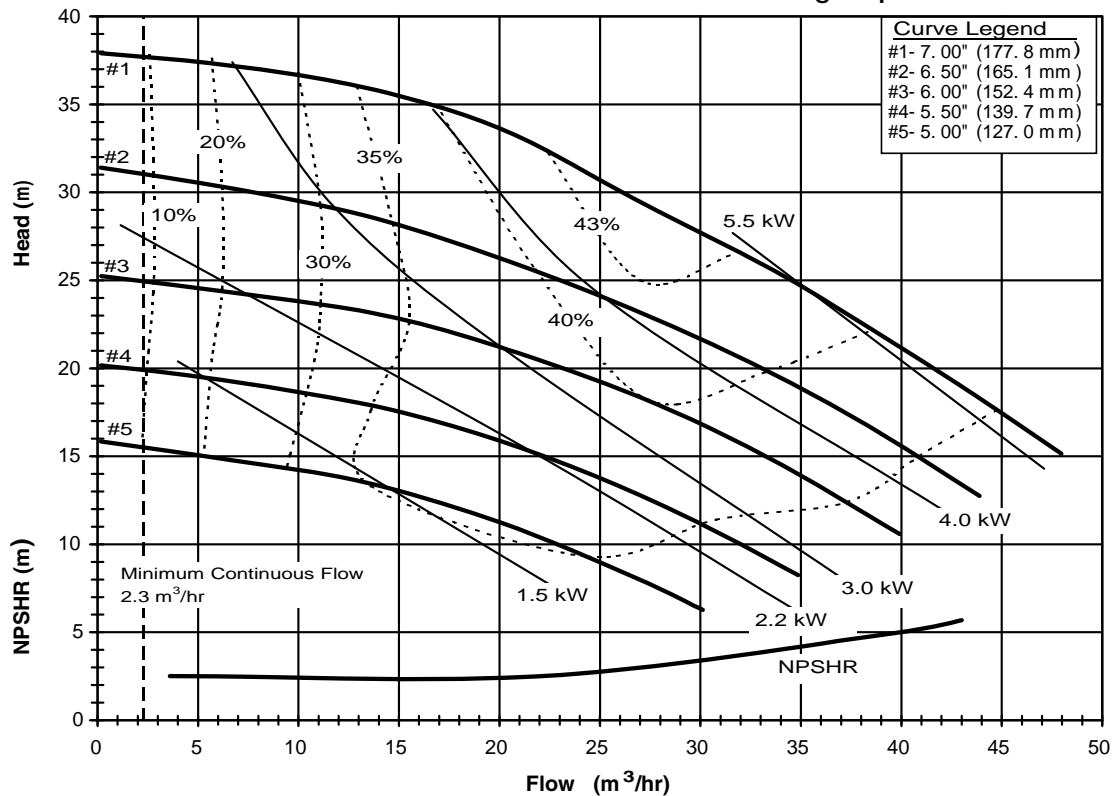

SP2250
6043 Rev 0

NOTES:
FOR POWER REQUIREMENTS ABOVE 10HP @ 60HZ, CONTACT FACTORY FOR ASSISTANCE.



SP22, 3450 RPM, 60-Hz, 5 ft. (1.5 m) Lift
Suction: 2" FNPT; Discharge: 2" MNPT

Plumb with 2" Suction and 2" Discharge Pipe

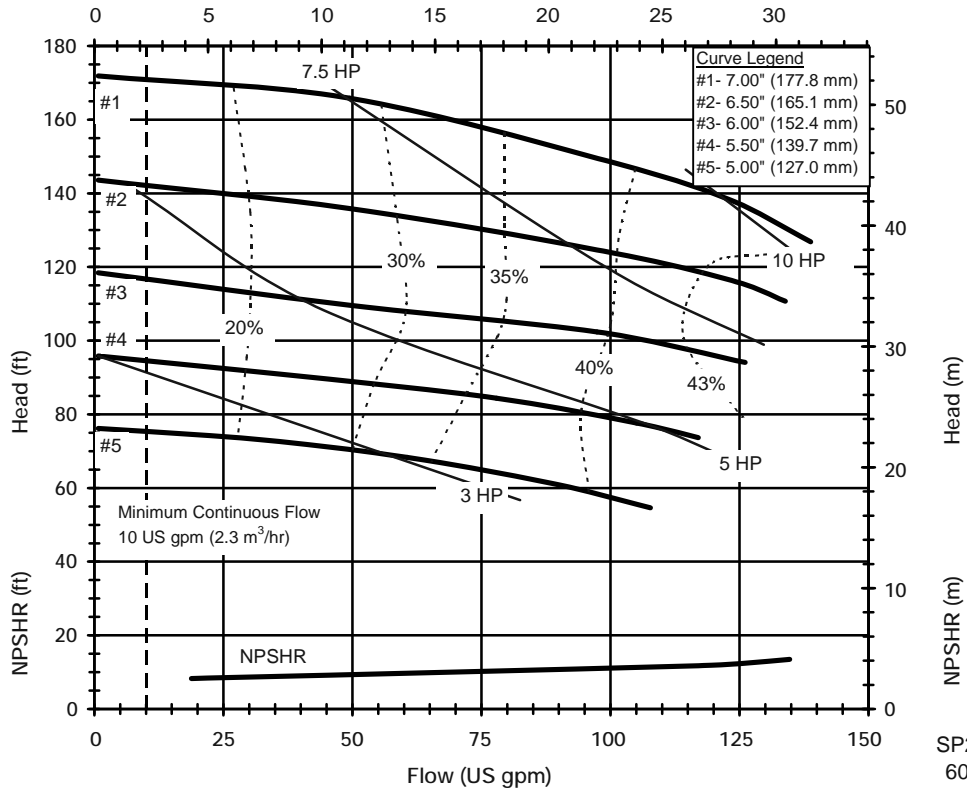

SP22, 2900 RPM, 50-Hz, 1.5 m (5 ft.) Lift
Suction: 2" FNPT; Discharge: 2" MNPT

Plumb with 2" Suction and 2" Discharge Pipe

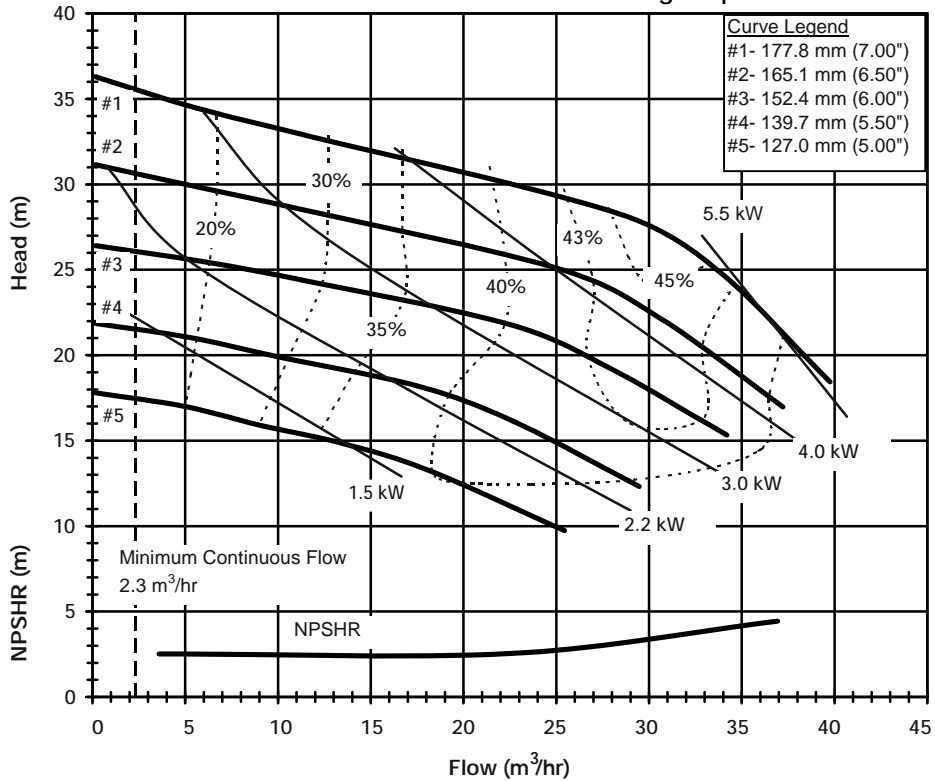

NOTE
CURVES SHOWN WERE TESTED USING 2" SUCTION PIPING.
FOR POWER REQUIREMENTS ABOVE 10 HP @ 60HZ, CONTACT FACTORY FOR ASSISTANCE.



SP22, 3450 RPM, 60-Hz, 10 ft. (3 m) Lift

Suction: 2" FNPT; Discharge: 2" MNPT

Plumb with 2" Suction and 2" Discharge Pipe

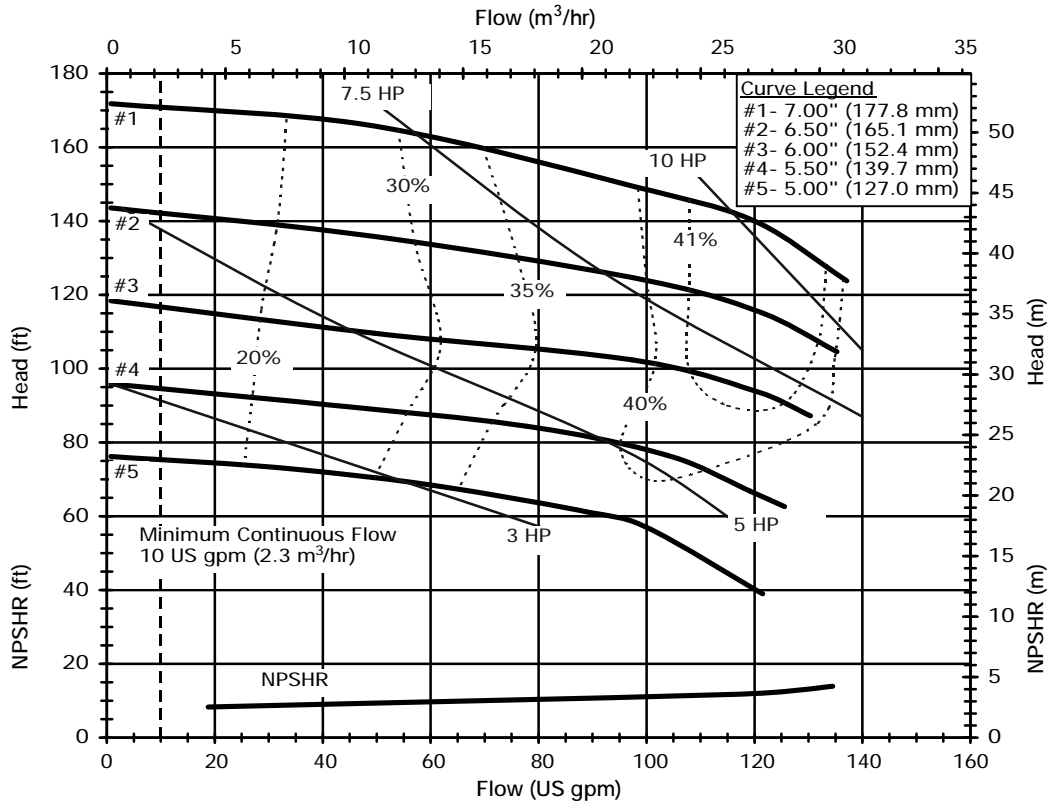

SP22, 2900 RPM, 50-Hz, 3 m (10 ft.) Lift

Suction: 2" FNPT; Discharge: 2" MNPT

Plumb with 2" Suction and 2" Discharge Pipe

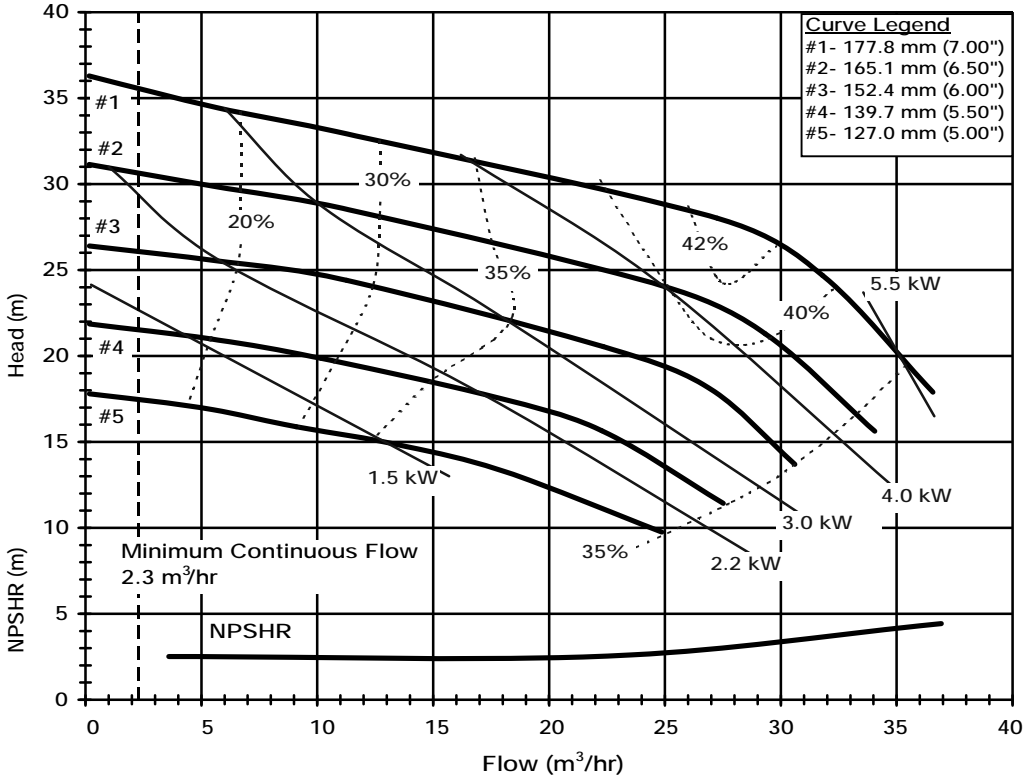

NOTES:
CURVES SHOWN WERE TESTED USING 2" SUCTION PIPING.
FOR POWER REQUIREMENTS ABOVE 10 HP @ 60HZ, CONTACT FACTORY FOR ASSISTANCE.



SP22, 3450 RPM, 60-Hz, 15 ft. Lift (4.6 m)

Suction: 2" FNPT; Discharge: 2" MNPT

Plumb with 2" Suction and 2" Discharge Pipe

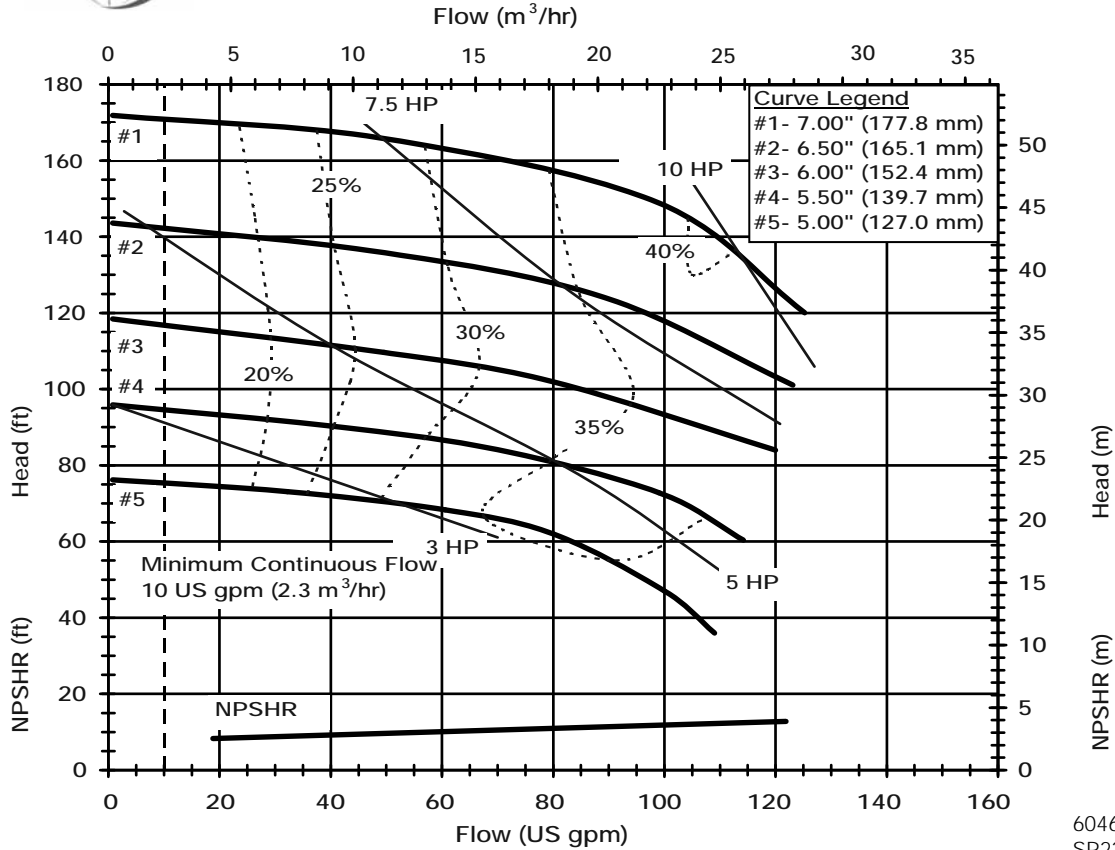

6046 REV 0
SP22 6015-2

SP22, 2900 RPM, 50-Hz, 4.6 m (15 ft.) Lift

Suction: 2" FNPT; Discharge: 2" MNPT

Plumb with 2" Suction and 2" Discharge Pipe

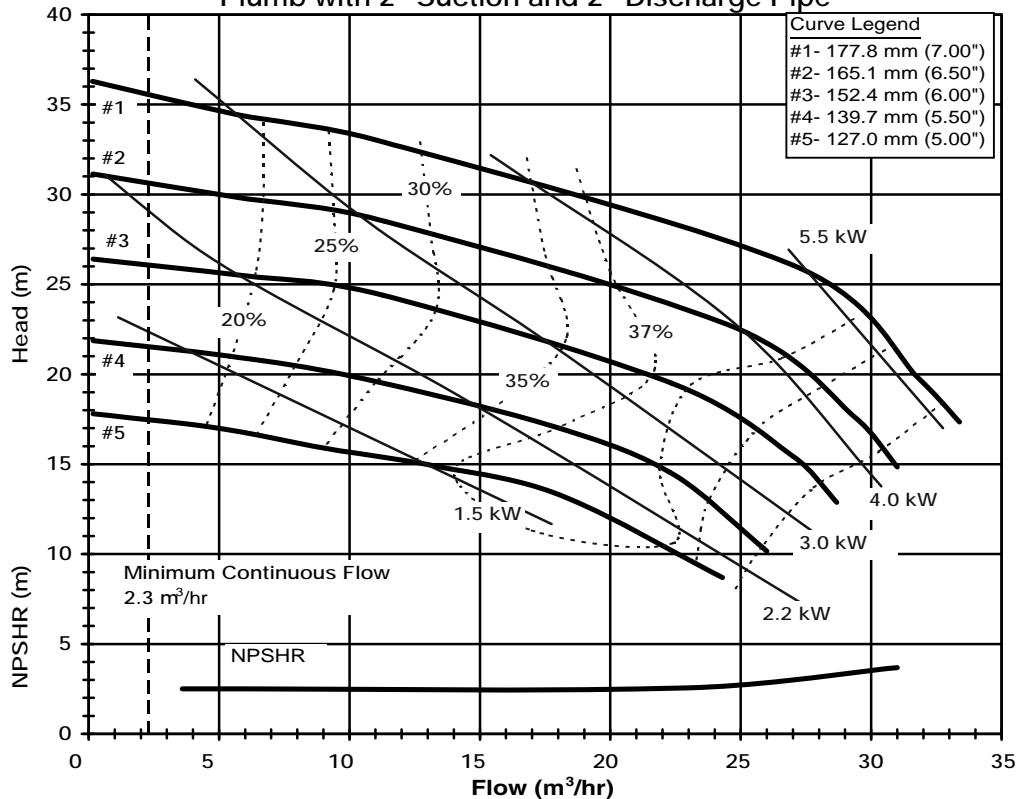

6047 REV 0
SP22 5015-2

NOTES

FTI RECOMMENDS USING 2" SUCTION PIPING WITH 5" IMPELLER AT LIFTS OF 15' (4.6 m) AND GREATER. FOR POWER REQUIREMENTS ABOVE 10HP @ 60HZ, CONTACT FACTORY FOR ASSISTANCE.



SP22, 3450 RPM, 60-Hz, 5 ft. (1.5 m) Lift
 Suction: 2" FNPT; Discharge: 2" MNPT
 Plumb with 3" Suction and 2" Discharge Pipe

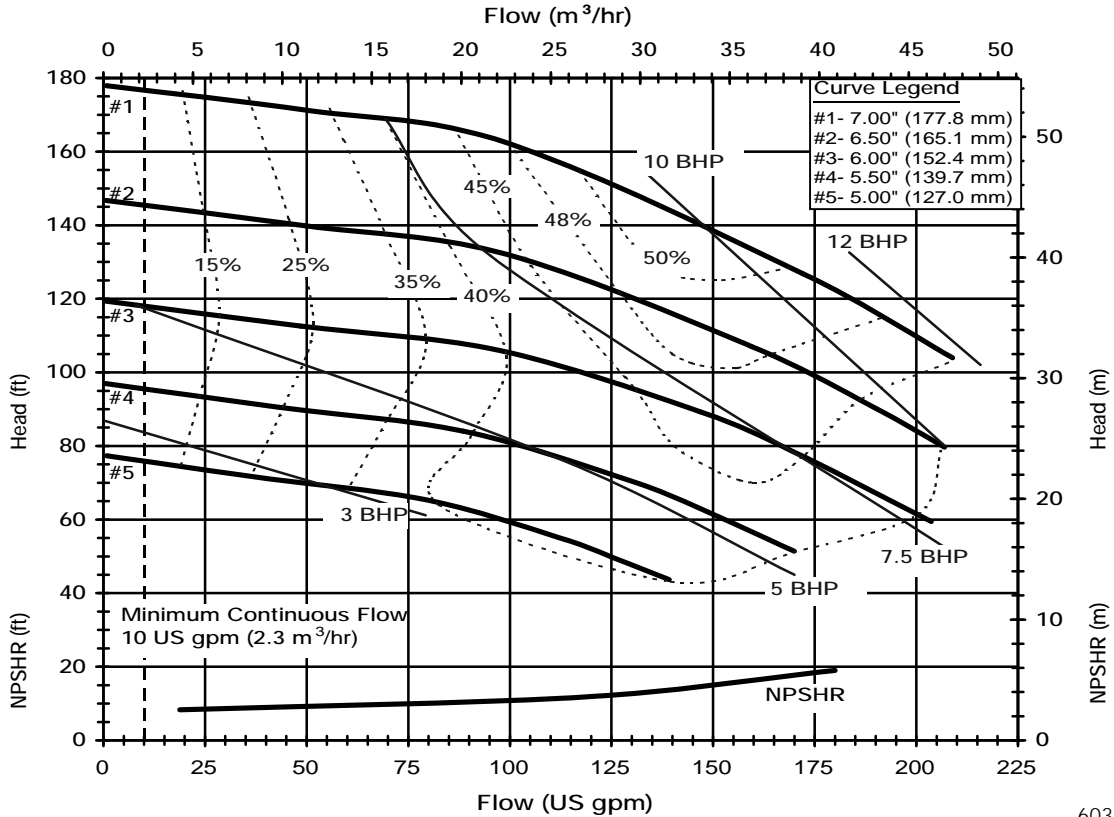

6036 REV 0
 SP22 6005

SP22, 2900 RPM, 50-Hz, 1.5 m (5 ft.) Lift
 Suction: 2" FNPT; Discharge: 2" MNPT
 Plumb with 3" Suction and 2" Discharge Pipe

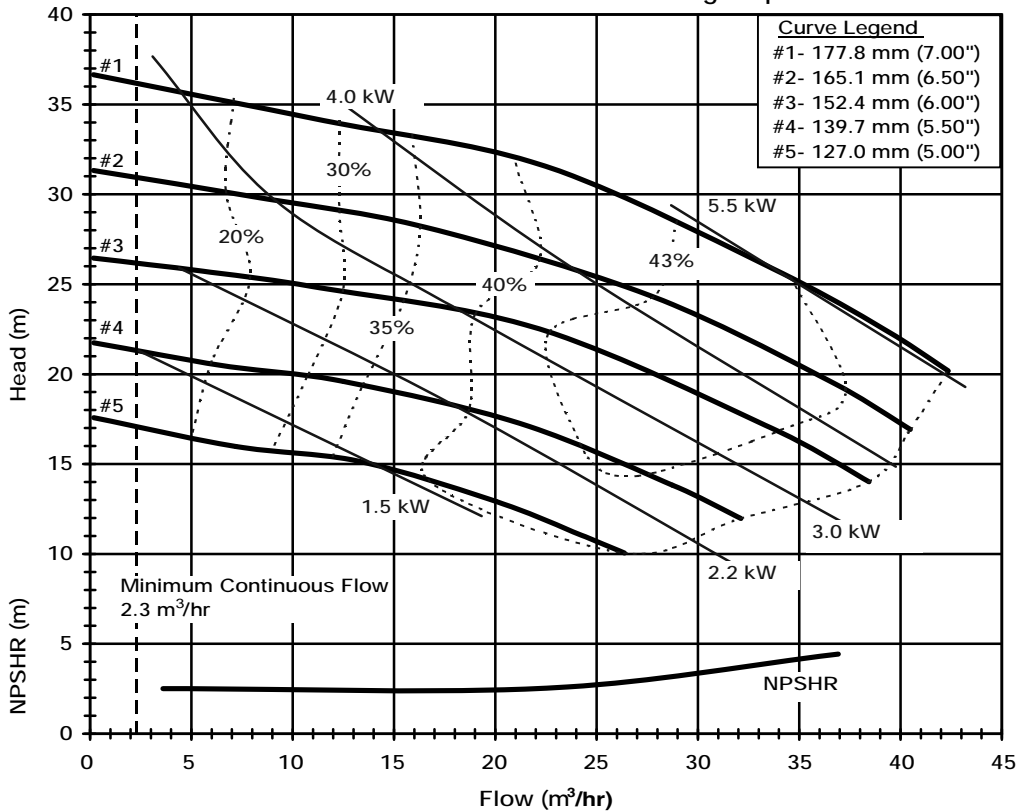

6037 REV 0
 SP22 5005

CURVES SHOWN WERE TESTED USING 3" SUCTION PIPING.



SP22, 3450 RPM, 60-Hz, 10 ft. (3 m) Lift
Suction: 2" FNPT; Discharge: 2" MNPT

Plumb with 3" Suction and 2" Discharge Pipe

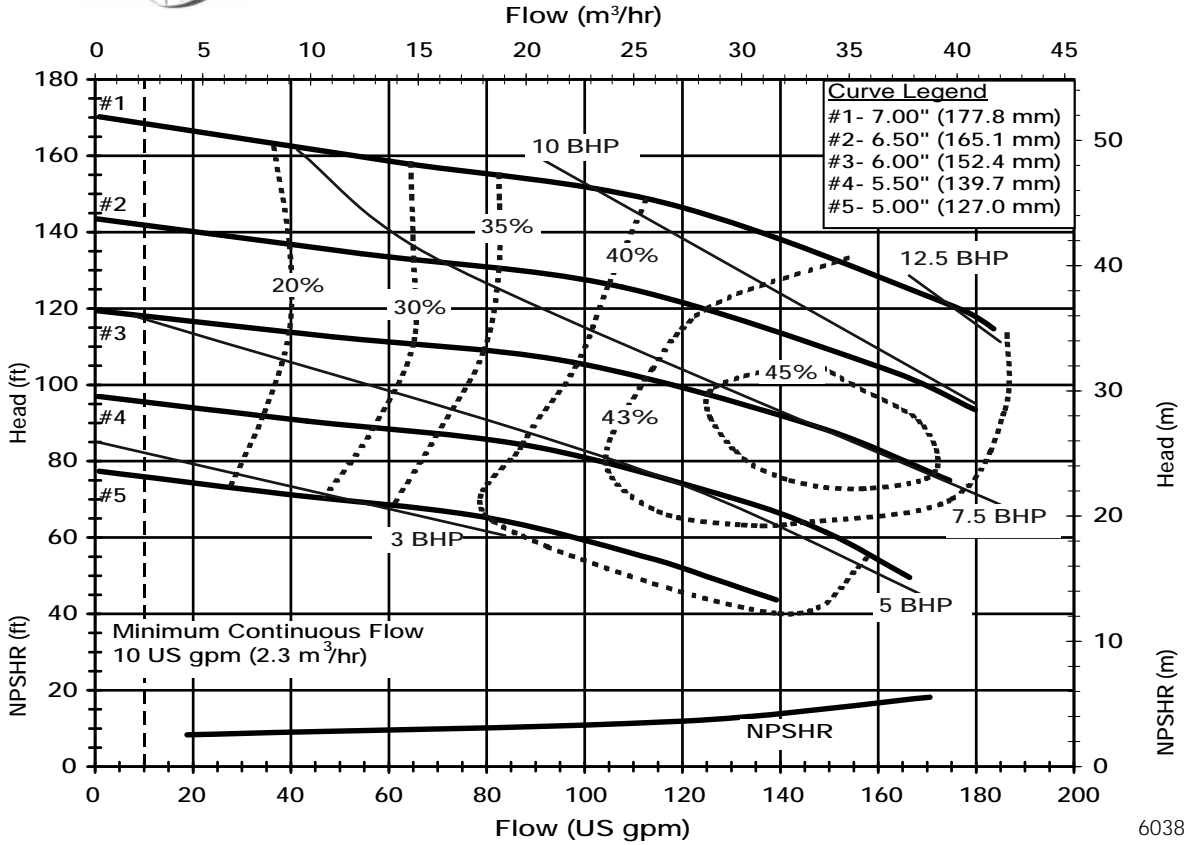

6038 REV 0
SP22 6010

SP22, 2900 RPM, 50-Hz, 3 m (10 ft.) Lift
Suction: 2" FNPT; Discharge: 2" MNPT

Plumb with 3" Suction and 2" Discharge Pipe

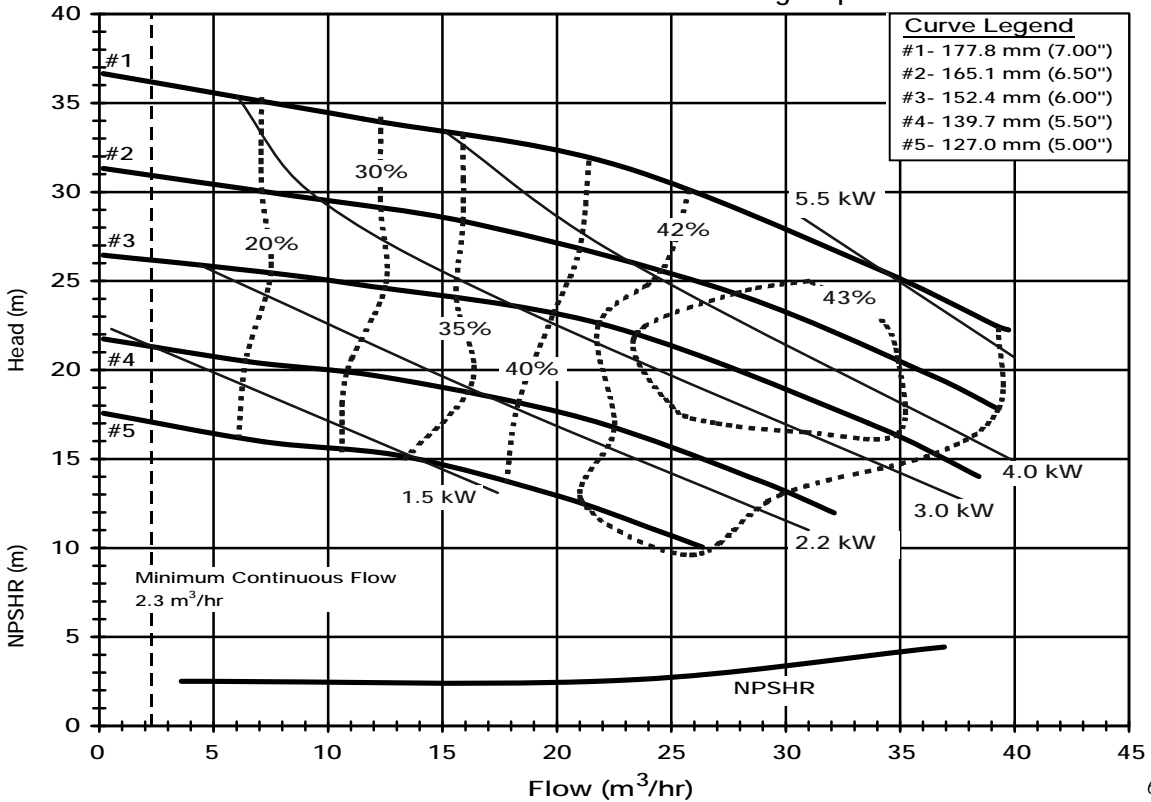

6039 REV 0
SP22 5010

NOTE: CURVES SHOWN WERE TESTED USING 3" SUCTION PIPING



SP22, 3450 RPM, 60-Hz, 15 ft. Lift (4.6 m)

Suction: 2" FNPT; Discharge: 2" MNPT

Plumb with 3" Suction and 2" Discharge Pipe

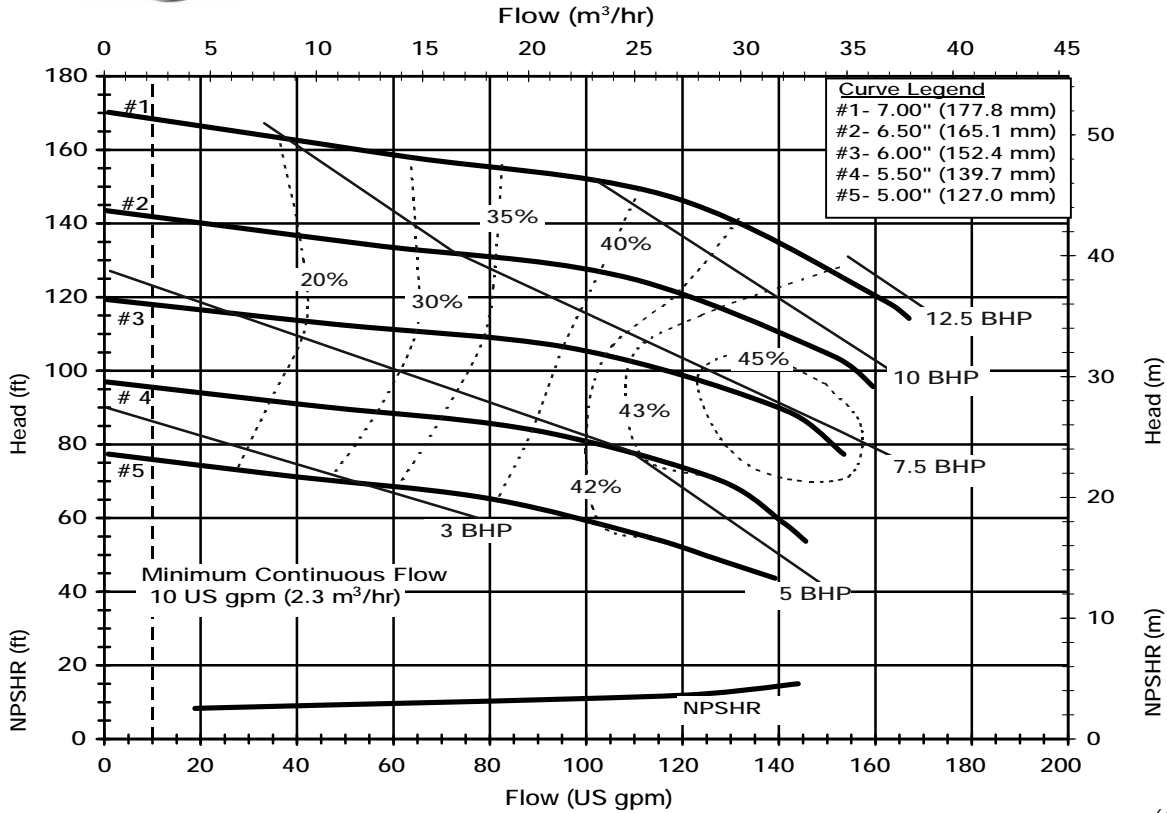

6040 REV 0
SP22 6015

SP22, 2900 RPM, 50-Hz, 4.6 m (15 ft.) Lift

Suction: 2" FNPT; Discharge: 2" MNPT

Plumb with 3" Suction and 2" Discharge Pipe

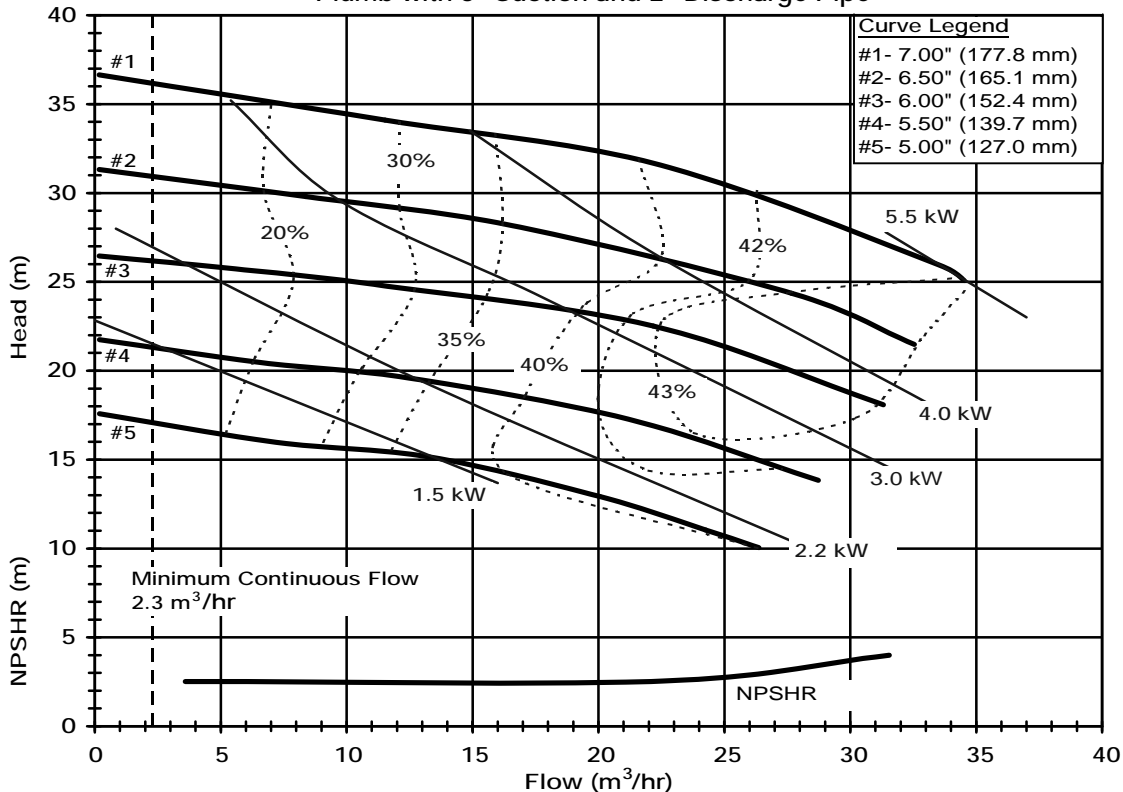

6041 REV 0
SP22 5015

NOTES:

CURVES SHOWN WERE TESTED USING 3" SUCTION PIPING.

RECOMMEND USING 2" SUCTION PIPING WITH IMPELLERS LESS THAN 5.50" (139.7 MM) AT EQUIVALENT LIFTS GREATER THAN 15' (4.6M).

FOR POWER REQUIREMENTS ABOVE 10 HP, CONTACT FACTORY FOR ASSISTANCE.