



SP22 Series Self-Priming Pumps

Assembly, Installation and Operation Manual

Literature ID No. FT08-1024G

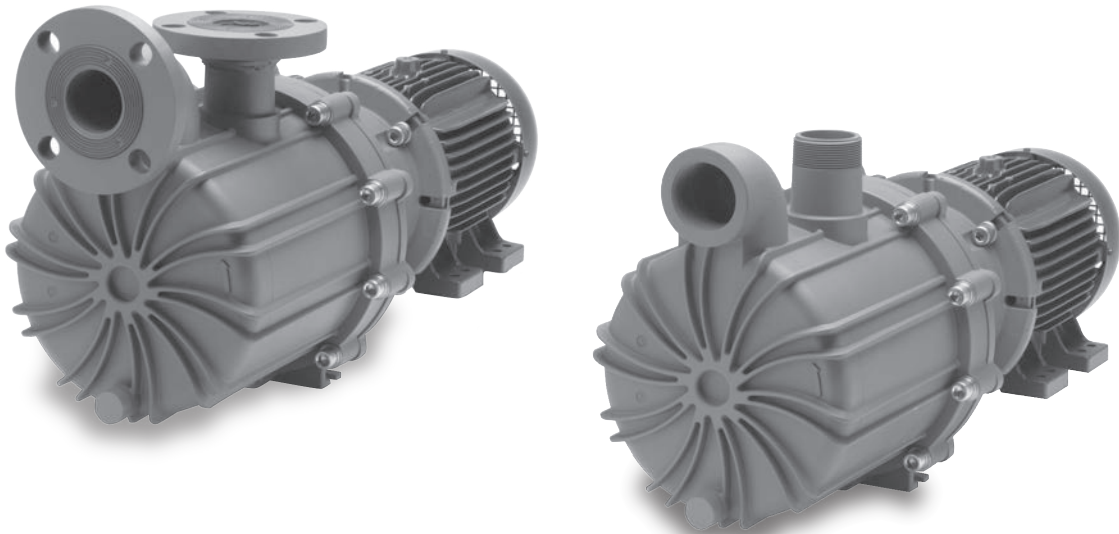

TABLE OF CONTENTS

Important Notice	3
Chemical Reaction Disclaimer	3
Safety Precautions	3
SP22 Capabilities.....	4
SP22 Prime Time Curves	5
Section I - Assembly	
Pumps with Motors	6
Pumps without Motors	6
Section II - Installation	7
Mounting.....	7
Motor/Electrical.....	8
Section III - Start-up and Operation	8
Section IV - Shut Down	8
Flush Systems	8
Maintenance	9
Section V - Disassembly	9-12
Outer Drive Replacement	11
Impeller Thrust Ring	11
Impeller Bushing	11
Impeller Disassembly	11
Reassembly	11-12
SP22 Part Number Explanation	13
Spare Parts Diagram.....	14
Spare Parts List	15-18
Section VI - Troubleshooting	19
Section VII - Warranty	19



NOTE: Maintenance videos are now available on line at www.finishthompson.com.

FTI Contacts:

Tech Service: 1-800-888-3743; techservice@finishthompson.com

Order Fax: 1-814-459-3460 or 1-814-455-8518

Sales: 1-800-934-9384 (toll free U.S. and Canada; 1-814-455-4478)

IMPORTANT NOTICE

U.S. Export Administration Regulations, pursuant to ECCN 2B350, prohibit the export or reexport to certain enumerated countries of sealless centrifugal pumps in which all wetted materials are constructed from fluoropolymers without first applying for and obtaining a license from the U.S. Bureau of Industry and Security (BIS). This affects all Finish Thompson magnetic-drive pumps constructed from PVDF or lined with ETFE. Please contact the BIS (www.bis.doc.gov) or Finish Thompson with questions regarding the Regulations or a list of the countries to which they apply.

Chemical Reaction Disclaimer

The user must exercise primary responsibility in selecting the product's materials of construction, which are compatible with the fluid(s) that come(s) in contact with the product. The user may consult Finish Thompson, Inc. (manufacturer) and a manufacturer's representative/distributor agent to seek a recommendation of the product's material of construction that offers the optimum available chemical compatibility.

However neither manufacturer nor agent shall be liable for product damage or failure, injuries, or any other damage or loss arising out of a reaction, interaction or any chemical effect that occurs between the materials of the product's construction and fluids that come into contact with the product's components.

Safety Precautions

⚠ WARNING: READ THIS MANUAL COMPLETELY BEFORE INSTALLING AND OPERATING THIS UNIT. FAILURE TO FOLLOW THESE PRECAUTIONS CAN RESULT IN SERIOUS INJURY OR DEATH.

⚠ WARNING: Magnetic field hazard. This pump contains powerful magnets. Exposed magnets (pump not connected to motor) produce powerful magnetic fields. Individuals with cardiac pacemakers, implanted defibrillators, other electronic medical devices, metallic prosthetic heart valves, internal wound clips (from surgery), metallic prosthetic devices or sickle cell anemia must not handle or be in the proximity of the magnets contained inside the pump. Consult a health care provider for specific recommendations before working with this pump.

⚠ WARNING: The SP Series are not recommended for pumping flammable or combustible liquids. During the priming process, the pump atmosphere can become very dangerous should the pump fail to prime and overheat.

SP Series pumps can be used to pump non-flammable or non-combustible liquids in a hazardous area. However, it is important to follow these guidelines:

1. You must select the non-sparking (Ns) bronze bump ring option. The non-sparking ring is pressed into the clamp ring or motor adapter and prevents sparking should the motor bearings fail and the outer mag drive assembly runs out of round.
2. You must select an FTI explosion-proof motor or provide your own explosion-proof motor.

⚠ WARNING: Magnetic force hazard. This pump should only be disassembled and assembled using the recommended procedures. The magnetic attraction is powerful enough to rapidly pull the motor end and the wet end together. Do not place fingers between the mating surfaces of the motor and wet ends to avoid injuries. Keep the drive magnet and impeller assembly away from metal chips or particles, items with magnetic stripes like credit cards and magnetic computer media such as floppy discs and hard drives.

⚠ WARNING: Hot surfaces. This pump is capable of handling liquids with temperatures as high as 220° F (104° C). This may cause the outer areas of the pump to become hot as well and could cause burns.

⚠ WARNING: Rotating Parts. This pump has components that rotate while in operation. Follow local safety standards for locking out the motor from the power supply during maintenance or service.

⚠ WARNING: Chemical Hazard. This pump is used for transferring many types of potentially dangerous chemicals. Always wear protective clothing, eye protection and follow standard safety procedures when handling corrosive or personally harmful materials. Proper procedures should be followed for draining and decontaminating the pump before disassembly and inspection of the pump. There may be small quantities of chemicals present during inspection.

⚠ WARNING: Never run pump at less than minimum flow or with the discharge valve closed. This could lead to pump failure.

⚠ WARNING: The pump and associated components are heavy. Failure to properly support the pump during lifting and movement could result in serious injury or damage to the pump and components.

⚠ CAUTION: This pump should never be started without the 2 1/2 gallons (9.5 liters) of priming fluid in the housing. If the pump has a PTFE, ceramic or silicon carbide bushing, IT CANNOT BE RUN DRY WITHOUT CAUSING DAMAGE TO THE PUMP. However, the pump can operate without liquid in the housing if the pump has a carbon bushing. The exact length of time the pump can operate dry with a carbon bushing varies with operating conditions and environment.

CAUTION: Never start or operate with a closed suction valve.

WARNING: Operation without priming or against a closed discharge valve can result in high temperatures that can result in injury or damage to pump components.

CAUTION: Always provide adequate NPSHa (net positive suction head available). It is recommended to provide at least 2 feet (61 cm) above the NPSHr (net positive suction head required).

CAUTION: If pump is used on variable speed drive, do not exceed the frequency for which the pump was designed (for example, if the pump is a 50 Hz model, do not exceed 50 Hz).

SP22 Capabilities

• **Maximum Working Pressure:** 90 psi (6.2 bar)

• **Maximum Temperature:** Polypropylene -180° F (82° C); PVDF – 220° F (104° C)

NOTE: Maximum temperature is application dependent. Consult a chemical resistance guide or the chemical manufacturer for chemical compatibility and temperature limits.

• **Maximum Lift:** 25 feet (7.6 meters)

NOTE: Lift determined on fresh, cold water with 3" Schedule 40 pipe. Specific gravity affects lift capability. Divide 25 feet (7.6 meters) by the specific gravity to determine equivalent maximum lift.

• **Solids:** Maximum particle size is 100 microns for slurries and 1/64" (.4 mm) for occasional solids. Maximum hardness is 80 HS. Maximum concentration is 10% by weight. **If solids are being pumped, it is recommended that the pump have silicon carbide components for best results.** Pumping solids may lead to increased wear.

NOTE: While the pump is capable of being used in sump applications, it is NOT a trash pump. Care must be taken to ensure that debris and foreign objects do not enter the pump or damage may result. FTI recommends using a 2" (50.8 mm) or 3" (76.2 mm) strainer basket with 1/8" (3.2 mm) perforations. Regular strainer basket maintenance is required to prevent plugging and a decrease in NPSHa so not to starve and damage the pump.

• **Minimum Allowable Flow Rate**

Do not allow the flow rate to drop below the minimum flow rate in the chart below:

3450/2900 rpm	1750/1450 rpm
10 US gpm (2.3 m ³ /hr)	5 US gpm (1.1 m ³ /hr)

• **Maximum Allowable Motor Power**

Do not exceed 7.5 kW (10 horsepower) for 50 Hz, 2900 rpm applications. For 60 Hz, 3450 rpm applications, the pump is capable of starting a 15 horsepower motor but is limited to a maximum of 13 horsepower (9.7 kW) while running. Use the information in the chart below to determine the maximum specific gravity capabilities by impeller trim for non-overloading applications. The use of a power monitor is strongly recommended for 60 Hz applications above 10 horsepower (7.5 kW).

• **Maximum Noise Level:** 80 dBA (pump only)

• **Maximum Specific Gravity for Non-Overloading Applications**

3450 rpm (60 Hz)	
Impeller Diameter	Maximum Specific Gravity
7" (177.8 mm)	1.0
6.5" (165.1 mm)	1.3
6" (152.4 mm)	1.6
5.5" (139.7 mm)	1.8
5" (127.0 mm)	1.8

2900 rpm (50 Hz)	
Impeller Diameter	Maximum Specific Gravity
177.8 mm (7")	1.35
165.1 mm (6.5")	1.65
152.4 mm (6")	1.8
139.7 mm (5.5")	1.8
127.0 mm (5")	1.8

- **Priming Liquid Volume**

Initial filling (or refilling after maintenance) of the pump housing requires (2 1/2) US gallons (9.5 liters) of liquid.

- **Priming Time**

Priming time varies with the impeller diameter and speed.

SP22 Priming Time

3450 RPM - 2" Suction Pipe

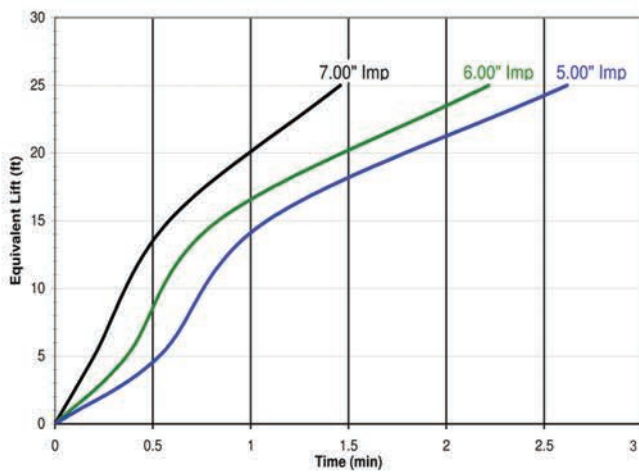

2900 RPM - 2" Suction Pipe

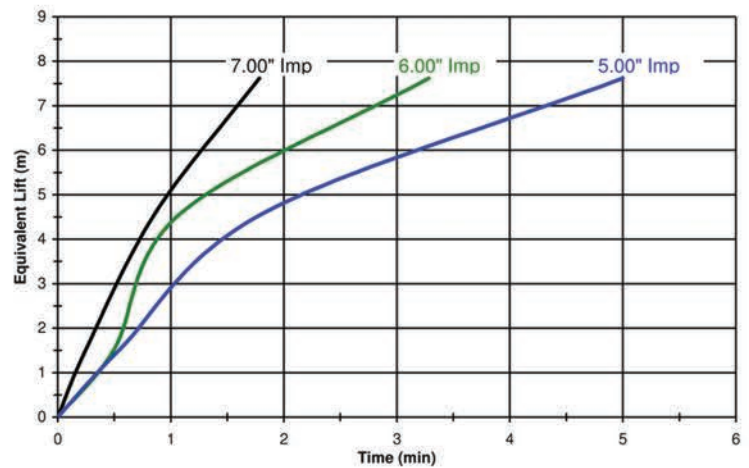

3450 RPM - 3" Suction Pipe

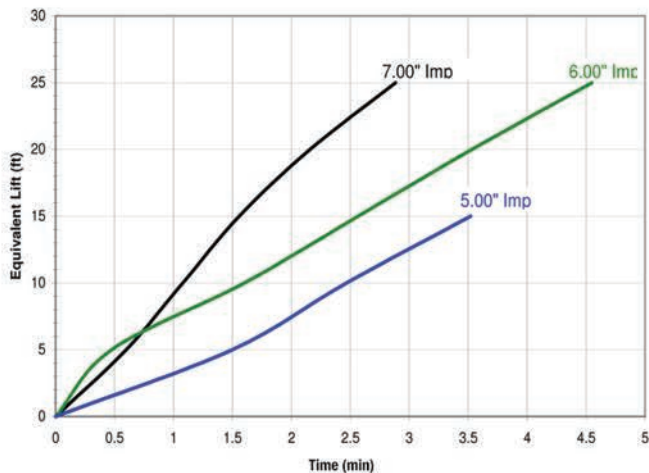

2900 RPM - 3" Suction Pipe

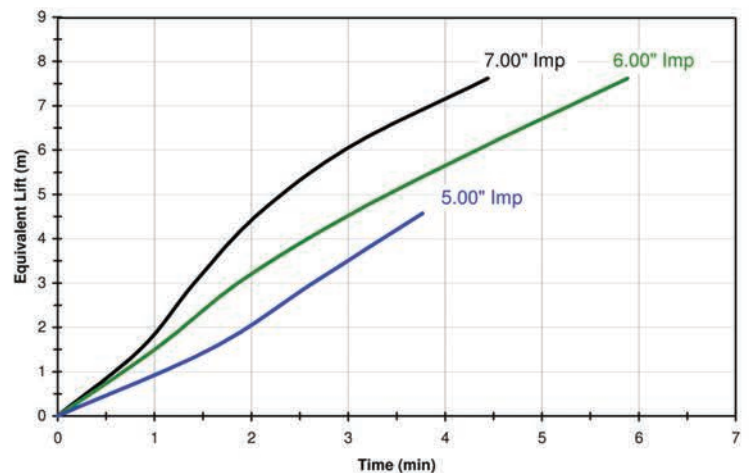

Note: Times shown are guidelines only and may vary depending on system and piping setup
 Recommend using 2" suction pipe with impellers less than 5.50" at equivalent lifts greater than 15' (4.6 m)

SP22 Assembly, Installation and Operation

Unpacking and Inspection

Unpack the pump and examine for any signs of shipping damage. If damage is detected, save the packaging and notify the carrier immediately.

Section I - Assembly



Tools Required:

3/8" Allen wrench or ballpoint hex socket, 3/16" Allen wrench, 10 mm hex socket, metric socket set (for pumps with IEC outer drives)

Pumps with Motors

Proceed to "Installation" Section

Pumps Without Motors

NOTE: All motors must have motor feet.

1. Remove the pump, drive magnet assembly and hardware package from the carton.

CAUTION: Keep away from metallic particles, tools and electronics. Drive magnets **MUST** be free of metal chips.

WARNING: Keep the drive magnet away from the open end of the motor adapter and barrier. Strong magnetic attraction could allow the drive hub to enter the motor adapter resulting in injury or damage.

2. For 184TC motors, proceed to step 3.

For 213/215 NEMA motors only
– Install the o-ring (item 14A) in the groove in the motor adapter. Use small amount of petroleum jelly (or silicone grease on EPDM o-rings) to help hold the o-ring in place. Install the larger female rabet portion of the motor adapter flange (item 14) on the motor face. Align the holes in the adapter with the holes in the motor face. See figure 1.

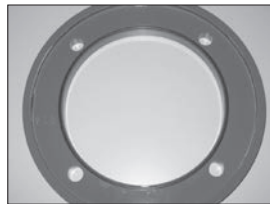

Figure 1

For IEC 90, 100/112, 132 with B5 flange motors - Install flange (item 14) on motor with pockets (depressions) side towards the motor face. Align (4) holes in the adapter with the holes in the motor face. install the (4) customer supplied bolts, lock washers and flat washers through the motor adapter into the motor face. See figure 1.

Flange hole thread size:

90 B5 = M10 x 1.5
100/112 B5 = M12 x 1.75
132 B5 = M12 x 1.75

For 90 & 132 with B14 flange & 145TC motors - Install the flange item 14) on motor with pockets (depressions) side

towards the motor face. Align (4) holes in the adapter with the holes in the motor face. Install (4) bolts, lock washers and flat washers (items 24, 25, 26) through the motor adapter into the motor face. See figure 1.

For 100/112 with B14 flange motors

Install flange (item 10) on motor with pockets (depressions) towards the pump motor adapter (item 8). Align (4) holes in the adapter with the holes in the motor face. Install (4) bolts, lock washers and flat washers (items 20, 21, 22) through the motor adapter into the motor face.

Torque bolts to the following:

90/100/112 B14 frame (M8) = 130 in-lb (14.7 N-m)
132 B14 (M10) frame (M10) = 240 in-lb (27.1 N-m)
90 frame B5 (M10) = 240 in-lb (27.1 N-m)
100/112/132 B5 (M12) = 480 in-lb (54.3 N-m)

3. Coat the motor shaft with anti-seize compound. Insert key supplied with motor into keyway on motor shaft.

NOTE: Make sure the motor shaft is clean and free of burrs. The outer drive is precision machined and has a bore tolerance of +.0005/-0 inch.

4. Slide the outer drive magnet assembly (item 13) onto the motor shaft until the motor shaft contacts the snap ring in the bore of the drive. Figures 2 and 3.

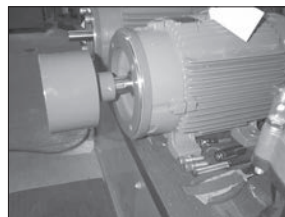

Figure 2



Figure 3

WARNING: Be careful, magnets will try to attract tools.

Metric Motors: Secure the drive to the motor shaft using bolt, lock washer and flat washer (items 21, 22, 23). Thread the bolt into the end of the motor shaft (while holding the outer drive to prevent it from turning). See figure 4.

Tighten the bolt to the following:

· 90 frame (M8) = 130 in-lb (14.7 N-m)
· 100/112 frame (M10) = 240 in-lb (27.1 N-m)
· 132 frame (M12) = 480 in-lb (54.3 N-m)

NEMA Motors: Install set screws (item 13B) into threaded holes on the side of the outer drive magnet assembly. Using a 3/16" Allen wrench, tighten to 228 in-lbs (25.8 N-m). See figure 5.

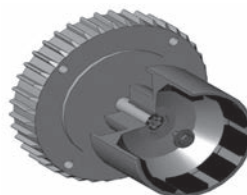

Figure 4



Figure 5

NOTE: The clearance between the motor adapter and drive magnet is tight (about .010"/.254 mm).

5. Install the pump end on the motor/drive magnet assembly.

For 182, 184, 213 and 215TC motor frame pumps, install the o-ring (item 12B) in the groove in the motor adapter (motor end). Use a small amount of petroleum jelly (or silicone grease on EPDM o-rings) to help hold the o-ring in place.

Place the motor/drive on the floor with the drive and motor face pointing up.

Firmly grab the pump and slide over the outer drive magnet until the motor adapter is seated in the rabbet of the motor (184TC) or the motor adapter flange. See figures 6 and 7. The last 4-5" (10-12 cm) will have strong magnetic attraction between the pump and outer drive magnet.

6. Secure the pump to the motor using (4) 1/2" socket head



Figure 6



Figure 7

cap screws, lock washers and flat washers (items 18, 19, 20). Use 3/8" Allen wrench or 3/8" ballpoint hex socket on universal joint. See figures 8 and 9.

7. Rotate the motor fan to ensure that there is no binding in the pump.

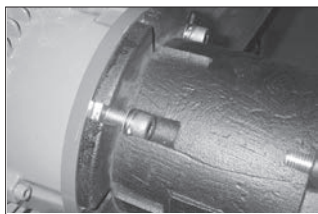

Figure 8

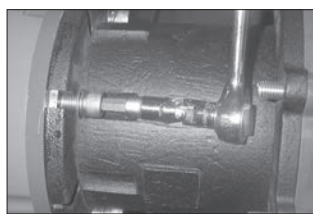

Figure 9

8. Proceed to Installation Section.

Section II - Installation

Mounting – Pump foot should be securely fastened to a solid foundation. If the pump was received with plastic shipping shims, these may be used as additional support for the motor feet.

CAUTION: The NPSH available to the pump must be greater than the NPSH required. The amount of lift, frictional pipe loss and vapor pressure must be calculated into the application. NPSH available should be two feet (.6 meters) greater than NPSH required.

- Total suction lift including pipe friction loss and corrections for specific gravity must not exceed 25 feet (7.6 meters). Contact FTI for pumps installed where the elevation exceeds 1,000 feet (305 meters).

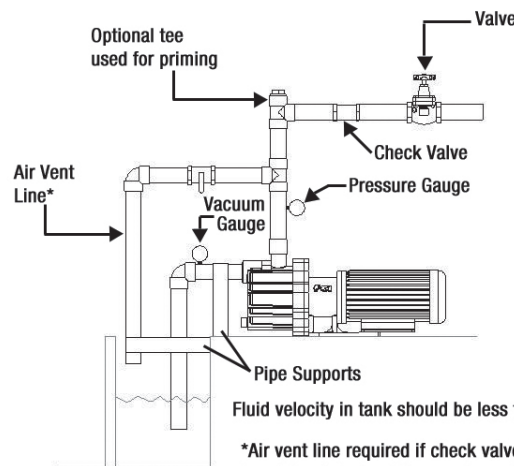

- Install the pump as close to the suction source as possible.
- SP Series pumps are designed to operate in a horizontal position only with discharge on the top.
- SP Series pumps self-priming capability is due to its ability to create a vacuum in the suction piping. **The suction piping MUST be airtight at fittings and connections.**
- Support the piping independently near the pump to eliminate any strain on the pump casing. In addition, the piping should be aligned to avoid placing stress on the pump casing.
- The suction side of the pump should be as straight and short as possible to minimize pipe friction.
- The suction line should not have any high spots. This can create air pockets that can reduce pump performance. The suction piping should be level or slope slightly upward to the pump.
- The suction pipe should be 2" or 3". Larger suction piping will affect priming ability. Smaller piping affects NPSH available and pump performance. See priming curves on page 4 or performance curves in SP Series curve booklet.
- Provide for adequate suction submergence. Excessive submergence will reduce pump performance.
- The end of the pipe should be at least 3" (7.6 cm) above the bottom of the suction tank.
- If debris is in the suction tank, a strainer can be installed to help prevent foreign matter from entering the pump. The

strainer must be periodically cleaned to prevent restriction. Strainer hole size should be 1/8" (1.6 mm) with the amount of open area equal to or greater than 2 times the suction pipe diameter.

- It is recommended that a vacuum/pressure gage be installed in the suction piping.
- For faster priming on installations with high lift, a foot valve is recommended.
- Check and control valves (if used) should be installed on the discharge line. The control valve is used for regulating flow. Isolation valves on the suction and discharge are used to make the pump accessible for maintenance. The check valve helps protect the pump against damage from water hammer. This is particularly important when the static discharge head is high.

NOTE: If a check valve is used in the discharge line, it must be placed at a distance at least equal to the maximum suction lift from the pump. If this cannot be done, an air vent must be provided in the discharge line.

- If flexible hose is preferred over pipe, use a reinforced hose rated for the proper temperature, pressure and is chemically resistant against the fluid being pumped.
- The suction valve must be completely open to avoid restricting the suction flow.
- When installing pumps with flanges, we recommend use of low seating stress gaskets such as Gore-Tex® or Gylon® (expanded PTFE).
- It is advisable to install a flush system in the piping to allow the pump to be flushed before the pump is removed from service.

NOTE: The pump is provided with a 1/2" BSPB drain in the impeller housing.

- A "tee" can be installed in the discharge piping as an alternative location for filling the housing with fluid before pump operation.
- "Filling" is defined as filling the housing with 2 1/2 gallons (9.5 liters) of liquid
- "Priming" is defined as evacuating all the air from the suction piping/pump and replacing it with fluid.

Motor/Electrical

Install the motor according to NEC requirements and local electrical codes. The motor should have an overload protection circuit.

Wire the motor for clockwise rotation when facing the fan end of the motor.

▲ CAUTION: Do not operate the pump to check rotation until the pump is full of liquid.

Check all electrical connections with the wiring diagram on the motor. Make sure the voltage, frequency, phase and amp draw comply with the supply circuit.

To verify correct rotation of the motor:

1. Install the pump into the system.
2. Remove the fill plug and fill the housing with (2 1/2) US gallons (9.5 liters) of the service liquid or water. Replace fill plug and tighten until the o-ring is seated.
3. Fully open the suction and discharge valves.
4. Jog the motor (allow it to run for 1-2 seconds) and observe the rotation of the motor fan. Refer to the directional arrow molded into the front of the housing if necessary.

NOTE: An SP pump running backwards may not prime.

Section III - Start-up and Operation

1. Be sure the housing has been filled with 2 1/2 gallons (9.5 liters) of service liquid and the fill plug has been installed and tightened until the o-ring is seated.
2. Open the inlet (suction) and discharge valves completely.
3. Turn the pump on. Wait for discharge pressure and flow to stabilize (could take several minutes depending upon suction lift). Adjust the flow rate and pressure by regulating the discharge valve. Do not attempt to adjust the flow with the suction valve.

Section IV - Shutdown

Turn off the motor.

NOTE: When the pump is stopped without a check valve in the piping, liquid will flow through the pump returning to the suction source. The SP design allows enough liquid to be retained in the housing to allow repriming without having to refill with liquid.

Flush Systems

▲ CAUTION: Some fluids react with water; use compatible flushing fluid.

1. Turn off the pump.
2. Completely close the suction and discharge valves.
3. Connect flushing fluid supply to flush inlet valve.
4. Connect flushing fluid drain to flush drain valve.
5. Open flushing inlet and outlet valves. Flush system until the pump is clean.

NOTE: The drain can be used as the flushing drain valve using appropriate customer supplied fittings. Using the drain helps to promote superior flushing and draining results.

Maintenance

Recommended maintenance schedule

The recommended maintenance schedule depends upon the nature of the fluid being pumped and the specific application. If the pump is used on a clean fluid, it is recommended that the pump be removed from service and examined after six months of operation or after 2,000 hours of operation. If the pump is used on fluids with solids, high temperatures or other items that could cause accelerated wear this initial examination should be sooner.

After the initial examination of the internal components and wear items are measured, a specific maintenance schedule can be determined. For best results, it is recommended that the pump be removed from service annually for examination.

Section V - Disassembly

Tools Required:

3/8" Allen wrench or ballpoint hex socket, 3/16" Allen wrench, (2) flat head screw drivers, 10 mm hex socket, metric socket set (for pumps with IEC outer drives).

⚠ WARNING: Rotating Parts. This pump has components that rotate while in operation. Follow local safety standards for locking out the motor from the power supply during maintenance or service.

⚠ WARNING: Chemical Hazard. This pump is used for transferring many types of potentially dangerous chemicals. Always wear protective clothing, eye protection and follow standard safety procedures when handling corrosive or personally harmful materials. Proper procedures should be followed for draining and decontaminating the pump before disassembly and inspection of the pump. There may be small quantities of chemicals present during inspection.

⚠ WARNING: Magnetic force hazard. This pump should only be disassembled and assembled using the recommended procedures. The magnetic attraction is powerful enough to rapidly pull the motor end and the wet end together. Do not place fingers between the mating surfaces of the motor and wet ends to avoid injuries. Keep the drive magnet and impeller assembly away from metal chips or particles.

1. Stop the pump, lock out the motor starter, close all the valves that are connected to the pump, and drain/decontaminate the pump.

⚠ WARNING: The pump must be thoroughly flushed of any hazardous materials and all internal pressure relieved prior to opening the pump. Allow the pump to reach ambient temperatures prior to performing maintenance.

2. Place the pump/motor on the floor with the pump facing up. Remove (4) 1/2" socket head cap screws, lock washers and flat washers (items 18, 19,

20) securing the pump to the motor. Use 3/8" Allen wrench or 3/8" hex socket on universal joint.

3. Firmly grab the motor adapter and pull straight up to disengage the motor and pump. See figure 10.



Figure 10

For 182, 184, 213, and 215TC motor frame pumps, make sure the o-ring (item 12B) does not fall out of the motor adapter (motor end).

4. Place pump on bench with housing (item 1) facing up. Using a 10 mm hex (Allen) wrench, remove (10) M12 socket head cap screws, lock washers and flat washers (items 15, 16, 17). See figure 11.

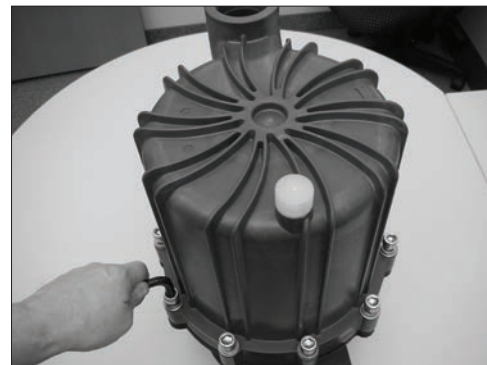
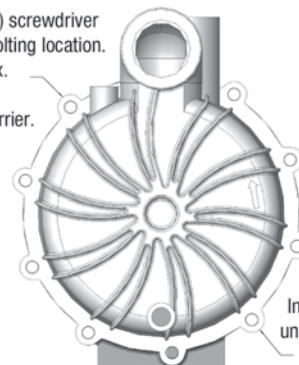

Figure 11

Remove the housing (item 1) by carefully inserting two flat head screwdrivers at the locations shown in Figure 12. Slide the screwdrivers in at the bolt holes between the metal motor adapter and the housing until they stop.

Insert one (1) screwdriver under this bolting location. Insert approx. 1-1/4" until it hits the barrier.



Insert one (1) screwdriver under this bolting location. Insert approx. 1-1/4" until it hits the barrier.

Figure 12

Applying equal pressure, gently pry both screwdrivers in upward motion away from the table (to avoid damaging sealing surface). See figure 12A. Housing is tight due to o-ring seal on the internal “gooseneck”.

NOTE: Do not twist the screwdrivers or damage may occur to the housing.

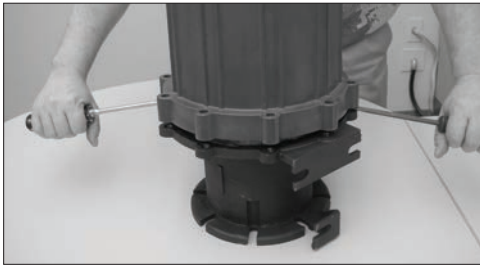

Figure 12A

5. Examine the housing for signs of wear or damage. Inspect the gooseneck and suction and discharge for cracks. See figure 13. Inspect fill and drain plug o-rings (item 2A) for chemical attack, swelling, brittleness, cuts, etc.



Figure 13



Figure 14

6. Carefully remove the inner volute o-ring (item 4). See figure 14. Inspect for chemical attack, swelling, brittleness, cuts, etc.
7. Pull the separator plate (item 5) off the inner volute (item 6). Inspect for damage and cracks.
8. To remove the inner volute (item 6), pull back on the (3) snap fit prongs one at a time so that the hook portion falls into the channel on the inner volute. See figures 15 and 16.

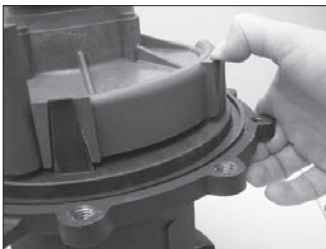

Figure 15



Figure 16

9. Pull the inner volute straight off. Be careful since the impeller shaft may come out with the inner volute. See figure 17.
10. Remove impeller/inner drive assembly (items 7A, 7, 8, 8A). Inspect for signs of rubbing, damage and wear. See figure 18. Check the impeller thrust ring and bushing for wear. See figure 19.
11. Remove the impeller shaft (item 9) from the barrier and check for signs of cracking, chipping, scoring or wear. See figure 20.

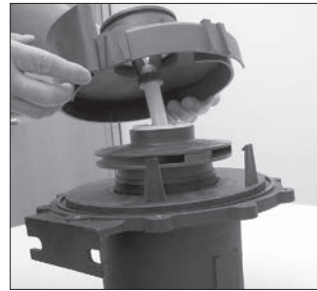

Figure 17

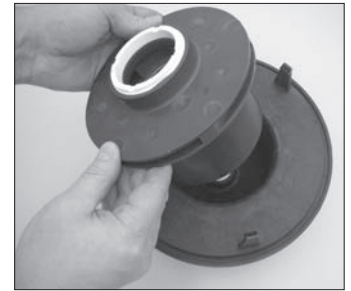

Figure 18

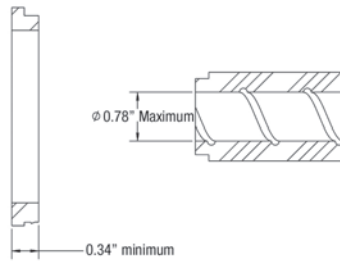

Figure 19

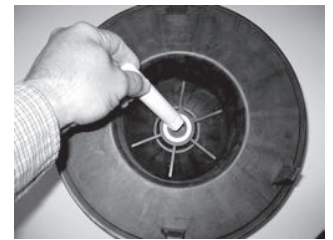

Figure 20

12. Remove the barrier (item 11) from the motor adapter (item 12) (make sure the impeller shaft has been removed). If necessary, gently tap on the backside of the barrier with a soft rod (wood, plastic, etc). Inspect the inside and outside of the barrier for signs of rubbing. See figure 21.

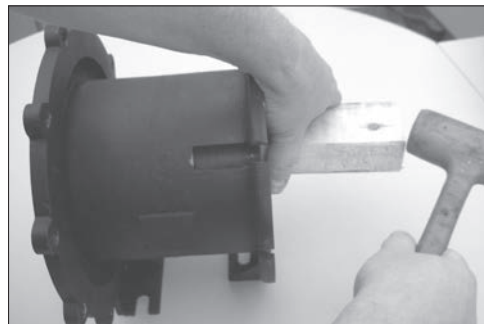

Figure 21

- Remove the o-ring (item 10) from the barrier and inspect for chemical attack, swelling, brittleness, cuts, etc.
- Visually inspect the outer drive (item 13) for rubbing, damage, corrosion or loose magnets.

For 182, 184, 213 and 215TC frame pumps only, inspect the o-rings (item 12A, 12B and 14A if applicable) for chemical attack, swelling, brittleness, cuts, etc.

Outer Drive Replacement

- Remove the setscrews (item 13B) from the side of the drive (NEMA motors) or the bolt, lock washer and flat washer (items 21, 22, 23) from the center of the drive (metric motors).

⚠ WARNING: Be careful, tools will want to be attracted to the magnets.

- Remove the drive magnet from the motor shaft by gently prying up from the bottom of the drive. See figure 22.
- To reinstall the drive or a new drive follow the instructions from Section I – Assembly, Pumps without Motors, steps 3 & 4.



Figure 22

Impeller Thrust Ring

The impeller thrust ring is located in the front of the impeller shroud and is held in place with a snap-fit ridge.

Removal

- Using a razor knife or side cutters, cut a notch out of the thrust ring. Pull up and out of the holder. See figures 23 and 24.

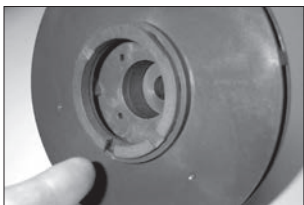

Figure 23

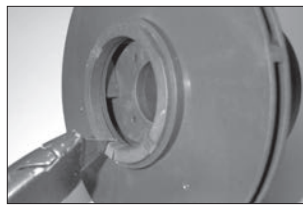

Figure 24

NOTE: A new impeller thrust ring will be required after removal.

Replacement

- Place the impeller and impeller drive assembly (items 7, 7A, 8 & 8A) on a table with the eye of the impeller facing up.
- Position the replacement impeller thrust ring in the bore of the front shroud with the snap fit ridge towards the bottom of the bore. Align the anti-rotation flat on the impeller thrust ring with the flat in the impeller shroud.
- Place the impeller and impeller drive assembly in an arbor press. Using a soft faced arbor, gently press the impeller thrust ring into place.

Impeller Bushing

Removal

- To remove the bushing, place the impeller/inner drive assembly (items 7, 7A, 8 & 8A) with the impeller facing up in an arbor press. If necessary support the bottom of the assembly with blocks to allow the bushing to fall out. Insert a 1" (25.4 mm) diameter plastic or wooden shaft through the impeller and press bushing out. See figure 25.
- To replace bushing, place the assembly on a flat surface with the impeller thrust ring face down. With the slotted face of the bushing facing the rear of the inner drive, align the flat in the bushing with the flat in the inner drive magnet. See figure 26. Gently push until bushing bottoms out.

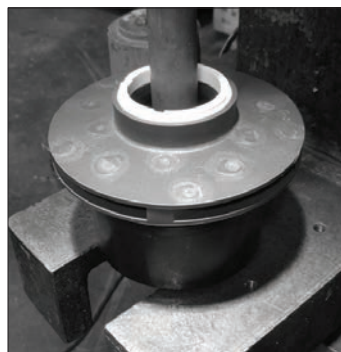

Figure 25



Figure 26

Impeller Disassembly

To separate impeller (item 7A, 7) from the inner drive (item 8A, 8), use two flat head screwdrivers in slots provided to gently pry apart.

Reassembly

- Install impeller shaft (item 9) into barrier (item 11) by aligning the flats on the shaft with the ones in the barrier. Make sure it is completely seated. See figure 27.
- Carefully install the impeller/inner drive assembly (items 7A, 7, 8, 8A) by sliding it over the impeller shaft in the barrier. See figure 28.
- Install the inner volute (item 6) by lining up the prongs of the barrier with the channels in the inner volute. Press down



Figure 27



Figure 28

evenly until the prongs snap onto the surface of the inner volute. See figure 29.

⚠ WARNING: Magnetic force hazard. Keep fingers away from mating surfaces.

4. Install barrier, inner volute, impeller/inner drive and impeller shaft assembly into the motor adapter (item 12). Line up the center of the inner volute bottom port with the center of the motor adapter foot. See Figure 30.

NOTE: If the pump has the o-ring sealing option (available on 184 and 215 frame pumps only), install the o-ring (item

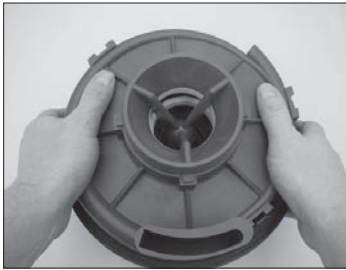

Figure 29

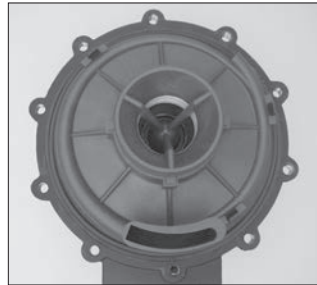

Figure 30

12A) in the groove in the motor adapter before installing the barrier, inner volute, impeller/inner drive and impeller shaft. Barrier will have to be pushed into place with o-ring sealing option.

NOTE: Bolts are not on center line.

5. Install o-ring (item 10) in groove in barrier. Make sure o-ring is properly seated.
6. Install the separator plate (item 5) by lining up the bottom opening of the inner volute with the opening in the plate. Line up the slots in the separator plate with the notches in the inner volute. See figure 31.
7. Lubricate the inner volute o-ring (item 4) with a chemically compatible lubricant and install in the groove on the round suction nozzle in the center of the inner volute. See figure 32.

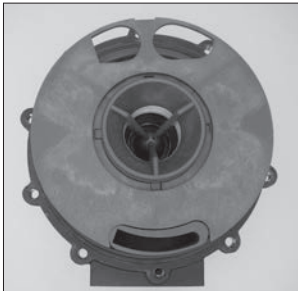

Figure 31

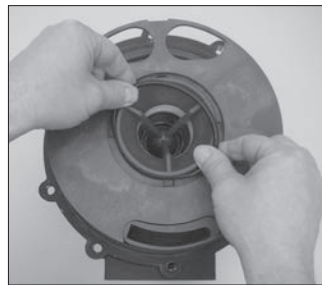

Figure 32

8. Install the housing (item 1). Lubricate the inside of the gooseneck with a chemically compatible lubricant. See figure 35. Line up the notch on the top of the separator plate with the tab in the housing (located inside the front of the housing near the discharge port). See figure 33.



Figure 35



Figure 33



Figure 34

Using uniform pressure, press the housing into place until it is flush with the motor adapter. Rotate the housing if necessary to line up the bolt holes in the housing with the bolt holes in the motor adapter. Tap lightly with a soft mallet if necessary. See figure 34. Install the housing bolts, lock washers and flat washers (items 15, 16, 17).

9. Tighten all bolts evenly using a star pattern. Tighten to 240 in-lbs (27.1 N-m).
10. Reinstall the pump on the motor/drive magnet following instructions found in "Assembly, Pumps without motors," steps 5-8.

SP22 PART NUMBER EXPLANATION

NOTE: Pump end includes wetted components, drive magnet and motor adapter. The wet end includes wetted components only.

Part Number Explanation

The base model number contains standard components. Where standard components are not suitable, add the alternative component code letter after the base model number to substitute components. Example: SP22P-E-U-21 is constructed of the listed base model components except it has an EPDM O-ring, union connections, and a 213TC motor adapter.

The model number is on the serial number label located on the motor adapter. The model number contains a base model that features certain standard components. Compare the model number on the pump to the adjacent chart to determine if the pump contains any alternate components. Model numbers containing "P" have primary components molded from polypropylene. Model numbers contain "V" have primary components molded from PVDF.

Base model numbers are: SP22P, SP22V

Alternative Components Price Adders										
Component	Base		Alternative						Code	
Bushing	Carbon	or	PTFE						T	
O-ring	Viton	or	EPDM						E	
Connection	NPT	or	BSP						B	
			Union						U	
			Steel Enforced Flange						Fs	
			2" x 2" FRP flange						Ff	
			3" x 2" FRP flange						3 x 2	
Impeller	1 (60 Hz) 7"	or	1A	1B	1C	2	2A	2B	2C	3
			6.88"	6.75"	6.63"	6.50"	6.38"	6.25"	6.13"	6.00"
			3A	3B	3C	4	4A	4B	4C	5
			5.88"	5.75"	5.63"	5.50"	5.38"	5.25"	5.13"	5.00"
Magnet (Upgrade for specific gravity correc- tions)	8-pole Up to 13 HP (60 Hz) / 7.5 kW (50 Hz)	or	No Upgrade Available.							
Motor Adaptor	182-184TC NEMA	or	145TC NEMA						145	
			213-215TC NEMA						21	
			IEC 90/B14						94	
			IEC 100/B14						04	
			IEC 112/B14						24	
			IEC 132/B14						34	
			IEC 90/B5						95	
			IEC 100/B5						05	
			IEC 112/B5						25	
			IEC 132/B5						35	
Gas engine mounting						Ge				
Specials	Not Standard		SiC bushing/shaft						Ss	
			SiC bushing/impeller thrust ring/shaft						Si	
			Hastelloy shaft						Hs	
			Titanium Hardware						Tl	
			Non-sparking ring						Ns	
			O-ring vapor protection kit FKM (NEMA)						Vv	
			O-ring vapor protection kit EPDM (NEMA)						Ve	
Motor	Not Standard		Select Motor Reference Number from Motor Price Sheets							

SP22 PARTS DIAGRAM

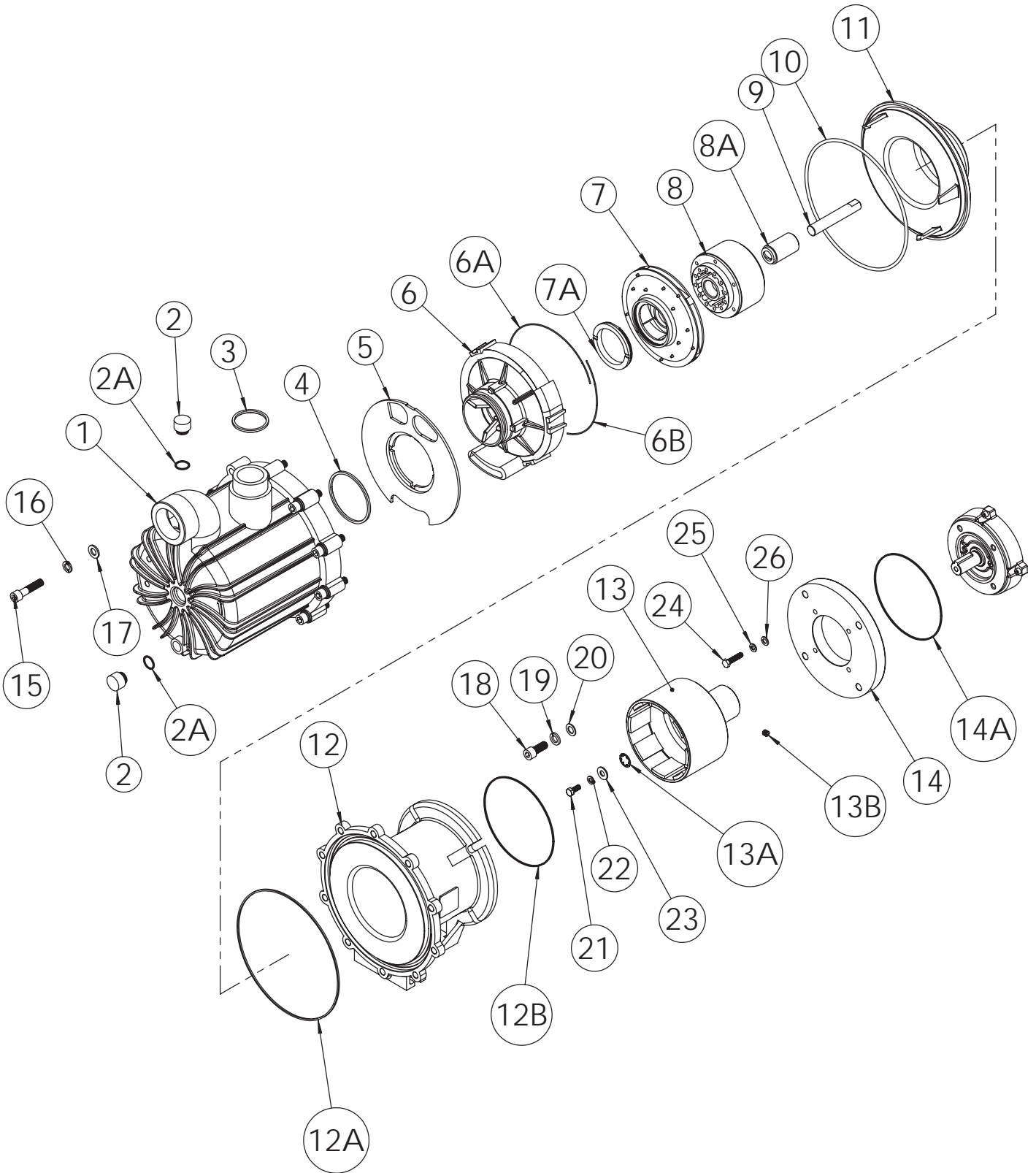

SP22 Spare Parts List

Item	Qty	Description	Polypropylene	PVDF
1	1	Housing		
		NPT threads	106437	106437-1
		BSP threads	106437-2	106437-3
		Fiberglass flanges 2" x 2"	106750	106750-1
		Fiberglass flanges 3" x 2"	107115-2	107115-3
		Steel flanges 2" x 2"	106750-2	106750-3
		Unions	106749	106749-1
2	2	Fill/Drain Plug		
			106143	106143-1
2A	2	Fill/Drain Plug O-Ring		
		FKM		106155
		EPDM		106154
3	1	Discharge O-ring (BSP Housings Only)		
		FKM		105083
		EPDM		105084
4	1	Inner Volute O-Ring		
		FKM		106770
		EPDM		106771
5	1	Separator Plate		
			106438	106438-1
6	1	Inner Volute w/ SiC Thrust Ring & Volute/Barrier Seal (Inner Volute matches impeller trim)		
		#1 impeller (7.00") w/ FKM seal	107459	107459-1
		#1A impeller (6.88") w/ FKM seal	107459-8	107459-9
		#1B impeller (6.75") w/ FKM seal	107459-10	107459-11
		#1C impeller (6.63") w/ FKM seal	107459-12	107459-13
		#2 impeller (6.50") w/ FKM seal	107459-2	107459-3
		#2A impeller (6.38") w/ FKM seal	107459-14	107459-15
		#2B impeller (6.25") w/ FKM seal	107459-16	107459-17
		#2C impeller (6.13") w/ FKM seal	107459-18	107459-19
		#3 impeller (6.00") w/ FKM seal	107459-4	107459-5
		#3A impeller (5.88") w/ FKM seal	107459-20	107459-21
		#3B impeller (5.75") w/ FKM seal	107459-22	107459-23
		#3C impeller (5.63") w/ FKM seal	107459-24	107459-25
		#4 impeller (5.50") w/ FKM seal	107459-6	107459-7
		#4A impeller (5.38") w/ FKM seal	107459-26	107459-27
		#4B impeller (5.25") w/ FKM seal	107459-28	107459-29
		#4C impeller (5.13") w/ FKM seal	107459-30	107459-31
		#5 impeller (5.00") w/ FKM seal	107459-32	107459-33
		#1 impeller (7.00") w/ EPDM seal	107462	107462-1
		#1A impeller (6.88") w/ EPDM seal	107462-8	107462-9
		#1B impeller (6.75") w/ EPDM seal	107462-10	107462-11
		#1C impeller (6.63") w/ EPDM seal	107462-12	107462-13
		#2 impeller (6.50") w/ EPDM seal	107462-2	107462-3
		#2A impeller (6.38") w/ EPDM seal	107462-14	107462-15
		#2B impeller (6.25") w/ EPDM seal	107462-16	107462-17
		#2C impeller (6.13") w/ EPDM seal	107462-18	107462-19
		#3 impeller (6.00") w/ EPDM seal	107462-4	107462-5
		#3A impeller (5.88") w/ EPDM seal	107462-20	107462-21
		#3B impeller (5.75") w/ EPDM seal	107462-22	107462-23
		#3C impeller (5.63") w/ EPDM seal	107462-24	107462-25
		#4 impeller (5.50") w/ EPDM seal	107462-6	107462-7
		#4A impeller (5.38") w/ EPDM seal	107462-26	107462-27
		#4B impeller (5.25") w/ EPDM seal	107462-28	107462-29
#4C impeller (5.13") w/ EPDM seal	107462-30	107459-31		
#5 impeller (5.00") w/ EPDM seal	107462-32	107462-33		

SP22 Spare Parts - continued

Item	Qty	Description	Polypropylene	PVDF
6A	1	Volute / Barrier Seal - 16-1/8" length		
		FKM	107458	
		EPDM	107458-1	
6B	1	Volute / Barrier Seal - 8" length		
		FKM	107457	
		EPDM	107457-1	
7	1	Impeller Assembly with Thrust Ring <i>See SP22 Impeller Assemblies Table</i>		
7A	1	SP22 Closed Impeller Thrust Ring Only		
		Fluorosint	106950	
		SiC	106951	
8	1	Impeller Drive Assembly		
		With carbon bushing	106476	106476-1
		With PTFE bushing	106476-2	106476-3
		With ceramic bushing	106476-6	106476-7
		With silicon carbide bushing	106476-4	106476-5
8A	1	Impeller Bushing Only		
		Carbon	J103917-1	
		Filled PTFE	106757	
		Ceramic	106757-2	
		SiC	106757-1	
9	1	Impeller Shaft		
		Ceramic	106450	
		SiC	106450-1	
		Hastelloy C	106450-2	
10	1	Housing O-ring		
		EPDM	106765	
		FKM	106764	
11	1	Barrier		
			106400-2	106400-3
12	1	Motor Adapter		
			106414-1	106414-2
12A	1	Front Motor Adapter O-Ring		
		Buna Std.	106844	
		EPDM	106845	
		FKM	106846	
12B	1	Rear Motor Adapter O-Ring		
		Buna Std.	106847	
		EPDM	106848	
		FKM	106849	
13	1	Outer Drive Magnet Assembly with Retaining Ring		
		143/145TC frame (includes set screws)	106457-3	
		182/184TC frame (includes set screws)	106453	
		213/215TC frame (includes set screws)	106453-1	
		90 frame	106457	
		100/112 frame	106457-1	
		132 frame	106457-2	
13A	1	Retaining Ring Only		
		145TC frame	105709	
		184TC frame	105710	
		213TC frame	106454	
		90 frame	105712	
		100/112 frame	105710	
		132 frame	106468	

Item	Qty	Description	Polypropylene	PVDF
13B	2	Set Screws		
		NEMA frames only		J101084
14	1	Motor Adapter Flange		
		213/215TC	106775	106775-1
		90 B14	106781	106781-1
		90 B5	106780	106780-1
		100/112 B14 & 143/145TC	106777	106777-1
		100/112 B5	106776	106776-1
		132 B14	106779	106779-1
14A	1	Motor Adapter Flange O-Ring (NEMA 213/215 Frame Motors Only)		
		Buna		108165
		EPDM		108166
		FKM		108167

HARDWARE - ALL SP22 MODELS

Item	Qty	Description	Stainless Steel	Titanium
15	10	Housing Bolt		
			106758	106759
16	10	Housing Lock Washer		
			106503	106504
17	10	Housing Flat Washer		
			106505	106506
18	4	Motor Adapter Bolt		
		All available frame sizes except 213/215TC	106495	106498
		213/215 TC	106511	106512
19	4	Motor Adapter Lockwasher		
			J101023	106499
20	4	Motor Adapter Flatwasher		
			106497	106500
21	1	Drive Bolt (IEC Only)		
		90 frame	105770	105771
		100/112 frame	105774	105775
		132 frame	106507	106508
22	1	Drive Lockwasher (IEC Only)		
		90 frame	J102282	J103847
		100/112 frame	105757	105758
23	1	Drive Flatwasher (IEC Only)		
		90 frame	105722	105772
		100/112 frame	J101360	106200
24*	4	Motor Adapter Flange Bolt (for IEC with B14 flange and 143/145TC Frames Only)		
		90 Frame	108029	106513
		100/112 Frame	105589	106514
		132 Frame	105774	105775
25*	4	Motor Adapter Lock Washer (for IEC with B14 flange only)		
		90 Frame	J102282	J103847
		100/112 Frame	J102282	J103847
		132 Frame	105757	105758
26*	4	Motor Adapter Flat Washer (for IEC with B14 flange only)		
		90 Frame	J101293	J103845
		100/112 Frame	J101293	J103845
		132 Frame	N/A	N/A

*Customer must supply motor adapter flange bolt, lock washer and flat washer for IEC frame motors with B5 flanges

SP22 Impeller Assemblies

Thrust Ring	Impeller Material	#1	#1A	#1B	#1C	#2	#2A	#2B	#2C	#3	#3A
		7.00"	6.88"	6.75"	6.63"	6.50"	6.38"	6.25"	6.13"	6.00"	5.88"
PTFE	Polypro	106746	106746-10	106746-12	106746-14	106746-2	106746-16	106746-18	106746-20	106746-4	106746-22
	PVDF	106746-1	106746-11	106746-13	106746-15	106746-3	106746-17	106746-19	106746-21	106746-5	106746-23
SiC	Polypro	106747	106747-10	106747-12	106747-14	106747-2	106747-16	106747-18	106747-20	106747-4	106747-22
	PVDF	106747-1	106747-11	106747-13	106747-15	106747-3	106747-17	106747-19	106747-21	106747-5	106747-23
Thrust Ring	Impeller Material	#3B	#3C	#4	#4A	#4B	#4C	5	-	-	-
		5.75"	5.63"	5.50"	5.38"	5.25"	5.13"	5.00"	-	-	-
PTFE	Polypro	106746-24	106746-26	106746-6	106746-28	106746-30	106746-32	106746-8	-	-	-
	PVDF	106746-25	106746-27	106746-7	106746-29	106746-31	106746-33	106746-9	-	-	-
SiC	Polypro	106747-24	106747-26	106747-6	106747-28	106747-30	106747-32	106747-8	-	-	-
	PVDF	106747-25	106747-27	106747-7	106747-29	106747-31	106747-33	106747-9	-	-	-

All impeller diameters listed in inches.

Section VI - Troubleshooting

General Notes:

- Cold water will contain dissolved air. Under high lift applications, the air can come out of solution blocking suction passages. This can lead to lack of priming, slow priming or low flow rates.
- Do not pump liquids containing ferrous metal fines.
- If magnets decouple, stop pump immediately. Operating the pump with the magnets decoupled will eventually weaken the magnets.
- Contact our Technical Service Department at 1-800-888-3743 or by e-mail at techservice@finishthompson.com if you have any questions regarding product operation or repair.

No or Insufficient Discharge

- Air leaks in suction piping
- Housing not filled with priming fluid
- Suction pipe smaller than 3 inches
- Suction pipe contains high spots causing trapped air pockets
- Suction pipe excessively long (flow drops as suction pipe gets longer)
- System head higher than anticipated
- Closed valve
- Viscosity or specific gravity too high
- Motor too large for magnet coupling rating (magnets uncoupled)
- Suction lift too high or insufficient NPSH
- Clogged suction line, suction strainer (if used) or impeller vanes

Insufficient Pressure

- Air or gas entrained liquid
- Impeller diameter too small
- System head lower than anticipated
- Motors speed insufficient (too low) or motor rotation incorrect (correct rotation when viewed from the fan end is clockwise)

Won't Prime

- Did not fill housing with fluid before initially starting pump
- Closed discharge valve (valve should be open or open air vent line)
- Leak in suction piping
- Suction pipe not submerged enough (causing a vortex or exposing the end of the suction pipe)
- Lift exceeds pump ability (see Capabilities section)
- Suction pipe diameter too large
- Specific gravity or local atmospheric pressure (altitude/elevation) not accounted for in lift calculations
- Mismatch of inner volute and impeller diameter
- Inner volute o-ring chemically attacked, cut, brittle, etc.

- Motor rotation incorrect (correct rotation when viewed from the fan end is clockwise)
- Check valve installed too close to the pump.

Primes Slowly

- Mismatch of inner volute and impeller diameter
- Suction pipe diameter too large (larger than 3 inches)
- Closed discharge valve (valve should be open)
- Inner volute o-ring chemically attacked, cut, brittle, etc.

Excessive Power Consumption

- Head lower than rating
- Excessive flow
- Specific gravity or viscosity too high.

Vibration/Noise

- Loose magnet
- Drive magnet rubbing
- Pump cavitating from improper suction or feed
- Motor or piping not properly secured
- Foreign object in impeller

Section VII - Warranty

Finish Thompson, Inc (manufacturer) warrants this pump product to be free of defects in materials and workmanship for a period of five years from date of purchase by original purchaser. If a warranted defect, which is determined by manufacturer's inspection, occurs within this period, it will be repaired or replaced at the manufacturer's option, provided (1) the product is submitted with proof of purchase date and (2) transportation charges are prepaid to the manufacturer. Liability under this warranty is expressly limited to repairing or replacing the product or parts thereof and is in lieu of any other warranties, either expressed or implied. This warranty does apply only to normal wear of the product or components. This warranty does not apply to products or parts broken due to, in whole or in part, accident, overload, abuse, chemical attack, tampering, or alteration. The warranty does not apply to any other equipment used or purchased in combination with this product. The manufacturer accepts no responsibility for product damage or personal injuries sustained when the product is modified in any way. If this warranty does not apply, the purchaser shall bear all cost for labor, material and transportation.

Manufacturer shall not be liable for incidental or consequential damages including, but not limited to process down time, transportation costs, costs associated with replacement or substitution products, labor costs, product installation or removal costs, or loss of profit. In any and all events, manufacturer's liability shall not exceed the purchase price of the product and/or accessories.

Ordering Spare Parts

Spare parts can be ordered from your local distributor. Always refer to the pump model to avoid error.



FINISH THOMPSON INC.

921 Greengarden Road • Erie, PA 16501-1591 U.S.A.
Ph 814-455-4478 • Fax 814-455-8518
Email fti@finishthompson.com • www.finishthompson.com

Tech Service 1-800-888-3743
Literature ID No. FT08-1024G
Part Number 106783, R13, 6-4-13

