

MSV1 Multistage Pumps

- **304 Series Stainless Steel Components with Teflon® Wear Rings**
- **Cast Iron Base & Adapter**
- **1" NPT Cast Iron Flanges**
- **NEMA 56C Dual Cycle 50/60 Hz, Single or Three Phase TEFC Motors**
- **EPDM/Tungsten Carbide Seal with Easy Replacement Feature**
- **Optional ANSI/ASME 250# Flange Kit**
- **Models Available in 2 thru 27 Stages**

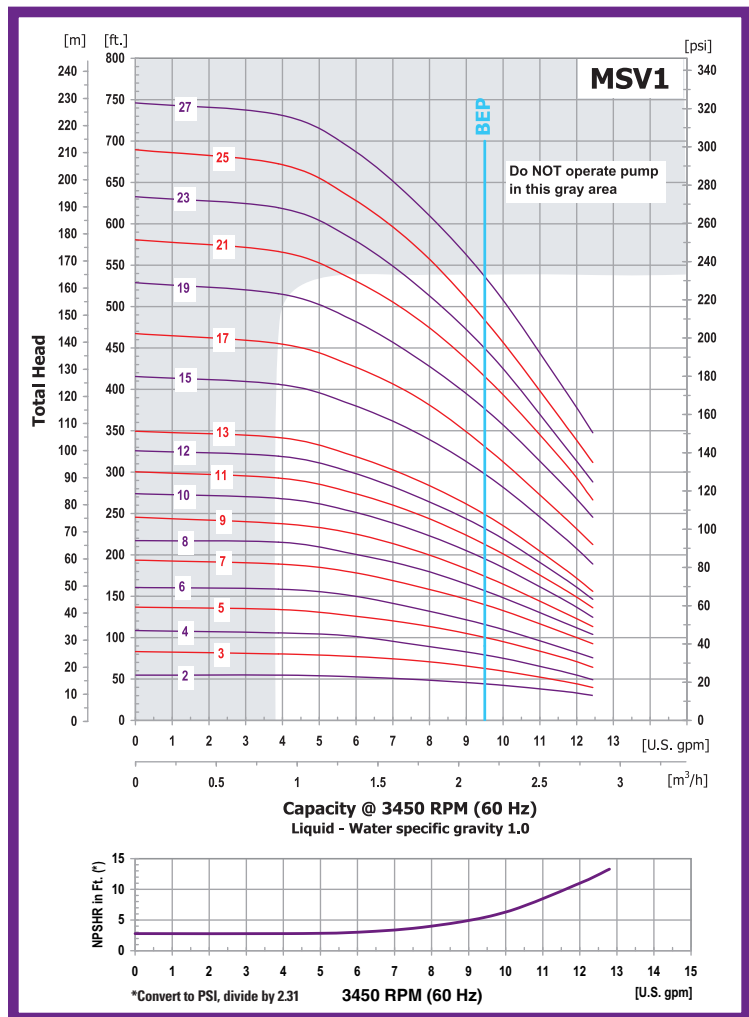

These AMT commercial/industrial centrifugal pumps are non-self-priming (gravity feed) units designed to handle high-pressure low flow liquid transfer applications where no suction lift is required. Typical installations include: hot and chilled water, boiler feed, condensate return, irrigation, high pressure washdown, booster service, and fire protection/sprinkler systems—often referred to as a Jockey Pump. These pumps have NOT been investigated for use in potable (drinking) water systems.



Maximum Working Pressure 232 PSI [1600 kPa]

Maximum Temp 180° F



400 Spring Street • Royersford, PA 19468 USA

www.amtpump.com • 888-amt-pump (268-7867)

For use with nonflammable liquids compatible with pump component materials. Viton® and Teflon® are registered trademarks of E. I. DuPont.

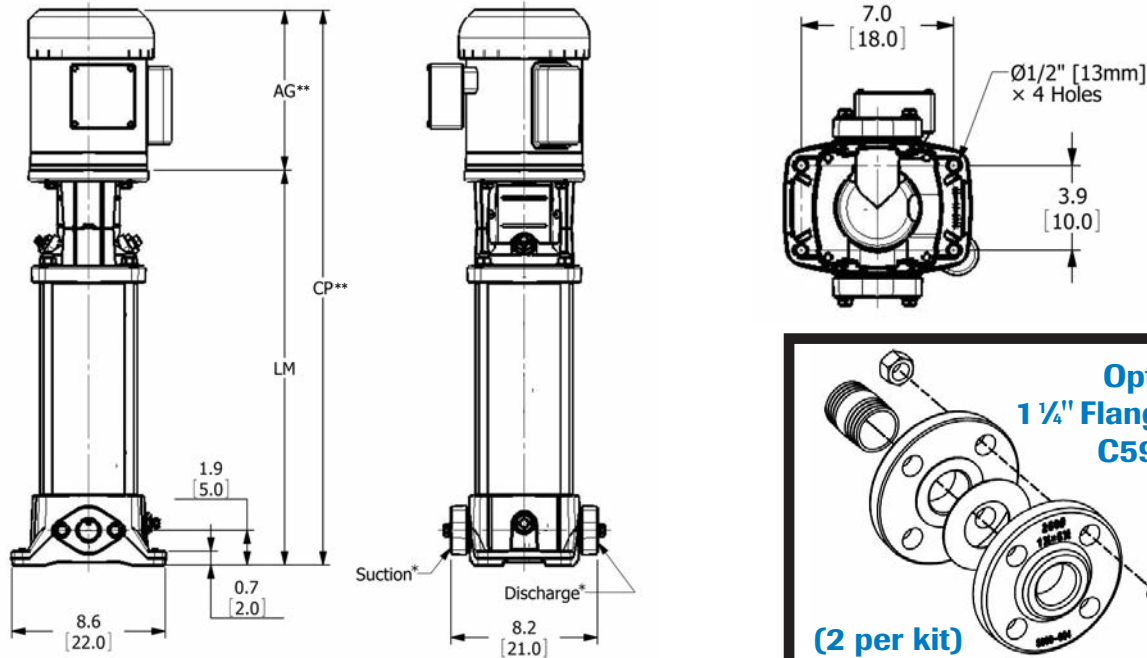

Pumps are interchangeable with Grundfos CR1 Series

SPECIFICATIONS AND DIMENSIONS

*1" NPT (Female) Suction & Discharge Ports

MODEL ▲	STAGES	HP	AG**	LM	CP**	Ship Wt.	
						1 PHASE (-1P)	3 PHASE (-3P)
MSV1-2	2	3/4	9.0 [23.0]	10.9 [27.9]	20.0 [50.8]	59 lbs. [27 kgs.]	56 lbs. [25 kgs.]
MSV1-3	3	3/4	9.0 [23.0]	10.9 [27.9]	20.0 [50.8]	60 lbs. [27 kgs.]	57 lbs. [26 kgs.]
MSV1-4	4	3/4	9.0 [23.0]	11.6 [29.7]	20.7 [52.6]	61 lbs. [28 kgs.]	57 lbs. [26 kgs.]
MSV1-5	5	3/4	9.0 [23.0]	12.3 [31.5]	21.4 [54.4]	62 lbs. [28 kgs.]	58 lbs. [26 kgs.]
MSV1-6	6	3/4	9.0 [23.0]	13.0 [33.3]	22.1 [56.2]	68 lbs. [31 kgs.]	60 lbs. [27 kgs.]
MSV1-7	7	3/4	9.0 [23.0]	13.8 [35.1]	22.8 [58.0]	69 lbs. [31 kgs.]	61 lbs. [28 kgs.]
MSV1-8	8	1	10.2 [26.0]	14.5 [36.9]	24.7 [62.8]	70 lbs. [32 kgs.]	66 lbs. [30 kgs.]
MSV1-9	9	1	10.2 [26.0]	15.2 [38.7]	25.4 [64.6]	71 lbs. [32 kgs.]	67 lbs. [30 kgs.]
MSV1-10	10	1	10.2 [26.0]	15.9 [40.5]	26.1 [66.4]	72 lbs. [33 kgs.]	68 lbs. [31 kgs.]
MSV1-11	11	1½	10.2 [26.0]	16.6 [42.3]	26.8 [68.2]	77 lbs. [35 kgs.]	72 lbs. [33 kgs.]
MSV1-12	12	1½	10.2 [26.0]	17.3 [44.1]	27.5 [70.0]	78 lbs. [35 kgs.]	72 lbs. [33 kgs.]
MSV1-13	13	1½	10.2 [26.0]	18.0 [45.9]	28.2 [71.8]	79 lbs. [36 kgs.]	73 lbs. [33 kgs.]
MSV1-15	15	2	11.4 [29.0]	19.4 [49.5]	30.8 [78.4]	87 lbs. [34 kgs.]	80 lbs. [36 kgs.]
MSV1-17	17	2	11.4 [29.0]	20.8 [53.1]	32.2 [82.0]	89 lbs. [35 kgs.]	81 lbs. [37 kgs.]
MSV1-19	19	2	11.4 [29.0]	22.3 [56.7]	33.7 [85.6]	90 lbs. [35 kgs.]	83 lbs. [38 kgs.]
MSV1-21	21	3	11.8 [30.0]	23.7 [60.3]	35.5 [90.2]	101 lbs. [46 kgs.]	89 lbs. [40 kgs.]
MSV1-23	23	3	11.8 [30.0]	25.1 [63.9]	36.9 [93.8]	102 lbs. [46 kgs.]	91 lbs. [41 kgs.]
MSV1-25	25	3	11.8 [30.0]	26.5 [67.5]	38.3 [97.4]	104 lbs. [47 kgs.]	92 lbs. [42 kgs.]
MSV1-27	27	3	11.8 [30.0]	27.9 [71.1]	39.7 [101]	106 lbs. [48 kgs.]	94 lbs. [43 kgs.]

NOTE: Dimensions are in inches (centimeters) and have a tolerance of ±1/8"

** Dimension may vary due to motor manufacturer's specifications.

▲ When Ordering Add the Correct Suffix (-?P) to Model Number Indicating Phase (ex. MSV1-2-1P)

SINGLE PHASE (-1P) VOLTAGES	60HZ= 3/4 HP - 2 HP 115/208-230 VAC and 3 HP 208-230 VAC 50HZ= 110/220 VAC except 3 HP 220 VAC ONLY
THREE PHASE (-3P) VOLTAGES	60HZ= 3/4 HP - 3 HP 208-230/460 VAC 50HZ= 190/380 VAC

NOTE: Electric supply for ALL motors must be within ± 10% of nameplate voltage rating (e.g. 230V ± 10% = 207 to 253.)