

INSTRUCTION MANUAL

IM354\_REV 1 PRINTED IN CHINA

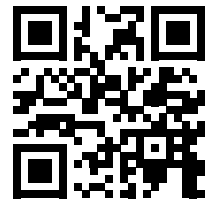

---

# Sump and Effluent Pump

---



---

# Table of Contents

1	Introduction and Safety.....	2
1.1	Introduction.....	2
1.2	Safety.....	2
1.2.1	Safety terminology and symbols.....	2
1.2.2	User safety.....	3
1.3	Protecting the environment.....	4
2	Transportation and Storage.....	5
2.1	Examine the delivery.....	5
2.1.1	Examine the package.....	5
2.1.2	Examine the unit.....	5
3	Product Description.....	6
3.1	General description.....	6
4	Installation.....	7
4.1	Preinstallation.....	7
4.1.1	Pump location guidelines.....	7
4.1.2	Piping checklist.....	7
4.2	Typical installation.....	8
4.3	Wiring and grounding.....	8
4.4	Install the pump.....	9
5	Operation.....	10
5.1	Start the pump.....	10
6	Maintenance.....	11
6.1	Maintenance guidelines.....	11
7	Troubleshooting.....	12
7.1	Operation troubleshooting.....	12
8	Product Warranty.....	14

# 1 Introduction and Safety

## 1.1 Introduction

### Purpose of this manual

The purpose of this manual is to provide necessary information for:

- Installation
- Operation
- Maintenance



### CAUTION:

Read this manual carefully before installing and using the product. Improper use of the product can cause personal injury and damage to property, and may void the warranty.

### NOTICE:

Save this manual for future reference, and keep it readily available at the location of the unit.

## 1.2 Safety



### WARNING:

- The operator must be aware of safety precautions to prevent physical injury.
- Operating, installing, or maintaining the unit in any way that is not covered in this manual could cause death, serious personal injury, or damage to the equipment. This includes any modification to the equipment or use of parts not provided by Xylem. If there is a question regarding the intended use of the equipment, please contact a Xylem representative before proceeding.
- Do not change the service application without the approval of an authorized Xylem representative.



### CAUTION:

You must observe the instructions contained in this manual. Failure to do so could result in physical injury, damage, or delays.

### 1.2.1 Safety terminology and symbols



#### About safety messages

It is extremely important that you read, understand, and follow the safety messages and regulations carefully before handling the product. They are published to help prevent these hazards:

- Personal accidents and health problems
- Damage to the product and its surroundings
- Product malfunction



#### Hazard levels

Hazard level	Indication
 <p><b>DANGER:</b></p>	<p>A hazardous situation which, if not avoided, will result in death or serious injury</p>

Hazard level	Indication
 <b>WARNING:</b>	A hazardous situation which, if not avoided, could result in death or serious injury
 <b>CAUTION:</b>	A hazardous situation which, if not avoided, could result in minor or moderate injury
<b>NOTICE:</b>	Notices are used when there is a risk of equipment damage or decreased performance, but not personal injury.

### Special symbols

Some hazard categories have specific symbols, as shown in the following table.

Electrical hazard	Magnetic fields hazard
 <b>Electrical Hazard:</b>	 <b>CAUTION:</b>

## 1.2.2 User safety

### General safety rules

These safety rules apply:

- Always keep the work area clean.
- Pay attention to the risks presented by gas and vapors in the work area.
- Avoid all electrical dangers. Pay attention to the risks of electric shock or arc flash hazards.
- Always bear in mind the risk of drowning, electrical accidents, and burn injuries.

### Safety equipment

Use safety equipment according to the company regulations. Use this safety equipment within the work area:

- Hard hat
- Safety goggles, preferably with side shields
- Protective shoes
- Protective gloves
- Gas mask
- Hearing protection
- First-aid kit
- Safety devices

#### **NOTICE:**

Never operate a unit unless safety devices are installed. Also see specific information about safety devices in other chapters of this manual.

### Electrical connections

Electrical connections must be made by certified electricians in compliance with all international, national, state, and local regulations. For more information about requirements, see sections dealing specifically with electrical connections.

## 1.3 Protecting the environment

### Emissions and waste disposal

Observe the local regulations and codes regarding:

- Reporting of emissions to the appropriate authorities
- Sorting, recycling and disposal of solid or liquid waste
- Clean-up of spills

### Exceptional sites



---

#### **CAUTION: Radiation Hazard**

Do NOT send the product to Xylem if it has been exposed to nuclear radiation, unless Xylem has been informed and appropriate actions have been agreed upon.

---

### Recycling guidelines

Always follow local laws and regulations regarding recycling.

# 2 Transportation and Storage

## 2.1 Examine the delivery

### 2.1.1 Examine the package

1. Examine the package for damaged or missing items upon delivery.
2. Record any damaged or missing items on the receipt and freight bill.
3. If anything is out of order, then file a claim with the shipping company.  
If the product has been picked up at a distributor, make a claim directly to the distributor.

### 2.1.2 Examine the unit

1. Remove packing materials from the product.  
Dispose of all packing materials in accordance with local regulations.
2. To determine whether any parts have been damaged or are missing, examine the product.
3. If applicable, unfasten the product by removing any screws, bolts, or straps.  
Use care around nails and straps.
4. If there is any issue, then contact a sales representative.

# 3 Product Description

## 3.1 General description

### Description

Sump pumps are designed to run intermittently and usually seasonally.

### Intended applications



---

**WARNING:**

This product can expose you to chemicals including Lead, which is known to the State of California to cause cancer and birth defects or other reproductive harm. For more information go to: [www.P65Warnings.ca.gov](http://www.P65Warnings.ca.gov).

---

Specially designed for the following uses:

- Basement draining
- Water transfer
- Effluent transfer
- Filtered effluent

# 4 Installation

## 4.1 Preinstallation



### WARNING:

- Disconnect and lock out electrical power before installing or servicing the unit.
- Do NOT install this pump in swimming pools or marine areas.
- Risk of electric shock. This pump is supplied with a grounding conductor and grounding-type attachment plug. Install or connect to a circuit that is protected by a GFCI, ground fault circuit interruptor.
- Electrical supply must be in accordance with the specifications given on the pump's nameplate.
- Failure to follow these instructions could result in serious personal injury, death and/or property damage.

### These general requirements apply:

- The electrical outlet must be within the length limitations of the pump power cord and at least four feet above floor level to minimize possible hazards from floor conditions.
- Do not use pumps in water over 140°F (60°C)
- Do not use pumps in mud, sand, cement, oil, or chemicals.
- Do not use a sump pump as a trench or excavation pump, or for pumping sewage, gasoline, or other hazardous liquids.
- Do not modify the pump in any way.
- Do not lift or carry the pump by the power cord.
- Do not remove any tags from pump or cords.
- Do consider a two pump system with an alarm where an installation may become overloaded.
- Do inspect and test system for proper operations at least every three months.
- Always verify that the pump nameplate Amps, Voltage, Phase, HP rating match the power supply.
- Be sure to record the model numbers and serial numbers from the pump for future reference.

### 4.1.1 Pump location guidelines

Guideline	Explanation
Make sure that the space around the pump and switch are sufficient.	The switch must be able to operate freely.
The depth must be deeper than the minimum depth at which the switch turns the pump on.	As an example, if the pump turns on at 7.50", the basin must be deeper than 7.50".
Determine whether a cover is required.	Install a cover when: <ul style="list-style-type: none"> <li>• Installation is in an area where debris could enter and clog the pump.</li> <li>• In a traffic area such as a basement where children and pets are allowed. A bolt-on or child-proof cover is recommended.</li> </ul>

### 4.1.2 Piping checklist

Guideline	Explanation
Discharge pipe should be the same size as the pump.	This insures optimum performance. Undersized pipe can dramatically reduce the flow and waste energy.

## 4.2 Typical installation

Typical pump installation in sump; Tether float shown, float not needed on models with included float.

One type of installation shown below. Note check valve can be installed before union also.

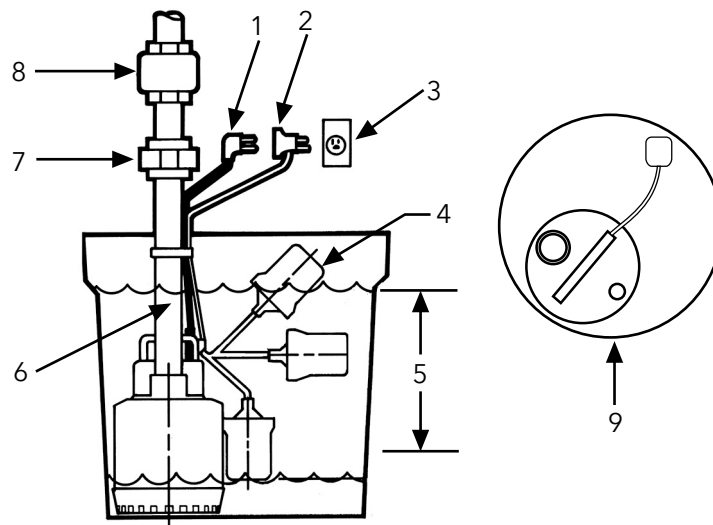

1. Pump electrical plug
2. Piggyback switch plug
3. Grounded wall outlet
4. Float switch
5. Pumping range
6. 1/8" "Relief" hole
7. Union
8. Check valve
9. Pump position

## 4.3 Wiring and grounding



### WARNING:

- Make sure that you have grounded (earthed) the pump, the drive unit, and the controls before connecting the electrical power.
- Install, earth (ground), and wire the equipment according to the local and National Electrical Code Requirements.
- Install a power switch near the pump that disconnects all the conductors.
- Disconnect and lock out electrical power before installing or servicing the unit.
- Electrical supply must be in accordance with the specifications given on the pump's nameplate.
- All splices must be waterproof. If using splice kits, follow manufacturer's instructions.
- Select the correct type and NEMA grade junction box for the application and location. The junction box must insure dry, safe wiring connections.
- Seal all controls from gases present which may damage electrical components.
- Failure to permanently ground the pump, motor and controls before connecting to power can cause shock, burns, or death.

---

**NOTICE:**

- Use only copper wire to the drive unit and the ground (earth). The ground (earth) wire must be at least as thick as the wire to the drive unit.
  - Conductors should have color codes to make the maintenance easier.
- 

## 4.4 Install the pump

DO NOT place the pump directly on earth, gravel or debris. This can cause excessive wear of the impeller and possible jamming.

A. Provide a hard level bottom of bricks or concrete.

B. Remove all debris from the bottom of the sump pit.

1. Install a threaded pipe adapter into the threaded pump discharge.
2. Install a line check valve just above the union to prevent backflow of water after each pump cycle.
3. Connect the discharge pipe to the pump.
4. Lower the pump into the pit, making sure the float switch has adequate clearance and will not hang up on the pit wall. See "Typical installation".

The float must be free to move and not come in contact with the pump body, piping, or other objects.

5. Securely tape or clamp power cord to discharge pipe, clear of the float mechanisms.

# 5 Operation

## 5.1 Start the pump

1. Turn the power On at the breaker panel and/or the disconnect switch.
2. Fill the basin with water and observe the level of water where the pump turns On and Off. The pump should go On well before the water overflows the top of the sump. The pump should go Off before the water gets below the pump suction.
3. Install a cover on the sump pump basin if there is a danger of debris, children, or pets falling into the basin.

# 6 Maintenance

## 6.1 Maintenance guidelines

- Check frequently for debris and/or build-up which can interfere with pump or float operation.
- Test pump periodically throughout the seasons.
  1. Fill sump with water.
  2. Check for debris and proper switch operation.
  3. Remove debris which could clog the suction strainer or jam the switch.
  4. Insure that the switch operates freely and does not hit the sump wall or hang-up on piping or power cords.

---

**NOTICE:**

Failure to follow the maintenance guidelines, including to test unit periodically, may lead to property damage due to loss of pump function.

---

# 7 Troubleshooting

## 7.1 Operation troubleshooting

Symptom	Cause	Remedy
Motor not running	Tripped thermal protector	Check that all pump functions and components are operating correctly. Allow the unit to cool for 30 minutes. If the thermal protector does not reset and no other causation exists, replace the pump.
	Open circuit breaker or blown fuse	Check that the unit is securely plugged in. Have an electrician check all wiring for proper connections and adequate voltage and fuse sizes.
	Defective motor	Replace the pump.
	Low voltage	If the voltage is under the recommended minimum, check the size of the wiring from the main switch on the property. If the main switch is up to code, contact power company or hydro authority.
	Pump clogged	Flush the piping system and clean the pump casing.
Little or no liquid delivered	Air locked	Turn off the pump, clean out the anti-airlock hole, restart the pump.
	Low voltage	If the voltage is under the recommended minimum, check the size of the wiring from the main switch on the property. If the main switch is up to code, contact power company or hydro authority.
	System head too high	Purchase different pump or adjust system.
	Pump clogged / rotating parts binding	Flush the piping system and clean the pump casing.
	Improper check valve direction	Remove check valve and examine for freedom of operation and proper installation.
Pump will not turn off	System head too high	Purchase different pump or adjust system.
	Pump clogged	Flush the piping system and clean the pump casing.
	Level control defective or switch not properly positioned	Install pump as shown in installation section. If problem persists, replace switch.
	Improper check valve direction	Remove check valve and examine for freedom of operation and proper installation.
	Inflow excessive for size of pump	Purchase different pump appropriate for your system.
Pump cycles constantly	Level control defective or switch not properly positioned	Install pump as shown in installation section. If problem persists, replace switch.

---

Symptom	Cause	Remedy
	Check valve leaking	Remove check valve and examine for freedom of operation and proper installation.
	Incorrect size basin or wet-well	Adjust system or replace basin with appropriate size.
	Inflow excessive for size of pump	Purchase different pump appropriate for your system.

# 8 Product Warranty

## Commercial warranty

**Warranty.** For goods sold to commercial buyers, Seller warrants the goods sold to Buyer hereunder (with the exception of membranes, seals, gaskets, elastomer materials, coatings and other "wear parts" or consumables all of which are not warranted except as otherwise provided in the quotation or sales form) will be (i) be built in accordance with the specifications referred to in the quotation or sales form, if such specifications are expressly made a part of this Agreement, and (ii) free from defects in material and workmanship for a period of twenty-four (24) months from the date of installation or thirty (30) months from the date of shipment (which date of shipment shall not be greater than sixty (60) days after receipt of notice that the goods are ready to ship), whichever shall occur first, unless a longer period is specified in the product documentation (the "Warranty").

Except as otherwise required by law, Seller shall, at its option and at no cost to Buyer, either repair or replace any product which fails to conform with the Warranty provided Buyer gives written notice to Seller of any defects in material or workmanship within ten (10) days of the date when any defects or non-conformance are first manifest. Under either repair or replacement option, Seller shall not be obligated to remove or pay for the removal of the defective product or install or pay for the installation of the replaced or repaired product and Buyer shall be responsible for all other costs, including, but not limited to, service costs, shipping fees and expenses. Seller shall have sole discretion as to the method or means of repair or replacement. Buyer's failure to comply with Seller's repair or replacement directions shall terminate Seller's obligations under this Warranty and render the Warranty void. Any parts repaired or replaced under the Warranty are warranted only for the balance of the warranty period on the parts that were repaired or replaced. Seller shall have no warranty obligations to Buyer with respect to any product or parts of a product that have been: (a) repaired by third parties other than Seller or without Seller's written approval; (b) subject to misuse, misapplication, neglect, alteration, accident, or physical damage; (c) used in a manner contrary to Seller's instructions for installation, operation and maintenance; (d) damaged from ordinary wear and tear, corrosion, or chemical attack; (e) damaged due to abnormal conditions, vibration, failure to properly prime, or operation without flow; (f) damaged due to a defective power supply or improper electrical protection; or (g) damaged resulting from the use of accessory equipment not sold or approved by Seller. In any case of products not manufactured by Seller, there is no warranty from Seller; however, Seller will extend to Buyer any warranty received from Seller's supplier of such products.

**THE FOREGOING WARRANTY IS EXCLUSIVE AND IN LIEU OF ANY AND ALL OTHER EXPRESS OR IMPLIED WARRANTIES, GUARANTEES, CONDITIONS OR TERMS OF WHATEVER NATURE RELATING TO THE GOODS PROVIDED HEREUNDER, INCLUDING WITHOUT LIMITATION ANY IMPLIED WARRANTIES OF MERCHANTABILITY AND FITNESS FOR A PARTICULAR PURPOSE, WHICH ARE HEREBY EXPRESSLY DISCLAIMED AND EXCLUDED. EXCEPT AS OTHERWISE REQUIRED BY LAW, BUYER'S EXCLUSIVE REMEDY AND SELLER'S AGGREGATE LIABILITY FOR BREACH OF ANY OF THE FOREGOING WARRANTIES ARE LIMITED TO REPAIRING OR REPLACING THE PRODUCT AND SHALL IN ALL CASES BE LIMITED TO THE AMOUNT PAID BY THE BUYER FOR THE DEFECTIVE PRODUCT. IN NO EVENT SHALL SELLER BE LIABLE FOR ANY OTHER FORM OF DAMAGES, WHETHER DIRECT, INDIRECT, LIQUIDATED, INCIDENTAL, CONSEQUENTIAL, PUNITIVE, EXEMPLARY OR SPECIAL DAMAGES, INCLUDING BUT NOT LIMITED TO LOSS OF PROFIT, LOSS OF ANTICIPATED SAVINGS OR REVENUE, LOSS OF INCOME, LOSS OF BUSINESS, LOSS OF PRODUCTION, LOSS OF OPPORTUNITY OR LOSS OF REPUTATION.**

## Limited consumer warranty

**Warranty.** For goods sold for personal, family or household purposes, Seller warrants the goods purchased hereunder (with the exception of membranes, seals, gaskets, elastomer

materials, coatings and other "wear parts" or consumables all of which are not warranted except as otherwise provided in the quotation or sales form) will be free from defects in material and workmanship for a period of twenty-four (24) months from the date of installation or thirty (30) months from the product date code, whichever shall occur first, unless a longer period is provided by law or is specified in the product documentation (the "Warranty").

Except as otherwise required by law, Seller shall, at its option and at no cost to Buyer, either repair or replace any product which fails to conform with the Warranty provided Buyer gives written notice to Seller of any defects in material or workmanship within ten (10) days of the date when any defects or non-conformance are first manifest. Under either repair or replacement option, Seller shall not be obligated to remove or pay for the removal of the defective product or install or pay for the installation of the replaced or repaired product and Buyer shall be responsible for all other costs, including, but not limited to, service costs, shipping fees and expenses. Seller shall have sole discretion as to the method or means of repair or replacement. Buyer's failure to comply with Seller's repair or replacement directions shall terminate Seller's obligations under this Warranty and render this Warranty void. Any parts repaired or replaced under the Warranty are warranted only for the balance of the warranty period on the parts that were repaired or replaced. The Warranty is conditioned on Buyer giving written notice to Seller of any defects in material or workmanship of warranted goods within ten (10) days of the date when any defects are first manifest.

Seller shall have no warranty obligations to Buyer with respect to any product or parts of a product that have been: (a) repaired by third parties other than Seller or without Seller's written approval; (b) subject to misuse, misapplication, neglect, alteration, accident, or physical damage; (c) used in a manner contrary to Seller's instructions for installation, operation and maintenance; (d) damaged from ordinary wear and tear, corrosion, or chemical attack; (e) damaged due to abnormal conditions, vibration, failure to properly prime, or operation without flow; (f) damaged due to a defective power supply or improper electrical protection; or (g) damaged resulting from the use of accessory equipment not sold or approved by Seller. In any case of products not manufactured by Seller, there is no warranty from Seller; however, Seller will extend to Buyer any warranty received from Seller's supplier of such products.

**THE FOREGOING WARRANTY IS PROVIDED IN PLACE OF ALL OTHER EXPRESS WARRANTIES. ALL IMPLIED WARRANTIES, INCLUDING BUT NOT LIMITED TO THE IMPLIED WARRANTIES OF MERCHANTABILITY AND FITNESS FOR A PARTICULAR PURPOSE, ARE LIMITED TO ONE (1) YEAR FROM THE DATE OF INSTALLATION OR EIGHTEEN (18) MONTHS FROM THE PRODUCT DATE CODE, WHICHEVER SHALL OCCUR FIRST. EXCEPT AS OTHERWISE REQUIRED BY LAW, BUYER'S EXCLUSIVE REMEDY AND SELLER'S AGGREGATE LIABILITY FOR BREACH OF ANY OF THE FOREGOING WARRANTIES ARE LIMITED TO REPAIRING OR REPLACING THE PRODUCT AND SHALL IN ALL CASES BE LIMITED TO THE AMOUNT PAID BY THE BUYER FOR THE DEFECTIVE PRODUCT. IN NO EVENT SHALL SELLER BE LIABLE FOR ANY OTHER FORM OF DAMAGES, WHETHER DIRECT, INDIRECT, LIQUIDATED, INCIDENTAL, CONSEQUENTIAL, PUNITIVE, EXEMPLARY OR SPECIAL DAMAGES, INCLUDING BUT NOT LIMITED TO LOSS OF PROFIT, LOSS OF ANTICIPATED SAVINGS OR REVENUE, LOSS OF INCOME, LOSS OF BUSINESS, LOSS OF PRODUCTION, LOSS OF OPPORTUNITY OR LOSS OF REPUTATION.**

Some states do not allow limitations on how long an implied warranty lasts, so the above limitation may not apply to you. Some states do not allow the exclusion or limitation of incidental or consequential damages, so the above exclusions may not apply to you. This warranty gives you specific legal rights, and you may also have other rights which may vary from state to state.

To make a warranty claim, check first with the dealer from whom you purchased the product or visit [www.xyleminc.com](http://www.xyleminc.com) for the name and location of the nearest dealer providing warranty service.





# Xylem |'zīləm|

- 1) The tissue in plants that brings water upward from the roots;
- 2) a leading global water technology company.

We're a global team unified in a common purpose: creating advanced technology solutions to the world's water challenges. Developing new technologies that will improve the way water is used, conserved, and re-used in the future is central to our work. Our products and services move, treat, analyze, monitor and return water to the environment, in public utility, industrial, residential and commercial building services settings. Xylem also provides a leading portfolio of smart metering, network technologies and advanced analytics solutions for water, electric and gas utilities. In more than 150 countries, we have strong, long-standing relationships with customers who know us for our powerful combination of leading product brands and applications expertise with a strong focus on developing comprehensive, sustainable solutions.

**For more information on how Xylem can help you, go to [www.xylem.com](http://www.xylem.com)**



Visit our Web site for the latest version of this document and more information

The original instruction is in English. All non-English instructions are translations of the original instruction.

© 2022 Xylem Inc