

BALDOR® • **RELIANCE**

Product Information Packet

CECP3587T

2HP,1755RPM,3PH,60HZ,145TC,0535M,TEFC,F1

Part Detail							
Revision:	P	Status:	PRD/A	Change #:		Proprietary:	No
Type:	AC	Prod. Type:	0534M	Elec. Spec:	05WGX009	CD Diagram:	CD0005
Enclosure:	TEFC	Mfg Plant:		Mech. Spec:	05F007	Layout:	05LYF007
Frame:	145TC	Mounting:	F1	Poles:	04	Created Date:	12-29-2008
Base:	RG	Rotation:	R	Insulation:	F	Eff. Date:	07-19-2016
Leads:	9#18					Replaced By:	
Literature:		Elec. Diagram:					

Nameplate NP3258E			
CAT.NO.	CECP3587T		
SPEC.	05F007X009G1		
HP	2	TE	
VOLTS	208-230/460		
AMP	6-5.6/2.8		
RPM	1755		
FRAME	145TC	HZ	60
SER.F.	1.15	CODE	L DES B
RATING	40C AMB-CONT		
SN			
DE	6205	ODE	6205
NEMA-NOM-EFF	88.5	PF	75
G.MIN.EFF	86.5	CC	010A
T. CODE	T4	T=	135
		PH	3
		CL	F

Nameplate NP3261E	
SPEC.	05F007X009G1
D.E. BRG.	25BC02XP30X
O.D.E. BRG.	25BC02XP30X
GREASE	POLYREX EM
RPM MAX	2700
	MAX. KVAR N/A
BLANK	
INV. TYPE	PWM
T=	135
C HP FR	60
CT HZ FROM	1.5
VT HZ FROM	0-
HTR-VOLTS	
HTR-WATTS	
C HP TO	90
CT HZ TO	60
VT HZ TO	60
HTR-AMPS	
	MAX. SPACE HEATER TEMP.

Parts List		
Part Number	Description	Quantity
SA178736	SA 05F007X009G1	1.000 EA
RA166809	RA 05F007X009G1	1.000 EA
34FN3002B01	EXTERNAL FAN, PLASTIC, .637/.639 HUB W/	1.000 EA
HW3201A05	3/8-16 EYEBOLT	1.000 EA
06CB1000A02G	CONDUIT BOX, MACH GRAY	1.000 EA
RM1016	LEAD SEPARATOR GASKET - 305/306 C.P.MOTO	1.000 EA
51XW2520A12	SCREW, HEX SER SLT HD, ZN, 1/4-20 X .75	2.000 EA
11XW1032G06	10-32 X .38, TAPTITE II, HEX WSHR SLTD U	1.000 EA
HW3001B01	BRASS CUP WASHER, FOR #8 SCREW	1.000 EA
10XN2520S06	1/4 20X3/8 HX HD CAP S.S.	2.000 EA
WD1000B16	T&B CX70TN TERMINAL	2.000 EA
35EP1102B03G	FREP TEFC 205 BRG,GRSR,RLF,.125 NPT DRAI	1.000 EA
HW4500A19	1/4-28X1/4 SLOTTED PLUG F/S	1.000 EA
HW4500A17	317400 ALEMITE GREASE RELIEF	1.000 EA
HA4054	SHORT T-DRAIN FITTING, .125" N.P.T.	1.000 EA
HW5100A05	WVY WSHR F/205 & 304 BRGS	1.000 EA
35EP1329A16G	PUEP ENCL 143-5TC 205 BRG,GRSR,RLF,NPT D	1.000 EA
HW4500A19	1/4-28X1/4 SLOTTED PLUG F/S	1.000 EA
HW4500A17	317400 ALEMITE GREASE RELIEF	1.000 EA
HA4054	SHORT T-DRAIN FITTING, .125" N.P.T.	1.000 EA
51XN1032A20	10-32 X 1 1/4 HX WS SL SR	2.000 EA
HA3100A28	THRUBOLT 10-32 X 8.187	4.000 EA
51XB1214A16	12-14X1.00 HXWSSLD SERTYB	1.000 EA
35FH1000A01G	35FH1000A01 W/GRAY FLUIDIZ	1.000 EA

Parts List (continued)		
Part Number	Description	Quantity
10XN2520A16	1/4-20 X 1 HEX HEAD CAP SCR, ZINC PLATED	3.000 EA
HW1001A25	LOCKWASHER 1/4, ZINC PLT .493 OD, .255 I	3.000 EA
WD4100A03	DE-750 HEYCO PLUG 62MP0750 MICRO PLASTIC	1.000 EA
06CB1502A01G	LIPPED CONDUIT BOX LID, MACH GRAY EPOXY	1.000 EA
06GS1003	GASKET, KOBX LID, 1/8" THICK BLACK NEOPR	1.000 EA
10XN2520A12	O1/4-20X 3/4 HEX HEAD CAP	2.000 EA
HW1001A25	LOCKWASHER 1/4, ZINC PLT .493 OD, .255 I	2.000 EA
HW4600B32SP	V-RING SLINGER 1.000 X 1.540 X .24 VITON	1.000 EA
HA1005A03SP	SLINGER, OD 1.750, ID .938, 205 BRG	1.000 EA
HW2501D13	KEY, 3/16 SQ X 1.375	1.000 EA
HA7000A01	KEY RETAINER 7/8" DIA SHAFT	1.000 EA
MJ5001A27	32220KN GRAY SEALER *MIN BUY 4 QTS=1GAL	0.001 QT
85XU0407S04	4X1/4 U DRIVE PIN STAINLESS	2.000 EA
LB1115N	LABEL,LIFTING DEVICE (ON ROLLS)	1.000 EA
LB1002N	LABEL,MARINE DUTY (ON ROLLS)	1.000 EA
MJ1000A02	GREASE, POLYREX EM EXXON (USe 4824-15A)	0.050 LB
MG1025N19	WILKOFAS, 778.50, RELIANCE BLUE-GREEN	0.022 GA
LC0005E01	CONN.DIA./WARNING LABEL (LC0005/LB1119N)	1.000 EA
LB1449	DIV-2/NEC WARNING LABEL	1.000 EA
NP3258E	SS CP SUPER-E DIV-2 UL CSA-C US EEV CC	1.000 EA
NP3261E	SS CP SUPER-E AUX DATA INFORMATION	1.000 EA
85XU0407S04	4X1/4 U DRIVE PIN STAINLESS	2.000 EA
36PA1000	PKG GRP, PRINT PK1016A06	1.000 EA
MN416A01	TAG-INSTAL-MAINT no wire (1200/bx) 11/14	1.000 EA

AC Induction Motor Performance Data

Record # 47104 - Typical performance - not guaranteed values

Winding: 05WGX009-R039	Type: 0534M	Enclosure: TEFC
-------------------------------	--------------------	------------------------

Nameplate Data				460 V, 60 Hz: High Voltage Connection	
Rated Output (HP)	2			Full Load Torque	5.99 LB-FT
Volts	208-230/460			Start Configuration	direct on line
Full Load Amps	6-5.6/2.8			Breakdown Torque	25.8 LB-FT
R.P.M.	1755			Pull-up Torque	14.7 LB-FT
Hz	60	Phase	3	Locked-rotor Torque	17.5 LB-FT
NEMA Design Code	B	KVA Code	L	Starting Current	24.8 A
Service Factor (S.F.)	1.15			No-load Current	1.66 A
NEMA Nom. Eff.	88.5	Power Factor	75	Line-line Res. @ 25°C	6.28 Ω
Rating - Duty	40C AMB-CONT			Temp. Rise @ Rated Load	39°C
S.F. Amps				Temp. Rise @ S.F. Load	46°C
				Locked-rotor Power Factor	46.5
				Rotor inertia	0.201 LB-FT ²

Load Characteristics 460 V, 60 Hz, 2 HP

% of Rated Load	25	50	75	100	125	150	S.F.
Power Factor	34	54	67	75	80	83	78
Efficiency	80.6	87.2	88.9	88.7	88.2	87.2	88.2
Speed	1789	1780	1770	1759	1748	1736	1748
Line amperes	1.75	2.01	2.37	2.82	3.31	3.86	3.14

Performance Graph at 460V, 60Hz, 2.0HP Typical performance - Not guaranteed values

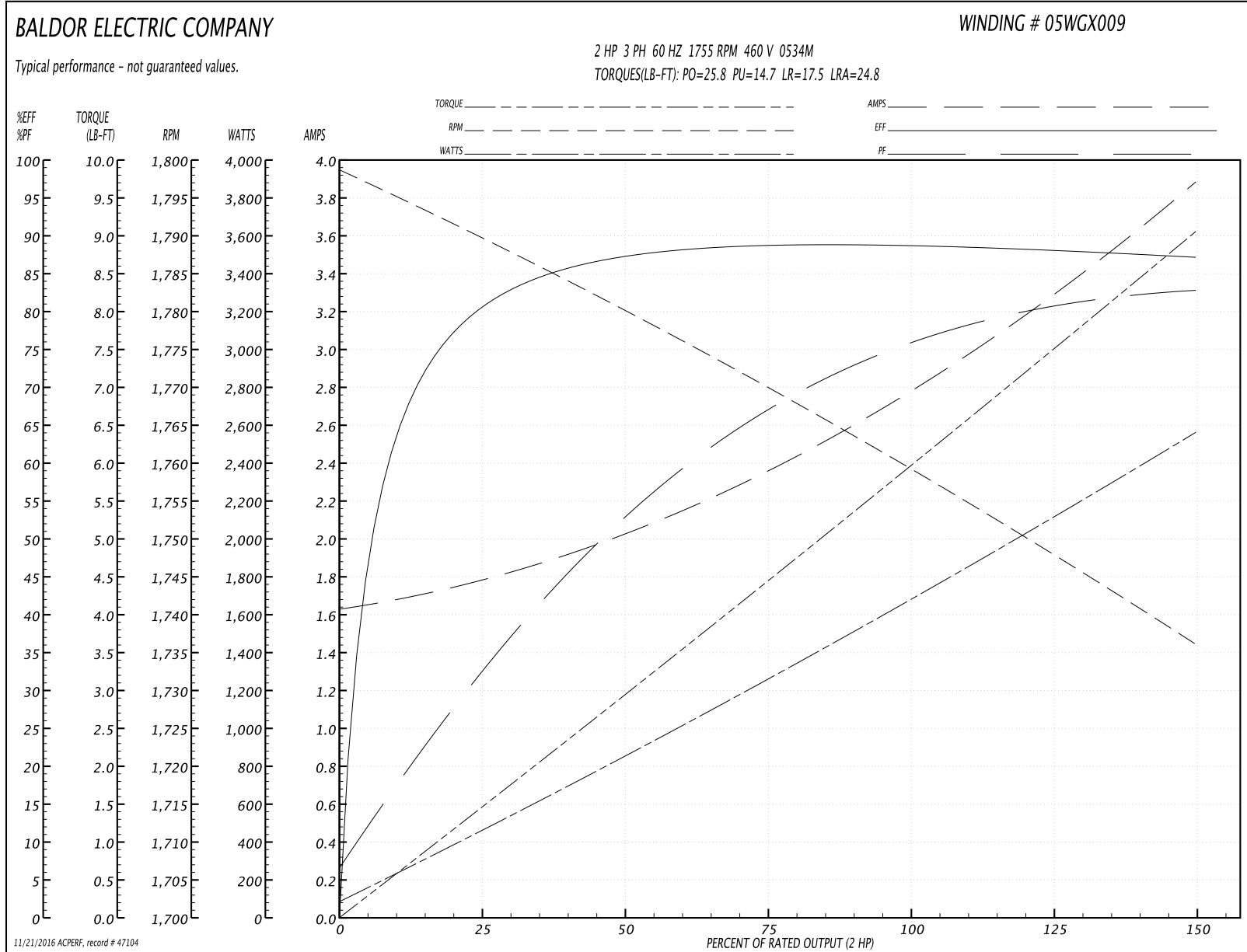

AC Induction Motor Performance Data

Record # 47862 - Typical performance - not guaranteed values

Winding: 05WGX009-R039	Type: 0534M	Enclosure: TEFC
-------------------------------	--------------------	------------------------

Nameplate Data				230 V, 60 Hz: Low Voltage Connection	
Rated Output (HP)	2			Full Load Torque	5.99 LB-FT
Volts	208-230/460			Start Configuration	direct on line
Full Load Amps	6-5.6/2.8			Breakdown Torque	25.8 LB-FT
R.P.M.	1755			Pull-up Torque	14.7 LB-FT
Hz	60	Phase	3	Locked-rotor Torque	17.5 LB-FT
NEMA Design Code	B	KVA Code	L	Starting Current	49.6 A
Service Factor (S.F.)	1.15			No-load Current	3.32 A
NEMA Nom. Eff.	88.5	Power Factor	75	Line-line Res. @ 25°C	1.57 Ω
Rating - Duty	40C AMB-CONT			Temp. Rise @ Rated Load	39°C
S.F. Amps				Temp. Rise @ S.F. Load	46°C
				Locked-rotor Power Factor	46.5
				Rotor inertia	0.201 LB-FT ²

Load Characteristics 230 V, 60 Hz, 2 HP

% of Rated Load	25	50	75	100	125	150	S.F.
Power Factor	34	54	67	75	80	83	78
Efficiency	80.6	87.2	88.9	88.7	88.2	87.2	88.1
Speed	1789	1780	1770	1759	1748	1736	1748
Line amperes	3.5	4.02	4.74	5.63	6.63	7.72	6.27

Performance Graph at 230V, 60Hz, 2.0HP Typical performance - Not guaranteed values

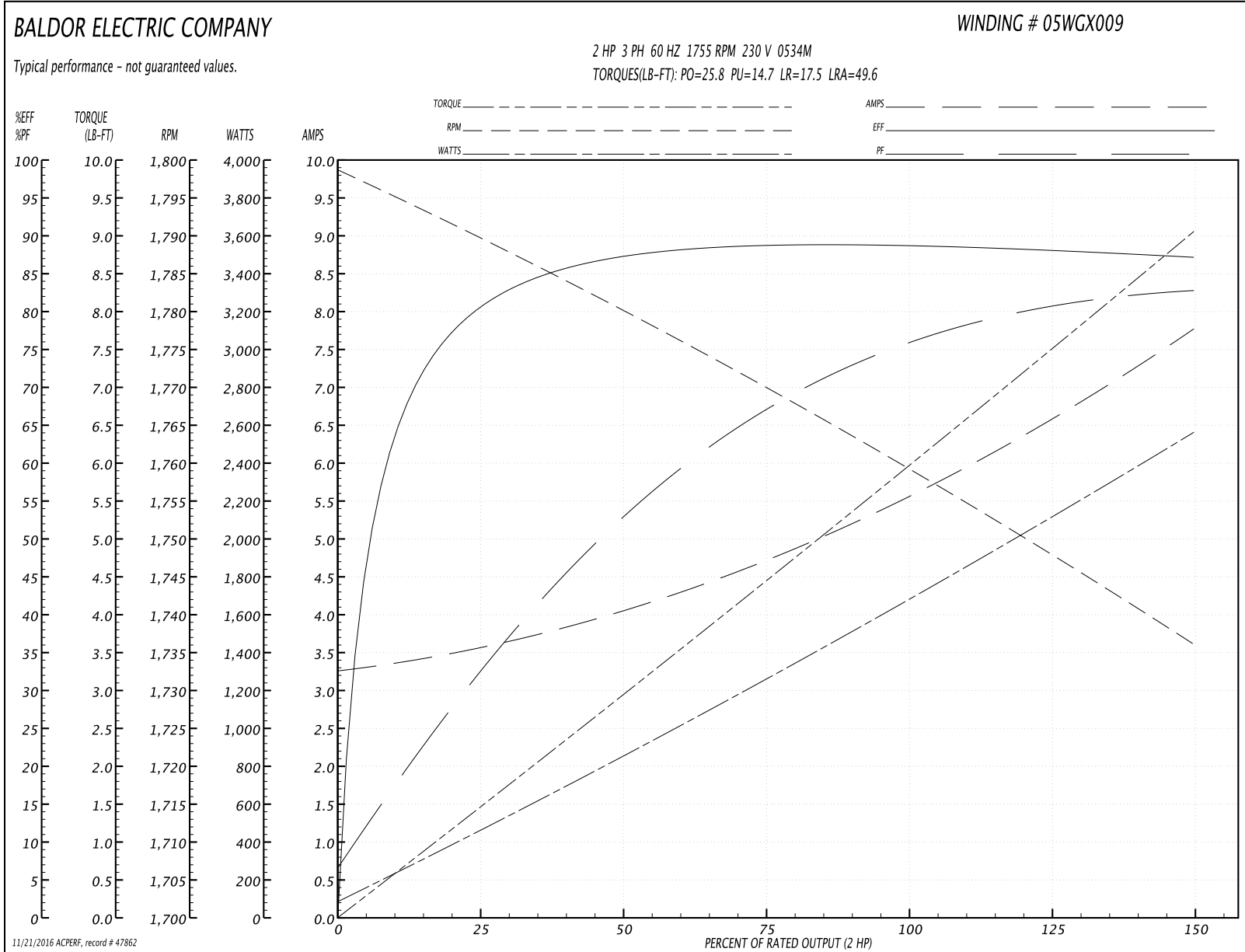

AC Induction Motor Performance Data

Record # 47863 - Typical performance - not guaranteed values

Winding: 05WGX009-R039	Type: 0534M	Enclosure: TEFC
-------------------------------	--------------------	------------------------

Nameplate Data				208 V, 60 Hz: Low Voltage Connection	
Rated Output (HP)	2			Full Load Torque	6.02 LB-FT
Volts	208-230/460			Start Configuration	direct on line
Full Load Amps	6-5.6/2.8			Breakdown Torque	20.9 LB-FT
R.P.M.	1755			Pull-up Torque	11.8 LB-FT
Hz	60	Phase	3	Locked-rotor Torque	14 LB-FT
NEMA Design Code	B	KVA Code	L	Starting Current	44.3 A
Service Factor (S.F.)	1.15			No-load Current	2.85 A
NEMA Nom. Eff.	88.5	Power Factor	75	Line-line Res. @ 25°C	1.57 Ω
Rating - Duty	40C AMB-CONT			Temp. Rise @ Rated Load	40°C
S.F. Amps				Temp. Rise @ S.F. Load	49°C
				Locked-rotor Power Factor	46
				Rotor inertia	0.201 LB-FT ²

Load Characteristics 208 V, 60 Hz, 2 HP

% of Rated Load	25	50	75	100	125	150	S.F.
Power Factor	40	62	74	80	84	86	82
Efficiency	83.6	88.4	89.4	88.6	87.5	86	87.6
Speed	1788	1776	1764	1751	1736	1720	1737
Line amperes	3.11	3.82	4.73	5.84	7.05	8.4	6.64

Performance Graph at 208V, 60Hz, 2.0HP Typical performance - Not guaranteed values

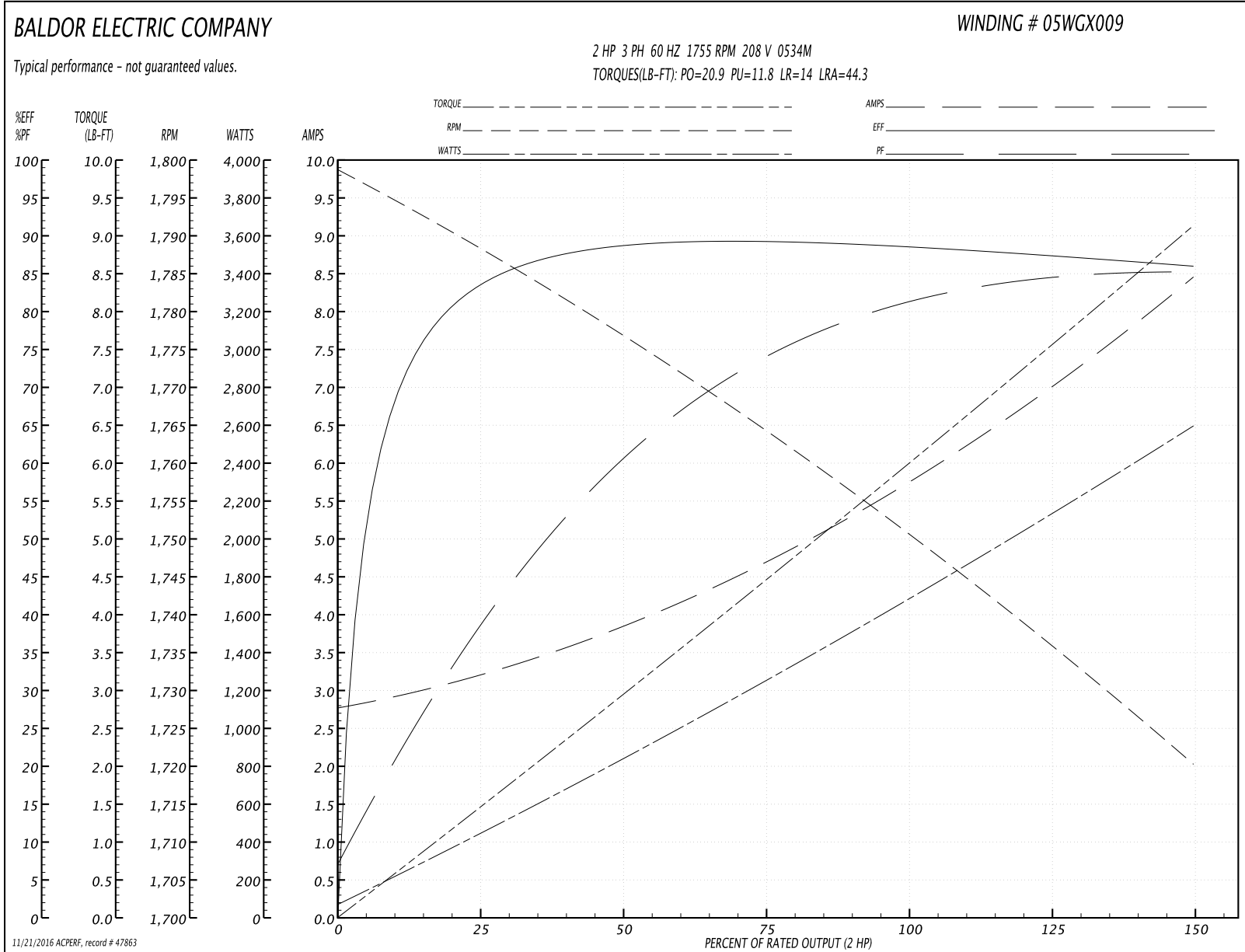

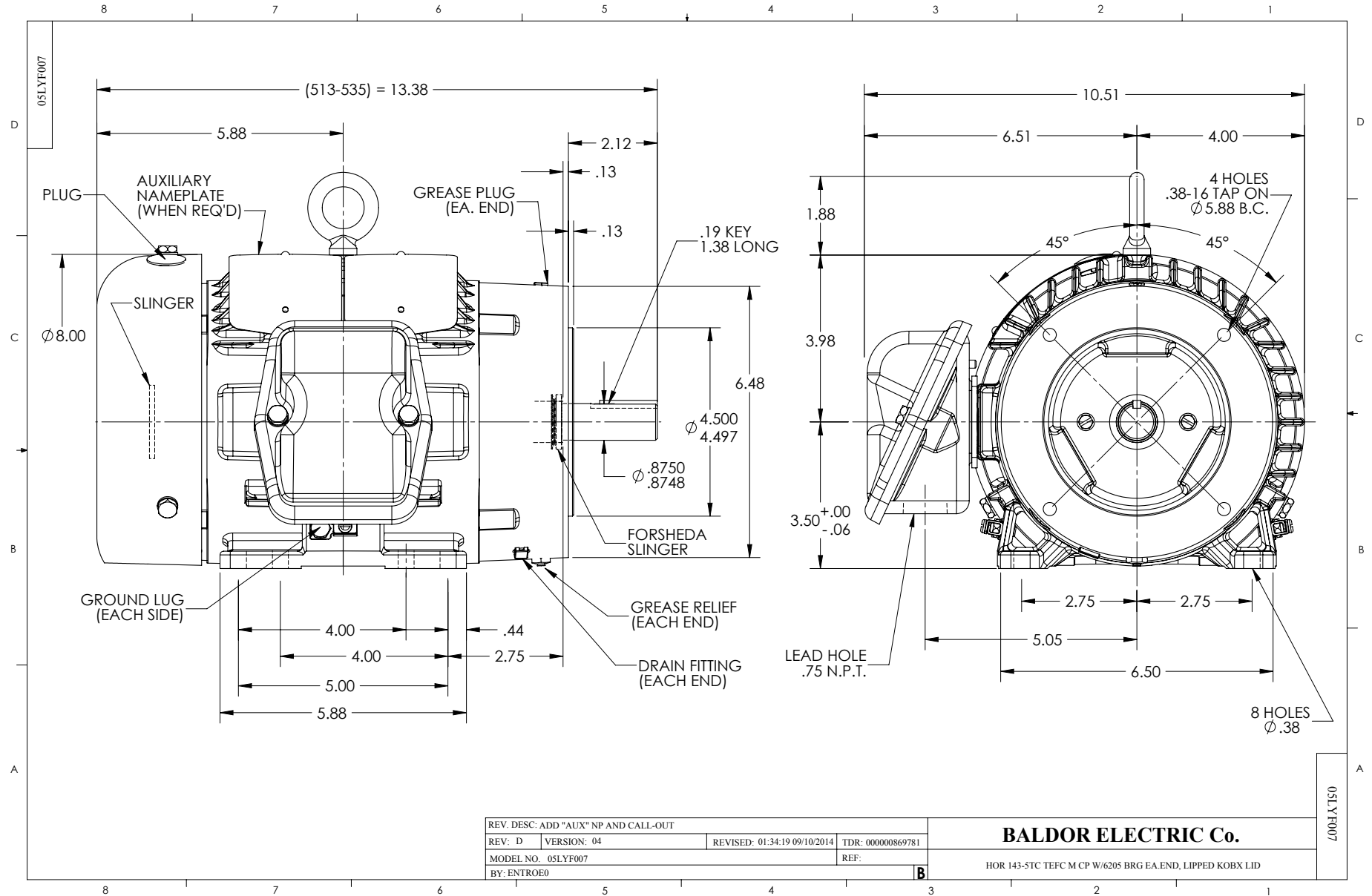

CD0005

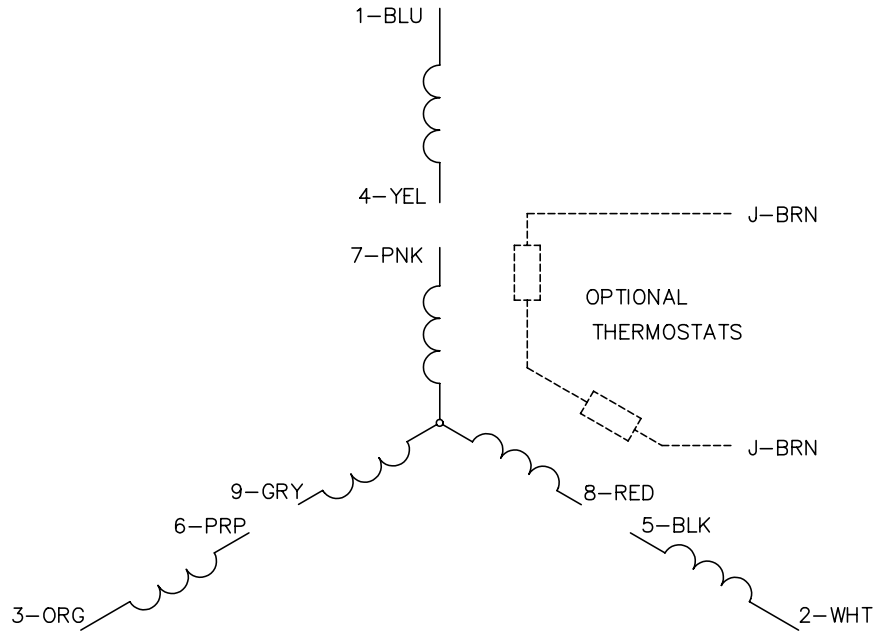

LOW VOLTAGE
(2Y)

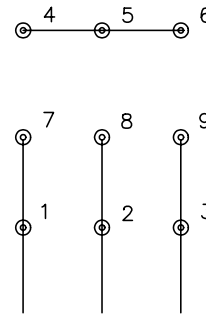

LINE

HIGH VOLTAGE
(1Y)

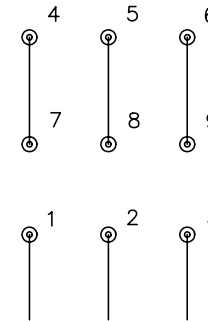

LINE

NOTES:

1. INTERCHANGE ANY TWO LINE LEADS TO REVERSE ROTATION.
2. OPTIONAL THERMOSTATS ARE PROVIDED WHEN SPECIFIED.
3. ACTUAL NUMBER OF INTERNAL PARALLEL CIRCUITS MAY BE A MULTIPLE OF THOSE SHOWN ABOVE.
4. LEAD COLORS ARE OPTIONAL. LEADS MUST ALWAYS BE NUMBERED AS SHOWN.

REV. DESC: REVISE TO SHOW OPTIONAL COLORS			
REV. LTR: E	BY: JLP	REVISED: 01/19/99 10:15	TDR: 0171435
9000D		FILE: AAA00005140	MDL: -
		MTL: -	

BALDOR ELECTRIC Co.

3PH, DV, 9 LEADS

CD0005