

# **BALDOR**® • **RELIANCE**

## **Product Information Packet**

# **EM2555T-4G**

**100HP,1780RPM,3PH,60HZ,404T,4476M,OPSB,F**

Part Detail							
Revision:	K	Status:	PRD/A	Change #:		Proprietary:	No
Type:	AC	Prod. Type:	4476M	Elec. Spec:	44WGW048	CD Diagram:	CD0382
Enclosure:	OPSB	Mfg Plant:		Mech. Spec:	44E227	Layout:	44LYE227
Frame:	404T	Mounting:	F1	Poles:	04	Created Date:	12-10-2011
Base:	RG	Rotation:	R	Insulation:	H	Eff. Date:	01-13-2017
Leads:	6#6					Replaced By:	
Literature:		Elec. Diagram:					

Nameplate NP2138L											
CAT.NO.	EM2555T-4G			P/N				ENCLOSURE	OPSB		
SPEC.	44E227W048G1		CC	010A	FRAME	404T		S/N			
HP	100			CLASS	H	HZ	60				
RPM	1780		PH	3	DES	B					
VOLT	460			KVA-CODE	G		ODE BRG	6312		DE BRG	6316
AMP	115			USABLE AT 208V							
RATING	40C AMB-CONT			GREASE	POLYREX EM						
NEMA-NOM-EFF	95.4	PF	85	SER.F.	1.15						
HTR-VOLTS			HTR-AMPS			MAX. SPACE HEATER TEMP.					

Parts List		
Part Number	Description	Quantity
SA235634	SA 44E227W048G1	1.000 EA
RA222593	RA 44E227W048G1	1.000 EA
S/P107-000-004	SUPER-E(284 FR. & UP)-CL PLANT,POLYREX E	1.000 EA
HA6731	LIFTING LUG FOR 44 FRAME MOTORS.	2.000 EA
HA6648A01	CAST ADAPTER, 44 FRAME - NEMA 404-5 - MA	1.000 EA
19XW3816A16	.38-16 X 1.00 HEX WASHER HEAD TAPTITE II	2.000 EA
HW1001A38	LOCKWASHER 3/8, ZINC PLT .688 OD, .382 I	2.000 EA
18CB1006A04	CB 318 3.62 LD HOLE, .38 MTG HOLE & 3.88	1.000 EA
19XW3118A16	.31-18 HEX WASHER HEAD TAPTITE II 1.00 L	4.000 EA
HW1001A31	LOCKWASHER 5/16, ZINC PLT.591 OD, .319 I	4.000 EA
WD1000B25	GND LUG, BURNDY L125HP OR T&B L125HP-BB	1.000 EA
10XN3118K08	5/16-18 X .50 GRADE #5, STL, ZINC PLATE	1.000 EA
HW1001A31	LOCKWASHER 5/16, ZINC PLT.591 OD, .319 I	1.000 EA
44EP1203A02	FREP, MACH	1.000 EA
HW5100A15	W4997-050 WVY WSHR (WB)	1.000 EA
10XN3816K48	3/8-16 X 3 HEX HD CAP SCREW,Z/P	4.000 EA
HW1001A38	LOCKWASHER 3/8, ZINC PLT .688 OD, .382 I	4.000 EA
44EP1202A01	PU ENDPLATE, MACH.	1.000 EA
XY5013A12	NUT,1/2-13,HEX,STEEL,ZINCPLATED	8.000 EA
18CB1506A01	CB LID 318 FOR 18CB1006	1.000 EA
10XN3118K16	5/16-18 X 1' GRADE #5, STL, ZINC PLATE	4.000 EA
HW1001A31	LOCKWASHER 5/16, ZINC PLT.591 OD, .319 I	4.000 EA
HW2501K66	KEY, 3/4 SQ X 5.625	1.000 EA
LB1115N	LABEL,LIFTING DEVICE (ON ROLLS)	1.000 EA

<b>Parts List (continued)</b>		
<b>Part Number</b>	<b>Description</b>	<b>Quantity</b>
MN416A01	TAG-INSTAL-MAINT no wire (1000/bx) 11/14	1.000 EA
HW4500A03	GREASE FITTING, .125 NPT 1610(ALEMITE) 8	1.000 EA
HW4500A20	1/8NPT SL PIPE PLUG	1.000 EA
HA4051A00	PLASTIC CAP FOR GREASE FITTING	1.000 EA
MJ1000A02	GREASE, POLYREX EM EXXON (USe 4824-15A)	0.030 LB
HW4500A03	GREASE FITTING, .125 NPT 1610(ALEMITE) 8	1.000 EA
HW4500A20	1/8NPT SL PIPE PLUG	1.000 EA
HA4051A00	PLASTIC CAP FOR GREASE FITTING	1.000 EA
MG1000Y03	MUNSELL 2.53Y 6.70/ 4.60, GLOSS 20,	0.080 GA
85XU0407S04	4X1/4 U DRIVE PIN STAINLESS	4.000 EA
44AD2001A02	BAFFLE 44 OPEN,"X"=1.50, SLOTTED BAND MT	1.000 EA
44AD2001A02	BAFFLE 44 OPEN,"X"=1.50, SLOTTED BAND MT	1.000 EA
HA3175A04	THRUBOLT STUD 1/2-13 X 26.000 - GRADE 2	4.000 EA
LB1119N	WARNING LABEL	1.000 EA
LC0382	CONNECTION LABEL	1.000 EA
NP2138L	ALUM SUPER-E UL CSA-EEV PREM CC (300	1.000 EA
44PA1000	PK GP COMB PRINT 39-3/8X31X23-7/8	1.000 EA

**AC Induction Motor Performance Data**

Record # 50234 - Typical performance - not guaranteed values

<b>Winding:</b> 44WGW048-R002	<b>Type:</b> 4476M	<b>Enclosure:</b> OPSB
-------------------------------	--------------------	------------------------

Nameplate Data				460 V, 60 Hz: Single Voltage Motor	
Rated Output (HP)	100			Full Load Torque	295 LB-FT
Volts	460			Start Configuration	direct on line
Full Load Amps	115			Breakdown Torque	843 LB-FT
R.P.M.	1780			Pull-up Torque	409 LB-FT
Hz	60	Phase	3	Locked-rotor Torque	500 LB-FT
NEMA Design Code	B	KVA Code	G	Starting Current	765 A
Service Factor (S.F.)	1.15			No-load Current	41.5 A
NEMA Nom. Eff.	95.4	Power Factor	85	Line-line Res. @ 25°C	0.0465 Ω
Rating - Duty	40C AMB-CONT			Temp. Rise @ Rated Load	40°C
S.F. Amps				Temp. Rise @ S.F. Load	53°C
				Locked-rotor Power Factor	25
				Rotor inertia	14.4 LB-FT <sup>2</sup>

Load Characteristics 460 V, 60 Hz, 100 HP

% of Rated Load	25	50	75	100	125	150	S.F.
Power Factor	51	73	82	85	86	86	86
Efficiency	93.1	95.4	95.8	95.6	95.2	94.5	95.4
Speed	1796	1791	1786	1781	1775	1769	1777
Line amperes	49.4	67.7	89.5	115.2	143	172.6	131.9

Performance Graph at 460V, 60Hz, 100.0HP Typical performance - Not guaranteed values

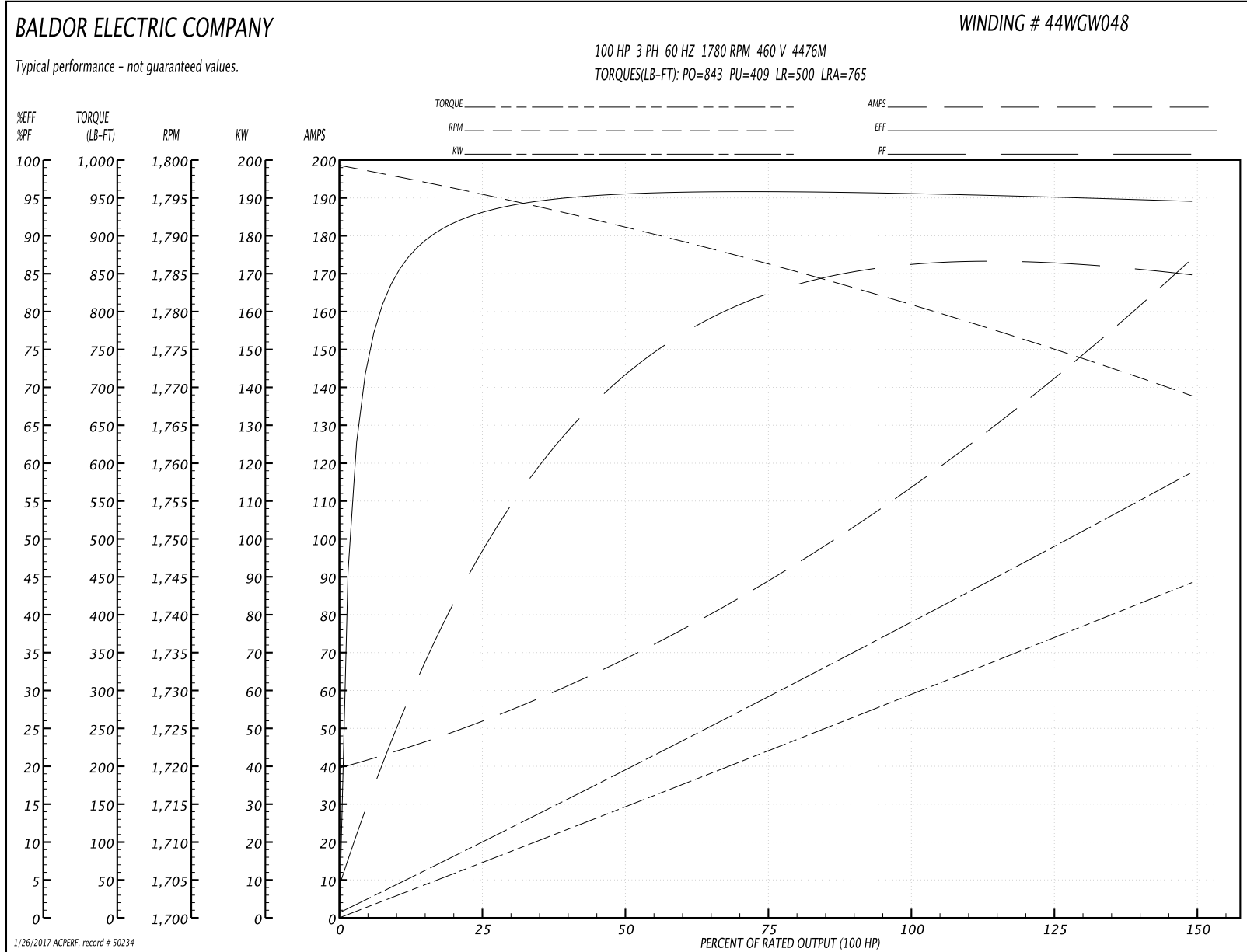

44LYE227

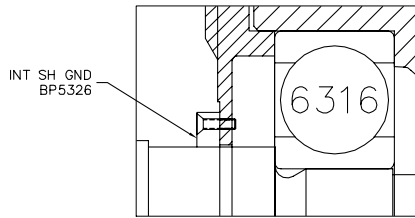
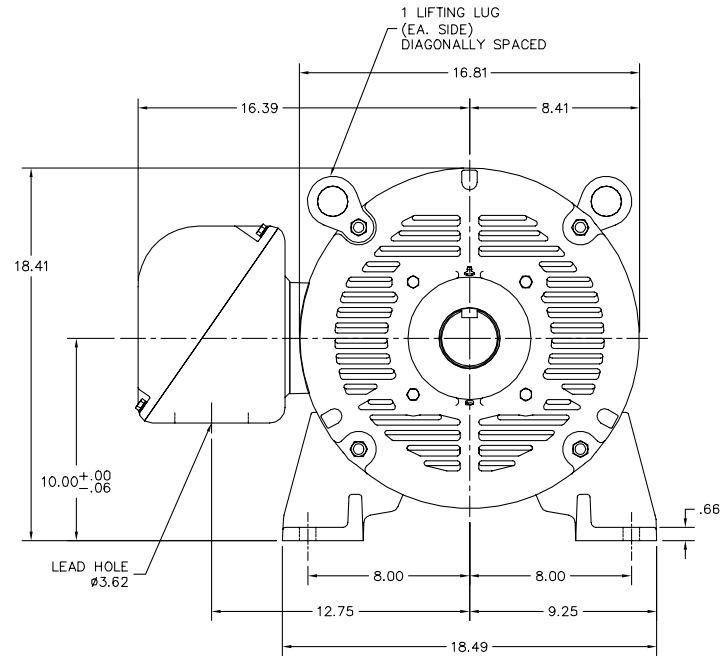
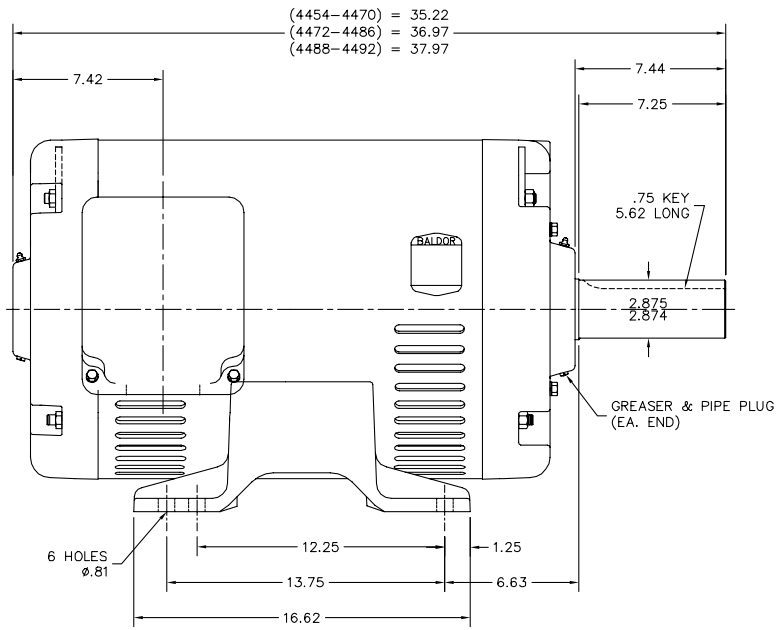

PI. RETAINER DETAIL

CUSTOMER IS RESPONSIBLE FOR DETERMINING THAT BALDOR'S PRODUCT WILL PERFORM SUITABLY IN THE INTENDED APPLICATION.

REV. DESC: REMOVE LOCKNUT PROVISIONS		
REV. LTR: A	VERSION: 01	TDR: 000000959631
FILE: \AAA\00187\459	REVISED: 09:41:45 01/05/2016	BY: ENMARSO
MTL: -		

**BALDOR**

HORZ OPSB 404-5T W/INT SH GND  
SH 1 of 1

44LYE227

CD0382

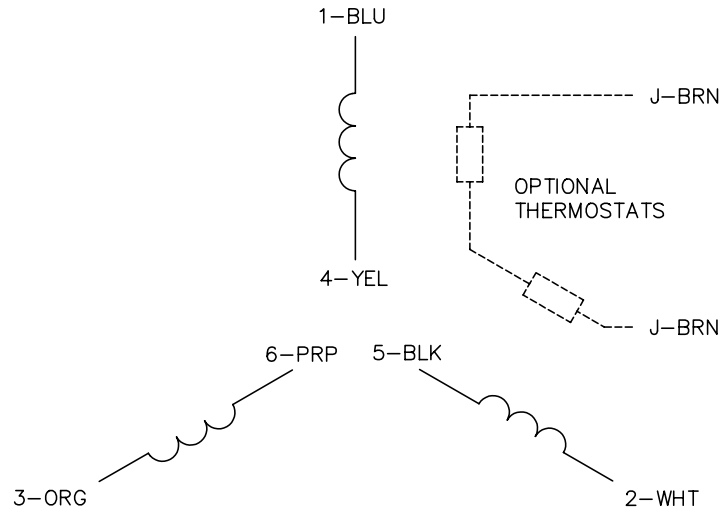

RUN CONNECTION (1D)

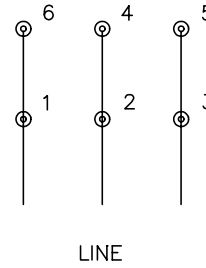

START CONNECTION (1Y)

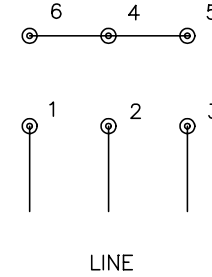

NOTES:

1. INTERCHANGE ANY TWO LINE LEADS TO REVERSE ROTATION.
2. OPTIONAL THERMOSTATS ARE PROVIDED WHEN SPECIFIED.
3. ACTUAL NUMBER OF INTERNAL PARALLEL CIRCUITS MAY BE A MULTIPLE OF THOSE SHOWN ABOVE.
4. LEAD COLORS ARE OPTIONAL. LEADS MUST ALWAYS BE NUMBERED AS SHOWN.
5. FOR ACROSS-THE-LINE STARTING, USE 'RUN' CONNECTION.

REV. DESC: ADD NOTE 5 FOR DOL STARTING			
REV. LTR: E	BY: JLP	REVISED: 11/30/00 2:26	TDR: 0226155
CD0382		FILE: AAA00005243	REF: -
		MTL: -	

**BALDOR ELECTRIC Co.**

3PH, SV, 6 LEADS, Y START/D RUN

CD0382