

# NBE, NBSE, NKE, TPE, TPED

Series 2000 and 1000

Installation and operating instructions



# NBE, NBSE, NKE, TPE, TPED

---

<b>English (US)</b>	
Installation and operating instructions . . . . .	3
<b>Français (CA)</b>	
Notice d'installation et de fonctionnement . . . . .	61
<b>Español (MX)</b>	
Instrucciones de instalación y operación . . . . .	119
Appendix . . . . .	177
Annexe . . . . .	179
Anexo . . . . .	181

Original installation and operating instructions

**CONTENTS**

	<b>Page</b>		
<b>1. Limited warranty</b>	<b>4</b>	11.17	Limit-exceeded function 38
<b>2. General information</b>	<b>4</b>	11.18	"Pulse flowmeter setup" 39
2.1 Symbols used in this document	4	11.19	"Ramps" 39
2.2 Other important notes	4	11.20	"Standstill heating" 39
2.3 Abbreviations and definitions	5	11.21	Motor bearing monitoring 40
2.4 Radio communication	5	11.22	"Service" 40
2.5 Battery	5	11.23	"Number" (Pump number) 40
<b>3. Receiving the product</b>	<b>5</b>	11.24	"Radio communication" (Enable/disable radio comm.) 40
3.1 Transporting the product	5	11.25	Language 40
3.2 Inspecting the product	5	11.26	"Date and time" (Set date and time) 40
<b>4. Mechanical installation</b>	<b>5</b>	11.27	"Unit configuration" (Units) 40
4.1 Handling the product	5	11.28	"Buttons on product" (Enable/disable settings) 41
4.2 Mounting the product	6	11.29	Delete history 41
4.3 Cable entries	6	11.30	Define Home display 41
4.4 Ensuring motor cooling	6	11.31	Display settings 41
4.5 Outdoor installation	6	11.32	"Store settings" (Store actual settings) 41
4.6 Drain holes	6	11.33	"Recall settings" (Recall stored settings) 41
<b>5. Electrical installation</b>	<b>6</b>	11.34	"Undo" 41
5.1 Protection against electric shock, indirect contact	7	11.35	"Pump name" 41
5.2 Cable requirements	7	11.36	"Connection code" 42
5.3 Mains supply	7	11.37	Run start-up guide 42
5.4 Additional protection	8	11.38	Alarm log 42
5.5 Connection terminals	9	11.39	Warning log 42
5.6 Signal cables	11	11.40	Assist 42
5.7 Bus connection cable	11	11.41	Assisted pump setup 43
<b>6. Operating conditions</b>	<b>12</b>	11.42	Setup, analog input 43
6.1 Maximum number of starts and stops	12	11.43	"Multipump setup" (Setup of multi-pump system) 43
6.2 Alternating operation of twin-head pumps	12	11.44	Description of control mode 46
6.3 Ambient temperature	12	11.45	Assisted fault advice 46
6.4 Installation altitude	12	<b>12. Selection of control mode</b>	<b>47</b>
6.5 Humidity	13	<b>13. Bus signal</b>	<b>48</b>
6.6 Motor cooling	13	<b>14. Priority of settings</b>	<b>49</b>
<b>7. User interfaces</b>	<b>13</b>	<b>15. Grundfos Eye</b>	<b>50</b>
<b>8. Standard control panel</b>	<b>13</b>	<b>16. Signal relays</b>	<b>51</b>
8.1 Setpoint setting	14	<b>17. Installing a communication interface module</b>	<b>52</b>
<b>9. Advanced control panel</b>	<b>15</b>	<b>18. Identification of functional module</b>	<b>53</b>
9.1 Home display	16	<b>19. Identification of control panel</b>	<b>54</b>
9.2 Startup guide	16	<b>20. Changing the position of the control panel</b>	<b>54</b>
9.3 Menu overview for advanced control panel	17	<b>21. Servicing the product</b>	<b>55</b>
<b>10. Grundfos GO</b>	<b>20</b>	21.1 Motor	55
10.1 Communication	20	21.2 Pump	55
10.2 Menu overview for Grundfos GO	21	<b>22. Cleaning the product</b>	<b>55</b>
<b>11. Description of functions</b>	<b>24</b>	<b>23. Megging</b>	<b>55</b>
11.1 Setpoint	24	<b>24. Technical data, single-phase motors</b>	<b>56</b>
11.2 Operating mode	24	24.1 Supply voltage	56
11.3 Set manual speed	24	24.2 Leakage current	56
11.4 "Set user-defined speed"	24	<b>25. Technical data, three-phase motors</b>	<b>56</b>
11.5 "Control mode"	24	25.1 Supply voltage	56
11.6 "Proportional-pressure setup"	28	25.2 Leakage current, AC	56
11.7 Analog inputs	29	<b>26. Inputs and outputs</b>	<b>57</b>
11.8 Built-in Grundfos sensor	30	<b>27. Other technical data</b>	<b>58</b>
11.9 Pt100/1000 inputs	30	27.1 Torques	58
11.10 Digital inputs	31	27.2 Sound pressure level	59
11.11 Digital inputs/outputs	32	<b>28. Factory settings</b>	<b>60</b>
11.12 "Signal relays 1 and 2" (Relay outputs)	33	<b>29. Disposing of the product</b>	<b>60</b>
11.13 Analog output	33		
11.14 "Controller" ("Controller settings")	34		
11.15 Operating range	36		
11.16 External setpoint function	36		



Read this document before installing the product. Installation and operation must comply with local regulations and accepted codes of good practice.

## 1. Limited warranty

Products manufactured by Grundfos Pumps Corporation (Grundfos) are warranted to the original user only to be free of defects in material and workmanship for a period of 24 months from date of installation, but not more than 30 months from date of manufacture. Grundfos' liability under this warranty shall be limited to repairing or replacing at Grundfos' option, without charge, F.O.B. Grundfos' factory or authorized service station, any product of Grundfos manufacture. Grundfos will not be liable for any costs of removal, installation, transportation, or any other charges that may arise in connection with a warranty claim.

Products which are sold, but not manufactured by Grundfos, are subject to the warranty provided by the manufacturer of said products and not by Grundfos' warranty.

Grundfos will not be liable for damage or wear to products caused by abnormal operating conditions, accident, abuse, misuse, unauthorized alteration or repair, or if the product was not installed in accordance with Grundfos' printed installation and operating instructions and accepted codes of good practice. The warranty does not cover normal wear and tear.

To obtain service under this warranty, the defective product must be returned to the distributor or dealer of Grundfos' products from which it was purchased together with proof of purchase and installation date, failure date and supporting installation data. Unless otherwise provided, the distributor or dealer will contact Grundfos or an authorized service station for instructions. Any defective product to be returned to Grundfos or a service station must be sent freight prepaid; documentation supporting the warranty claim and/or a Return Material Authorization must be included if so instructed.

Grundfos will not be liable for any incidental or consequential damages, losses, or expenses arising from installation, use, or any other causes. There are no express or implied warranties, including merchantability or fitness for a particular purpose, which extend beyond those warranties described or referred to above. Some jurisdictions do not allow the exclusion or limitation of incidental or consequential damages and some jurisdictions do not allow limitations on how long implied warranties may last. Therefore the above limitations or exclusions may not apply to you. This warranty gives you specific legal rights and you may also have other rights which vary from jurisdiction to jurisdiction.

Products which are repaired or replaced by Grundfos or authorized service center under the provisions of these limited warranty terms will continue to be covered by Grundfos warranty only through the remainder of the original warranty period set forth by the original purchase date.

## 2. General information

These installation and operating instructions are a supplement to the installation and operating instructions for the corresponding standard pumps NB, NBS, NK, TP, TPD. For instructions not mentioned specifically in this manual, see the installation and operating instructions for the standard pump.

The NBE, NBSE, NKE, TPE, TPED pumps are fitted with frequency-controlled permanent-magnet motors for single-phase or three-phase mains connection.

### 2.1 Symbols used in this document

#### 2.1.1 Warnings against hazards involving risk of death or personal injury



#### **DANGER**

Indicates a hazardous situation which, if not avoided, will result in death or serious personal injury.



#### **WARNING**

Indicates a hazardous situation which, if not avoided, could result in death or serious personal injury.



#### **CAUTION**

Indicates a hazardous situation which, if not avoided, could result in minor or moderate personal injury.

The text accompanying the three hazard symbols DANGER, WARNING and CAUTION is structured in the following way:

### 2.2 Other important notes



#### **SIGNAL WORD**

##### **Description of hazard**

Consequence of ignoring the warning.  
- Action to avoid the hazard.



A blue or grey circle with a white graphical symbol indicates that an action must be taken.



A red or grey circle with a diagonal bar, possibly with a black graphical symbol, indicates that an action must not be taken or must be stopped.

## 2.3 Abbreviations and definitions

AI	Analog input.
AL	Alarm, out of range at lower limit.
AO	Analog output.
AU	Alarm, out of range at upper limit.
CIM	Communication interface module.
Current sinking	The ability to draw current into the terminal and guide it towards ground (earth) in the internal circuitry.
Current sourcing	The ability to push current out of the terminal and into an external load which must return it to ground (earth).
DI	Digital input.
DO	Digital output.
ELCB	Earth leakage circuit breaker.
FM	Functional module.
GDS	Grundfos Digital Sensor. Factory-fitted sensor in some Grundfos pumps.
GENiBus	Proprietary Grundfos fieldbus standard.
GFCI	Ground fault circuit interrupter. USA and Canada.
GND	Ground (Earth).
Grundfos Eye	Status indicator light.
LIVE	Low voltage with the risk of electric shock if the terminals are touched.
OC	Open collector: Configurable open-collector output.
PE	Protective earth.
PELV	Protective extra-low voltage. A voltage that cannot exceed ELV under normal conditions and under single-fault conditions, except ground (earth) faults in other circuits.
RCD	Residual-current device
SELV	Safety extra-low voltage. A voltage that cannot exceed ELV under normal conditions and under single-fault conditions, including ground (earth) faults in other circuits.
NBE, NBSE, NKE, TPE	Single-head pump without factory-fitted differential-pressure sensor.
TPED	Twin-head pump without factory-fitted differential-pressure sensor.
NBE, NBSE, NKE, TPE, TPED Series 2000	Single-head pump (NBE, NBSE, NKE, TPE) and twin-head pump (TPED) with factory-fitted differential-pressure sensor.

## 2.4 Radio communication

This product incorporates a radio module for remote control which is a class 1 device and can be used anywhere in the EU member states without restrictions.

For use in USA and Canada, see Appendix.

This product can communicate with Grundfos GO and other products of the same type via the built-in radio module.

In some cases, an external antenna may be required. Only Grundfos-approved external antennas may be connected to this product, and only by a Grundfos-approved installer.

## 2.5 Battery

Pumps fitted with the advanced functional module, FM 300, incorporate a Li-ion battery. The Li-ion battery complies with the Battery Directive (2006/66/EC). The battery does not contain mercury, lead and cadmium.

## 3. Receiving the product

### 3.1 Transporting the product

#### WARNING



##### Falling objects

Death or serious personal injury  
- Secure the product during transportation to prevent it from tilting or falling down.

#### CAUTION



##### Crushing of feet

Minor or moderate personal injury  
- Wear safety shoes when moving the product.

### 3.2 Inspecting the product

Before you install the product, do the following:

- Check that the product is as ordered.
- Check that no visible parts have been damaged.

If parts are damaged or missing, contact your local Grundfos sales company.

## 4. Mechanical installation

### 4.1 Handling the product

Observe local regulations setting limits for manual lifting or handling. The motor weight is stated on the nameplate.

#### CAUTION



##### Back injury

Minor or moderate personal injury  
- Use lifting equipment.

#### CAUTION



##### Crushing of feet

Minor or moderate personal injury  
- Wear safety shoes and attach lifting equipment to the motor eyebolts when handling the product.



Do not lift the product by the terminal box.

## 4.2 Mounting the product

### CAUTION



#### Crushing of feet

- Minor or moderate personal injury
- Secure the product to a solid foundation by bolts through the holes in the flange or the base plate.



In order to maintain the UL mark, additional requirements apply to the equipment. See Appendix.

Secure the pump to a solid foundation by bolts through the holes in the flange or the base plate.

## 4.3 Cable entries

See the size of the cable entries in section 27. *Other technical data*.

## 4.4 Ensuring motor cooling

Leave at least 2 inches (50 mm) between the end of the fan cover and a wall or other fixed objects. See fig. 1.

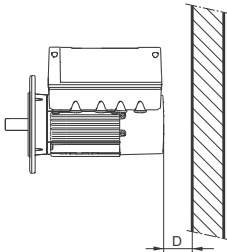

TM05 5236 3512

Fig. 1 Minimum distance, D, from the motor to a wall or other fixed objects

## 4.5 Outdoor installation

If you install the motor outdoors, provide the motor with a cover and open the drain holes to avoid condensation on the electronic components. See figures 2 and 3.



When fitting a cover to the motor, observe the guidelines in section 4.4 *Ensuring motor cooling*.

The cover must be sufficiently large to ensure that the motor is not exposed to direct sunlight, rain or snow. Grundfos does not supply covers. We therefore recommend that you have a cover built for the specific application. In areas with high humidity, we recommend that you connect the motor permanently to the mains supply and activate the built-in standstill heating function. See section 11.20 *"Standstill heating"*, page 39.

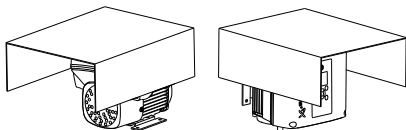

Fig. 2 Examples of covers, not supplied by Grundfos

TM05 3496 3512



In order to maintain the UL mark, additional requirements apply to the equipment. See Appendix.

## 4.6 Drain holes

When the motor is installed in moist surroundings or areas with high humidity, the bottom drain hole must be open. The enclosure class of the motor will then be lower. This helps prevent condensation in the motor as the motor becomes self-venting, and it allows water and humid air to escape.

The motor has a plugged drain hole on the drive side. You can turn the flange 90 ° to both sides or 180 °.

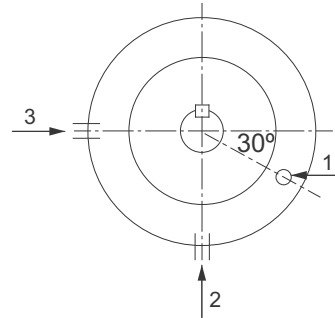

TM07 3800 5220

Fig. 3 Drain holes

Pos.	Description
1	Drain hole for vertically mounted motor
2, 3	Drain hole for horizontally mounted motor

Ensure that the drain hole in the motor flange is open and is facing downwards.

## 5. Electrical installation

### DANGER

#### Electric shock



- Death or serious personal injury
- Switch off the power supply to the motor and to the signal relays. Wait at least 5 minutes before you make any connections in the terminal box. Make sure that the power supply cannot be accidentally switched on.

### DANGER

#### Electric shock



- Death or serious personal injury
- Check that the supply voltage and frequency correspond to the values stated on the nameplate.

If the power supply cable is damaged, it must be replaced by the manufacturer, the manufacturer's service partner or a similarly qualified person.

The user or the installer is responsible for the installation of correct grounding (earthing) and protection according to local regulations. All operations must be carried out by a qualified electrician.

Carry out the electrical connection according to local regulations.

Check that the supply voltage and frequency correspond to the values stated on the nameplate.

## 5.1 Protection against electric shock, indirect contact

### WARNING



#### Electric shock

- Death or serious personal injury
- Connect the motor to protective earth and provide protection against indirect contact in accordance with local regulations.

Protective-earth conductors must always have a yellow and green, PE, or yellow, green and blue, PEN, colour marking.

### 5.1.1 Protection against mains voltage transients

The motor is protected against mains voltage transients in accordance with EN 61800-3.

### 5.1.2 Motor protection

The motor requires no external motor protection. The motor incorporates thermal protection against slow overloading and blocking.

## 5.2 Cable requirements

### 5.2.1 Cable cross-section

### DANGER



#### Electric shock

- Death or serious personal injury
- Always comply with local regulations as to cable cross-sections.

#### 1 x 200-230 V

Power		Conductor type	Cross section	
[hp]	[kW]		[AWG]	[mm <sup>2</sup> ]
0.33 - 2.0	0.25 - 1.5	Solid	16-12	1.5 - 2.5
		Stranded	16-12	1.5 - 2.5

#### 3 x 200-240 V

Power		Conductor type	Cross section	
[hp]	[kW]		[AWG]	[mm <sup>2</sup> ]
1.5 - 2.0	1.1 - 1.5	Solid	16-8	1.5 - 10
		Stranded	16-8	1.5 - 10
3.5 - 7.5	2.5 - 5.5	Solid	14-8	2.5 - 10
		Stranded	14-8	2.5 - 10

#### 3 x 380-500 V

Power		Conductor type	Cross section	
[hp]	[kW]		[AWG]	[mm <sup>2</sup> ]
0.33 - 3.0	0.25 - 2.2	Solid	16-8	1.5 - 10
		Stranded	16-8	1.5 - 10
4.0 - 14.75	3.0 - 11	Solid	14-8	2.5 - 10
		Stranded	14-8	2.5 - 10

### 5.2.2 Conductors

#### Type

Stranded or solid copper conductors.

#### Temperature rating

Temperature rating for conductor insulation: 140 °F (60 °C).

Temperature rating for outer cable sheath: 167 °F (75 °C).

## 5.3 Mains supply

### DANGER



#### Electric shock

- Death or serious personal injury
- Use the recommended fuse size. See sections [24.1 Supply voltage](#) and [25.1 Supply voltage](#).

### 5.3.1 Single-phase supply voltage

- 1 x 200-230 V - 10 %/+ 10 %, 50/60 Hz, PE.

Check that the supply voltage and frequency correspond to the values stated on the nameplate.



If you want to supply the motor through an IT network, make sure that you have a suitable motor variant. If you are in doubt, contact Grundfos.

The wires in the motor terminal box must be as short as possible. Excepted from this is the separated ground (earth) conductor which must be so long that it is the last one to be disconnected in case the cable is inadvertently pulled out of the cable entry.

For maximum backup fuse, see section [24.1 Supply voltage](#).

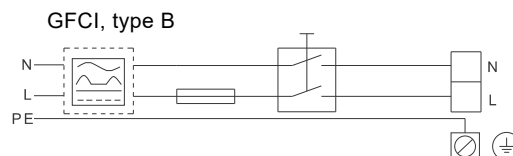

Fig. 4 Example of a mains-connected motor with mains switch, backup fuse and additional protection

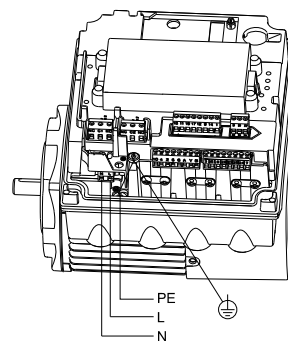

Fig. 5 Mains connection, single-phase motors

TM05 4034 1912

TM05 3494 1512

### 5.3.2 Three-phase supply voltage

Three-phase motors are available for the voltages below:

- 3 x 380-500 V - 10 %/+ 10 %, 50/60 Hz, PE
- 3 x 200-240 V - 10 %/+ 10 %, 50/60 Hz, PE.

Check that the supply voltage and frequency correspond to the values stated on the nameplate.

The wires in the motor terminal box must be as short as possible. Excepted from this is the separated ground (earth) conductor which must be so long that it is the last one to be disconnected in case the cable is inadvertently pulled out of the cable entry.

In order to avoid loose connections, ensure that the terminal block for L1, L2 and L3 is pressed home in its socket when the supply cable has been connected.

For maximum backup fuse, see section [25.1 Supply voltage](#).



If you want to supply the motor through an IT network, make sure that you have a suitable motor variant. If you are in doubt, contact Grundfos.

Only the following motors can be supplied through an IT network:

- Motors with speed of 1450-2000/2200 rpm and up to 2.0 HP (1.5 kW)
- Motors with speed of 2900-4000 rpm or 4000-5900 rpm and up to 3 HP (2.2 kW).



Corner grounding is not allowed for supply voltages above 3 x 480 V, 50/60 Hz.

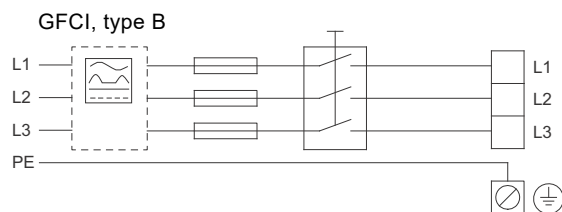

**Fig. 6** Example of a mains-connected motor with mains switch, backup fuses and additional protection

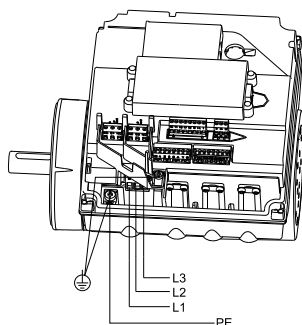

**Fig. 7** Mains connection, three-phase motors

### 5.4 Additional protection

#### DANGER



#### Electric shock

Death or serious personal injury

- Only use residual-current circuit breakers (ELCB, GFCI, RCD) of type B.

The residual-current circuit breaker must be marked with the following symbol:



The total leakage current of all the electrical equipment in the installation must be taken into account. You find the leakage current of the motor in sections [24.2 Leakage current](#) and [25.2 Leakage current, AC](#).

This product can cause a direct current in the protective earth conductor.

#### Overvoltage and undervoltage protection

Overvoltage and undervoltage may occur in case of unstable power supply or a faulty installation. The motor is stopped if the voltage falls outside the permissible voltage range. The motor restarts automatically when the voltage is again within the permissible voltage range. Therefore, no additional protection relay is required.



The motor is protected against transients from the power supply according to EN 61800-3. In areas with high lightning intensity, we recommend external lightning protection.

#### Overload protection

If the upper load limit is exceeded, the motor automatically compensates for this by reducing the speed and stops if the overload condition persists.

The motor remains stopped for a set period. After this period, the motor automatically attempts to restart. The overload protection prevents damage to the motor. Consequently, no additional motor protection is required.

#### Overtemperature protection

The electronic unit has a built-in temperature sensor as an additional protection. When the temperature rises above a certain level, the motor automatically compensates for this by reducing the speed and stops if the temperature keeps rising. The motor remains stopped for a set period. After this period, the motor automatically attempts to restart.

#### Protection against phase unbalance

Three-phase motors must be connected to a power supply with a quality corresponding to IEC 60146-1-1, class C, to ensure correct motor operation at phase unbalance. This also ensures long life of the components.

TM05 3942 1812

TM05 3495 1512

## 5.5 Connection terminals

The descriptions and terminal overviews in this section apply to both single-phase and three-phase motors.

For maximum torques, see section 27.1 *Torques*.

### 5.5.1 Connection terminals, advanced functional module, FM 300

The advanced module has these connections:

- three analog inputs  
The factory-fitted analogue differential-pressure DPI sensor for TPE Series 2000 is connected to one of these inputs.
- one analog output
- two dedicated digital inputs
- two configurable digital inputs or open-collector outputs
- input and output for Grundfos Digital Sensor  
Not applicable for NBE, NBSE, NKE, TPE, TPED pumps. The factory-fitted digital differential-pressure DPS sensor for NBE, NBSE, NKE, TPE, TPED Series 2000 is connected to this input.
- two Pt100/1000 inputs
- two LiqTec sensor inputs
- two signal relay outputs
- GENIbus connection.

See fig. 8.



Digital input 1 is factory-set to be start-stop input where open circuit results in stop. A jumper has been factory-fitted between terminals 2 and 6. Remove the jumper if digital input 1 is to be used as external start-stop or any other external function.

### DANGER

#### Electric shock

Death or serious personal injury  
- Make sure that the wires to be connected to the connection groups below are separated from each other by reinforced insulation in their entire lengths.



#### Inputs and outputs

All inputs and outputs are internally separated from the mains-conducting parts by reinforced insulation and galvanically separated from other circuits. All control terminals are supplied by protective extra-low voltage, PELV, thus ensuring protection against electric shock.

#### Signal relay outputs

- Signal relay 1:  
LIVE:  
You can connect supply voltages up to 250 VAC.  
PELV:  
The output is galvanically separated from other circuits. Therefore, you can connect the supply voltage or protective extra-low voltage to the output as desired.
- Signal relay 2:  
PELV:  
The output is galvanically separated from other circuits. Therefore, you can connect the supply voltage or protective extra-low voltage to the output as desired.

- Mains supply, terminals N, PE, L or L1, L2, L3, PE.

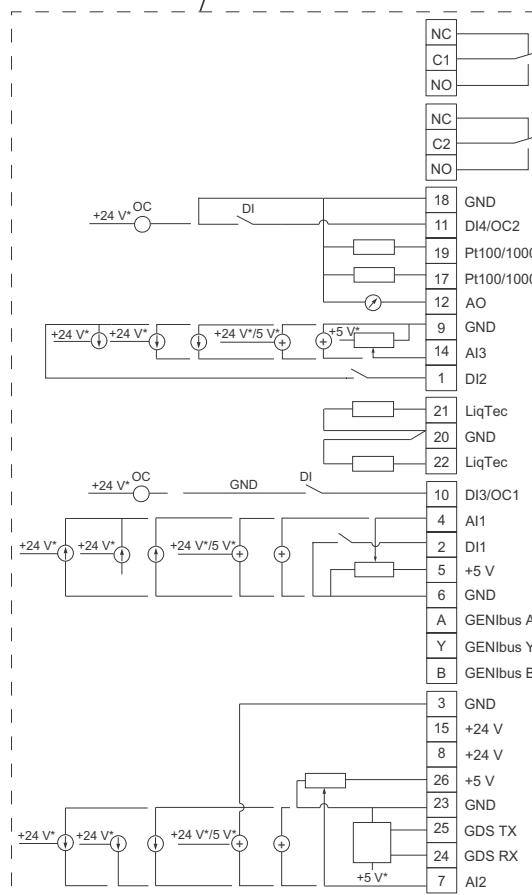
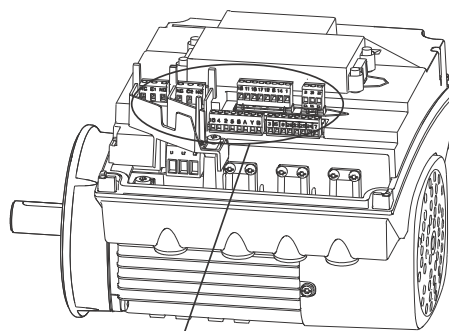

TM05 3509 3512

- \* If you use an external supply source, make sure that there is a connection to GND.

Fig. 8 Connection terminals, FM 300

Terminal	Type	Function
NC	Normally closed contact	Signal relay 1 LIVE or PELV
C1	Common	
NO	Normally open contact	
NC	Normally closed contact	Signal relay 2 PELV only
C2	Common	
NO	Normally open contact	
18	GND	Ground (Earth)
11	DI4/OC2	Digital input and output, configurable. Open collector: Maximum 24 V resistive or inductive.
19	Pt100/1000 input 2	Pt100/1000 sensor input
17	Pt100/1000 input 1	Pt100/1000 sensor input
12	AO	Analog output: 0-20 mA / 4-20 mA 0-10 V
9	GND	Ground (Earth)
14	AI3	Analog input: 0-20 mA / 4-20 mA 0-10 V
1	DI2	Digital input, configurable
21	LiqTec sensor input 1	LiqTec sensor input white conductor
20	GND	Ground (Earth) brown and black conductors
22	LiqTec sensor input 2	LiqTec sensor input blue conductor
10	DI3/OC1	Digital input and output, configurable. Open collector: Maximum 24 V resistive or inductive.
4	AI1	Analog input: 0-20 mA / 4-20 mA 0.5 - 3.5 V / 0-5 V / 0-10 V
2	DI1	Digital input, configurable
5	+5 V	Supply to potentiometer and sensor
6	GND	Ground (Earth)
A	GENIbus, A	GENIbus, A (+)
Y	GENIbus, Y	GENIbus, GND
B	GENIbus, B	GENIbus, B (-)

Terminal	Type	Function
3	GND	Ground (Earth)
15	+24 V	Supply
8	+24 V	Supply
26	+5 V	Supply to potentiometer and sensor
23	GND	Ground (Earth)
25	GDS TX	Grundfos Digital Sensor output
24	GDS RX	Grundfos Digital Sensor input
7	AI2	Analog input: 0-20 mA / 4-20 mA 0.5 - 3.5 V / 0-5 V / 0-10 V

### 5.6 Signal cables

- Use screened cables with a cross-sectional area of minimum 0.5 mm<sup>2</sup> and maximum 1.5 mm<sup>2</sup> for external on/off switch, digital inputs, setpoint and sensor signals.
- Connect the screens of the cables to frame at both ends with good connection. The screens must be as close as possible to the terminals. See fig. 9.

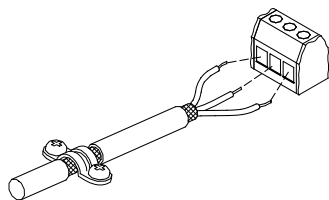

Fig. 9 Stripped cable with screen and wire connections

- Always tighten screws for frame connections whether a cable is fitted or not.
- The wires in the motor terminal box must be as short as possible.

#### Connection of E-pump to Danfoss sensor

The blue wire of the pressure sensor is connected to the #4 terminal of the E-pump. The brown wire of the pressure sensor is connected to the #8 terminal of the E-pump.

See section 5.6 Signal cables for additional details.



Fig. 10 Danfoss sensor

TM02 1325 4402

TM05 1533 2911

### 5.7 Bus connection cable

#### 5.7.1 New installations

For the bus connection, use a screened 3-core cable with a cross-sectional area of minimum 0.5 mm<sup>2</sup> and maximum 1.5 mm<sup>2</sup>.

If the motor is connected to a unit with a cable clamp which is identical to the one on the motor, connect the screen to this cable clamp.

If the unit has no cable clamp, leave the screen unconnected at this end. See fig. 11.

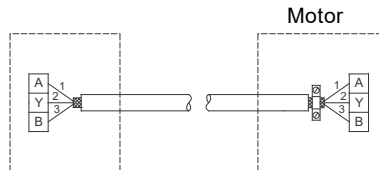

Fig. 11 Connection with screened 3-core cable

#### 5.7.2 Replacing a motor

- If you have used a screened 2-core cable in the existing installation, connect the cable as shown in fig. 12.

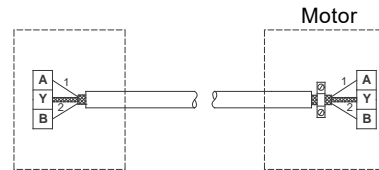

Fig. 12 Connection with screened 2-core cable

- If you have used a screened 3-core cable in the existing installation, follow the instructions in section 5.7.1 New installations.

TM05 3973 1812

TM02 8842 0904

## 6. Operating conditions

### 6.1 Maximum number of starts and stops

The number of starts and stops via the power supply must not exceed four times per hour.

When switched on via the power supply, the pump starts after approximately 5 seconds.

If a higher number of starts and stops is desired, use the input for external start-stop when starting or stopping the pump.

When started via an external on/off switch, the pump starts immediately.

### 6.2 Alternating operation of twin-head pumps

On twin-head pumps, the duty and backup pumps must be alternated on a regular basis, i.e. once a week, to ensure an even distribution of the operating hours on both pumps. The pumps alternate automatically. See section 11.43 "Multipump setup" (Setup of multi-pump system).

If twin-head pumps are used for pumping domestic hot water, the duty and backup pumps must be alternated on a regular basis, i.e. once a day, to avoid blocking of the backup pump due to deposits such as calcareous deposits. As default, the pumps alternate automatically. See section 11.43 "Multipump setup" (Setup of multi-pump system).

### 6.3 Ambient temperature

#### 6.3.1 Ambient temperature during storage and transportation

Minimum: -22 °F (-30 °C)

Maximum: 140 °F (60 °C).

#### 6.3.2 Ambient temperature during operation

	1 x 200-230 V	3 x 200-240 V	3 x 380-500 V
Minimum	-4 °F (-20 °C)	-4 °F (-20 °C)	-4 °F (-20 °C)
Maximum	122 °F (50 °C)	104 °F (40 °C)	122 °F (50 °C)

The motor can operate with the rated power output, P2, at 122 °F (50 °C), but continuous operation at higher temperatures reduces the expected product life. If the motor is to operate at ambient temperatures between 122 and 140 °F (50 and 60 °C) (for 3 x 380-500 V), or 104 and 122 °F (40 and 50 °C) (for 1 x 200-230 V or 3 x 200-240 V), select an oversized motor. Contact Grundfos for further information.

### 6.4 Installation altitude

Installation altitude is the height above sea level of the installation site. The motors can be installed up to 11,482 feet (3500 m) above sea level.

Motors installed up to 3280 feet (1000 m) above sea level can be loaded 100 %.



Motors installed more than 3280 feet (1000 m) above sea level must not be fully loaded due to the low density and consequent low cooling effect of the air.

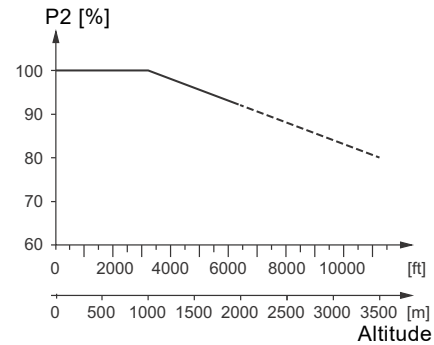

Fig. 13 Motor output power in relation to altitude

In order to maintain the galvanic isolation and ensure correct clearance according to EN 60664-1:2007, you must adapt the supply voltage to the altitude:

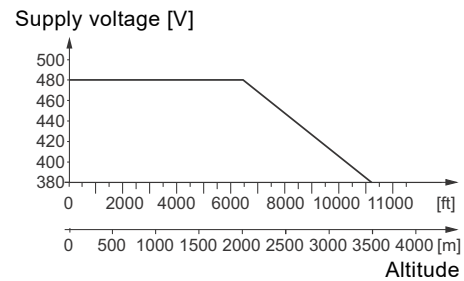

Fig. 14 Supply voltage for three-phase motor in relation to altitude

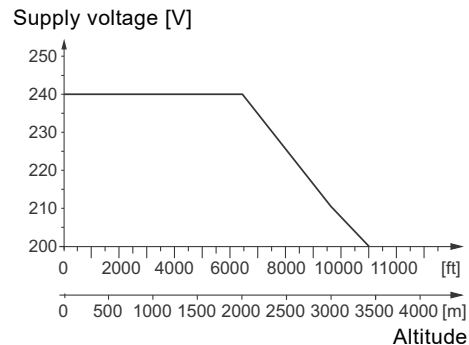

Fig. 15 Supply voltage for single-phase motor in relation to altitude

TM07 1696 2118

TM07 1697 2118

TM07 1698 2118

## 6.5 Humidity

Maximum humidity: 95 %.

If the humidity is constantly high and above 85 %, one of the drain holes in the drive-end flange must be open. See section [4.6 Drain holes](#).

## 6.6 Motor cooling

To ensure cooling of motor and electronics, observe the following:

- Position the motor in such a way that adequate cooling is ensured. See section [4.4 Ensuring motor cooling](#).
- The temperature of the cooling air must not exceed 122 °F (50 °C) (for 3 x 380-500 V), or 104 °F (40 °C) (for 1 x 200-230 V or 3 x 200-240 V).
- Keep cooling fins and fan blades clean.

## 7. User interfaces

### WARNING



#### Hot surface

Death or serious personal injury

- Only touch the buttons on the display as the product may be very hot.

### WARNING



#### Electric shock

Death or serious personal injury

- If the control panel is cracked or perforated, replace it immediately. Contact the nearest Grundfos sales company.

You can make the pump settings by means of the following user interfaces:

#### Control panels

- Standard control panel.  
See section [8. Standard control panel](#).
- Advanced control panel.  
See section [9. Advanced control panel](#).

#### Remote controls

- Grundfos GO.  
See section [10. Grundfos GO](#).

If the power supply to the pump is switched off, the settings are stored.

## 8. Standard control panel

Pump variant	Fitted as standard	Option
NBE, NBSE, NKE, TPE, TPED	-	•
NBE, NBSE, NKE, TPE, TPED Series 2000	-	-

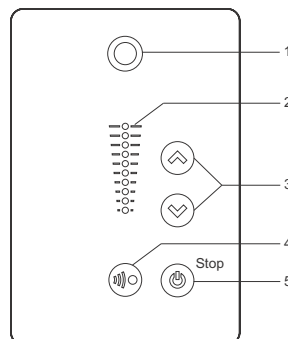

Fig. 16 Standard control panel

TM05 4848 3512

Pos.	Symbol	Description
1		Grundfos Eye Shows the operating status of the pump. See section <a href="#">15. Grundfos Eye</a> for further information.
2	-	Light fields for indication of setpoint.
3		Up and down. Changes the setpoint.
4		Allows radio communication with Grundfos GO and other products of the same type. When you try to establish radio communication between the pump and Grundfos GO or another pump, the green indicator light in Grundfos Eye on the pump flashes continuously. Press  on the pump control panel to allow radio communication with Grundfos GO and other products of the same type.
5		Makes the pump ready for operation as well as starts and stops the pump. <b>Start</b> If you press the button when the pump is stopped, the pump only starts if no other functions with higher priority have been enabled. See section <a href="#">14. Priority of settings</a> . <b>Stop</b> If you press the button when the pump is running, the pump always stops. The "Stop" text next to the button is on.

## 8.1 Setpoint setting

Set the desired setpoint of the pump by pressing  $\odot$  or  $\ominus$ . The light fields on the control panel indicates the setpoint set.

### 8.1.1 Pump in differential-pressure control mode

The following example applies to a pump in an application where a pressure sensor gives a feedback to the pump. If you retrofit the sensor to the pump, set it manually as the pump does not automatically register a connected sensor.

Figure 17 shows that the light fields 5 and 6 are activated, indicating a desired setpoint of 3 m with a sensor measuring range from 0 to 6 m. The setting range is equal to the sensor measuring range.

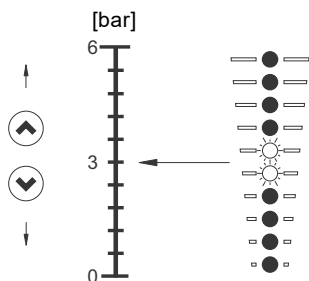

Fig. 17 Setpoint set to 3 m, differential-pressure control

### 8.1.2 Pump in constant-curve control mode

In constant-curve control mode, the pump performance lies between the maximum and minimum curve of the pump. See fig. 18.

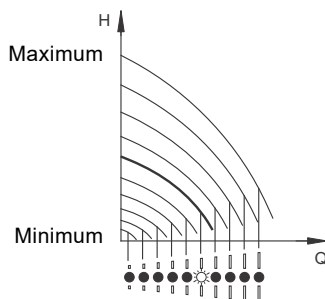

Fig. 18 Pump in constant-curve control mode

Setting to maximum curve:

- Press  $\odot$  continuously to change over to the maximum curve of the pump. The top light field flashes. When the top light field is on, press  $\odot$  for 3 seconds until the light field starts flashing.
- To change back, press  $\ominus$  continuously until the desired setpoint is indicated.

#### Example

Pump set to maximum curve.

Figure 19 shows that the top light field is flashing, indicating maximum curve.

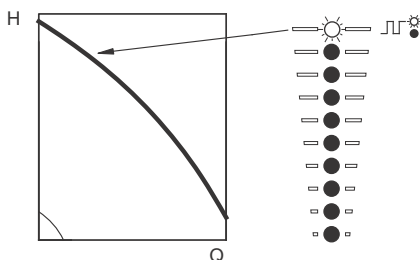

Fig. 19 Maximum-curve duty

Setting to minimum curve:

- Press  $\ominus$  continuously to change over to the minimum curve of the pump. The bottom light field flashes. When the bottom light field is on, press  $\ominus$  for 3 seconds until the light field starts flashing.
- To change back, press  $\odot$  continuously until the desired setpoint is indicated.

#### Example

Pump set to minimum curve.

Figure 20 shows that the bottom light field is flashing, indicating minimum curve.

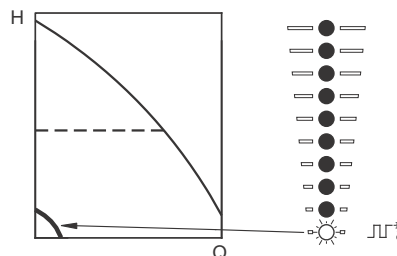

Fig. 20 Minimum-curve duty

### 8.1.3 Start-stop of pump



If you have stopped the pump by pressing  $\odot$  and the "Stop" text on the control panel is on, you can only give it free to operation by pressing  $\odot$  again.

If you have stopped the pump by pressing  $\ominus$ , you can restart it by pressing  $\odot$  or by using Grundfos GO.

Start the pump by pressing  $\odot$  or by continuously pressing  $\odot$  until the desired setpoint is indicated.

Stop the pump by pressing  $\odot$ . When the pump is stopped, the "Stop" text next to the button is on. You can also stop the pump by continuously pressing  $\ominus$  until none of the light fields are on.

You can also stop the pump with the Grundfos GO or via a digital input set to External stop. See section 14. [Priority of settings](#).

### 8.1.4 Resetting of fault indications

Reset a fault indication in one of the following ways:

- Via the digital input if it has been set to Alarm resetting.
- Briefly press  $\odot$  or  $\ominus$  on the pump. This does not change the setting of the pump. You cannot reset a fault indication by pressing  $\odot$  or  $\ominus$  if the buttons have been locked.
- Switch off the power supply until the indicator lights are off.
- Switch the external start-stop input off and on.
- With Grundfos GO.

TM05 4894 3512

TM05 4895 2812

TM05 4896 2812

TM05 4897 2812

## 9. Advanced control panel

Pump variant	Fitted as standard	Option
NBE, NBSE, NKE, TPE, TPED	•	-
NBE, NBSE, NKE, TPE, TPED Series 2000	•	-

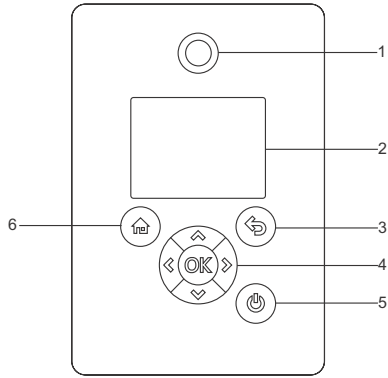

TM05 4849 1013

Fig. 21 Advanced control panel

Pos.	Symbol	Description
1		Grundfos Eye Shows the operating status of the pump. For further information, see section <a href="#">15. Grundfos Eye</a> .
2	-	Graphical colour display.
3		Goes one step back.
		Navigates between main menus, displays and digits. When you change the menu, the display always shows the top display of the new menu.
4		Navigates between submenus. Changes value settings. <b>Note:</b> If you have disabled the possibility to make settings with the Enable/disable settings function, then you can enable it again temporarily by pressing these buttons simultaneously for at least 5 seconds. See section <a href="#">11.28 "Buttons on product" (Enable/disable settings)</a> .
4		Saves changed values, resets alarms and expands the value field. Enables radio communication with Grundfos GO and other products of the same type. When you try to establish radio communication between the pump and Grundfos GO or another pump, the green indicator light in Grundfos Eye flashes. A note also appears in the pump display stating that a wireless device wants to connect to the pump. Press  on the pump control panel to allow radio communication with Grundfos GO and other products of the same type.

Pos.	Symbol	Description
5		Makes the pump ready for operation and starts, and stops the pump. <b>Start:</b> If you press the button when the pump is stopped, the pump only starts if no other functions with higher priority have been enabled. See section <a href="#">14. Priority of settings</a> . <b>Stop:</b> If you press the button when the pump is running, the pump is always stopped. When you stop the pump via this button, the  icon appears in the bottom of the display.
6		Goes to the Home menu.

## 9.1 Home display

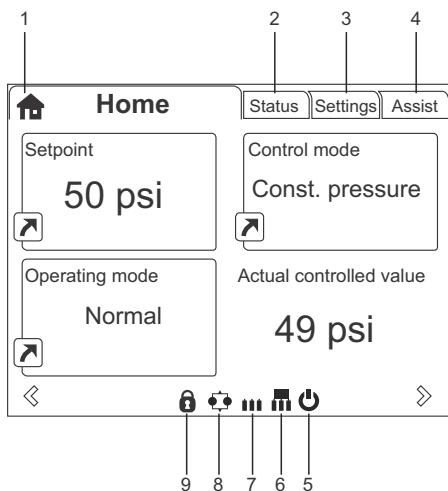











Fig. 22 Example of Home display

Pos.	Symbol	Description
1		Home This menu shows up to four user-defined parameters. You can select parameters shown as shortcut icon  , and when pressing  you go directly to the "Settings" display for the selected parameter.
2	-	Status This menu shows the status of the pump and system as well as warnings and alarms.
3	-	Settings This menu gives access to all setting parameters. You can make detailed settings of the pump in this menu. See section <a href="#">11. Description of functions.</a>
4	-	Assist This menu enables assisted pump setup, provides a short description of the control modes and offers fault advice. See section <a href="#">12. Selection of control mode.</a>
5		Indicates that the pump has been stopped via the  button.
6		Indicates that the pump is functioning as master pump in a multipump system.
7		Indicates that the pump is functioning as a slave pump in a multipump system.
8		Indicates that the pump is operating in a multipump system. See section <a href="#">11.43 "Multipump setup" (Setup of multi-pump system).</a>
9		Indicates that the possibility to make settings has been disabled for protective reasons. See section <a href="#">11.28 "Buttons on product" (Enable/disable settings).</a>

## 9.2 Startup guide

The pump incorporates a startup guide which is started at the first startup. See section [11.37 Run start-up guide](#). After the startup guide, the main menus appear in the display.

## 9.3 Menu overview for advanced control panel

### 9.3.1 Main menus

Home	NBE, NBSE, NKE, TPE, TPED	NBE, NBSE, NKE, TPE, TPED Series 2000	Multipump system
	•	•	•
Status	NBE, NBSE, NKE, TPE, TPED	NBE, NBSE, NKE, TPE, TPED Series 2000	Multipump system
Operating status	•	•	•
Operating mode, from	•	•	•
Control mode	•	•	•
Pump performance	•	•	•
Actual controlled value	•	•	•
Resulting setpoint	•	•	•
Speed	•	•	•
Acc. flow and specific energy	•	•	•
Power and energy consumption	•	•	•
Measured values	•	•	•
Set date and time	•	•	•
Analog input 1	•	•	•
Analog input 2	•	•	•
Analog input 3	•	•	•
Pt100/1000 input 1	•	•	•
Pt100/1000 input 2	•	•	•
Analog output	•	•	•
Warning and alarm	•	•	•
Actual warning or alarm	•	•	•
Warning log	•	•	•
Alarm log	•	•	•
Operating log	•	•	•
Operating hours	•	•	•
Trend data	•	•	•
Fitted modules	•	•	•
Date and time	•	•	•
Product identification	•	•	•
Motor bearing monitoring	•	•	•
Multi-pump system	-	-	•
System operating status	-	-	•
System performance	-	-	•
System input power and energy	-	-	•
Pump 1, multi-pump system	-	-	•
Pump 2, multi-pump system	-	-	•
Pump 3, multi-pump system	-	-	•
Pump 4, multi-pump system	-	-	•

Settings	NBE, NBSE, NKE, TPE, TPED	NBE, NBSE, NKE, TPE, TPED Series 2000	Multipump system	Section	Page
Setpoint	•	•	•	<a href="#">11.1 Setpoint</a>	24
Operating mode	•	•	•	<a href="#">11.2 Operating mode</a>	24
Set manual speed	•	•	•	<a href="#">11.3 Set manual speed</a>	24
"Set user-defined speed"	•	•	•	<a href="#">11.4 "Set user-defined speed"</a>	24
Control mode	•	•	•	<a href="#">11.5 "Control mode"</a>	24
Analog inputs	•	•	•		
Analog input 1, setup	•	•	•	<a href="#">11.7 Analog inputs</a>	29
Analog input 2, setup	•	•	•		
Analog input 3, setup	•	•	•		
Built-in Grundfos sensor	-	•	•*	<a href="#">11.8 Built-in Grundfos sensor</a>	30
Pt100/1000 inputs	•	•	•		
Pt100/1000 input 1, setup	•	•	•	<a href="#">11.9 Pt100/1000 inputs</a>	30
Pt100/1000 input 2, setup	•	•	•		
Digital inputs	•	•	•		
Digital input 1, setup	•	•	•	<a href="#">11.10 Digital inputs</a>	31
Digital input 2, setup	•	•	•		
Digital inputs/outputs	•	•	•		
Digital input/output 3, setup	•	•	•	<a href="#">11.11 Digital inputs/outputs</a>	32
Digital input/output 4, setup	•	•	•		
Relay outputs	•	•	•		
Relay output 1	•	•	•	<a href="#">11.12 "Signal relays 1 and 2" (Relay outputs)</a>	33
Relay output 2	•	•	•		
Analog output	•	•	•		
Output signal	•	•	•	<a href="#">11.13 Analog output</a>	33
Function of analog output	•	•	•		
"Controller settings"	•	•	•	<a href="#">11.14 "Controller" ("Controller settings")</a>	34
Operating range	•	•	•	<a href="#">11.15 Operating range</a>	36
Setpoint influence	•	•	•		
External setpoint function	•	•	•		36
"Predefined setpoints"	•	•	•	<a href="#">11.16.2 "Predefined setpoints"</a>	38
Monitoring functions	•	•	•		
Motor bearing monitoring	•	•	•	<a href="#">11.21 Motor bearing monitoring</a>	40
Motor bearing maintenance	•	•	•	<a href="#">Bearings replaced (Motor bearing maintenance)</a>	40
Limit-exceeded function	•	•	•	<a href="#">11.17 Limit-exceeded function</a>	38
"Special functions"	•	•	•		
"Pulse flowmeter setup"	•	•	•	<a href="#">11.18 "Pulse flowmeter setup"</a>	39
"Ramps"	•	•	•	<a href="#">11.19 "Ramps"</a>	39
"Standstill heating"	•	•	•	<a href="#">11.20 "Standstill heating"</a>	39
Communication	•	•	•		
Pump number	•	•	•	<a href="#">11.23 "Number" (Pump number)</a>	40
Enable/disable radio comm.	•	•	•	<a href="#">11.24 "Radio communication" (Enable/disable radio comm.)</a>	40
General settings	•	•	•		
Language	•	•	•	<a href="#">11.25 Language</a>	40
Set date and time	•	•	•	<a href="#">11.26 "Date and time" (Set date and time)</a>	40
Units	•	•	•	<a href="#">11.27 "Unit configuration" (Units)</a>	40
Enable/disable settings	•	•	•	<a href="#">11.28 "Buttons on product" (Enable/disable settings)</a>	41
Delete history	•	•	•	<a href="#">11.29 Delete history</a>	41
Define Home display	•	•	•	<a href="#">11.30 Define Home display</a>	41

Settings	NBE, NBSE, NKE, TPE, TPED	NBE, NBSE, NKE, TPE, TPED Series 2000	Multipump system	Section	Page
Display settings	•	•	•	<a href="#">11.31 Display settings</a>	41
Store actual settings	•	•	•	<a href="#">11.32 "Store settings" (Store actual settings)</a>	41
Recall stored settings	•	•	•	<a href="#">11.33 "Recall settings" (Recall stored settings)</a>	41
Run start-up guide	•	•	•	<a href="#">11.37 Run start-up guide</a>	42

\* Applies only to a multipump system with NBE, NBSE, NKE, TPE, TPED Series 2000 pumps.

Assist	NBE, NBSE, NKE, TPE, TPED	NBE, NBSE, NKE, TPE, TPED Series 2000	Multipump system	Section	Page
Assisted pump setup	•	•	•	<a href="#">11.41 Assisted pump setup</a>	43
Setup, analog input	•	•	•	<a href="#">11.42 Setup, analog input</a>	43
Setting of date and time	•	•	•	<a href="#">11.43 "Multipump setup" (Setup of multi-pump system)</a>	43
Setup of multi-pump system	•	•	•	<a href="#">11.43 "Multipump setup" (Setup of multi-pump system)</a>	43
Description of control mode	•	•	•	<a href="#">11.44 Description of control mode</a>	46
Assisted fault advice	•	•	•	<a href="#">11.45 Assisted fault advice</a>	46

## 10. Grundfos GO

The pump is designed for wireless radio or infrared communication with Grundfos GO.

Grundfos GO enables setting of functions and gives access to status overviews, technical product information and actual operating parameters.

Grundfos GO offers the following mobile interfaces (MI).

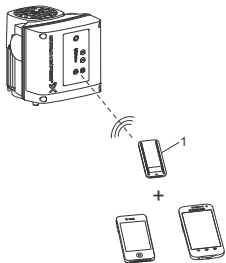



**Fig. 23** Grundfos GO communicating with the pump via radio or infrared connection, IR

TM06 6256 09 16

Pos.	Description
1	Grundfos MI 301: Separate module enabling radio or infrared communication. You can use the module in conjunction with an Android or iOS-based smart device with Bluetooth connection.

### 10.1 Communication



When Grundfos GO initiates communication with the pump, the indicator light in the middle of Grundfos Eye flashes green. See section 15. *Grundfos Eye*.

Furthermore, on pumps fitted with an advanced control panel a text appears in the display saying that a wireless device is trying to establish connection. Press  on the pump in order to establish connection with Grundfos GO or press  to reject connection.

Establish communication using one of these communication types:

- radio communication
- infrared communication.

#### 10.1.1 Radio communication

Radio communication can take place at distances up to 30 m. The first time Grundfos GO communicates with the pump, you must enable communication by pressing  or  on the pump control panel. Later when communication takes place, the pump is recognized by Grundfos GO and you can select the pump from the "List" menu.

#### 10.1.2 Infrared communication

When communicating via infrared light, Grundfos GO must be pointed at the pump control panel.

## 10.2 Menu overview for Grundfos GO

Dashboard	NBE, NBSE, NKE, TPE, TPED	NBE, NBSE, NKE, TPE, TPED Series 2000	Multipump system
	•	•	•
"Status"	NBE, NBSE, NKE, TPE, TPED	NBE, NBSE, NKE, TPE, TPED Series 2000	Multipump system
"System mode"	-	-	•*
"Resulting setpoint"	•	•	
"Resulting system setpoint"	-	-	•*
"Actual controlled value"	•	•	•*
"Motor speed (rpm, %)"	•	•	-
"Power consumption"	•	•	-
"Power cons., sys."	-	-	•*
"Energy consumption"	•	•	
"Energy cons., sys."	-	-	•*
"Acc. flow, specific energy"	•	•	•*
"Operating hours"	•	•	
"Operating hours, system"	-	-	•*
"Analog input 1"	•	•	-
"Analog input 2"	•	•	-
"Analog input 3"	•	•	-
"Pt100/1000 input 1"	•	•	-
"Pt100/1000 input 2"	•	•	-
"Analog output"	•	•	-
"Digital input 1"	•	•	-
"Digital input 2"	•	•	-
"Digital in/output 3"	•	•	-
"Digital in/output 4"	•	•	-
"Fitted modules"	•	•	-
"Pump 1"	-	-	•*
"Pump 2"	-	-	•*
"Pump 3"	-	-	•*
"Pump 4"	-	-	•*

\* Only available if Grundfos GO is connected to a multipump system.

"Settings"	NBE, NBSE, NKE, TPE, TPED	NBE, NBSE, NKE, TPE, TPED Series 2000	Multipump system	Section	Page
"Setpoint"	•	•	•	<a href="#">11.1 Setpoint</a>	24
"Operating mode"	•	•	•	<a href="#">11.2 Operating mode</a>	24
"Set user-defined speed"	•	•	•	<a href="#">11.4 "Set user-defined speed"</a>	24
"Control mode"	•	•	•	<a href="#">11.5 "Control mode"</a>	24
"Proportional-pressure setup"	-	•	-	<a href="#">11.6 "Proportional-pressure setup"</a>	28
"Buttons on product"	•	•	•	<a href="#">11.28 "Buttons on product" (Enable/disable settings)</a>	41
"Controller"	•	•	•	<a href="#">11.14 "Controller" ("Controller settings")</a>	34
"Operating range"	•	•	•	<a href="#">11.15 Operating range</a>	36
"Ramps"	•	•	-	<a href="#">11.19 "Ramps"</a>	39
"Pump number"	•	•	-	<a href="#">11.23 "Number" (Pump number)</a>	40
"Radio communication"	•	•	-	<a href="#">11.24 "Radio communication" (Enable/disable radio comm.)</a>	40
"Analog input 1"	•	•	-	<a href="#">11.7 Analog inputs</a>	29
"Analog input 2"	•	•	-		
"Analog input 3"	•	•	-		
"Built-in Grundfos sensor"	-	•	• <sup>2)</sup>	<a href="#">11.8 Built-in Grundfos sensor</a>	30
"Pt100/1000 input 1"	•	•	-	<a href="#">11.9 Pt100/1000 inputs</a>	30
"Pt100/1000 input 2"	•	•	-		
"Digital input 1"	•	•	-	<a href="#">11.10 Digital inputs</a>	31
"Digital input 2"	•	•	-		
"Digital in/output 3"	•	•	-	<a href="#">11.11 Digital inputs/outputs</a>	32
"Digital in/output 4"	•	•	-		
"Predefined setpoint"	•	•	•	<a href="#">11.16.2 "Predefined setpoints"</a>	38
"Analog output"	•	•	-	<a href="#">11.13 Analog output</a>	33
"External setpoint funct."	•	•	-	<a href="#">11.16.2 "Predefined setpoints"</a>	36
"Signal relay 1"	•	•	-	<a href="#">11.12 "Signal relays 1 and 2" (Relay outputs)</a>	33
"Signal relay 2"	•	•	-		
"Limit 1 exceeded"	•	•	•	<a href="#">11.17 Limit-exceeded function</a>	38
"Limit 2 exceeded"	•	•	•		
"Alternating operation, time"	-	-	• <sup>1)</sup>	<a href="#">11.43 "Multipump setup" (Setup of multi-pump system)</a>	43
"Time for pump changeover"	-	-	• <sup>1)</sup>		
"Standstill heating"	•	•	-	<a href="#">11.20 "Standstill heating"</a>	39
"Motor-bearing monitoring"	•	•	-	<a href="#">11.21 Motor bearing monitoring</a>	40
"Service"	•	•	-	<a href="#">11.22 "Service"</a>	40
"Date and time"	•	•	•	<a href="#">11.26 "Date and time" (Set date and time)</a>	40
"Store settings"	•	•	-	<a href="#">11.32 "Store settings" (Store actual settings)</a>	41
"Recall settings"	•	•	-	<a href="#">11.33 "Recall settings" (Recall stored settings)</a>	41
"Undo"	•	•	•	<a href="#">11.34 "Undo"</a>	41
"Pump name"	•	•	•	<a href="#">11.35 "Pump name"</a>	41
"Connection code"	•	•	•	<a href="#">11.36 "Connection code"</a>	42
"Unit configuration"	•	•	•	<a href="#">11.27 "Unit configuration" (Units)</a>	40

<sup>1)</sup> Only available if Grundfos GO is connected to a multipump system.

<sup>2)</sup> Applies only to a multipump system with NBE, NBSE, NKE, TPE, TPED Series 2000 pumps.

<b>"Alarms and warnings"</b>	<b>NBE, NBSE, NKE, TPE, TPED</b>	<b>NBE, NBSE, NKE, TPE, TPED Series 2000</b>	<b>Multipump system</b>	<b>Section</b>	<b>Page</b>
"Alarm log"	•	•	•	<a href="#">11.38 Alarm log</a>	42
"Warning log"	•	•	•	<a href="#">11.39 Warning log</a>	42
"Reset alarm" button	•	•	•		

<b>"Assist"</b>	<b>NBE, NBSE, NKE, TPE, TPED</b>	<b>NBE, NBSE, NKE, TPE, TPED Series 2000</b>	<b>Multipump system</b>	<b>Section</b>	<b>Page</b>
"Assisted pump setup"	•	•		<a href="#">11.41 Assisted pump setup</a>	43
"Assisted fault advice"	•	•	•	<a href="#">11.45 Assisted fault advice</a>	46
"Multipump setup"	•	•	•	<a href="#">11.43 "Multipump setup" (Setup of multi-pump system)</a>	43

## 11. Description of functions

### 11.1 Setpoint

Pump variant	Setpoint
NBE, NBSE, NKE, TPE, TPED	•
NBE, NBSE, NKE, TPE, TPED Series 2000	•

You can set the setpoint for all control modes in this submenu when you have selected the desired control mode. See section [11.5 "Control mode"](#).

#### Factory setting

See section [28. Factory settings](#).

### 11.2 Operating mode

Pump variant	Operating mode
NBE, NBSE, NKE, TPE, TPED	•
NBE, NBSE, NKE, TPE, TPED Series 2000	•

Possible operating modes:

- Normal  
The pump runs according to the selected control mode.
- Stop  
The pump stops.
- Min.  
Use the minimum-curve mode in periods in which a minimum flow is required.
- Max.  
Use the maximum-curve mode in periods in which a maximum flow is required.  
This operating mode is for instance suitable for systems with hot-water priority.
- Manual  
The pump is operating at a manually set speed. In Manual the setpoint via bus is overruled.  
See section [11.3 Set manual speed](#).
- "User-defined speed"  
The motor is operating at a speed set by the user. See section [11.4 "Set user-defined speed"](#).

All operating modes are illustrated in the figure below.

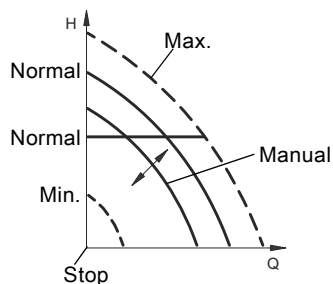

Fig. 24 Operating modes

TM06 4024 1515

### 11.3 Set manual speed

Pump variant	Set manual speed
NBE, NBSE, NKE, TPE, TPED	•
NBE, NBSE, NKE, TPE, TPED Series 2000	•

This menu is only available in the advanced control panel. With Grundfos GO, you set the speed via the Setpoint menu.

You can set the pump speed in % of the maximum speed. When you have set the operating mode to Manual, the pump starts running at the set speed. The speed can then be changed manually via Grundfos GO or via the advanced control panel.

#### Factory setting

See section [28. Factory settings](#).

### 11.4 "Set user-defined speed"

You can set the motor speed in % of the maximum speed. When you have set the operating mode to "User-defined speed", the motor runs at the set speed.

### 11.5 "Control mode"

Pump variant	"Control mode"
NBE, NBSE, NKE, TPE, TPED	•
NBE, NBSE, NKE, TPE, TPED Series 2000	•

Possible control modes:

- Prop. pressure (proportional pressure)
- Const. pressure (constant pressure)
- Const. temp. (constant temperature)
- Con. diff. press. (constant differential pressure)
- Con. diff. temp. (constant differential temperature)
- Const. flow rate (constant flow rate)
- Const. level (constant level)
- Const. other val. (constant other value)
- Const. curve (constant curve).



The operating mode must be set to Normal before a control mode can be enabled.

#### Factory setting

See section [28. Factory settings](#).

### 11.5.1 "Proportional pressure"

Pump variant	"Proportional pressure"
NBE, NBSE, NKE, TPE, TPED	-
NBE, NBSE, NKE, TPE, TPED Series 2000	•

The head of the pump is reduced at decreasing water demand and increased at rising water demand. See fig. 25.

This control mode is especially suitable in systems with relatively large pressure losses in the distribution pipes. The head of the pump increases proportionally to the flow in the system to compensate for the large pressure losses in the distribution pipes.

The setpoint can be set with an accuracy of 0.1 metre. The head against a closed valve is half the setpoint.

For more information about settings, see section [11.6 "Proportional-pressure setup"](#).

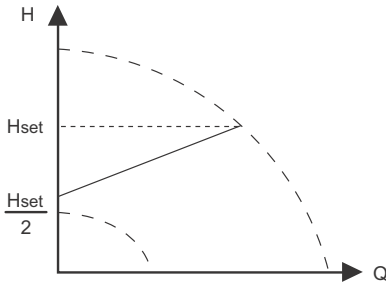

Fig. 25 "Proportional pressure"

#### Example

- Factory-fitted differential-pressure sensor.

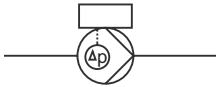

Fig. 26 "Proportional pressure"

#### Controller settings

For recommended controller settings, see section [11.14 "Controller" \("Controller settings"\)](#)

### 11.5.2 "Constant pressure"

Pump variant	"Constant pressure"
NBE, NBSE, NKE, TPE, TPED	•
NBE, NBSE, NKE, TPE, TPED Series 2000	•

We recommend this control mode if the pump is to deliver a constant pressure, independently of the flow in the system. The pump maintains a constant pressure independently of the flow rate. See fig. 27.

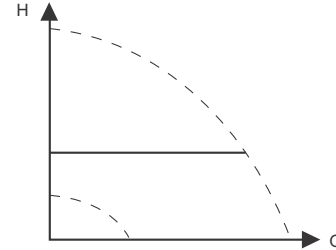

Fig. 27 "Constant pressure"

This control mode requires an external pressure sensor as shown in the examples below. You can set the pressure sensor in the Assist menu. See section [11.41 Assisted pump setup](#).

#### Examples

- One external pressure sensor.

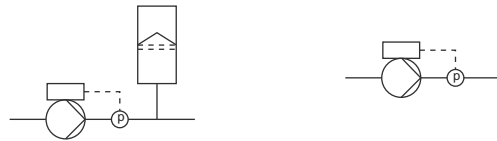

Fig. 28 "Constant pressure"

#### Controller settings

For recommended controller settings, see section [11.14 "Controller" \("Controller settings"\)](#).

TM05 7909 1613

TM05 7901 1613

### 11.5.3 "Constant temperature"

Pump variant	"Constant temperature"
NBE, NBSE, NKE, TPE, TPED	•
NBE, NBSE, NKE, TPE, TPED Series 2000	•

This control mode ensures a constant temperature. Constant temperature is a comfort control mode that you can use in domestic hot-water systems to control the flow to maintain a constant temperature in the system. See fig. 29.

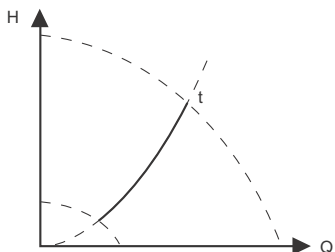

Fig. 29 "Constant temperature"

This control mode requires an external temperature sensor. See the examples below.

#### Examples

- One external temperature sensor.



Fig. 30 "Constant temperature"

#### Controller settings

For recommended controller settings, see section 11.14 "Controller" ("Controller settings").

### 11.5.4 "Constant differential pressure"

Pump variant	"Constant differential pressure"
NBE, NBSE, NKE, TPE, TPED	•
NBE, NBSE, NKE, TPE, TPED Series 2000	•

The pump maintains a constant differential pressure, independently of the flow in the system. See fig. 31. This control mode is primarily suitable for systems with relatively small pressure losses.

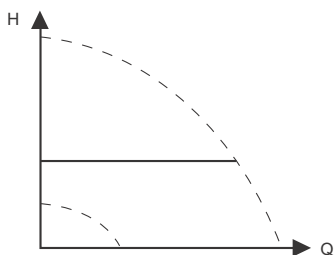
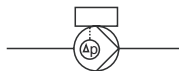

Fig. 31 "Constant differential pressure"

This control mode requires either an internal or external differential-pressure sensor or two external pressure sensors. See the examples below.

#### Examples

- Factory-fitted differential-pressure sensor, only NBE, NBSE, NKE, TPE, TPED Series 2000.



- One external differential-pressure sensor. The pump uses the input from the sensor to control the differential pressure. You can set the sensor manually or by using the Assist menu. See section 11.41 Assisted pump setup.

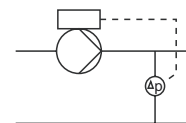
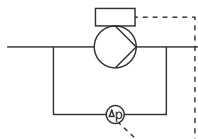

- Two external pressure sensors. Constant differential-pressure control is achievable with two pressure sensors. The pump uses the inputs from the two sensors and calculates the differential pressure. The sensors must have the same unit and must be set as feedback sensors. You can set the sensors manually, sensor by sensor, or by using the Assist menu. See section 11.41 Assisted pump setup.

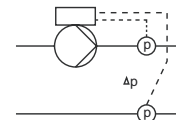
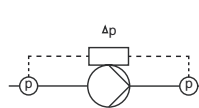

Fig. 32 "Constant differential pressure"

#### Controller settings

For recommended controller settings, see section 11.14 "Controller" ("Controller settings").

11.5.5 "Constant differential temperature"

Pump variant	"Constant differential temperature"
NBE, NBSE, NKE, TPE, TPED	•
NBE, NBSE, NKE, TPE, TPED Series 2000	•

The pump maintains a constant differential temperature in the system and the pump performance is controlled according to this. See fig. 33.

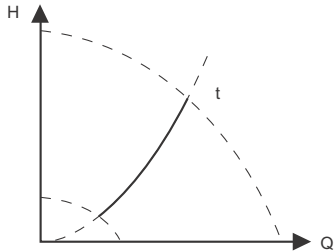

TM05 7954 1713

Fig. 33 "Constant differential temperature"

This control mode requires either two external temperature sensors or one external differential-temperature sensor. See the examples below.

Examples

- Two external temperature sensors.

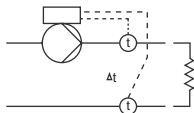

- One external differential-temperature sensor.

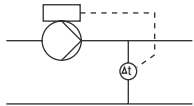

Fig. 34 "Constant differential temperature"

Controller settings

For recommended controller settings, see section 11.14 "Controller" ("Controller settings").

11.5.6 "Constant flow rate"

Pump variant	"Constant flow rate"
NBE, NBSE, NKE, TPE, TPED	•
NBE, NBSE, NKE, TPE, TPED Series 2000	•

The pump maintains a constant flow in the system, independently of the head. See fig. 35.

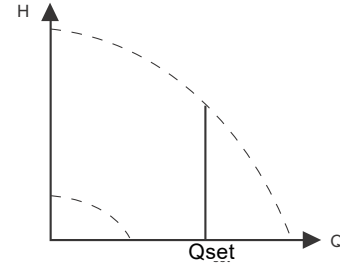

TM05 7955 1713

Fig. 35 "Constant flow rate"

This control mode requires an external flow sensor. See the example below.

Example

- One external flow sensor.

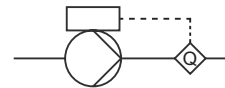

Fig. 36 "Constant flow rate"

Controller settings

For recommended controller settings, see section 11.14 "Controller" ("Controller settings").

11.5.7 "Constant level"

Pump variant	"Constant level"
NBE, NBSE, NKE, TPE, TPED	•
NBE, NBSE, NKE, TPE, TPED Series 2000	•

The pump maintains a constant level, independently of the flow rate. See fig. 37.

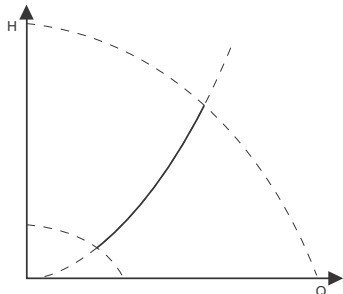

Fig. 37 "Constant level"

This control mode requires an external level sensor. The pump can control the level in a tank in two ways:

- as an emptying function where the pump draws the liquid from the tank.
- as a filling function where the pump pumps the liquid into the tank.

See fig. 38.

The type of level control function depends on the setting of the built-in controller. See section 11.14 "Controller" ("Controller settings").

Examples

- One external level sensor.
  - emptying function.

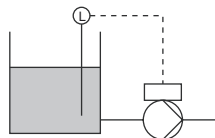

- One external level sensor.
  - filling function.

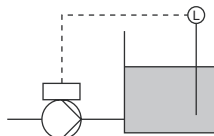

Fig. 38 "Constant level"

Controller settings

For recommended controller settings, see section 11.14 "Controller" ("Controller settings").

11.5.8 "Constant other value"

Pump variant	"Constant other value"
NBE, NBSE, NKE, TPE, TPED	•
NBE, NBSE, NKE, TPE, TPED Series 2000	•

Any other value is kept constant.

11.5.9 "Constant curve"

Pump variant	"Constant curve"
NBE, NBSE, NKE, TPE, TPED	•
NBE, NBSE, NKE, TPE, TPED Series 2000	•

You can set the pump to operate according to a constant curve, like an uncontrolled pump. See fig. 39.

You can set the desired speed in % of the maximum speed in the range from 25 to 100 % (110 %).

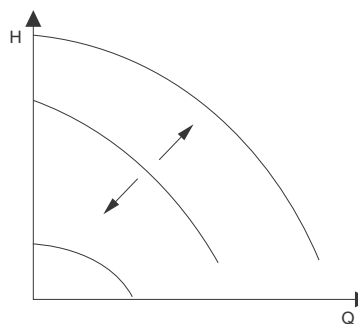

Fig. 39 "Constant curve"

Controller settings

For recommended controller settings, see section 11.14 "Controller" ("Controller settings").

11.6 "Proportional-pressure setup"

Pump variant	"Proportional-pressure setup"
NBE, NBSE, NKE, TPE, TPED	-
NBE, NBSE, NKE, TPE, TPED Series 2000	•

"Control-curve function"

You can set the curve either to quadratic or linear.

"Zero-flow head"

You can set this value in % of the setpoint. With a setting of 100 %, the control mode is equal to constant differential pressure.

## 11.7 Analog inputs

Pump variant	Analog inputs
NBE, NBSE, NKE, TPE, TPED	•
NBE, NBSE, NKE, TPE, TPED Series 2000	•

Function	Terminal*
Analog input 1, setup	4
Analog input 2, setup	7
Analog input 3, setup	14

\* See section [5.5.1 Connection terminals, advanced functional module, FM 300](#).

Set the analog input for a feedback sensor via the Assisted pump setup menu. See section [11.41 Assisted pump setup](#).

If you want to set an analog input for other purposes, you can do this manually.

You can set the analog inputs via the Setup, analog input menu. See section [11.42 Setup, analog input](#).

If you perform the manual setting via Grundfos GO, you need to enter the menu for the analog input under the Settings menu.

### Function

You can set the analog inputs to these functions:

- Not active.
- Feedback sensor.
- Ext. setpoint infl..  
See section [11.16.1 Setpoint influence](#).
- Other function.

### Measured parameter

Select one of the parameters, such as the parameter to be measured in the system by the sensor connected to the actual analog input. See [fig. 40](#).

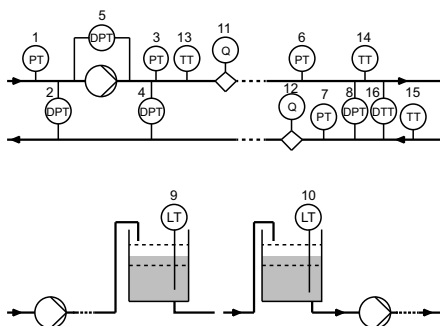

Fig. 40 Overview of sensor locations

Sensor function, measured parameter	Pos.
Inlet pressure	1
Diff. press., inlet	2
Liquid temp.	3
Diff. press.,outlet	4
Diff. press.,pump	5
Operating mode	6
Press. 2, external	7
Diff. press., ext.	8
Storage tank level	9
Feed tank level	10
Pump flow	11
Flow, external	12
Liquid temp.	13
Temperature 1	14
Temperature 2	15
Diff. temp., ext.	16
Ambient temp.	Not shown
Other parameter	Not shown

### Unit

Available measuring units:

Parameter	Possible measuring units
Pressure	bar, m, kPa, psi, ft
Level	m, ft, in
Flow rate	m <sup>3</sup> /h, l/s, yd <sup>3</sup> /h, gpm
Liquid temp.	°C, °F
Other parameter	%

### "Electrical signal"

Select signal type:

- 0.5-3.5 V
- 0-5 V
- 0-10 V
- 0-20 mA
- 4-20 mA.

### Sensor range, minimum value

Set the minimum value of the connected sensor.

### Sensor range, maximum value

Set the maximum value of the connected sensor.

### Factory setting

See section [28. Factory settings](#).

TM06 2328 3914

### 11.7.1 Setting two sensors for differential measurement

In order to measure the difference of a parameter between two points, set the corresponding sensors as follows:

Parameter	Analog input for sensor 1	Analog input for sensor 2
Pressure, option 1	Differential pressure, inlet	Differential pressure, outlet
Pressure, option 2	Pressure 1, external	Pressure 2, external
Flow	Pump flow	Flow, external
Temperature	Temperature 1	Temperature 2



If you want to use the control mode "constant differential pressure", you must choose the function Feedback sensor for the analog input of both sensors.

### 11.8 Built-in Grundfos sensor

Pump variant	Built-in Grundfos sensor
NBE, NBSE, NKE, TPE, TPED	-
NBE, NBSE, NKE, TPE, TPED Series 2000	•

You can select the function of the built-in sensor in the Built-in Grundfos sensor menu.

Set the Built-in Grundfos sensor via the Assisted pump setup menu. See section [11.41 Assisted pump setup](#).

If you perform the setting manually in the advanced control panel, you must enter the Analog inputs menu under the Settings menu in order to access the Built-in Grundfos sensor menu.

If you perform the setting manually via Grundfos GO, you need to enter the menu for the Built-in Grundfos sensor under the Settings menu.

#### Function

You can set the built-in sensor to these functions:

- Grundfos diff.-pressure sensor
  - Not active
  - Feedback sensor
  - Setpoint influence
  - Other function.

#### Factory setting

See section [28. Factory settings](#).

### 11.9 Pt100/1000 inputs

Pump variant	Pt100/1000 inputs
NBE, NBSE, NKE, TPE, TPED	•
NBE, NBSE, NKE, TPE, TPED Series 2000	•

Function	Terminal
Pt100/1000 input 1, setup	17 and 18
Pt100/1000 input 2, setup	18 and 19

\* See section [5.5.1 Connection terminals, advanced functional module, FM 300](#).

Set the Pt100/1000 input for a feedback sensor via the Assisted pump setup menu. See section [11.41 Assisted pump setup](#).

If you want to set a Pt100/1000 input for other purposes, you can do this manually.

You can set the analog inputs via the Setup, analog input menu. See section [11.42 Setup, analog input](#).

If you perform the manual setting via Grundfos GO, you need to enter the menu for the Pt100/1000 input under the Settings menu.

#### Function

You can set the Pt100/1000 inputs to these functions:

- Not active
- Feedback sensor
- Ext. setpoint infl.  
See section [11.16.1 Setpoint influence](#).
- Other function.

#### Measured parameter

Select one of the parameters, such as the parameter to be measured in the system by the Pt100/1000 sensor connected to the actual Pt100/1000 input. See [fig. 41](#).

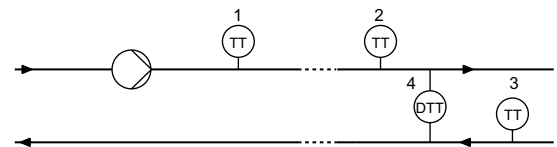

TM06 4012 1515

Fig. 41 Overview of Pt100/1000 sensor locations

Parameter	Pos.
Liquid temp.	1
Temperature 1	2
Temperature 2	3
Ambient temp.	Not shown

#### Measuring range

-58 to 399 °F (-50 to 204 °C).

#### Factory setting

See section [28. Factory settings](#).

## 11.10 Digital inputs

Pump variant	Digital inputs
NBE, NBSE, NKE, TPE, TPED	•
NBE, NBSE, NKE, TPE, TPED Series 2000	•

Function	Terminal*
Digital input 1, setup	2 and 6
Digital input 2, setup	1 and 9

\* See section [5.5.1 Connection terminals, advanced functional module, FM 300](#).

To set a digital input, make the settings below.

### Function

Select one of these functions:

- Not active  
When set to Not active, the input has no function.
- External stop  
When the input is deactivated, open circuit, the pump stops.
- Min. (minimum speed)  
When the input is activated, the pump runs at the set minimum speed.
- Max. (maximum speed)  
When the input is activated, the pump runs at the set maximum speed.
- "User-defined speed"  
When the input is activated, the motor runs at a speed set by the user.
- External fault  
When the input is activated, a timer is started. If the input is activated for more than 5 seconds, the pump stops and a fault is indicated. This function depends on input from external equipment.
- Alarm resetting  
When the input is activated, a possible fault indication is reset.
- Dry running  
When this function has been selected, lack of inlet pressure or water shortage can be detected. When lack of inlet pressure or water shortage, dry running, is detected, the pump stops. The pump cannot restart as long as the input is activated. This requires the use of an accessory, such as:
  - a pressure switch installed on the inlet side of the pump
  - a float switch installed on the inlet side of the pump.
- Accumulated flow  
When this function has been selected, the accumulated flow can be registered. This requires the use of a flowmeter which gives a feedback signal as a pulse per defined flow of water. See section [11.18 "Pulse flowmeter setup"](#).
- Predefined setpoint digit 1, applies only to digital input 2.  
When digital inputs are set to predefined setpoint, the pump operates according to a setpoint based on the combination of the activated digital inputs. See section [11.16.2 "Predefined setpoints"](#).
- Activate output  
When the input is activated, the related digital output is activated. See section [11.11 Digital inputs/outputs](#). This is done without any changes to pump operation.
- Local motor stop  
When the input is activated, the given pump in a multipump system stops without affecting the performance of the other pumps in the system.

The priority of the selected functions in relation to each other appears from section [14. Priority of settings](#).

A stop command always has the highest priority.

### Activation delay

Select the activation delay, T1.

It is the time between the digital signal and the activation of the selected function.

Range: 0 to 6000 seconds.

### Duration timer mode

Select the mode. See fig. [42](#).

- Not active
- active with interrupt, mode A
- active without interrupt, mode B
- active with after-run, mode C.

Select the duration time, T2.

It is the time which, together with the mode, determines how long the selected function is active.

Range: 0 to 15,000 seconds.

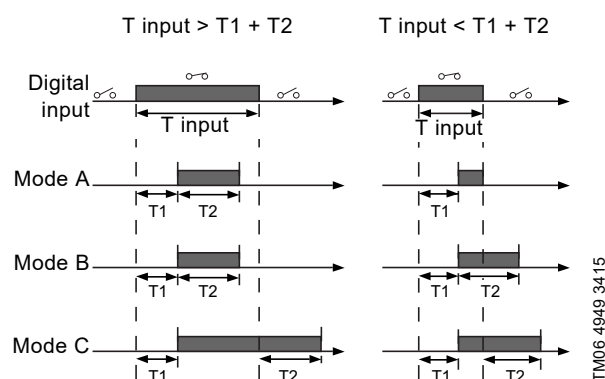

Fig. 42 Duration timer function of digital inputs

### Factory setting

See section [28. Factory settings](#).

TM06 4949 34:15

### 11.11 Digital inputs/outputs

Pump variant	Digital inputs/outputs
NBE, NBSE, NKE, TPE, TPED	•
NBE, NBSE, NKE, TPE, TPED Series 2000	•

Function	Terminal*
Digital input/output 3, setup	10 and 16
Digital input/output 4, setup	11 and 18

\* See section 5.5.1 Connection terminals, advanced functional module, FM 300.

You can select if the interface must be used as input or output. The output is an open collector and you can connect it to for example an external relay or controller such as a PLC.

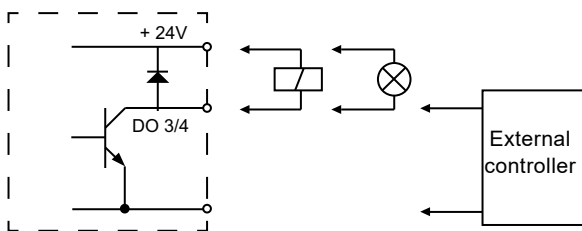

Fig. 43 Example of configurable digital inputs or outputs

To set a digital input or output, make the settings below.

#### Mode

You can set the digital input or output 3 and 4 to act as digital input or digital output:

- Digital input
- Digital output.

#### Function

You can set the digital input or output 3 and 4 to these functions:

#### Possible functions, digital input or output 3

Function if input See details in section 11.10 Digital inputs	Function if output See details in section 11.12 "Signal relays 1 and 2" (Relay outputs)
• Not active	• Not active
• External stop	• Ready
• Min.	• Alarm
• Max.	• Operation
• "User-defined speed"	• Pump running
• External fault	• Warning
• Alarm resetting	• Limit 1 exceeded
• Dry running	• Limit 2 exceeded
• Accumulated flow	• "Digital input 1, state"
• "Predefined setpoint digit 2"	• "Digital input 2, state"
• "Activate output"	• "Digital input 3, state"
• "Local motor stop"	• "Digital input 4, state"

### Possible functions, digital input or output 4

Function if input See details in section 11.10 Digital inputs	Function if output See details in section 11.12 "Signal relays 1 and 2" (Relay outputs)
• Not active	• Not active
• External stop	• Ready
• Min.	• Alarm
• Max.	• Operation
• "User-defined speed"	• Pump running
• External fault	• Warning
• Alarm resetting	• Limit 1 exceeded
• Dry running	• Limit 2 exceeded
• Accumulated flow	• "Digital input 1, state"
• "Predefined setpoint digit 3"	• "Digital input 2, state"
• "Activate output"	• "Digital input 3, state"
• "Local motor stop"	• "Digital input 4, state"

#### Activation delay

Select the activation delay, T1.

It is the time between the digital signal and the activation of the selected function.

Range: 0 to 6000 seconds.

#### Duration timer mode

Select the mode. See fig. 42.

- Not active
- active with interrupt, mode A
- active without interrupt, mode B
- active with after-run, mode C.

Select the duration time, T2.

It is the time which, together with the mode, determines how long the selected function is active.

Range: 0 to 15,000 seconds.

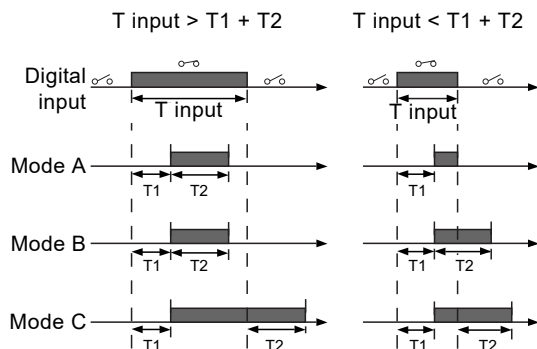

Fig. 44 Duration timer function of digital inputs

#### Factory setting

See section 28. Factory settings.

## 11.12 "Signal relays 1 and 2" (Relay outputs)

Pump variant	"Signal relays 1 and 2"
NBE, NBSE, NKE, TPE, TPED	•
NBE, NBSE, NKE, TPE, TPED Series 2000	•

Function	Terminal*
Relay output 1	NC, C1, NO
Relay output 2	NC, C2, NO

\* See section [5.5.1 Connection terminals, advanced functional module, FM 300](#).

The pump incorporates two signal relays for potential-free signalling. For further information, see section [16. Signal relays](#).

### Function

You can configure the signal relays to be activated by one of the following incidents:

- Not active.
- Ready  
The pump can be running or is ready to run and no alarms are present.
- Alarm  
There is an active alarm and the pump is stopped.
- "Operating" (Operation)  
"Operating" equals "Running" but the pump is still in operation when it has been stopped due to a warning.
- "Running" (Pump running)
- Warning  
There is an active warning.
- "Digital input 1, state"  
Follows digital input 1. If digital input 1 is activated, output is also activated.
- "Digital input 2, state"  
Follows digital input 2. If digital input 2 is activated, output is also activated.
- "Digital input 3, state"  
Follows digital input 3. If digital input 3 is activated, output is also activated.
- "Digital input 4, state"  
Follows digital input 4. If digital input 4 is activated, output is also activated.
- Limit 1 exceeded  
When the Limit 1 exceeded function is activated, the signal relay is activated. See section [11.17 Limit-exceeded function](#).
- Limit 2 exceeded  
When the Limit 2 exceeded function is activated, the signal relay is activated. See section [11.17 Limit-exceeded function](#).
- Relubricate
- "External fan control" (Control of external fan)  
When you select "External fan control", the relay is activated if the internal temperature of the motor electronics reach a preset limit value.

### Factory setting

See section [28. Factory settings](#).

## 11.13 Analog output

Pump variant	Analog output
NBE, NBSE, NKE, TPE, TPED	•
NBE, NBSE, NKE, TPE, TPED Series 2000	•

Function	Terminal*
Analog output	12

\* See section [5.5.1 Connection terminals, advanced functional module, FM 300](#).

The analog output enables the transfer of certain operating data to external control systems.

To set the analog output, make the settings below.

### Output signal

- 0-10 V
- 0-20 mA
- 4-20 mA.

### Function of analog output

- Actual speed.

Signal range [V, mA]	Actual speed [%]		
	0	100	200
0-10 V	0 V	5 V	10 V
0-20 mA	0 mA	10 mA	20 mA
4-20 mA	4 mA	12 mA	20 mA

The reading is a percentage of nominal speed.

- Actual value

Signal range [V, mA]	Actual value	
	Sensor <sub>min</sub>	Sensor <sub>max</sub>
0-10 V	0 V	10 V
0-20 mA	0 mA	20 mA
4-20 mA	4 mA	20 mA

The reading is a percentage of the range between sensor<sub>min</sub> and sensor<sub>max</sub>.

- Resulting setpoint

Signal range [V, mA]	Resulting setpoint [%]	
	0	100
0-10 V	0 V	10 V
0-20 mA	0 mA	20 mA
4-20 mA	4 mA	20 mA

The reading is a percentage of the external setpoint range.

- Motor load

Signal range [V, mA]	Motor load [%]	
	0	100
0-10 V	0 V	10 V
0-20 mA	0 mA	20 mA
4-20 mA	4 mA	20 mA

The reading is a percentage of the range between 0 and 100 % of the maximum permissible load at the actual speed.

- Motor current

Signal range [V, mA]	Motor current [%]		
	0	100	200
0-10 V	0 V	5 V	10 V
0-20 mA	0 mA	10 mA	20 mA
4-20 mA	4 mA	12 mA	20 mA

The reading is a percentage of the range between 0 and 100 % of the rated current.

- Limit 1 exceeded and Limit 2 exceeded

Signal range [V, mA]	Limit-exceeded function	
	Output not active	Output active
0-10 V	0 V	10 V
0-20 mA	0 mA	20 mA
4-20 mA	4 mA	20 mA

The Limit-exceeded function is typically used for monitoring of secondary parameters in the system. If the limit is exceeded, an output, warning or alarm is activated.

- Flow rate

Signal range [V, mA]	Flow rate [%]		
	0	100	200
0-10 V	0 V	5 V	10 V
0-20 mA	0 mA	10 mA	20 mA
4-20 mA	4 mA	12 mA	20 mA

The reading is a percentage of the range between 0 and 100 % of the nominal flow.

#### Factory setting

See section [28. Factory settings](#).

## 11.14 "Controller" ("Controller settings")

Pump variant	"Controller"
NBE, NBSE, NKE, TPE, TPED	•
NBE, NBSE, NKE, TPE, TPED Series 2000	•

The pumps have a factory setting of gain,  $K_p$ , and integral time,  $T_i$ .

However, if the factory setting is not the optimum setting, you can change the gain and the integral time.

- Set the gain within the range from 0.1 to 20.
- Set the integral time within the range from 0.1 to 3600 seconds. If you select 3600 seconds, the controller functions as a P controller.

Furthermore, you can set the controller to inverse control. This means that if the setpoint is increased, the speed is reduced. In the case of inverse control, the gain must be set within the range from -0.1 to -20.

**Guidelines for setting of PI controller**

The tables below show the recommended controller settings:

"Differential-pressure control"	$K_p$	$T_i$
	0.5	0.5
	0.5	L1 < 5 m: 0.5 L1 > 5 m: 3 L1 > 10 m: 5

L1: distance in meters between pump and sensor.

"Temperature control"	$K_p$		$T_i$
	Heating system <sup>1)</sup>	Cooling system <sup>2)</sup>	
	0.5	-0.5	10 + 5L2
	0.5	-0.5	30 + 5L2

- 1) In heating systems, an increase in pump performance results in a rise in temperature at the sensor.
- 2) In cooling systems, an increase in pump performance results in a drop in temperature at the sensor.

L2: distance in meters between heat exchanger and sensor.

"Differential-temperature control"	$K_p$	$T_i$
	-0.5	10 + 5L2

L2: distance in meters between heat exchanger and sensor.

"Flow control"	$K_p$	$T_i$
	0.5	0.5
"Constant pressure control"	$K_p$	$T_i$
	0.5	0.5
	0.1	0.5
"Level control"	$K_p$	$T_i$
	-2.5	100
	2.5	100

**Rules of thumb**

If the controller is too slow-reacting, increase the gain.

If the controller is hunting or unstable, dampen the system by reducing the gain or increasing the integral time.

**Factory setting**

See section 28. *Factory settings*.

### 11.15 Operating range

Pump variant	Operating range
NBE, NBSE, NKE, TPE, TPED	•
NBE, NBSE, NKE, TPE, TPED Series 2000	•

Set the operating range as follows:

- Set the minimum speed within the range from fixed minimum speed to user-set maximum speed.
- Set the maximum speed within the range from user-set minimum speed to fixed maximum speed.

The range between the user-set minimum and maximum speeds is the operating range. See fig. 45.

Speeds below 25 % may result in noise from the shaft seal.

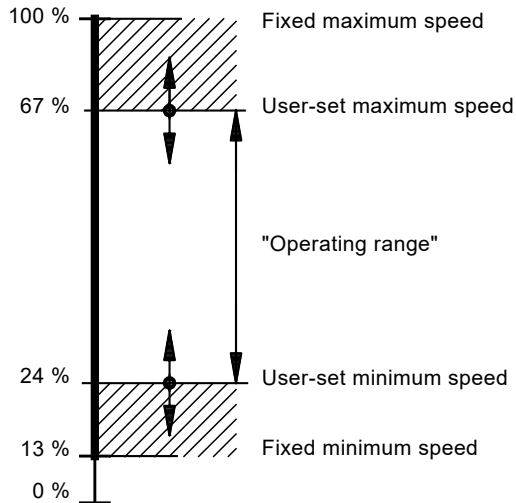

Fig. 45 Example of minimum and maximum settings

#### Factory setting

See section 28. [Factory settings](#).

### 11.16 External setpoint function

Pump variant	External setpoint function
NBE, NBSE, NKE, TPE, TPED	•
NBE, NBSE, NKE, TPE, TPED Series 2000	•

You can influence the setpoint by an external signal, either via one of the analog inputs or, if an advanced functional module is fitted, via one of the Pt100/1000 inputs.



Before you can enable the External setpoint function, you must set one of the analog inputs or Pt100/1000 inputs to Setpoint influence.

See sections 11.7 [Analog inputs](#) and 11.9 [Pt100/1000 inputs](#).

If more than one input has been set to Setpoint influence, the function selects the analog input with the lowest number, for example Setting of pump, and ignores the other inputs, for example Analog input 3 or "Pt100/1000 input 1". Only one input should be used for setpoint influence.

#### Example with constant pressure with linear influence

Actual setpoint: actual input signal x (setpoint - sensor min.) + sensor min.

At a lower sensor value of 0 bar, a setpoint of 2 bar and an external setpoint of 60 %, the actual setpoint is 0.60 x (2 - 0) + 0 = 1.2 bar.

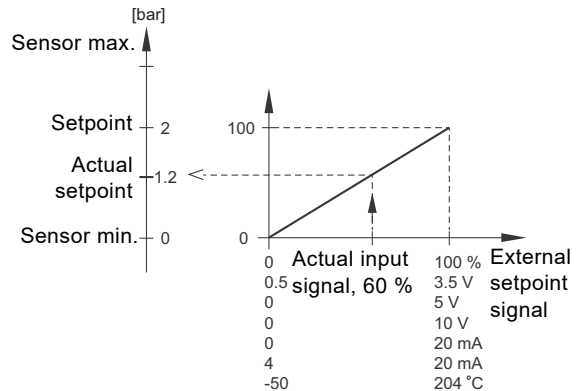

Fig. 46 Example of setpoint influence with sensor feedback

#### Example with constant curve with linear influence

Actual setpoint: actual input signal x (setpoint - user-set minimum speed) + user-set minimum speed.

At a user-set minimum speed of 25 %, a setpoint of 85 % and an external setpoint of 60 %, the actual setpoint is 0.60 x (85 - 25) + 25 = 61 %.

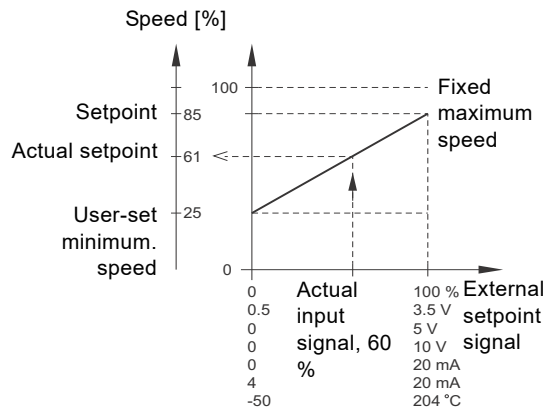

Fig. 47 Example of setpoint influence with constant curve

#### Factory setting

See section 28. [Factory settings](#).

11.16.1 Setpoint influence

Pump variant	Setpoint influence
NBE, NBSE, NKE, TPE, TPED	•
NBE, NBSE, NKE, TPE, TPED Series 2000	•

The table below gives an overview of the types of setpoint influence and the availability depending on pump type.

Setpoint influence	Pump type	
	NBE, NBSE, NKE, TPE, TPED	NBE, NBSE, NKE, TPE, TPED Series 2000
Not active	•	•
Linear function	•	•
Linear with Stop	•	•
Influence table	•	•

You can select these functions:

- Not active  
When set to Not active, the setpoint is not influenced from any external function.
- Linear function  
The setpoint is influenced linearly from 0 to 100 %. See fig. 48.

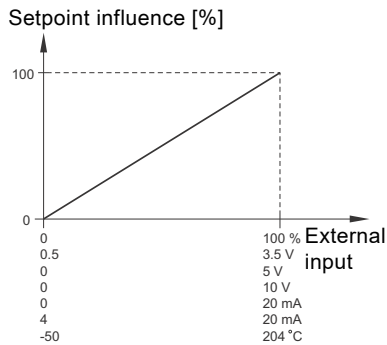

Fig. 48 Linear function

TM06 4166 1615

- Linear with Stop
  - In the input signal range from 20 to 100 %, the setpoint is influenced linearly. If the input signal is below 10 %, the pump changes to operating mode Stop. If the input signal is above 15 %, the operating mode is changed back to Normal. See fig. 49.

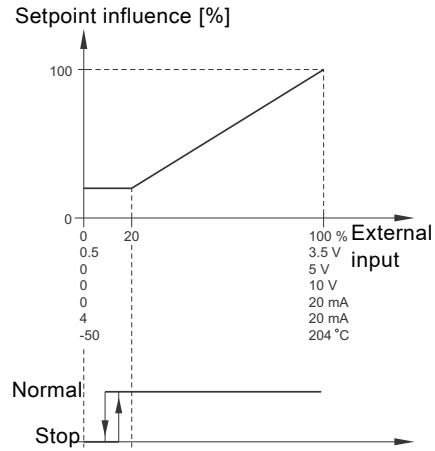

Fig. 49 Linear with Stop

TM06 4167 1615

- Influence table  
The setpoint is influenced by a curve made out of two to eight points. There will be a straight line between the points and a horizontal line before the first point and after the last point.

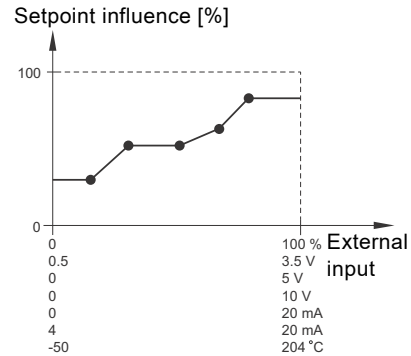

Fig. 50 Influence table, example with five points

TM06 4170 1615



Before the Digital inputs can be enabled, set one of the analog inputs or Pt100/1000 inputs to External setpoint function.

See sections [11.7 Analog inputs](#) and [11.9 Pt100/1000 inputs](#).

### 11.16.2 "Predefined setpoints"

Pump variant	"Predefined setpoints"
NBE, NBSE, NKE, TPE, TPED	•
NBE, NBSE, NKE, TPE, TPED Series 2000	•

You can set and activate seven predefined setpoints by combining the input signals to digital inputs 2, 3 and 4. See the table below.

Set the digital inputs 2, 3 and 4 to "Predefined setpoints" if all seven predefined setpoints are to be used. You can also set one or two of the digital inputs to "Predefined setpoints" but this limits the number of predefined setpoints available.

Digital inputs			Setpoint
2	3	4	
0	0	0	Normal setpoint or stop
1	0	0	Predefined setpoint 1
0	1	0	Predefined setpoint 2
1	1	0	Predefined setpoint 3
0	0	1	Predefined setpoint 4
1	0	1	Predefined setpoint 5
0	1	1	Predefined setpoint 6
1	1	1	Predefined setpoint 7

0: Open contact

1: Closed contact

#### Example

Figure 51 shows how you can use the digital inputs to set seven predefined setpoints. Digital input 2 is open and digital inputs 3 and 4 are closed. If you compare with the table above, you can see that "Predefined setpoint 6" is activated.

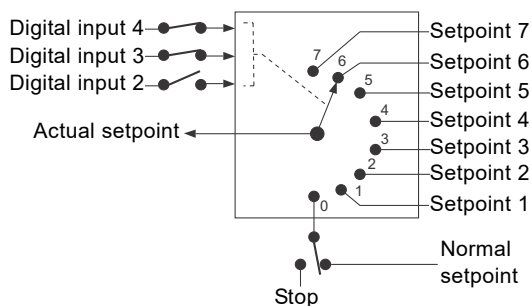

**Fig. 51** Principle sketch showing how predefined setpoints function

If all digital inputs are open, the pump either stops or runs at the normal setpoint. Set the desired action with Grundfos GO or with the advanced control panel.

#### Factory setting

See section 28. [Factory settings](#).

### 11.17 Limit-exceeded function

Pump variant	Limit-exceeded function
NBE, NBSE, NKE, TPE, TPED	•
NBE, NBSE, NKE, TPE, TPED Series 2000	•

This function can monitor a measured parameter or one of the internal values such as speed, motor load or motor current. If a set limit is reached, a selected action can take place. You can set two limit-exceeded functions meaning that you can monitor two parameters or two limits of the same parameter simultaneously. The function requires setting of the following:

#### Measured

Here you set the measured parameter to be monitored.

#### "Limit"

Here you set the limit which activates the function.

#### "Hysteresis band"

Here you set the hysteresis band.

#### "Limit exceeded when"

Here you can set the function to be activated when the selected parameter exceeds or drops below the set limit.

- "Above limit"  
The function is activated if the measured parameter exceeds the set limit.
- "Below limit"  
The function is activated if the measured parameter drops below the set limit.

#### Action

If the value exceeds a limit, you can define an action. You can select the following actions:

- "No action"  
The pump remains in its current state. Use this setting if you only want to have a relay output when the limit is reached. See section 11.12 ["Signal relays 1 and 2" \(Relay outputs\)](#).
- "Warning/alarm"  
There is a warning.
- Stop  
The pump stops.
- Min.  
The pump reduces speed to minimum.
- Max.  
The pump increases speed to maximum.
- "User-defined speed"  
The pumps runs at a speed set by the user.

TMO6 4269 1815

**"Detection delay"**

You can set a detection delay which ensures that the monitored parameter stays above or below a set limit in a set time before the function is activated.

**"Resetting delay"**

The resetting delay is the time from which the measured parameter differs from the set limit including the set hysteresis band and until the function is reset.

**Example**

The function is to monitor the outlet pressure of a pump. If the pressure is below 5 bar for more than 5 seconds, a warning must be given. If the outlet pressure is above 7 bar for more than 8 seconds, you must reset the warning.

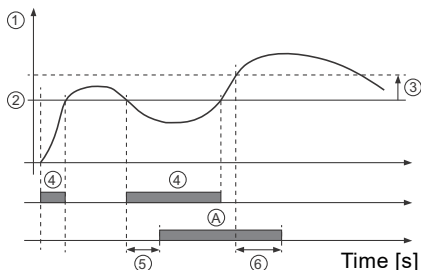

TM06 4603 2515

Fig. 52 "Limit exceeded" (example)

Pos.	Setting parameter	Setting
1	Measured	"Outlet pressure"
2	"Limit"	5 bar
3	"Hysteresis band"	2 bar
4	"Limit exceeded when"	"Below limit"
5	"Detection delay"	5 seconds
6	"Resetting delay"	8 seconds
A	Limit-exceeded function active	-
-	"Action"	"Warning"

**Factory setting**

See section 28. [Factory settings](#).

**11.18 "Pulse flowmeter setup"**

Pump variant	"Pulse flowmeter setup"
NBE, NBSE, NKE, TPE, TPED	•
NBE, NBSE, NKE, TPE, TPED Series 2000	•

You can connect an external pulse flowmeter to one of the digital inputs in order to register the actual and accumulated flows. Based on this, you can also calculate the specific energy.

To enable a pulse flowmeter, set one of the digital-input functions to Accumulated flow and set the pumped volume per pulse. See section 11.10 [Digital inputs](#).

**Factory setting**

See section 28. [Factory settings](#).

**11.19 "Ramps"**

Pump variant	"Ramps"
NBE, NBSE, NKE, TPE, TPED	•
NBE, NBSE, NKE, TPE, TPED Series 2000	•

The ramps determine how quickly the motor can accelerate and decelerate, respectively, during start-stop or setpoint changes.

You can set the following:

- acceleration time, 0.1 to 300 seconds
- deceleration time, 0.1 to 300 seconds.

The times apply to the acceleration from 0 rpm to fixed maximum speed and the deceleration from fixed maximum speed to 0 rpm.

At short deceleration times, the deceleration of the motor may depend on load and inertia as there is no possibility of actively braking the motor.

If the power supply is switched off, the deceleration of the motor only depends on load and inertia.

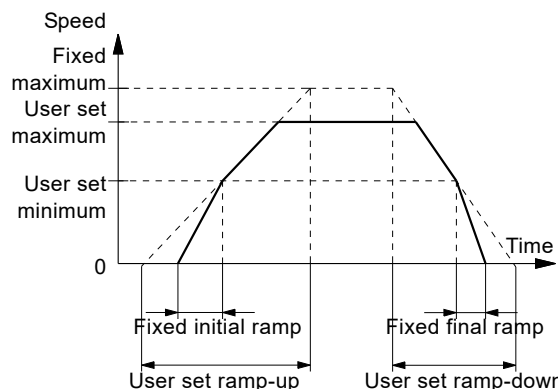

TM03 9439 0908

Fig. 53 Ramp-up and ramp-down

**Factory setting**

See section 28. [Factory settings](#).

**11.20 "Standstill heating"**

Pump variant	"Standstill heating"
NBE, NBSE, NKE, TPE, TPED	•
NBE, NBSE, NKE, TPE, TPED Series 2000	•

You can use this function to avoid condensation in humid environments. When you set the function to "Active" and the pump is in operating mode Stop, a low AC voltage is applied to the motor windings. The voltage is not high enough to make the motor rotate but ensures that sufficient heat is generated to avoid condensation in the motor including the electronic parts in the drive.



Remember to remove the drain plugs and fit a cover over the motor.

## 11.21 Motor bearing monitoring

Pump variant	Motor bearing monitoring
NBE, NBSE, NKE, TPE, TPED	•
NBE, NBSE, NKE, TPE, TPED Series 2000	•

You can set the motor bearing monitoring function to these values:

- "Active"
- Not active

When the function is set to "Active", a counter in the controller starts counting the mileage of the bearings.

The counter continues counting even if the function is changed to Not active, but a warning is not given when it is time for replacement.

When the function is changed to "Active" again, the accumulated mileage is again used to calculate the replacement time.

### Factory setting

See section [28. Factory settings](#).

## 11.22 "Service"

Pump variant	"Service"
NBE, NBSE, NKE, TPE, TPED	•
NBE, NBSE, NKE, TPE, TPED Series 2000	•

### "Time until next service" (Motor bearing service)

This display shows when to replace the motor bearings. The controller monitors the operating pattern of the motor and calculates the period between bearing replacements.

Displayable values:

- "in 2 years"
- "in 1 year"
- "in 6 months"
- "in 3 months"
- "in 1 month"
- "in 1 week"
- "Now"

### "Bearing replacements"

Indicates the number of bearing replacements that have been done during the lifetime of the motor.

### Bearings replaced (Motor bearing maintenance)

When the bearing monitoring function is active, the controller gives a warning when the motor bearings are to be replaced.

When you have replaced the motor bearings, confirm this action by pressing [Bearings replaced].

## 11.23 "Number" (Pump number)

Pump variant	"Number"
NBE, NBSE, NKE, TPE, TPED	•
NBE, NBSE, NKE, TPE, TPED Series 2000	•

You can allocate a unique number to the pump. This makes it possible to distinguish between pumps in connection with bus communication.

### Factory setting

See section [28. Factory settings](#).

## 11.24 "Radio communication" (Enable/disable radio comm.)

Pump variant	"Radio communication"
NBE, NBSE, NKE, TPE, TPED	•
NBE, NBSE, NKE, TPE, TPED Series 2000	•

You can set the radio communication to either enabled or disabled. You can use this function in areas where radio communication is not allowed.

IR communication remains active.

### Factory setting

See section [28. Factory settings](#).

## 11.25 Language

Pump variant	Language
NBE, NBSE, NKE, TPE, TPED	•
NBE, NBSE, NKE, TPE, TPED Series 2000	•

This menu is only available in the advanced control panel.

In this menu you can select the desired language. A number of languages is available.

## 11.26 "Date and time" (Set date and time)

Pump variant	"Date and time"
NBE, NBSE, NKE, TPE, TPED	•
NBE, NBSE, NKE, TPE, TPED Series 2000	•

You can set date and time as well as how they are to be shown in the display:

- Select date format:  
YYYY-MM-DD  
DD-MM-YYYY  
MM-DD-YYYY.
- Select time format:  
HH:MM 24-hour clock  
HH:MM am/pm 12-hour clock.
- Set date
- Set time.

### Factory setting

See section [28. Factory settings](#).

## 11.27 "Unit configuration" (Units)

Pump variant	"Unit configuration"
NBE, NBSE, NKE, TPE, TPED	•
NBE, NBSE, NKE, TPE, TPED Series 2000	•

In this menu you can select between SI and US units. The setting can be made generally for all parameters or customised for each parameter.

### Factory setting

See section [28. Factory settings](#).

### 11.28 "Buttons on product" (Enable/disable settings)

Pump variant	"Buttons on product"
NBE, NBSE, NKE, TPE, TPED	•
NBE, NBSE, NKE, TPE, TPED Series 2000	•

In this display, you can disable the possibility of making settings.



#### Grundfos GO

If you set the buttons to "Not active", the buttons on the standard control panel are disabled. If you set the buttons to "Not active" on pumps with an advanced control panel, see below.

#### Advanced control panel

If you have disabled the settings, you can still use the buttons to navigate through the menus but you cannot make changes in the Settings menu.

When you have disabled the possibility to make settings, the  symbol appears in the display.

To unlock the pump and allow settings, press  and  simultaneously for at least 5 seconds.

Standard control panel

The  button always remains active but you can only unlock all other buttons on the pump with Grundfos GO.

#### Factory setting

See section [28. Factory settings](#).

### 11.29 Delete history

Pump variant	Delete history
NBE, NBSE, NKE, TPE, TPED	•
NBE, NBSE, NKE, TPE, TPED Series 2000	•

In this menu, you can delete the following historic data:

- "Delete operating log".
- "Delete heat energy data".
- "Delete energy consumption".

### 11.30 Define Home display

Pump variant	Define Home display
NBE, NBSE, NKE, TPE, TPED	•
NBE, NBSE, NKE, TPE, TPED Series 2000	•

This menu is only available in the advanced control panel.

In this menu, you can set the Home display to show up to four user-set parameters.

### 11.31 Display settings

Pump variant	Display settings
NBE, NBSE, NKE, TPE, TPED	•
NBE, NBSE, NKE, TPE, TPED Series 2000	•

This menu is only available in the advanced control panel.

In this menu you can adjust the display brightness and set whether or not the display is to turn off if no buttons have been activated for a period of time.

### 11.32 "Store settings" (Store actual settings)

Pump variant	"Store settings"
NBE, NBSE, NKE, TPE, TPED	•
NBE, NBSE, NKE, TPE, TPED Series 2000	•

#### Grundfos GO

In this menu, you can store the actual settings for later use in the same pump or in other pumps of the same type.

#### Advanced control panel

In this menu, you can store the actual settings for later use in the same pump.

### 11.33 "Recall settings" (Recall stored settings)

Pump variant	"Recall settings"
NBE, NBSE, NKE, TPE, TPED	•
NBE, NBSE, NKE, TPE, TPED Series 2000	•

#### Grundfos GO

In this menu, you can recall stored settings from a number of previously stored settings that the pump then uses.

#### Advanced control panel

In this menu, you can recall the last stored settings that the pump then uses.

### 11.34 "Undo"

Pump variant	"Undo"
NBE, NBSE, NKE, TPE, TPED	•
NBE, NBSE, NKE, TPE, TPED Series 2000	•

This menu is only available in Grundfos GO.

In this display, you can undo all settings that have been made with Grundfos GO in the current communication session. You cannot undo a Recall stored settings action.

### 11.35 "Pump name"

Pump variant	"Pump name"
NBE, NBSE, NKE, TPE, TPED	•
NBE, NBSE, NKE, TPE, TPED Series 2000	•

This menu is only available in Grundfos GO.

In this display, you can give the pump a name. In this way, you can easily identify the pump when connecting with Grundfos GO.

#### Factory setting

See section [28. Factory settings](#).

### 11.36 "Connection code"

Pump variant	"Connection code"
NBE, NBSE, NKE, TPE, TPED	•
NBE, NBSE, NKE, TPE, TPED Series 2000	•

This menu is only available in Grundfos GO.

You can set a connection code to avoid having to press the connection button each time and to restrict remote access to the product.

#### Setting the code in the product using Grundfos GO

1. Connect Grundfos GO to the product.
2. In the product dashboard, select "Settings".
3. Choose "Connection code".
4. Enter the wanted code and press [OK].  
The code must be a character string, ASCII. You can always modify the code. The old code is not needed.

#### Setting the code in Grundfos GO

You can set a default connection code in Grundfos GO so that it automatically attempts to connect to the selected product via this code.

When you select a product with the same connection code in Grundfos GO, Grundfos GO automatically connects to the product and you do not have to press the connection button on the module.

Set the default code in Grundfos GO in this way:

1. In the main menu, under "General", select "Settings".
2. Choose "Remote".
3. Enter the connection code in the field "Preset connection code". The field now says "Connection code set".

You can always modify the default connection code by pressing [Delete] and entering a new one.

If Grundfos GO fails to connect and ask you to press the connection button on the product, it means that the product has no connection code or has a different connection code. In this case, you can only establish connection via the connection button.

After setting a connection code, you must switch off the product until the light in Grundfos Eye turns off before you can use the new connection code.

#### Factory setting

See section [28. Factory settings](#).

### 11.37 Run start-up guide

Pump variant	Run start-up guide
NBE, NBSE, NKE, TPE, TPED	•
NBE, NBSE, NKE, TPE, TPED Series 2000	•

This menu is only available in the advanced control panel.

The startup guide automatically starts when you start the pump for the first time.

You can always run the startup guide later via this menu.

The startup guide guides you through the general settings of the pump.

- Language. See section [11.25 Language](#).
- Select date format.  
See section [11.26 "Date and time" \(Set date and time\)](#).
- Set date.  
See section [11.26 "Date and time" \(Set date and time\)](#).
- Select time format.  
See section [11.26 "Date and time" \(Set date and time\)](#).
- Set time.  
See section [11.26 "Date and time" \(Set date and time\)](#).
- Setting of pump
  - Go to Home
  - Run with Constant curve/Run with Constant pressure.  
See section [11.5 "Control mode"](#)
  - Go to "Assisted pump setup".  
See section [11.41 Assisted pump setup](#).
  - Return to factory settings.

\* Applies only for pumps with advanced functional module, FM 300. For further information, see section [18. Identification of functional module](#).

### 11.38 Alarm log

Pump variant	Alarm log
NBE, NBSE, NKE, TPE, TPED	•
NBE, NBSE, NKE, TPE, TPED Series 2000	•

This menu contains a list of logged alarms from the product. The log shows the name of the alarm, when the alarm occurred and when it was reset.

### 11.39 Warning log

Pump variant	Warning log
NBE, NBSE, NKE, TPE, TPED	•
NBE, NBSE, NKE, TPE, TPED Series 2000	•

This menu contains a list of logged warnings from the product. The log shows the name of the warning, when the warning occurred and when it was reset.

### 11.40 Assist

Pump variant	Assist
NBE, NBSE, NKE, TPE, TPED	•
NBE, NBSE, NKE, TPE, TPED Series 2000	•

The menu consist of functions which take you through the steps needed to set the pump.

### 11.41 Assisted pump setup

Pump variant	Assisted pump setup
NBE, NBSE, NKE, TPE, TPED	•
NBE, NBSE, NKE, TPE, TPED Series 2000	•

The menu guides you through the following:

#### Setting of pump

- Selection of control mode. See page 24.
- Configuration of feedback sensors.
- Adjusting the setpoint. See page 24.
- Controller settings. See page 34.
- Summary of settings.

#### Example of how to use the Assisted pump setup for setting up the pump to constant pressure:

##### Grundfos GO

1. Open the Assist menu.
2. Select Assisted pump setup.
3. Select the control mode "Constant pressure".
4. Read the description of this control mode.
5. Select which analog input to use as sensor input.
6. Select sensor function according to where the sensor is installed in the system. See fig. 40.
7. Select electrical input signal according to the sensor specifications.
8. Select measuring unit according to the sensor specifications.
9. Set the minimum and maximum sensor values according to the sensor specifications.
10. Set the desired setpoint.
11. Set the controller settings  $K_p$  and  $T_i$ . See the recommendations in section 11.14 "Controller" ("Controller settings").
12. Type the pump name.
13. Check the summary of settings and confirm them.

##### Advanced control panel

1. Open the Assist menu.
2. Select Assisted pump setup.
3. Select the control mode Const. pressure.
4. Select which analog input to be used as sensor input.
5. Select the measured parameter to be controlled. See fig. 40.
6. Select measuring unit according to the sensor specifications.
7. Set the minimum and maximum sensor values according to the sensor specifications.
8. Select electrical input signal according to the sensor specifications.
9. Set the setpoint.
10. Set the controller settings  $K_p$  and  $T_i$ . See recommendations in section 11.14 "Controller" ("Controller settings").
11. Check the summary of settings and confirm them by pressing [OK].

### 11.42 Setup, analog input

Pump variant	Setup, analog input
NBE, NBSE, NKE, TPE, TPED	•
NBE, NBSE, NKE, TPE, TPED Series 2000	•

This menu is only available in the advanced control panel.

The menu guides you through the following:

#### Setup, analog input

- Analog inputs 1 to 3. See page 29.
- Pt100/1000 input 1 and 2. See page 30.
- Adjusting the setpoint. See page 24.
- Summary.

### 11.43 "Multipump setup" (Setup of multi-pump system)

Pump variant	"Multipump setup"
NBE, NBSE, NKE, TPE, TPED	•
NBE, NBSE, NKE, TPE, TPED Series 2000	•

The multipump function enables the control of two pumps connected in parallel without the use of external controllers. The pumps in a multipump system communicate with each other via the wireless GENIair connection or the wired GENI connection.

A multipump system is set via a selected pump, i.e. the master pump, which is the first selected pump.

If two pumps in the system are configured with an outlet-pressure sensor, both pumps can function as master pumps and take over the master pump function if the other fails. This provides additional redundancy in the multipump system.

The multipump functions are described in the following sections.

#### 11.43.1 Alternating operation

Alternating operation functions as a duty/standby operating mode and is possible with two pumps of same size and type connected in parallel. The main purpose of the function is to ensure an even amount of running hours and to ensure that the standby pump takes over if the running pump stops due to an alarm.

Each pump requires a non-return valve in series with the pump.

You can choose between two alternating operation modes:

- "Alternating operation, time"  
Pump changeover to the other is based on time.
- "Alternating operation, energy"  
Pump changeover to the other is based on energy consumption.

If the duty pump fails, the other pump takes over automatically.

### 11.43.2 Backup operation

Backup operation is possible with two pumps of same size and type connected in parallel. Each pump requires a non-return valve in series with the pump.

One pump is operating continuously. The backup pump is operated for a short time each day to prevent seizing up. If the duty pump stops due to a fault, the backup pump starts automatically.

### 11.43.3 Cascade operation

Cascade operation ensures that the pump performance is automatically adapted to the consumption by switching pumps on or off. The system thus runs as energy-efficiently as possible with a constant pressure and a limited number of pumps.

All pumps in operation run at equal speed. Pump changeover is automatic and depends on energy, operating hours and fault.

If the pump system consists of two to four single-head pumps connected in parallel, the pumps must be of the same type and size. Each pump requires a non-return valve in series with the pump.

Set the control mode to "Constant pressure" or "Constant curve". In "Constant curve" all pumps will run at the same time.

This function is available with up to 4 motors installed in parallel. The motors must be of the same size and the pumps must be of the same model.

- The performance is adjusted to the demand through cutting pumps in or out and through parallel control of the pumps in operation.
- The controller maintains a constant pressure through continuous adjustment of the speed of the pumps.
- Pump changeover is automatic and depends on load, operating hours and fault detection.
- All pumps in operation run at the same speed.
- The number of pumps in operation also depends on the energy consumption of the pumps. If only one pump is required, two pumps will run at a lower speed if this results in a lower energy consumption.
- If several motors in the system have a sensor, they can all function as master and take over the master function if the other motors fail.

### 11.43.4 "Sensor to be used"

Define the sensor to be used for controlling the pump system. If a sensor is placed in a way that it is able to measure the sensor output from all pumps in the system, for example, in the manifold, then select "Master pump sensor".

If a sensor is placed on, or across the individual pumps, for example, installed behind non-return valves and not able to measure the sensor output from all pumps, then select "Running pump sensor".

### 11.43.5 Setting a multipump system

You can set a multipump system in the following ways:

- [Grundfos GO and wireless pump connection](#)
- [Grundfos GO and wired pump connection](#)
- [Advanced control panel and wireless pump connection](#)
- [Advanced control panel and wired pump connection](#)

See step-by-step descriptions below.

#### Grundfos GO and wireless pump connection

1. Power on both pumps.
2. Establish contact to one of the pumps with Grundfos GO.
3. Set the needed analog and digital inputs via Grundfos GO according to the connected equipment and the required functionality. See section [11.41 Assisted pump setup](#).
4. Assign a pump name to the pump using Grundfos GO. See section [11.35 "Pump name"](#).
5. Disconnect Grundfos GO from the pump.
6. Establish contact to the other pump.
7. Set the needed analog and digital inputs via Grundfos GO according to the connected equipment and the required functionality. See section [11.41 Assisted pump setup](#).
8. Assign a pump name to the pump using Grundfos GO. See section [11.35 "Pump name"](#).
9. Select the "Assist" menu and "Multipump setup".
10. Select the desired multipump function. See sections [11.43.1 Alternating operation](#), [11.43.2 Backup operation](#) and [11.43.3 Cascade operation](#).
11. Press [>] to continue.
12. Set the time for pump changeover such as the time at which the alternation between the two pumps is to take place. This step applies only if you have selected "Alternating operation, time" and if the pumps are fitted with FM 300.
13. Press [>] to continue.
14. Select "Radio" as the communication method to be used between the two pumps.
15. Press [>] to continue.
16. Press "Select pump 2".
17. Select the pump from the list.  
Use the [OK] or  button to identify the pump.
18. Press [>] to continue.
19. Confirm the multipump setup by pressing [Send].
20. Press [Finish] in the "Setup complete" dialog box.
21. Wait for the green indicator light in the middle of Grundfos Eye to light up.

The multipump system has now been set.

### Grundfos GO and wired pump connection

1. Connect the two pumps with each other with a 3-core screened cable between the GENIbus terminals A, Y, B.
2. Power on both pumps.
3. Establish contact to one of the pumps with Grundfos GO.
4. Set the needed analog and digital inputs via Grundfos GO according to the connected equipment and the required functionality. See section [11.41 Assisted pump setup](#).
5. Assign a pump name to the pump using Grundfos GO. See section [11.35 "Pump name"](#).
6. Assign pump number 1 to the pump. See section [11.23 "Number" \(Pump number\)](#).
7. Disconnect Grundfos GO from the pump.
8. Establish contact to the other pump.
9. Set the needed analog and digital inputs via Grundfos GO according to the connected equipment and the required functionality. See section [11.41 Assisted pump setup](#).
10. Assign a pump name to the pump using Grundfos GO. See section [11.35 "Pump name"](#).
11. Assign pump number 2 to the pump. See section [11.23 "Number" \(Pump number\)](#).
12. Select the "Assist" menu and choose "Multipump setup".
13. Select the desired multipump function. See sections [11.43.1 Alternating operation](#), [11.43.2 Backup operation](#) and [11.43.3 Cascade operation](#).
14. Press [>] to continue.
15. Set the time for pump changeover such as the time at which the alternation between the two pumps is to take place. This step applies only if you have selected "Alternating operation, time" and if the pumps are fitted with FM 300.
16. Press [>] to continue.
17. Select "BUS cable" as the communication method to be used between the two pumps.
18. Press [>] to continue.
19. Press "Select pump 2".
20. Select the additional pump from the list.  
Use the [OK] or  button to identify the additional pump.
21. Press [>] to continue.
22. Press [Send].
23. Press [Finish] in the "Setup complete" dialog box.
24. Wait for the green indicator light in the middle of Grundfos Eye to light up.

The multipump system has now been set.

### Advanced control panel and wireless pump connection

1. Power on both pumps.
2. On both pumps, set the needed analog and digital inputs according to the connected equipment and the required functionality. See section [11.41 Assisted pump setup](#).
3. Select the Assist menu on one of the pumps and choose Setup of multi-pump system.
4. Press [>] to continue.
5. Select "Wireless" as the communication method to be used between the two pumps.
6. Press [>] to continue.
7. Select the desired multipump function. See sections [11.43.1 Alternating operation](#), [11.43.2 Backup operation](#) and [11.43.3 Cascade operation](#).
8. Press [>] three times to continue.
9. Press [OK] to search for other pumps.  
The green indicator light in the middle of Grundfos Eye flashes on the other pumps.
10. Press the connect button on the pump which is to be added to the multipump system.
11. Press [>] to continue.
12. Set the time for pump changeover i.e. the time at which the alternation between the two pumps is to take place. This step applies only if you have selected "Alternating operation, time" and if the pumps are fitted with FM 300.
13. Press [>] to continue.
14. Press [OK].  
The multipump function icons appear in the bottom of the control panels.

The multipump system has now been set.

### Advanced control panel and wired pump connection

1. Connect the two pumps with each other with a 3-core screened cable between the GENIbus terminals A, Y, B.
2. Set the needed analog and digital inputs according to the connected equipment and the required functionality. See section [11.41 Assisted pump setup](#).
3. Assign pump number 1 to the first pump. See section [11.23 "Number" \(Pump number\)](#).
4. Assign pump number 2 to the other pump. See section [11.23 "Number" \(Pump number\)](#).
5. Select the Assist menu on one of the pumps and choose Setup of multi-pump system.
6. Press [>] to continue.
7. Select "Wired GENIbus" as the communication method to be used between the two pumps.
8. Press [>] twice to continue.
9. Select the desired multipump function. See sections [11.43.1 Alternating operation](#), [11.43.2 Backup operation](#) and [11.43.3 Cascade operation](#).
10. Press [>] to continue.
11. Press [OK] to search for other pumps.
12. Select the additional pump from the list.
13. Press [>] to continue.
14. Set the time for pump changeover i.e. the time at which the alternation between the two pumps is to take place.  
This step applies only if you have selected "Alternating operation, time" and if the pumps are fitted with FM 300.
15. Press [>] to continue.
16. Press [OK].  
The multipump function icons appear in the bottom of the control panels.

The multipump system has now been set.

### Disabling the multipump function via Grundfos GO

1. Select the "Assist" menu.
2. Select "Multipump setup".
3. Select "Disable".
4. Press [>] to continue.
5. Confirm the multipump setup by pressing [Send].
6. Press [Finish].

The multipump function has now been disabled.

### Disabling a multipump via advanced control panel

1. Select the Assist menu.
2. Select Setup of multi-pump system.
3. Press [>] to continue.
4. Confirm No multi-pump function by pressing [OK].
5. Press [>] to continue.
6. Press [OK].

The multipump system has now been disabled.

### 11.44 Description of control mode

Pump variant	Description of control mode
NBE, NBSE, NKE, TPE, TPED	•
NBE, NBSE, NKE, TPE, TPED Series 2000	•

This menu is only available in the advanced control panel.

This menu describes each of the possible control modes. See also section [11.5 "Control mode"](#).

### 11.45 Assisted fault advice

Pump variant	Assisted fault advice
NBE, NBSE, NKE, TPE, TPED	•
NBE, NBSE, NKE, TPE, TPED Series 2000	•

This menu gives guidance and corrective actions in case of pump failures.

## 12. Selection of control mode

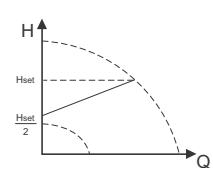
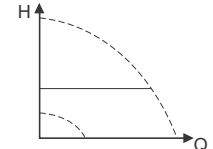
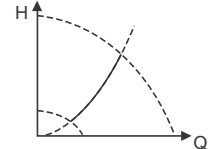
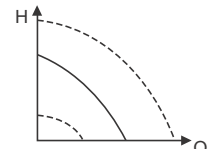
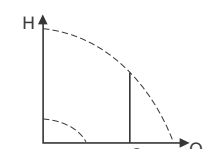
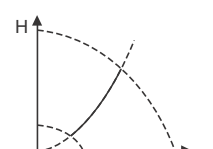
System application	Select this control mode
<p>In systems with relatively large pressure losses in the distribution pipes and in air-conditioning and cooling systems.</p> <ul style="list-style-type: none"> <li>Two-pipe heating systems with thermostatic valves and the following:               <ul style="list-style-type: none"> <li>very long distribution pipes</li> <li>strongly throttled balancing valves</li> <li>differential-pressure regulators</li> <li>large pressure losses in those parts of the system through which the total quantity of water flows, for example boiler, heat exchanger and distribution pipe up to the first branching.</li> </ul> </li> <li>Primary circuit pumps in systems with large pressure losses in the primary circuit.</li> <li>Air-conditioning systems with the following:               <ul style="list-style-type: none"> <li>heat exchangers, fan coils</li> <li>cooling ceilings</li> <li>cooling surfaces.</li> </ul> </li> </ul>	<p>Proportional pressure</p> 
<p>In systems with relatively small pressure losses in the distribution pipes.</p> <ul style="list-style-type: none"> <li>Two-pipe heating systems with thermostatic valves and the following:               <ul style="list-style-type: none"> <li>sized for natural circulation</li> <li>small pressure losses in those parts of the system through which the total quantity of water flows, for example boiler, heat exchanger and distribution pipe up to the first branching, or modified to a high differential temperature between flow pipe and return pipe, for example district heating.</li> </ul> </li> <li>Underfloor heating systems with thermostatic valves.</li> <li>One-pipe heating systems with thermostatic valves or pipe balancing valves.</li> <li>Primary circuit pumps in systems with small pressure losses in the primary circuit.</li> </ul>	<p>Constant differential pressure</p> 
<p>In systems with a fixed system characteristic.</p> <p>Examples:</p> <ul style="list-style-type: none"> <li>one-pipe heating systems</li> <li>boiler shunts</li> <li>systems with three-way valves</li> <li>domestic hot-water circulation.</li> </ul>	<p>Constant temperature and constant differential temperature</p> 
<p>If an external controller is installed, the pump is able to change from one constant curve to another, depending on the value of the external signal.</p> <p>You can also set the pump to operate according to the maximum or minimum curve, like an uncontrolled pump:</p> <ul style="list-style-type: none"> <li>Use the maximum-curve mode in periods in which a maximum flow is required. This operating mode is for instance suitable for systems with hot-water priority.</li> <li>Use the minimum-curve mode in periods in which a minimum flow is required.</li> </ul>	<p>Constant curve</p> 
<p>In systems requiring a constant flow, independently of pressure drop.</p> <p>Examples:</p> <ul style="list-style-type: none"> <li>chillers for air-conditioning</li> <li>heating surfaces</li> <li>cooling surfaces.</li> </ul>	<p>Constant flow rate</p> 
<p>In systems requiring a constant tank level, independently of the flow rate.</p> <p>Examples:</p> <ul style="list-style-type: none"> <li>process-water tanks</li> <li>boiler-condensate tanks.</li> </ul>	<p>Constant level</p> 

System application	Select this control mode
<p>In systems with pumps operating in parallel.</p> <p>The multipump function enables the control of two to four single-head pumps connected in parallel and twin-head pumps without the use of external controllers. The pumps in a multipump system communicate with each other via the wireless GENIair connection or the wired GENI connection.</p>	<p>Assist menu Setup of multi-pump system</p>

### 13. Bus signal

The pump supports serial communication via an RS-485 input. The communication is carried out according to the Grundfos GENIbus protocol and enables connection to other pumps as well as a building management system or another external control system.

Via a bus signal, you can remote-set pump operating parameters, such as setpoint and operating mode. At the same time, the pump can, via the bus, provide status information about important parameters, such as actual value of control parameter, input power and fault indications.

Contact Grundfos for further information.



If you use a bus signal, the number of settings available via Grundfos GO are reduced.

## 14. Priority of settings

You can always set the pump to stop by pressing ☹ on the pump control panel. When the pump is not in Stop mode, you can always set the pump to stop by continuously pressing ☹. Furthermore, you can set the pump to maximum speed by continuously pressing ☺. You can always set the pump to operation at maximum speed or to stop with Grundfos GO.

If two or more functions are enabled at the same time, the pump operates according to the function with the highest priority.

### Example

If you have set the pump to maximum speed via the digital input, the pump control panel or Grundfos GO can only set the pump to Manual or Stop.

The priority of the settings appears from the table below.

Priority	Start-stop button	Grundfos GO or control panel on pump	Digital input	Bus communication
1	Stop			
2		Stop*		
3		Manual		
4		"Max. speed"*/ "User-defined speed"		
5			Stop	
6			"User-defined speed"	
7				Stop
8				"Max. speed"
9				"Min. speed"
10				"Start"
11			"Max. speed"	
12		"Min. speed"		
13			"Min. speed"	
14			"Start"	
15		"Start"		

\* "Stop" and "Max. speed" settings made with Grundfos GO or on the motor control panel can be overruled by another operating-mode command sent from a bus, for example "Start". If the bus communication is interrupted, the motor resumes its previous operating mode, for example "Stop", selected with Grundfos GO or on the motor control panel.

## 15. Grundfos Eye

The operating condition of the pump is indicated by the Grundfos Eye on the control panel. See fig. 54, A.

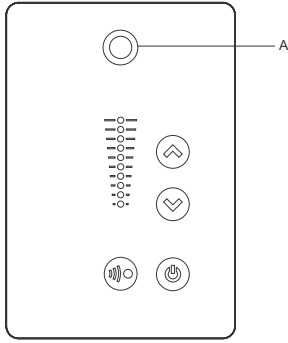

TM05 5993 4312

Fig. 54 Grundfos Eye





























































Grundfos Eye	Indication	Description
	No lights are on.	The power is off. The pump is not running.
	The two opposite green indicator lights are rotating in the direction of rotation of the pump when seen from the non-drive end.	The power is on. The pump is running.
	The two opposite green indicator lights are permanently on.	The power is on. The pump is not running.
	One yellow indicator light is rotating in the direction of rotation of the pump when seen from the non-drive end.	Warning. The pump is running.
	One yellow indicator light is permanently on.	Warning. The pump has stopped.
	The two opposite red indicator lights flash simultaneously.	Alarm. The pump has stopped.
	The green indicator light in the middle flashes quickly four times.	This is a feedback signal which the pump gives in order to ensure identification of itself.
	The green indicator light in the middle flashes continuously.	Grundfos GO or another pump is trying to communicate with the pump. Press  on the pump control panel to allow communication.
	The green indicator light in the middle is permanently on.	Remote control with Grundfos GO via radio. The pump is communicating with Grundfos GO via radio connection.
	The green indicator light in the middle flashes quickly while Grundfos Go is exchanging data with the pump. It takes a few seconds.	Remote control with Grundfos GO via infrared light. The pump is receiving data from Grundfos GO via infrared communication.

## 16. Signal relays

The pump has two outputs for potential-free signals via two internal relays.

You can set the signal outputs to Operation, Pump running, Ready, Alarm and Warning.

The functions of the two signal relays appear from the table below.

Description	Grundfos Eye	Contact position of signal relays when activated					Operating mode
		Operation	Running	Ready	Alarm	Warning	
The power is off.	 Off						-
The pump runs in "Normal" mode.	 Green, rotating						"Normal", "Min." or "Max."
The pump runs in "Manual" mode.	 Green, rotating						"Manual"
The pump is in operating mode "Stop".	 Green, steady						"Stop"
Warning, but the pump is running.	 Yellow, rotating						"Normal", "Min." or "Max."
Warning, but the pump runs in "Manual" mode.	 Yellow, rotating						"Manual"
Warning, but the pump was stopped via a "Stop" command.	 Yellow, steady						"Stop"
Alarm, but the pump is running.	 Red, rotating						"Normal", "Min." or "Max."
Alarm, but the pump runs in "Manual" mode.	 Red, rotating						"Manual"
The pump has stopped due to an alarm.	 Red, flashing						"Stop"

## 17. Installing a communication interface module

### DANGER

#### Electric shock



Death or serious personal injury  
 - Switch off the power supply to the motor and to the signal relays. Wait at least 5 minutes before starting any work on the motor. Make sure that the power supply cannot be accidentally switched on.



Always use an antistatic service kit when handling electronic components. This prevents static electricity from damaging the components. When unprotected, place the component on the antistatic cloth.

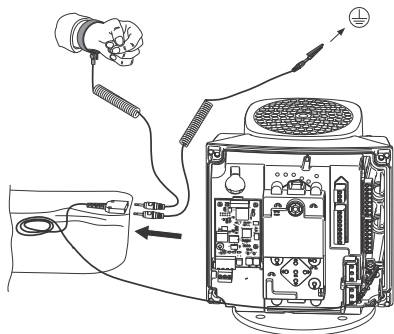

Fig. 55 Antistatic service kit

1. Loosen the four screws (fig. 56, A) and remove the terminal box cover (fig. 56, B).

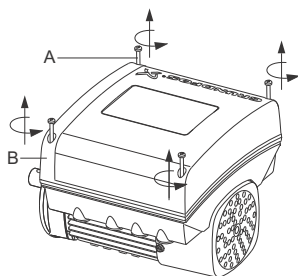

Fig. 56 Removing the terminal box cover

2. Remove the CIM cover (fig. 57, A) by pressing the locking tab (fig. 57, B) and lifting the end of the cover (fig. 57, C). Then lift the cover off the hooks (fig. 57, D).

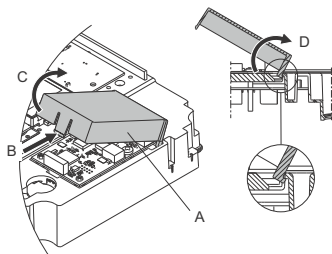

Fig. 57 Removing the CIM cover

3. Remove the securing screw (fig. 58, A).

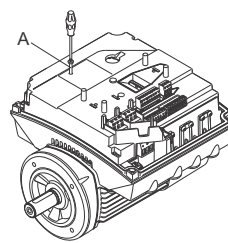

Fig. 58 Removing the securing screw

4. Fit the CIM module by aligning it with the three plastic holders (fig. 59, A) and the connecting plug (fig. 59, B). Press home the module using your fingers.

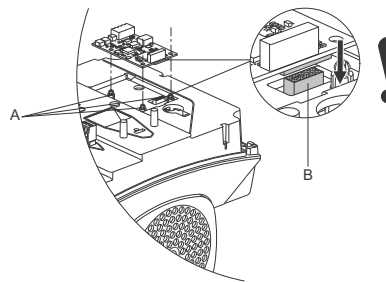

Fig. 59 Fitting the CIM module

5. Fit and tighten the securing screw (fig. 58, A) to 1.3 Nm.
6. Make the electrical connections to the CIM module as described in the instructions delivered with the module.
7. Connect the cable screens of the bus cables to ground (earth) via one of the ground (earth) clamps (fig. 60, A).

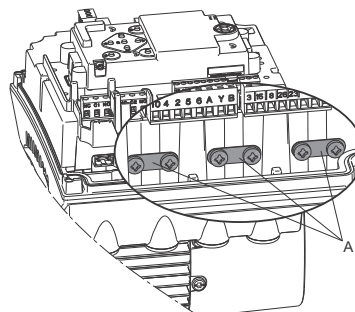

Fig. 60 Connecting the cable screens to ground (earth)

TM06 4082 1515

TM06 4462 2315

TM06 4083 1515

TM06 4081 1515

TM06 4195 1615

TM06 4084 1515

- Route the wires for the CIM module. See the example in fig. 61.

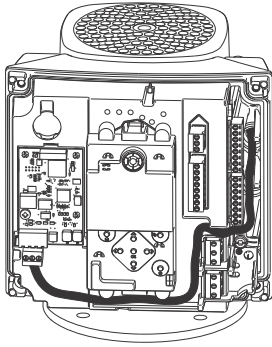

TM06 4085 1515

**Fig. 61** Example of wire routing

- Fit the CIM cover.
- If the CIM module is supplied with an FCC label, then place this on the terminal box. See fig. 62.

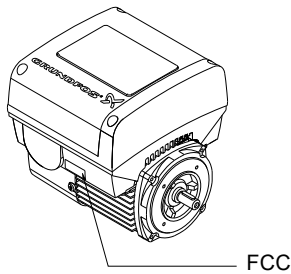

TM05 7028 0413

**Fig. 62** FCC label

- Fit the terminal box cover (fig. 56, B) and cross-tighten the four mounting screws (fig. 56, A) to 6 Nm.



Make sure that the terminal box cover is aligned with the control panel. See section 20. *Changing the position of the control panel.*

## 18. Identification of functional module

You can identify the fitted module in one of the following ways:

### Grundfos GO

You can identify the functional module in the "Fitted modules" menu under "Status".

### Pump display

For pumps fitted with the advanced control panel, you can identify the functional module in the Fitted modules menu under Status.

### Motor nameplate

You can identify the fitted module on the motor nameplate. See fig. 63.

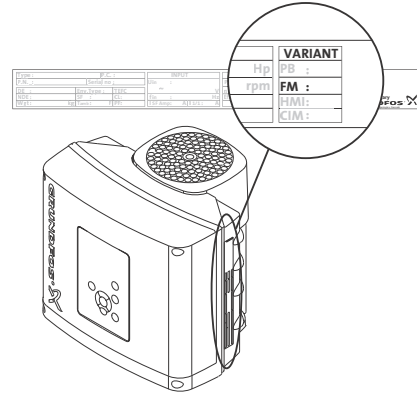

TM06 1889 3314

**Fig. 63** Identification of functional module

Variant	Description
FM 200	Standard functional module
FM 300	Advanced functional module

## 19. Identification of control panel

You can identify the fitted module in one of the following ways:

### Grundfos GO

You can identify the control panel in the "Fitted modules" menu under "Status".

### Pump display

For pumps fitted with the advanced control panel, you can identify the control panel in the Fitted modules menu under Status.

### Motor nameplate

You can identify the fitted control panel on the motor nameplate. See fig. 64.

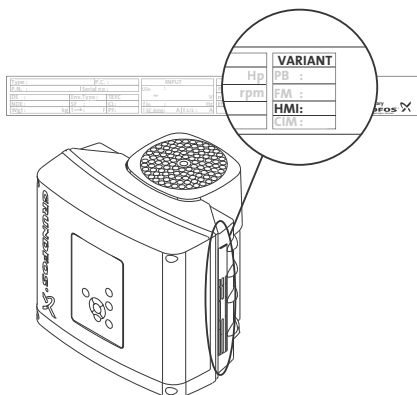

Fig. 64 Identification of control panel

Variant	Description
HMI 200	Standard control panel
HMI 300	Advanced control panel

TM06 4013 1415

## 20. Changing the position of the control panel

### DANGER

#### Electric shock



Death or serious personal injury

- Switch off the power supply to the motor and to the signal relays. Wait at least 5 minutes before starting any work on the motor. Make sure that the power supply cannot be accidentally switched on.

You can turn the control panel 180°. Follow the instructions below.

1. Loosen the four screws, TX25, of the terminal box cover.

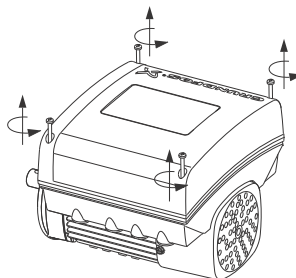

Fig. 65 Loosening the screws

2. Remove the terminal box cover.

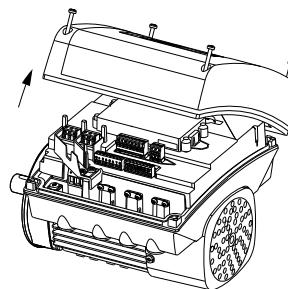

Fig. 66 Removing the terminal box cover

3. Press and hold in the two locking tabs, A, while gently lifting the plastic cover, B.

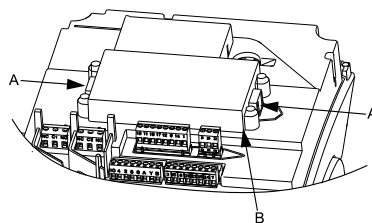

Fig. 67 Lifting the plastic cover

TM05 5351 3612

TM05 5352 3612

TM05 5353 3612

- Turn the plastic cover 180 °.



Do not twist the cable more than 90 °.

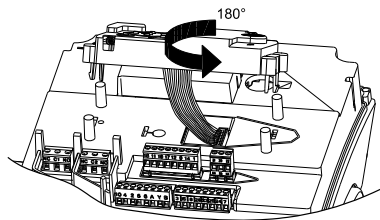

Fig. 68 Turning the plastic cover

- Position the plastic cover correctly on the four rubber pins, C. Make sure that the locking tabs, A are placed correctly.

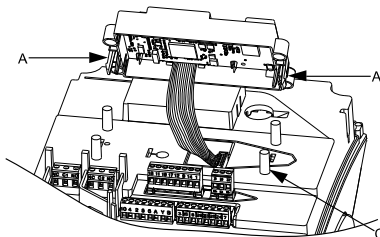

Fig. 69 Positioning the plastic cover

- Fit the terminal box cover, and make sure that it is also turned 180 ° so that the buttons on the control panel are aligned with the buttons on the plastic cover.
- Tighten the four screws, TX25, with 5 Nm.

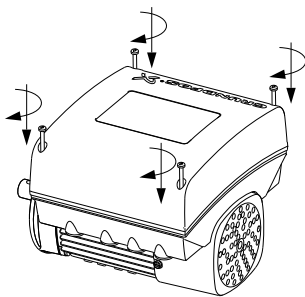

Fig. 70 Fitting the terminal box cover

TM05 5354 3612

TM05 5355 3612

TM05 5356 3612

## 21. Servicing the product

### DANGER

#### Electric shock



Death or serious personal injury  
 - Switch off the power supply to the motor and to the signal relays. Wait at least 5 minutes before starting any work on the motor. Make sure that the power supply cannot be accidentally switched on.

### DANGER

#### Magnetic field



Death or serious personal injury  
 - Do not handle the motor or rotor if you have a pacemaker.

### 21.1 Motor

If service is needed on the product, please contact Grundfos Service.

### 21.2 Pump

Service documentation is available in Grundfos Product Center (<http://product-selection.grundfos.com/>).

If you have any questions, please contact the nearest Grundfos company or service workshop.

## 22. Cleaning the product

### WARNING

#### Electric shock



Death or serious personal injury  
 - Switch off the power supply to the motor and to the signal relays. Check that the terminal box cover is intact before spraying water on the product.

In order to avoid condensation in the motor, let the motor cool down before spraying it with cold water.

## 23. Megging



Megging of an installation incorporating MGE motors is not allowed, as the built-in electronics may be damaged.

## 24. Technical data, single-phase motors

### 24.1 Supply voltage

- 1 x 200-230 V - 10 %/+ 10 %, 50/60 Hz, PE.

Check that the supply voltage and frequency correspond to the values stated on the nameplate.

#### Recommended fuse size

Motor size [HP]	Motor size [kW]	Min. [A]	Max. [A]
0.16 - 1.00	0.12 - 0.75	6	10
1.5 - 2.0	1.1 - 1.5	10	16

You can use standard as well as quick-blow or slow-blow fuses.

### 24.2 Leakage current

Earth leakage current less than 3.5 mA, AC.

Earth leakage current less than 10 mA, DC.

The leakage currents are measured in accordance with EN 61800-5-1:2007.

## 25. Technical data, three-phase motors

### 25.1 Supply voltage

Check that the supply voltage and frequency correspond to the values stated on the nameplate.

#### Recommended fuse size

- 3 x 380-500 V - 10 %/+ 10 %, 50/60 Hz, PE.

Motor size [HP]	Motor size [kW]	Minimum [A]	Maximum [A]
0.33 - 1.5	0.25 - 1.1	6	6
2.0	1.5	6	10
3.0	2.2	6	16
4.0	3	10	16
5.0	4	13	16
7.5	5.5	16	32
10	7.5	20	32
15	11	32	32

- 3 x 200-240 V - 10 %/+ 10 %, 50/60 Hz, PE.

Motor size [HP]	Motor size [kW]	Minimum [A]	Maximum [A]
1.5	1.1	10	20
2.0	1.5	10	20
3.0	2.2	13	35
4.0	3	16	35
5.0	4	25	35
7.5	5.5	32	35

You can use standard as well as quick-blow or slow-blow fuses.

## 25.2 Leakage current, AC

Speed [min <sup>-1</sup> ]	Power [HP]	Power [kW]	Mains voltage [V]	Leakage current [mA]
1400-2000 1450-2200	0.33 - 2.0	0.25 - 1.5	≤ 400	< 3.5
			> 400	< 5
	3.0 - 5.0	2.2 - 4	≤ 400	< 3.5
			> 400	< 3.5
2900-4000	7.5 - 10	5.5 - 7.5	≤ 400	< 3.5
			> 400	< 5
	0.33 - 3.0	0.25 - 2.2	≤ 400	< 3.5
			> 400	< 5
4.0 - 7.5	3 - 5.5	≤ 400	< 3.5	
		> 400	< 3.5	
4000-5900	10.0 - 15.0	7.5 - 11	≤ 400	< 3.5
			> 400	< 5
	0.33 - 3.0	0.25 - 2.2	≤ 400	< 3.5
			> 400	< 5
4.0 - 7.5	3 - 5.5	≤ 400	< 3.5	
		> 400	< 3.5	
10.0 - 15.0	7.5 - 11	≤ 400	< 3.5	
		> 400	< 5	

The leakage currents are measured without any load on the shaft and in accordance with EN 61800-5-1:2007.

## 26. Inputs and outputs

### Ground reference, GND

All voltages refer to GND.

All currents return to GND.

### Absolute maximum voltage and current limits

Exceeding the following electrical limits may result in severely reduced operating reliability and motor life:

Relay 1:

Maximum contact load: 250 VAC, 2 A or 30 VDC, 2 A.

Relay 2:

Maximum contact load: 30 VDC, 2 A.

GENI terminals: -5.5 to 9.0 VDC or less than 25 mADC.

Other input and output terminals: -0.5 to 26 VDC or less than 15 mADC.

### Digital inputs, DI

Internal pull-up current greater than 10 mA at  $V_i$  equal to 0 VDC.

Internal pull-up to 5 VDC; currentless for  $V_i$  greater than 5 VDC).

Low logic level:  $V_i$  less than 1.5 VDC.

High logic level:  $V_i$  greater than 3.0 VDC.

Hysteresis: No.

Screened cable: 0.5 - 1.5 mm<sup>2</sup>, 28-16 AWG.

Maximum cable length: 1640 ft (500 m).

### Open-collector digital outputs, OC

Current sinking capability: 75 mADC, no current sourcing.

Load types: Resistive or/and inductive.

Low-state output voltage at 75 mADC: Maximum 1.2 VDC.

Low-state output voltage at 10 mADC: Maximum 0.6 VDC.

Overcurrent protection: Yes.

Screened cable: 0.5 - 1.5 mm<sup>2</sup>, 28-16 AWG.

Maximum cable length: 1640 ft (500 m).

### Analog inputs, AI

Voltage signal ranges:

- 0.5 - 3.5 VDC, AL AU.
- 0-5 VDC, AU.
- 0-10 VDC, AU.

Voltage signal:  $R_i$  greater than 100 k $\Omega$  at 77 °F (25 °C).

Leak currents may occur at high operating temperatures. Keep the source impedance low.

Current signal ranges:

- 0-20 mADC, AU.
- 4-20 mADC, AL AU.

Current signal:  $R_i$  equal to 292  $\Omega$ .

Current overload protection: Yes. Change to voltage signal.

Measurement tolerance: - 0/+ 3 % of full scale (maximum-point coverage).

Screened cable: 0.5 - 1.5 mm<sup>2</sup>, 28-16 AWG.

Maximum cable length: 1640 ft (500 m), excl. potentiometer.

Potentiometer connected to +5 V, GND, any AI:

Use maximum 10 k $\Omega$ .

Maximum cable length: 100 m.

### Analog output, AO

Current sourcing capability only.

Voltage signal:

- Range: 0-10 VDC.
- Minimum load between AO and GND: 1 k $\Omega$ .
- Short-circuit protection: Yes.

Current signal:

- Ranges: 0-20 and 4-20 mADC.
- Maximum load between AO and GND: 500  $\Omega$ .
- Open-circuit protection: Yes.

Tolerance: - 0/+ 4 % of full scale (maximum-point coverage).

Screened cable: 0.5 - 1.5 mm<sup>2</sup>, 28-16 AWG.

Maximum cable length: 1640 ft (500 m).

### Pt100/1000 inputs, PT

Temperature range:

- Minimum -22 °F (-30 °C). 88  $\Omega$ /882  $\Omega$ .
- Maximum 356 °F (180 °C). 168  $\Omega$ /1685  $\Omega$ .

Measurement tolerance:  $\pm$  2.7 °F (1.5 °C).

Measurement resolution: < 0.54 °F (0.3 °C).

Automatic range detection, Pt100 or Pt1000: Yes.

Sensor fault alarm: Yes.

Screened cable: 0.5 - 1.5 mm<sup>2</sup>, 28-16 AWG.

Use Pt100 for short wires.

Use Pt1000 for long wires.

### LiqTec sensor inputs\*

Use Grundfos LiqTec sensor only.

Screened cable: 0.5 - 1.5 mm<sup>2</sup>, 28-16 AWG.

### Grundfos Digital Sensor input and output, GDS\*

Use Grundfos Digital Sensor only.

\* Not applicable for TPE, TPED pumps. The factory-fitted differential-pressure sensor for TPE, TPED Series 2000 is connected to this input.

### Power supplies

#### +5 V:

- Output voltage: 5 VDC - 5 %/+ 5 %.
- Maximum current: 50 mADC, sourcing only.
- Overload protection: Yes.

#### +24 V:

- Output voltage: 24 VDC - 5 %/+ 5 %.
- Maximum current: 60 mADC, sourcing only.
- Overload protection: Yes.

### Digital outputs, relays

Potential-free changeover contacts.

Minimum contact load when in use: 5 VDC, 10 mA.

Screened cable: 0.5 - 2.5 mm<sup>2</sup>, 28-12 AWG.

Maximum cable length: 1640 ft (500 m).

### Bus input

Grundfos GENIbus protocol, RS-485.

Screened 3-core cable: 0.5 - 1.5 mm<sup>2</sup>, 28-16 AWG.

Maximum cable length: 1640 ft (500 m).

## 27. Other technical data

### EMC (electromagnetic compatibility)

Standard used: EN 61800-3.

The table below shows the emission category of the motor.

C1 fulfils the requirements for residential areas.

**Note:** When connected to a public network, 11 kW motors do not comply with the partial weighted harmonic distortion (PWhd) requirements of EN 61000-3-12. If required by the distribution network operator, compliance can be obtained in the following way:

The impedance of the mains cables between the motor and the point of common coupling (PCC) must be equivalent to the impedance of a 164 ft (50 m) cable with a cross-section of 0.5 mm.

C3 fulfils the requirements for industrial areas.

**Note:** When the motors are installed in residential areas, supplementary measures may be required as the motors may cause radio interference.

Motor [HP]	Motor [kW]	Emission category	
		1450-2000 min <sup>-1</sup>	2900-4000 min <sup>-1</sup> 4000-5900 min <sup>-1</sup>
0.33	0.25	C1	C1
0.50	0.37	C1	C1
0.75	0.55	C1	C1
1.0	0.75	C1	C1
1.5	1.1	C1	C1
2.0	1.5	C1	C1
3.0	2.2	C1	C1
4.0	3	C1	C1
5.0	4	C1	C1
7.5	5.5	C3/C1*	C1
10.0	7.5	C3/C1*	C3/C1*
15.0	11	-	C3/C1*

\* C1, if equipped with an external Grundfos EMC filter.

Immunity: The motor fulfils the requirements for industrial areas.

Contact Grundfos for further information.

### Enclosure class

Standard: IP55 (IEC 34-5).

Optional: IP66 (IEC 34-5).

### Insulation class

F (IEC 85).

### Standby power consumption

5-10 W.

### Cable entries

Motor [HP]	Motor [kW]	Number and size of cable entries		
		1400-2000 1450-2200 [min <sup>-1</sup> ]	2900-4000 [min <sup>-1</sup> ]	4000-5900 [min <sup>-1</sup> ]
0.33 - 2.0	0.25 - 1.5	4xM20	4xM20	4xM20
3.0	2.2	1xM25 + 4xM20	4xM20	4xM20
4.0 - 5.0	3.0 - 4.0	1xM25 + 4xM20	1xM25 + 4xM20	1xM25 + 4xM20
7.5	5.5	1xM32 + 5xM20	1xM25 + 4xM20	1xM25 + 4xM20
10 - 15	7.5 - 11	1xM32 + 5xM20	1xM32 + 5xM20	1xM32 + 5xM20

### 27.1 Torques

Terminal	Thread size	Maximum torque [Nm]
L1, L2, L3, L, N	M4	2.35
NC, C1, C2, NO	M2.5	0.5
1 to 26 and A, Y, B	M2	0.5

## 27.2 Sound pressure level

Motor [HP]	Motor [kW]	Maximum speed stated on nameplate [min <sup>-1</sup> ]	Speed [min <sup>-1</sup> ]	Sound pressure level ISO 3743 [dB(A)]	
				1-ph motors	3-ph motors
0.33 - 1.0	0.25 - 0.75	2000	1500	37	37
			2000	43	43
		4000	3000	50	50
			4000	60	60
		5900	4000	58	58
			5900	68	68
1.5	1.1	2000	1500		37
			2000		43
		4000	3000	50	50
			4000	60	60
		5900	4000	58	58
			5900	68	68
2.0	1.5	2000	1500		42
			2000		47
		4000	3000	57	57
			4000	64	64
		5900	4000	58	58
			5900	68	68
3.0	2.2	2000	1500		48
			2000		55
		4000	3000		57
			4000		64
		5900	4000		58
			5900		68
4.0	3.0	2000	1500		48
			2000		55
		4000	3000		60
			4000		69
		5900	4000		64
			5900		74
5.0	4.0	2000	1500		48
			2000		55
		4000	3000		61
			4000		69
		5900	4000		64
			5900		74
7.5	5.5	2000	1500		58
			2000		61
		4000	3000		61
			4000		69
		5900	4000		64
			5900		74

Motor [HP]	Motor [kW]	Maximum speed stated on nameplate [min <sup>-1</sup> ]	Speed [min <sup>-1</sup> ]	Sound pressure level ISO 3743 [dB(A)]	
				1-ph motors	3-ph motors
10.0	7.5	2000	1500		58
			2000		61
		4000	3000		66
			4000		73
		5900	4000		69
			5900		79
15.0	11	4000	3000		66
			4000		73
		5900	4000		69
			5900		79

The grey fields indicate that the motor is not available in this MGE motor range.

## 28. Factory settings

- Function is enabled.
- Function is disabled.
- Function is not available.

Settings	NBE, NBSE, NKE, TPE, TPED	NBE, NBSE, NKE, TPE, TPED Series 2000	Function description on page
Setpoint	67 %	58 %	24
Operating mode	Normal	Normal	24
Control mode	Const. curve	Prop. pressure	24
Date and time	●	●	
"Buttons on product"	●	●	41
"Controller" ("Controller settings")			34
"Ti"	0.5	-	
"Kp"	0.5	-	
Operating range			36
"Min."	25 %	25 %	
"Max."	100 %	110 %	
"Ramps"	○	○	39
"Ramp-up"	1 second	1 second	
"Ramp-down"	3 seconds	3 seconds	
"Number" (Pump number)	1	1	40
"Radio communication"	●	●	40
Analog input 1	○	○	
Analog input 2	○	○	29
Analog input 3	○	○	
Built-in Grundfos sensor	-	●	30
Pt100/1000 input 1	○	○	
Pt100/1000 input 2	○	○	30
"Digital input 1"	○	○	
"Digital input 2"	○	○	31
"Digital in/output 3"	○	○	
"Digital in/output 4"	○	○	32
"Pulse flowmeter"	○	○	39
"Predefined setpoints"	○	○	38
Analog output	○	○	33
External setpoint function	○	○	38
Relay output 1	○	○	
Relay output 2	○	○	33
Limit 1 exceeded	○	○	
Limit 2 exceeded	○	○	38
"Standstill heating"	○	○	39
Motor bearing monitoring	○	○	40
"Pump name"	Grundfos	Grundfos	41
"Connection code"	-	-	42
"Unit configuration"	SI	SI	40

## 29. Disposing of the product

This product or parts of it must be disposed of in an environmentally sound way:

1. Use the public or private waste collection service.
2. If this is not possible, contact the nearest Grundfos company or service workshop.

## 1. Installation in the USA and Canada

**Note**

In order to maintain the cURus approval, follow these additional installation instructions.

The UL approval is according to UL 1004-1.

### 1.1 Electrical codes

#### For USA

This product complies with the Canadian Electrical Code and the US National Electrical Code.

This product has been tested according to the national standards for Electronically Protected Motors:

CSA 22.2 100.04: 2009 (applies to Canada only).

UL 1004-1: June 2011 (applies to USA only).

#### Pour le Canada

##### Codes de l'électricité

Ce produit est conforme au Code canadien de l'électricité et au Code national de l'électricité américain.

Ce produit a été testé selon les normes nationales s'appliquant aux moteurs protégés électroniquement:

CSA 22.2 100.04: 2009 (s'applique au Canada uniquement).

UL 1004-1: Juin 2011 (s'applique aux États-Unis uniquement).

### 1.2 Radio communication

#### For USA

This device complies with part 15 of the FCC rules and RSS210 of IC rules.

Operation is subject to the following two conditions:

- This device may not cause interference.
- This device must accept any interference, including interference that may cause undesired operation of the device.

#### Pour le Canada

##### Communication radio

Ce dispositif est conforme à la partie 15 des règles de la FCC et aux normes RSS210 de l'IC.

Son fonctionnement est soumis aux deux conditions suivantes:

- Ce dispositif ne doit pas provoquer de brouillage préjudiciable.
- Il doit accepter tout brouillage reçu, y compris le brouillage pouvant entraîner un mauvais fonctionnement.

### 1.3 Identification numbers

#### For USA

Grundfos Holding A/S

Contains FCC ID: OG3-RADIOM01-2G4.

#### For Canada

Grundfos Holding A/S

Model: RADIOMODULE 2G4

Contains IC: 10447A-RA2G4M01.

#### Pour le Canada

##### Numéros d'identification

Grundfos Holding A/S

Modèle: RADIOMODULE 2G4

Contient IC: 10447A-RA2G4M01.

#### Location of identification numbers

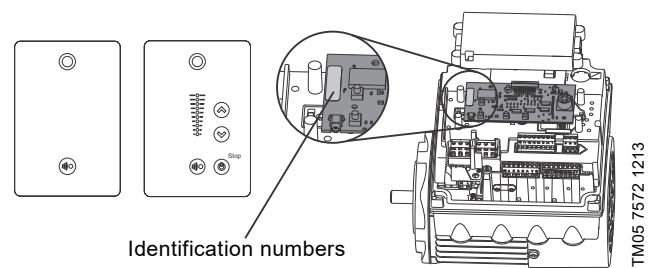

**Fig. 1** Identification numbers

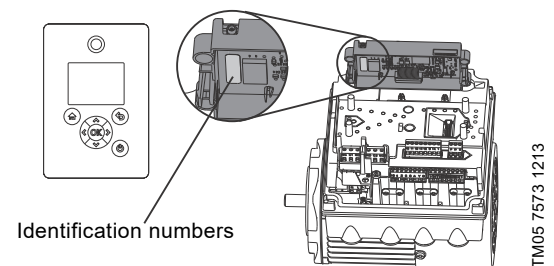

**Fig. 2** Identification numbers

## 1.4 Electrical connection

### 1.4.1 Conductors

Use 140/167 °F (60/75 °C) copper conductors only.

### 1.4.2 Torques

Maximum tightening torques for the terminals can be found in section [Torques](#), page 32.

### 1.4.3 Line reactors

Maximum line reactor size must not exceed 1.5 mH.

### 1.4.4 Fuse size/circuit breaker

If a short-circuit occurs, the pump can be used on a mains supply delivering not more than 5000 RMS symmetrical amperes, 600 V maximum.

Motor size [HP (kW)]	Fuse size	Circuit breaker type/model
0.5 to 3.0 (0.25 to 2.2 kW)	25 A	25 A / inverse time

### Fuses

When the motor is protected by fuses, they must be rated for 480 V. Maximum sizes are stated in the table above.

Motors up to and including 3.00 HP (2.20 kW) require class K5 UR fuses.

### Circuit breaker

When the pump is protected by a circuit breaker, this must be rated for a maximum voltage of 480 V. The circuit breaker must be of the "inverse time" type.

The interrupting rating (RMS symmetrical amperes) must not be less than the values stated in the table above.

### 1.4.5 Overload protection

Degree of overload protection provided internally by the drive, in percent of full-load current: 102 %.

## 1.5 Outdoor installation

According to UL 778/C22.2 No 108-14 pumps that are intended for outdoor use shall be marked enclosure type 3 and the product shall be tested with rated surface temperature down to -31 °F (-35 °C). The MLE enclosure is approved for type 3 or 4 and rated surface temperature down to 32 °F (0 °C), thus only for indoor use in UL 778/C22.2 No 108-14 pump applications. For ambient temperature during operation, see section [6.3 Ambient temperature](#).

## 1. Installation aux États-Unis et au Canada

**Nota**

Afin de respecter la norme UL / cUL, suivre ces instructions d'installation supplémentaires.

La norme UL est conforme à UL 1004-1.

### 1.1 Codes électriques

#### Pour les États-Unis et le Canada

Ce produit est conforme au Code canadien de l'électricité et au Code national de l'électricité des États-Unis.

Ce produit a été testé selon les normes nationales pour les moteurs protégés électroniquement :

CSA 22.2 100.04: 2009 (s'applique uniquement pour le Canada).

UL 1004-1: Juin 2011 (s'applique uniquement pour les États-Unis).

#### Pour le Canada

##### Codes de l'électricité

Ce produit est conforme au Code canadien de l'électricité et au Code national de l'électricité américain.

Ce produit a été testé selon les normes nationales s'appliquant aux moteurs protégés électroniquement:

CSA 22.2 100.04: 2009 (s'applique au Canada uniquement).

UL 1004-1: Juin 2011 (s'applique aux États-Unis uniquement).

### 1.2 Communication radio

#### Pour les États-Unis et le Canada

Cet appareil est conforme à la section 15 de la réglementation FCC et à RSS210 de la réglementation IC.

Le fonctionnement est soumis aux deux conditions suivantes :

- Cet appareil ne peut pas causer d'interférences.
- Cet appareil doit accepter toute interférence, y compris les interférences susceptibles de provoquer un fonctionnement indésirable de l'appareil.

#### Pour le Canada

##### Communication radio

Ce dispositif est conforme à la partie 15 des règles de la FCC et aux normes RSS210 de l'IC.

Son fonctionnement est soumis aux deux conditions suivantes:

- Ce dispositif ne doit pas provoquer de brouillage préjudiciable.
- Il doit accepter tout brouillage reçu, y compris le brouillage pouvant entraîner un mauvais fonctionnement.

### 1.3 Numéros d'identification

#### Pour les États-Unis

Grundfos Holding A/S

Contient ID FCC : OG3-RADIOM01-2G4.

#### Pour le Canada

Grundfos Holding A/S

Modèle : RADIOMODULE 2G4

Contient IC : 10447A-RA2G4M01.

#### Pour le Canada

##### Numéros d'identification

Grundfos Holding A/S

Modèle: RADIOMODULE 2G4

Contient IC: 10447A-RA2G4M01.

##### Emplacement des numéros d'identification

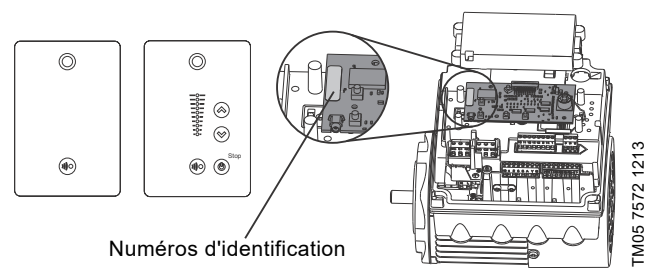

Fig. 1 Numéros d'identification

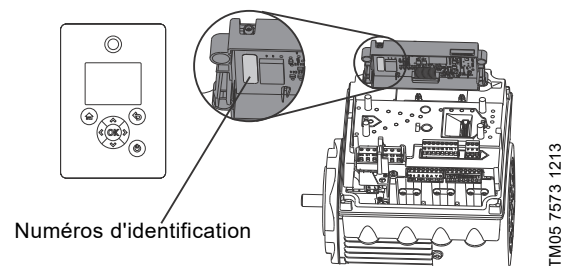

Fig. 2 Numéros d'identification

## 1.4 Branchement électrique

### 1.4.1 Conducteurs

Utiliser uniquement des conducteurs en cuivre, 140/167 °F (60/75 °C).

### 1.4.2 Couples de serrage

Les couples de serrage maximum pour les bornes sont disponibles à la section [Torques](#), page 30.

### 1.4.3 Réacteurs conduite

La taille maximale du réacteur de conduite ne doit pas dépasser 1.5 mH.

### 1.4.4 Dimension fusible/disjoncteur

Si un court-circuit se produit, la pompe peut être utilisée avec une alimentation électrique ne fournissant pas plus de 5 000 RMS ampères symétriques, 600 V max.

Puissance moteur [HP (kW)]	Taille de fusible	Type/modèle de disjoncteur
0.5 à 3.0 (0.25 à 2.2 kW)	25 A	25 A / à temporisation inverse

#### Fusibles

Lorsque la pompe est protégée par des fusibles, ils doivent supporter 480 V. Les tailles maximales sont indiquées dans le tableau ci-dessus.

Les moteurs d'une puissance inférieure ou égale à 3.00 HP (2.20 kW) nécessitent des fusibles de classe K5 UR.

#### Disjoncteur

Lorsque la pompe est protégée par un disjoncteur, celui-ci doit pouvoir supporter une tension maximale de 480 V. Le disjoncteur doit être de type « temporisation inverse ».

La valeur d'interruption assignée (ampères symétriques RMS) ne doit pas être inférieure aux valeurs indiquées dans le tableau ci-dessus.

### 1.4.5 Protection contre la surcharge

Degré de protection contre les surcharges fournies en interne par l'entraînement, en pourcentage de l'intensité à pleine charge : 102 %.

## 1.5 Installation extérieure

Selon la norme UL 778/C22.2 No 108-14, les pompes destinées à un usage extérieur doivent être marquées du type de boîtier 3 et le produit doit être testé avec une température de surface nominale jusqu'à -31 °F (-35 °C). Le boîtier MLE est homologué pour le type 3 ou 4 et sa température nominale jusqu'à 32 °F (0 °C), donc uniquement pour une utilisation en intérieur des applications de pompe UL 778/C22.2 No 108-14. Pour la température ambiante pendant le fonctionnement, voir la section [6.3 Ambient temperature](#).

## 1. Instalación en EE. UU. y Canadá

Respete las instrucciones de instalación complementarias descritas a continuación para preservar la aprobación cURus.

**Nota**

La aprobación UL cumple los requerimientos de la norma UL 1004-1.

### 1.1 Códigos eléctricos

#### Para EE. UU.

Este producto cumple los requerimientos de los códigos eléctricos nacionales de Canadá y EE. UU.

Este producto se ha sometido a ensayos conforme a los requerimientos de las normas nacionales para motores con protección electrónica:

CSA 22.2 100.04: 2009 (aplicable únicamente en Canadá).

UL 1004-1: junio de 2011 (aplicable únicamente en EE. UU.).

#### Pour le Canada

#### Codes de l'électricité

Ce produit est conforme au Code canadien de l'électricité et au Code national de l'électricité américain.

Ce produit a été testé selon les normes nationales s'appliquant aux moteurs protégés électroniquement:

CSA 22.2 100.04: 2009 (s'applique au Canada uniquement).

UL 1004-1: Juin 2011 (s'applique aux États-Unis uniquement).

### 1.2 Comunicación por radio

#### Para EE. UU.

Este dispositivo satisface los requerimientos establecidos en el apartado 15 de la normativa FCC y aquellos descritos en la norma RSS-210 del Ministerio de Industria de Canadá (IC).

Su operación se encuentra sujeta a las siguientes dos condiciones:

- Este dispositivo no puede causar interferencias.
- Este dispositivo debe aceptar cualquier interferencia recibida, incluidas aquellas que puedan causar una operación no deseada del dispositivo.

#### Pour le Canada

#### Communication radio

Ce dispositif est conforme à la partie 15 des règles de la FCC et aux normes RSS210 de l'IC.

Son fonctionnement est soumis aux deux conditions suivantes:

- Ce dispositif ne doit pas provoquer de brouillage préjudiciable.
- Il doit accepter tout brouillage reçu, y compris le brouillage pouvant entraîner un mauvais fonctionnement.

### 1.3 Códigos de identificación

#### Para EE. UU.

GRUNDFOS HOLDING A/S

Contiene el módulo con identificador FCC: OG3-RADIOM01-2G4.

#### Para Canadá

Grundfos Holding A/S

Modelo: RADIOMODULE 2G4

Contiene el módulo con identificador IC: 10447A-RA2G4M01.

#### Pour le Canada

#### Numéros d'identification

Grundfos Holding A/S

Modèle: RADIOMODULE 2G4

Contient IC: 10447A-RA2G4M01.

#### Ubicación de los códigos de identificación

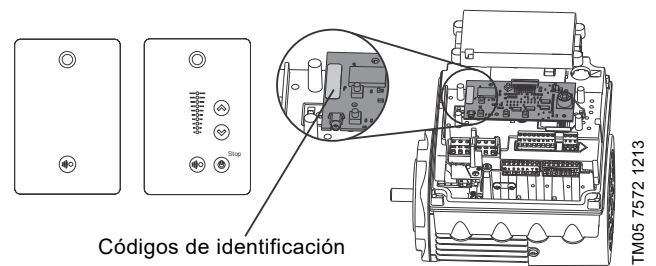

Fig. 1 Códigos de identificación

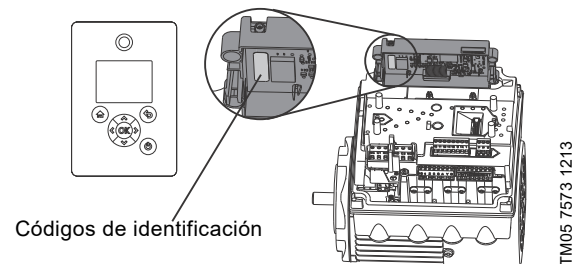

Fig. 2 Códigos de identificación

## 1.4 Conexión eléctrica

### 1.4.1 Conductores

Use sólo conductores de cobre aptos para una temperatura de 140/167 °F (60/75 °C).

### 1.4.2 Pares de ajuste

Los pares de ajuste máximos para las terminales se indican en la sección *Torques* (página 30).

### 1.4.3 Reactores de línea

El tamaño máximo de un reactor de línea no debe superar los 1.5 mH.

### 1.4.4 Tamaño de fusible/interruptor de circuito

Si se produce un cortocircuito, la bomba podrá operar conectada a una fuente de suministro eléctrico que no entregue más de 5000 amperes simétricos RMS a un máximo de 600 V.

Potencia del motor [HP (kW)]	Tamaño del fusible	Tipo/modelo de interruptor de circuito
0.5 - 3.0 (0.25 - 2.2 kW)	25 A	25 A/tiempo inverso

### Fusibles

Si el motor se protege empleando fusibles, estos deberán poseer una tensión nominal de 480 V. Los tamaños máximos se indican en la tabla anterior.

Los motores con potencias de hasta 3.00 HP (2.20 kW) requieren usar fusibles UR de clase K5.

### Interruptor de circuito

Si la bomba se protege empleando un interruptor de circuito, este deberá poseer una tensión nominal máxima de 480 V. El interruptor de circuito debe ser de "tiempo inverso".

El nivel nominal de interrupción (amperes simétricos RMS) no debe ser inferior a los valores indicados en la tabla anterior.

### 1.4.5 Protección contra sobrecarga

Grado de protección contra sobrecarga proporcionado internamente por la transmisión, en porcentaje de la corriente a plena carga: 102 %.

## 1.5 Instalación en exteriores

La norma UL 778/C22.2 n.º 108-14 exige que las bombas diseñadas para su uso en exteriores lleven marcado el tipo de carcasa "3" y que el producto se someta a ensayos con temperaturas superficiales de hasta -31 °F (-35 °C). La carcasa de las bombas MLE está aprobada como de tipo 3 o 4 y ofrece una temperatura superficial nominal de hasta 32 °F (0 °C); por lo tanto, sólo puede usarse en interiores y en aplicaciones con bombas que aparezcan descritas en la norma UL 778/C22.2 n.º 108-14. Para conocer los requerimientos de temperatura ambiente durante la operación, consulte la sección *6.3 Ambient temperature*.

**GRUNDFOS Kansas City**

9300 Loiret Blvd.  
Lenexa, Kansas 66219  
Phone: (913) 227-3400  
Fax: (913) 227-3500

[www.grundfos.us](http://www.grundfos.us)

**GRUNDFOS Canada**

2941 Brighton Road  
Oakville, Ontario L6H 6C9 Canada  
Phone: +1-905 829 9533  
Telefax: +1-905 829 9512

[www.grundfos.ca](http://www.grundfos.ca)

**GRUNDFOS México**

Boulevard TLC No. 15  
Parque Industrial Stiva Aeropuerto  
C.P. 66600 Apodaca, N.L. México  
Phone: 011-52-81-8144 4000  
Fax: 011-52-81-8144 4010

[www.grundfos.mx](http://www.grundfos.mx)

Order Online: [www.PumpCatalog.com](http://www.PumpCatalog.com)

<b>99470532</b> 11.2021
-------------------------

ECM: 1327399
--------------

Trademarks displayed in this material, including but not limited to Grundfos, the Grundfos logo and "be think innovate" are registered trademarks owned by The Grundfos Group. All rights reserved. © 2021 Grundfos Holding A/S, all rights reserved.