

# TPE2 (D), TPE3 (D)

Single-stage in-line pumps with integrated variable frequency drive

Installation and operating instructions



## Original installation and operating instructions

## CONTENTS

	Page		Page
<b>1. Limited warranty</b>	<b>3</b>	<b>14. Advanced control panel</b>	<b>21</b>
<b>2. Symbols used in this document</b>	<b>4</b>	<b>15. Home display</b>	<b>22</b>
2.1 Hazard statements	4	15.1 Start-up guide	22
2.2 Notes	4	15.2 Menu overview for advanced control panel	23
<b>3. Abbreviations and definitions</b>	<b>4</b>	<b>16. Grundfos GO</b>	<b>26</b>
<b>4. General information</b>	<b>5</b>	16.1 Communication	26
4.1 Nameplate	5	16.2 Menu overview for Grundfos GO main menus	27
4.2 Type key	6	<b>17. Description of functions</b>	<b>29</b>
<b>5. General description</b>	<b>7</b>	17.1 "Heat energy monitor"	29
5.1 Radio communication	7	17.2 Setpoint	29
5.2 Battery	7	17.3 Operating mode	29
<b>6. Receiving the product</b>	<b>7</b>	17.4 Set manual speed	30
6.1 Delivery	7	17.5 "Set user-defined speed"	30
6.2 Transporting the product	7	17.6 Control mode	30
6.3 Inspecting the product	7	17.7 "Proportional-pressure setup"	35
6.4 Handling the product	7	17.8 FLOW <sub>LIMIT</sub>	35
<b>7. Applications</b>	<b>8</b>	17.9 Automatic Night Setback	36
7.1 Pumped liquids	8	17.10 Analog inputs	36
<b>8. Mechanical installation</b>	<b>8</b>	17.11 Built-in Grundfos sensor	37
8.1 Pipes	9	17.12 Pt100/1000 inputs	38
8.2 Terminal box positions	9	17.13 Digital inputs	38
8.3 Fitting of pump head	10	17.14 Digital inputs/outputs	39
8.4 Base plate	11	17.15 Activation delay	40
8.5 Insulation	11	17.16 "Signal relay 1 and 2" (Relay outputs)	40
8.6 Frost protection	11	17.17 Analog output	41
8.7 Cable entries	11	17.18 "Controller"("Controller settings")	41
8.8 Ensuring motor cooling	11	17.19 Operating range	43
8.9 Outdoor installation	11	17.20 External setpoint function	43
<b>9. Electrical installation</b>	<b>11</b>	17.21 "Predefined setpoints"	45
9.1 Protection against electric shock, indirect contact	12	17.22 "Temperature influence"	45
9.2 Cable requirements	12	17.23 Limit-exceeded function	46
9.3 Mains supply	12	17.24 "Pulse flowmeter setup"	46
9.4 Additional protection	13	17.25 "Ramps"	47
9.5 Connection terminals	14	17.26 "Standstill heating"	47
9.6 Signal cables	15	17.27 Alarm handling	47
9.7 Bus connection cable	15	17.28 Motor bearing monitoring	47
<b>10. Startup</b>	<b>16</b>	17.29 "Service"	48
10.1 Flushing the pipe system	16	17.30 "Number" (Pump number)	48
10.2 Priming the pump	16	17.31 "Radio communication" (Enable/disable radio comm.)	48
10.3 Starting the pump	17	17.32 Language	48
10.4 Shaft seal run-in	17	17.33 "Date and time" (Set date and time)	48
<b>11. Operating conditions</b>	<b>17</b>	17.34 "Unit configuration" (Units)	48
11.1 Maximum number of starts and stops	17	17.35 "Buttons on product" (Enable/disable settings)	48
11.2 Alternating operation of twin-head pumps	17	17.36 Delete history	49
11.3 Liquid temperature	17	17.37 Define Home display	49
11.4 Ambient temperature	17	17.38 Display settings	49
11.5 Operating pressure or test pressure	18	17.39 "Store settings" (Store actual settings)	49
11.6 Inlet pressure	18	17.40 "Recall settings" (Recall stored settings)	49
11.7 Electrical data	18	17.41 "Undo"	49
11.8 Sound pressure level	18	17.42 "Pump name"	49
11.9 Environment	18	17.43 "Connection code"	49
11.10 Installation altitude	18	17.44 Run start-up guide	50
11.11 Humidity	18	17.45 Alarm log	50
11.12 Motor cooling	18	17.46 Warning log	50
<b>12. User interfaces</b>	<b>18</b>	17.47 Assist	50
<b>13. Standard control panel</b>	<b>19</b>	17.48 Assisted pump setup	50
13.1 Setpoint setting	19	17.49 Setup, analog input	51
		17.50 Setting of date and time	51
		17.51 "Multipump setup" (Setup of multi-pump system)	51
		17.52 Description of control mode	54
		17.53 Assisted fault advice	54
		<b>18. Selecting control mode</b>	<b>55</b>
		<b>19. Bus signal</b>	<b>57</b>
		<b>20. Priority of settings</b>	<b>57</b>

21.	<b>Grundfos Eye</b>	58
22.	<b>Signal relays</b>	59
23.	<b>Installing a communication interface module</b>	60
24.	<b>identification of functional module</b>	61
25.	<b>Identification of control panel</b>	61
26.	<b>Changing the position of the control panel</b>	62
27.	<b>Servicing the product</b>	63
27.1	Maintenance	63
27.2	Service	63
28.	<b>Cleaning the product</b>	63
29.	<b>Fault finding</b>	64
30.	<b>Megging</b>	65
31.	<b>Technical data, single-phase motors</b>	65
31.1	Supply voltage	65
31.2	Leakage current	65
32.	<b>Technical data, three-phase motors</b>	65
32.1	Supply voltage	65
32.2	Leakage current, AC	65
33.	<b>Inputs and outputs</b>	66
34.	<b>Other technical data</b>	67
34.1	Torques	67
34.2	Sound pressure level	67
35.	<b>Factory settings</b>	68
36.	<b>Disposing of the product</b>	69

## 1. Limited warranty

Products manufactured by GRUNDFOS PUMPS CORPORATION (Grundfos) are warranted to the original user only to be free of defects in material and workmanship for a period of 24 months from date of installation, but not more than 30 months from date of manufacture. Grundfos' liability under this warranty shall be limited to repairing or replacing at Grundfos' option, without charge, F.O.B. Grundfos' factory or authorized service station, any product of Grundfos' manufacture. Grundfos will not be liable for any costs of removal, installation, transportation, or any other charges which may arise in connection with a warranty claim. Products which are sold but not manufactured by Grundfos are subject to the warranty provided by the manufacturer of said products and not by Grundfos' warranty. Grundfos will not be liable for damage or wear to products caused by abnormal operating conditions, accident, abuse, misuse, unauthorized alteration or repair, or if the product was not installed in accordance with Grundfos' printed installation and operating instructions.

To obtain service under this warranty, the defective product must be returned to the distributor or dealer of Grundfos' products from which it was purchased together with proof of purchase and installation date, failure date, and supporting installation data. Unless otherwise provided, the distributor or dealer will contact Grundfos or an authorized service station for instructions. Any defective product to be returned to Grundfos or a service station must be sent freight prepaid; documentation supporting the warranty claim and/or a Return Material Authorization must be included if so instructed.

GRUNDFOS WILL NOT BE LIABLE FOR ANY INCIDENTAL OR CONSEQUENTIAL DAMAGES, LOSSES, OR EXPENSES ARISING FROM INSTALLATION, USE, OR ANY OTHER CAUSES. THERE ARE NO EXPRESS OR IMPLIED WARRANTIES, INCLUDING MERCHANTABILITY OR FITNESS FOR A PARTICULAR PURPOSE, WHICH EXTEND BEYOND THOSE WARRANTIES DESCRIBED OR REFERRED TO ABOVE.

Some jurisdictions do not allow the exclusion or limitation of incidental or consequential damages and some jurisdictions do not allow limit actions on how long implied warranties may last. Therefore, the above limitations or exclusions may not apply to you. This warranty gives you specific legal rights and you may also have other rights which vary from jurisdiction to jurisdiction.



Read this document before installing the product. Installation and operation must comply with local regulations and accepted codes of good practice.

## 2. Symbols used in this document

### 2.1 Hazard statements

The symbols and hazard statements below may appear in Grundfos installation and operating instructions, safety instructions and service instructions.



#### DANGER

Indicates a hazardous situation which, if not avoided, will result in death or serious personal injury.



#### WARNING

Indicates a hazardous situation which, if not avoided, could result in death or serious personal injury.



#### CAUTION

Indicates a hazardous situation which, if not avoided, could result in minor or moderate personal injury.

The hazard statements are structured in the following way:



#### SIGNAL WORD

##### Description of hazard

Consequence of ignoring the warning.  
- Action to avoid the hazard.

### 2.2 Notes

The symbols and notes below may appear in Grundfos installation and operating instructions, safety instructions and service instructions.



Observe these instructions for explosion-proof products.



A blue or grey circle with a white graphical symbol indicates that an action must be taken.



A red or grey circle with a diagonal bar, possibly with a black graphical symbol, indicates that an action must not be taken or must be stopped.



If these instructions are not observed, it may result in malfunction or damage to the equipment.



Tips and advice that make the work easier.

## 3. Abbreviations and definitions

AI	Analog input
AL	Alarm, out of range at lower limit
AO	Analog output
AU	Alarm, out of range at upper limit
CIM	Communication interface module
Current sinking	The ability to draw current into the terminal and guide it towards ground in the internal circuitry.
Current sourcing	The ability to push current out of the terminal and into an external load which must return it to ground.
DI	Digital input
DO	Digital output
ELCB	Earth-leakage circuit breaker
FM	Functional module
GDS	Grundfos Digital Sensor Factory-fitted sensor in some Grundfos pumps
GENIbus	Proprietary Grundfos fieldbus standard
GFCI	Ground fault circuit interrupter USA and Canada
GND	Ground.
Grundfos Eye	Status indicator light
LIVE	Low voltage with the risk of electric shock if the terminals are touched
OC	Open collector: Configurable open-collector output
PE	Protective ground
PELV	Protective extra-low voltage A voltage that cannot exceed ELV under normal conditions and under single-fault conditions, except ground faults in other circuits.
RCD	Residual-current device
SELV	Safety extra-low voltage A voltage that cannot exceed ELV under normal conditions and under single-fault conditions, including ground faults in other circuits.
TPE2	Single-head pump without factory-fitted differential-pressure and temperature sensor
TPE2 D	Twin-head pump without factory-fitted differential-pressure and temperature sensor
TPE3	Single-head pump with factory-fitted differential-pressure and temperature sensor
TPE3 D	Twin-head pump with factory-fitted differential-pressure and temperature sensor

## 4. General information

These installation and operating instructions apply to the Grundfos TPE2, TPE2 D and TPE3, TPE3 D pumps.

The pumps are fitted with frequency-controlled permanent-magnet motors for single-phase or three-phase power supply connection.

### 4.1 Nameplate

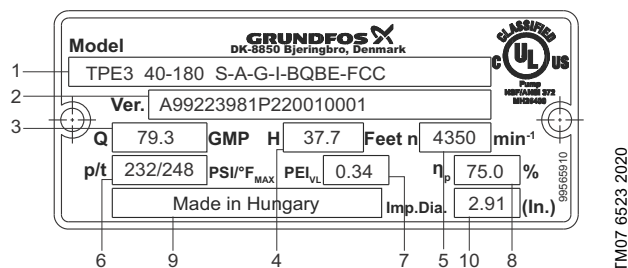

Fig. 1 Example of nameplate

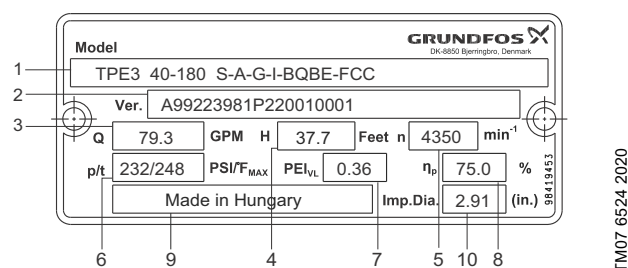

Fig. 2 Example of nameplate

Pos.	Description
1	Type designation
	Identification code
	A Service model
2	99223981 Product number
	P2 Production site code
	2001 Production year and week (YYWW)
	0001 Serial number
3	Nominal flow rate
4	Nominal pump head
5	Rated pump speed
6	Pressure rating and maximum temperature
	Pump Energy Index (PEI)
7	PEI <sub>CL</sub> : constant load
	PEI <sub>VL</sub> : variable load
8	Hydraulic efficiency at best efficiency point
9	Country of origin
10	Actual impeller diameter

4.2 Type key

Code	Example	TPE3	D	65	-150	S	-A	-G	-A	-BQQE	-G	C	B
	Pump range, electronically speed-controlled pump												
TPE2	Without built-in sensor												
TPE3	Built-in differential-pressure and temperature sensor												
	Twin-head pump												
	Nominal diameter of inlet and outlet ports [mm]												
	Maximum head [decimeters (dm)]												
S	Built-in differential-pressure and temperature sensor												
N	Without built-in sensor												
	Code for pump version:												
A	Basic version												
X	Special version												
	Code for pipe connection:												
G	ANSI flange												
	Code for materials:												
A	Basic version												
I	Stainless steel CF8 (1.4308) pump housing and motor stool												
	Code for shaft seal including other plastic and rubber pump parts, except the neck ring												
	Code for NEMA motors [hp (kW)]:												
C	0.33 (0.25)												
D	0.5 (0.37)												
E	0.75 (0.55)												
F	1 (0.75)												
G	1.5 (1.1)												
H	2 (1.5)												
I	3 (2.2)												
	Code for phase & voltage and other information:												
A	1 x 200-240 V												
B	3 x 200-240 V												
C	3 x 440-480 V												
D	3 x 380-500 V												
Y	Out of DOE scope (department of energy)												
	Code for speed variant [rpm]:												
A	1450-2200												
B	2900-4000												
C	4000-5900												

4.2.1 Codes for shaft seal

Code	Example	B	Q	B	E
	Grundfos type designation				
A	O-ring seal with fixed seal driver				
B	Rubber bellows seal				
D	O-ring seal, balanced				
G	Bellows seal with reduced seal faces				
R	O-ring seal with reduced seal faces				
	Material of rotating face				
A	Carbon, antimony-impregnated				
B	Carbon, resin-impregnated				
Q	Silicon carbide				
	Material of stationary seat				
B	Carbon, resin-impregnated				
Q	Silicon carbide				
U	Tungsten carbide				
	Material of secondary seal				
E	EPDM				
P	NBR rubber				
V	FKM				
F	FXM				

## 5. General description

The pumps are fitted with frequency-controller permanent-magnet motors for single-phase or three-phase power supply connection.

### 5.1 Radio communication

This product incorporates a radio module for remote control which is a class 1 device and can be used anywhere in the EU member states without restrictions.

For use in USA and Canada, see appendix [1.2 Radio communication](#), page 70.

Some variants of the product and products sold in China and Korea have no radio module.

This product can communicate with the Grundfos GO and other products of the same type via the built-in radio module.

In some cases, an external antenna may be required.

Only Grundfos-approved external antennas may be connected to this product, and only by a Grundfos-approved installer.

### 5.2 Battery

Pumps with the advanced functional module, FM 300, incorporate a Li-ion battery. The Li-ion battery complies with the Battery Directive (2006/66/EC). The battery does not contain mercury, lead and cadmium.

## 6. Receiving the product

### 6.1 Delivery

The pump is delivered from the factory in a carton with a wooden bottom, specially designed for transport by fork-lift truck or a similar vehicle.

### 6.2 Transporting the product

#### WARNING



#### Falling objects

- Death or serious personal injury
- Secure the product during transporting to prevent it from tilting or falling down.

#### CAUTION



#### Crushing of feet

- Minor or moderate personal injury
- Wear safety shoes when moving the product.

### 6.3 Inspecting the product

Before you install the product, do the following:

- Check that the product is as ordered.
- Check that no visible parts have been damaged.

If parts are damaged or missing, contact your local Grundfos sales company.

## 6.4 Handling the product

Observe local regulations setting limits for manual lifting or handling. The motor weight is stated on the nameplate.



#### CAUTION

#### Back injury

- Minor or moderate personal injury
- Use lifting equipment.



#### CAUTION

#### Crushing of feet

- Minor or moderate personal injury
- Wear safety shoes and attach lifting equipment to the motor eyebolts when handling the product.



Do not lift the product by the terminal box.

Lift the pump by means of nylon straps. See [figs 1 and 2](#).

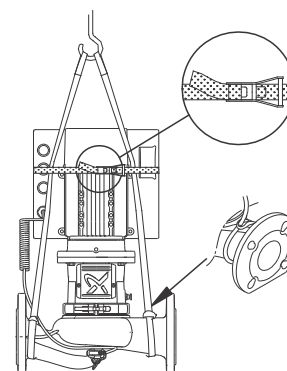

Fig. 1 TPE2, TPE3

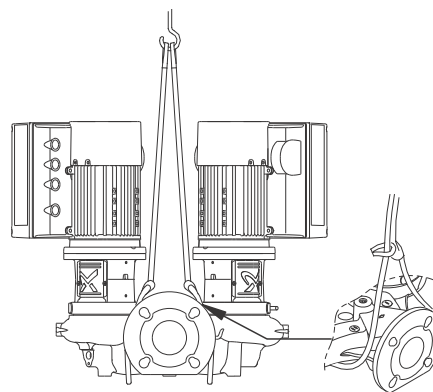

Fig. 2 TPE2 D, TPE3 D

TM05 7914 1613

TM05 7915 1613

## 7. Applications

The pumps are designed to circulate hot or cold water in residential, institutional and industrial applications:

- heating systems
- district heating plants
- central heating systems for blocks of flats
- air-conditioning systems
- cooling systems.

In addition, the pumps are used for liquid transfer and water supply in for instance:

- washing systems
- domestic hot-water systems
- industrial systems in general.

To ensure optimum operation, the dimensioning range of the system must fall within the performance range of the pump.

### 7.1 Pumped liquids

#### WARNING

##### Contact with hazardous liquids

Death or serious personal injury

- If the pump is used for a liquid which is injurious to health, it will be classified as contaminated. In such cases, take proper precautions to avoid injury to health when operating or working on the pump.
- Wear personal protection equipment.



The pump is suitable for thin, clean, non-aggressive and non-flammable liquids, not containing solid particles or fibers that may attack the pump mechanically or chemically.

Examples:

- Central heating system water. The water must meet the requirements of accepted standards on water quality in heating systems.
- Cooling liquids.
- Domestic hot water.
- Industrial liquids.
- Softened water.

The pumping of liquids with a density and/or kinematic viscosity higher than that of water will have the following effects:

- a considerable pressure drop
- a drop in hydraulic performance
- a rise in power consumption.

The EPDM O-rings fitted as standard are primarily suitable for water.

If the water contains minerals, synthetic oils or chemicals or other liquids than water are pumped, choose the O-rings accordingly.

## 8. Mechanical installation



#### WARNING

##### Hot or cold surface

Death or serious personal injury

- Make sure that no one can accidentally come into contact with hot or cold surfaces.



In order to maintain the UL mark, additional requirements apply to the equipment. See Appendix on page 70.

Install the pump in a dry well-ventilated, but frost-free position.

When installing pumps with oval bolt holes in the pump flange, use washers as shown in fig. 3.

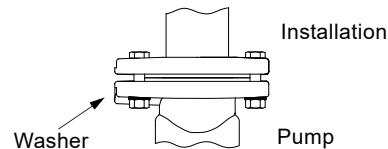

Fig. 3 Use of washers for oval bolt holes

Arrows on the pump casing show the direction of flow of liquid through the pump.

You can install the pump in horizontal or vertical pipes.



The motor must never fall below the horizontal plane.

For inspection and removal of motor or pump head, a clearance of 11.81" (300 mm) is required above the motor. See fig. 4.

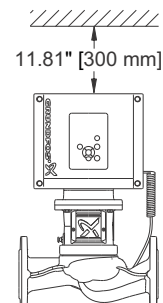

Fig. 4 Required clearance above the motor

TM01 0683 1997

TM06 0913 1613

Twin-head pumps installed in horizontal pipes must be fitted with an automatic air vent in the upper part of the pump casing. See fig. 5.

The automatic air vent is not supplied with the pump.

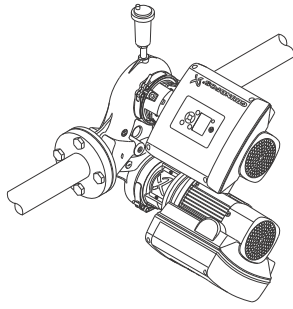

Fig. 5 Automatic air vent

If the liquid temperature falls below the ambient temperature or the pump is installed outside, condensation may form in the motor during standstill. In this case, make sure that one of the drain holes in the motor flange is open and points downwards. See fig. 6.

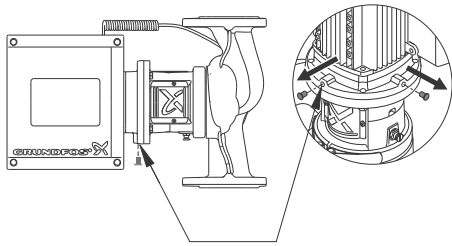

Fig. 6 Drain hole in motor flange

If twin-head pumps are used for pumping liquids with a temperature below 32 °F (0 °C), condensed water may freeze and cause the coupling to get stuck. You can solve the problem by installing heating elements. Whenever possible, install the pump with motor shaft in horizontal position. See fig. 5.



Observe the conditions in section [11. Operating conditions](#).

### 8.1 Pipes

Fit isolating valves on either side of the pump to avoid draining the system if the pump needs to be cleaned or repaired.

The pump is suitable for pipeline mounting, provided that the pipes are adequately supported on either side of the pump.

Single-head pumps are designed for pipeline mounting only.

Twin-head pumps are prepared for installation on a mounting bracket or base plate.

When installing the pipes, make sure that the pump casing is not stressed by the pipes.

The inlet and outlet pipes must be of an adequate size, taking the pump inlet pressure into account.

To avoid sediment build-up, do not fit the pump at the lowest point of the system.

Install the pipes so that air locks are avoided, especially on the inlet side of the pump. See fig. 7.

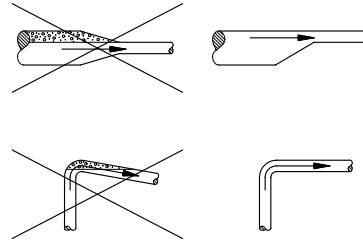

Fig. 7 Correct pipes on the inlet side of the pump



The pump must not run against a closed outlet valve as this will cause an increase in temperature or formation of steam in the pump, which may cause damage to the pump.

If there is any risk of the pump running against a closed outlet valve, ensure a minimum liquid flow through the pump by connecting a bypass or a drain to the outlet pipe. The drain can for instance be connected to a tank. A minimum flow rate of 10 % of the flow rate at maximum efficiency is needed at all times.

Flow rate and head at maximum efficiency are stated on the pump nameplate.

### 8.2 Terminal box positions

#### DANGER

##### Electric shock



Death or serious personal injury

- Switch off the power supply to the motor and to the signal relays. Wait at least 5 minutes before you make any connections in the terminal box. Make sure that the power supply cannot be accidentally switched on.

#### WARNING

##### Hazardous liquids



Death or serious personal injury

- If the pump is used for a liquid which is injurious to health, it will be classified as contaminated. In such case, take proper precautions to avoid injury to health when operating or working on the pump.
- Wear personal protection equipment.

#### WARNING

##### Falling objects



Death or serious personal injury

- If the pump head has been lifted partly or completely from the pump casing, pay special attention when fitting the pump head again.

#### CAUTION

##### Crushing of feet



Minor or moderate personal injury

- Wear safety shoes.
- Pay special attention that the pump head does not fall down when loosening the clamp. See fig. 8.

#### WARNING

##### Pressurised system



Death or serious personal injury

- Pay special attention to escaping vapor when loosening the clamp. See fig. 8.
- Wear personal protection equipment.

You can turn the terminal box to any position.

Change the terminal box position as follows:

TM05 7983 1713

TM05 7917 1613

TM00 2263 0195

1. Loosen the clamp securing the pump head to the casing. See fig. 8.

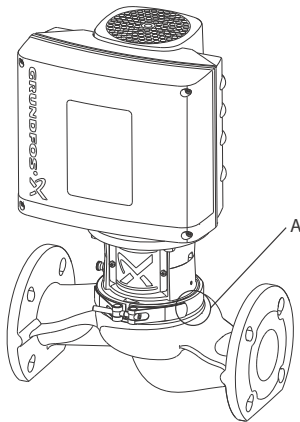

Fig. 8 Clamp (A)

2. Turn the pump head to the required position.
3. Check the following before you tighten the clamp:
  - The contact face of the pumping casing and that of the pump head must be in full contact.
  - The clamp must be positioned correctly in the flange recess of both the pump head and the pump casing. See fig. 11.

Torque: 5.9 lbf-ft (± 0.75) (8 Nm (± 1)).

### 8.3 Fitting of pump head

**DANGER**

**Electric shock**



Death or serious personal injury

- Switch off the power supply to the motor and to the signal relays. Wait at least 5 minutes before you make any connections in the terminal box. Make sure that the power supply cannot be accidentally switched on.

**WARNING**

**Falling objects**



Death or serious personal injury

- If the pump head has been lifted partly or completely from the pump casing, pay special attention when fitting the pump head again.

**CAUTION**

**Crushing of feet**



Minor or moderate personal injury

- Wear safety shoes.
- Pay special attention that the pump head does not fall down when loosening the clamp. See fig. 8.

**WARNING**

**Pressurised system**



Death or serious personal injury

- Pay special attention to any escaping vapor when loosening the clamp. See fig. 8.
- Wear personal protection equipment.

If for some reasons the pump head has been lifted from the pump casing, follow the following procedure in order to mount the pump head correctly:

1. Visually check that the neck ring is centered in the pump casing. See fig. 9.

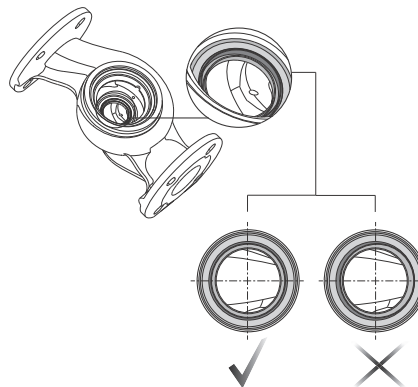

Fig. 9 Centering of neck ring

2. Gently lower the pump head with rotor shaft and impeller into the pump casing. See fig. 10.

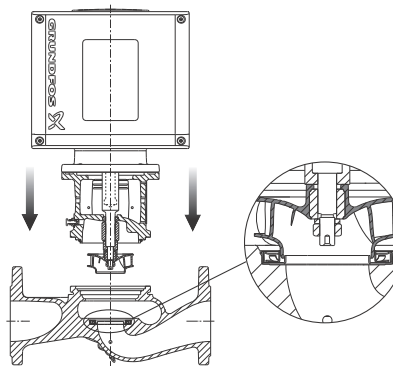

Fig. 10 Lowering of pump head

3. Check the following before you tighten the clamp:
  - The contact face of the pump casing and that of the pump head must be in full contact.
  - The clamp must be positioned correctly in the flange recess of both the pump head and the pump casing. See fig. 11.

Torque: 5.9 lbf-ft (± 0.75) (8 Nm (± 1)).

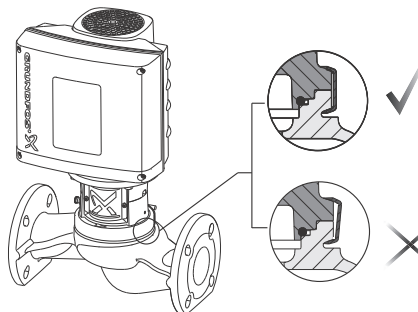

Fig. 11 Positioning of clamp ring

### 8.4 Base plate

Twin-head pumps have tapped holes in the bottom of the pump casing. You can use the holes for mounting a base plate.

### 8.5 Insulation



Do not insulate the motor stool as this will trap any vapor escaping from the shaft seal, thus causing corrosion. Covering the motor stool with insulation will also make inspection and service difficult.

Follow the guidelines in fig. 12 when insulating the pump.

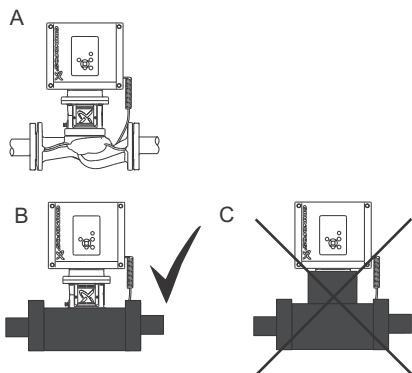

Fig. 12 Insulation of TPE2, TPE3 pumps

TM05 7918 1613

Pos.	Description
A	Without insulation
B	Correct insulation
C	Incorrect insulation

### 8.6 Frost protection

Drain pumps which are not being used during periods of frost to avoid damage.

### 8.7 Cable entries

See the size of the cable entries in section 34. [Other technical data](#).

### 8.8 Ensuring motor cooling

Leave at least 2.0" (50 mm) between the end of the fan cover and a wall or other fixed objects. See fig. 13.

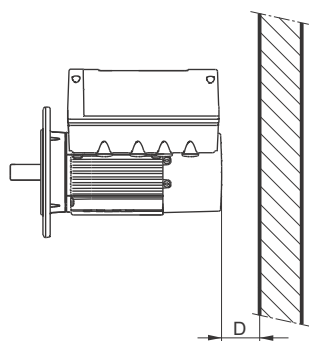

Fig. 13 Minimum distance, D, from the motor to a wall or other fixed objects

TM05 5236 3512

### 8.9 Outdoor installation

If you install the motor outdoors, provide the motor with a cover and open the drain holes to avoid condensation on the electronic components. See fig. 14.



When lifting a cover to the motor, observe the guidelines in section 8.8 [Ensuring motor cooling](#).

The cover must be sufficiently large to ensure that the motor is not exposed to direct sunlight, rain or snow. Grundfos does not supply covers. We therefore recommend that you have a cover built for the specific application. In areas with high humidity, we recommend that you connect the motor permanently to the power supply and activate the built-in standstill heating function. See section 17.26 ["Standstill heating"](#).

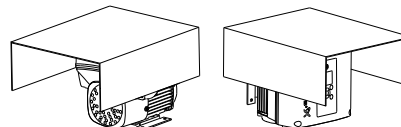

Fig. 14 Examples of covers, not supplied by Grundfos

TM05 3496 3512



In order to maintain the UL mark, additional requirements apply to the equipment. See Appendix 1. [Installation in the USA and Canada](#) on page 70.

## 9. Electrical installation

#### DANGER

#### Electric shock



Death or serious personal injury

- Switch off the power supply to the motor and to the signal relays. Wait at least 5 minutes before you make any connections in the terminal box. Make sure that the power supply cannot be accidentally switched on.

#### DANGER

#### Electric shock



Death or serious personal injury

- Check that the supply voltage and frequency correspond to the values stated on the nameplate.

If the power supply cable is damaged, it must be replaced by the manufacturer, the manufacturer's service partner or a similarly qualified person.

The user or the installer is responsible for the installation of correct grounding and protection according to local regulations. All operations must be carried out by a qualified electrician.

The product should be installed according to National Electrical Code (NEC) requirements.

### 9.1 Protection against electric shock, indirect contact



**WARNING**

**Electric shock**

- Death or serious personal injury
- Connect the motor to ground and provide protection against indirect contact in accordance with local regulations.

Ground conductors must always have a yellow and green, PE, or yellow, green and blue, PEN, color marking.

#### 9.1.1 Protection against mains voltage transients

The motor is protected against mains voltage transients in accordance with EN 61800-3.

#### 9.1.2 Motor protection

The motor requires no external motor protection. The motor incorporates thermal protection against slow overloading and blocking.

### 9.2 Cable requirements

#### 9.2.1 Cable cross-section



**DANGER**

**Electric shock**

- Death or serious personal injury
- Always comply with local regulations as to cable cross-sections.

1 x 200-230 V

Power [hp (kW)]	Conductor type	Cross section	
		[mm <sup>2</sup> ]	[AWG]
0.33 - 3.0 (0.25 - 2.2)	Solid	1.5 - 2.5	16-12
	Stranded	1.5 - 2.5	16-12

3 x 440-480 V

Power [hp (kW)]	Conductor type	Cross section	
		[mm <sup>2</sup> ]	[AWG]
0.33 - 3.0 (0.25 - 2.2)	Solid	1.5 - 10	16-8
	Stranded	1.5 - 10	16-8
4.0 - 15 (3.0 - 11)	Solid	2.5 - 10	14-8
	Stranded	2.5 - 10	14-8

3 x 200-240 V

Power [hp (kW)]	Conductor type	Cross section	
		[mm <sup>2</sup> ]	[AWG]
1.5 - 2.0 (1.1 - 1.5)	Solid	1.5 - 10	16-8
	Stranded	1.5 - 10	16-8
3.0 - 7.5 (2.2 - 5.5)	Solid	2.5 - 10	14-8
	Stranded	2.5 - 10	14-8

#### 9.2.2 Conductors

**Type**

Stranded or solid copper conductors.

**Temperature rating**

Temperature rating for conductor insulation: 140 °F (60 °C).

Temperature rating for outer cable sheath: 167 °F (75 °C).

### 9.3 Mains supply



**DANGER**

**Electric shock**

- Death or serious personal injury
- Use the recommended fuse size. See sections [31.1 Supply voltage](#) and [32.1 Supply voltage](#).

#### 9.3.1 Single-phase supply voltage

- 1 x 200-240 V - 10 %/+ 10 %, 60 Hz, PE.

Check that the supply voltage and frequency correspond to the values stated on the nameplate.



If you want to supply the motor through an IT network, make sure that you have a suitable motor variant. If you are in doubt, contact Grundfos.

The wires in the motor terminal box must be as short as possible. Except from this is the separated grounding conductor which must be so long that it is the last one to be disconnected in case the cable is inadvertently pulled out of the cable entry.

For maximum feeder overcurrent protective device (FOPD) ratings, see section [31.1 Supply voltage](#).

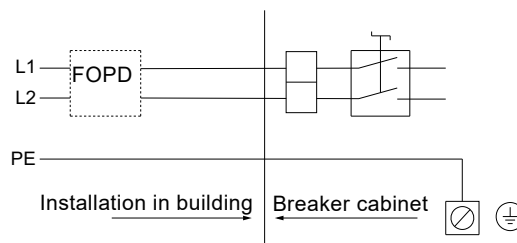

Fig. 15 Example of a mains-connected motor with feeder overcurrent protective device

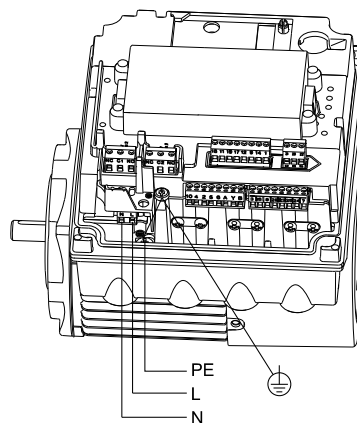

Fig. 16 Power supply connection, single-phase motors

TM07 2016 1520

TM05 3494 1512

### 9.3.2 Three-phase supply voltage

Three-phase motors are available for the voltages below:

- 3 x 440-480 V - 10 %/+ 10 %, 60 Hz, PE.
- 3 x 200-240 V - 10 %/+ 10 %, 60 Hz, PE.

Check that the supply voltage and frequency correspond to the values stated on the nameplate.

The wires in the motor terminal box must be as short as possible. Excepted from this is the separated grounding conductor which must be so long that it is the last one to be disconnected in case the cable is inadvertently pulled out of the cable entry.

In order to avoid loose connections, ensure that the terminal block for L1, L2 and L3 is pressed home in its socket when the supply cable has been connected.

For feeder overcurrent protective device ratings, see section [32.1 Supply voltage](#).



If you want to supply the motor through an IT network, make sure that you have a suitable motor variant. If you are in doubt, contact Grundfos.

Only the following motors can be supplied through an IT network:

- Motors with speed of 1450-2000/2200 rpm and up to 2.0 hp (1.5 kW)
- Motors with speed of 2900-4000 rpm or 4000-5900 rpm and up to 3.0 hp (2.2 kW).



Corner grounding is not allowed for supply voltage above 3 x 240 V and 3 x 480 V, 60 Hz.

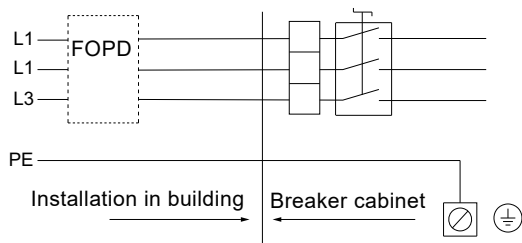

Fig. 17 Example of a mains-connected motor with feeder overcurrent protective device

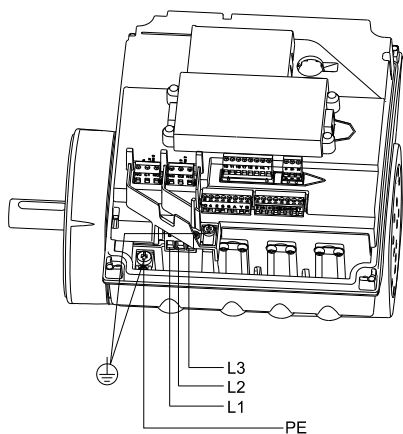

Fig. 18 Power supply connection, three-phase motors

### 9.4 Additional protection

The total leakage current of all the electrical equipment in the installation must be taken into account. You can find the leakage current of the motor in sections [32.2 Leakage current, AC](#).

The product can cause a direct current in the protective ground conductor.

#### Overvoltage and undervoltage protection

Overvoltage and undervoltage may occur in case of unstable power supply or a faulty installation. The motor is stopped if the motor falls outside the permissible voltage range. The motor restarts automatically when the voltage is again within the permissible voltage range. Therefore, no additional protection relay is required.



The motor is protected against transients from the power supply according to EN 61800-3. In areas with high lightning intensity, we recommend external lightning protection.

#### Overload protection

If the upper load limit is exceeded, the motor automatically compensates for this by reducing the speed and stops if the overload condition persists.

The motor remains stopped for a set period. After this period, the motor automatically attempts to restart. The overload protection prevents damage to the motor. Consequently, no additional motor protection is required.

#### Overtemperature protection

The electronic unit has a built-in temperature sensor as an additional protection. When the temperature rises above a certain level, the motor automatically compensates for this by reducing the speed and stops if the temperature keeps rising. The motor remains stopped for a set period. After this period, the motor automatically attempts to restart.

#### Protection against phase unbalance

Three-phase motors must be connected to a power supply with a quality corresponding to IEC 60146-1-1, class C, to ensure correct motor operation at phase unbalance. This also ensures long life of the components.

TM07 6350 1520

TM05 3495 1512

### 9.5 Connection terminals

The descriptions and terminal overviews in this section apply to both single-phase and three-phase motors.

For maximum tightening, see section 34.1 *Torques*.

#### 9.5.1 Connection terminals, advanced functional module, FM 300

The advanced module has three connections:

- Three analog inputs.
- One analog output.
- Two dedicated digital inputs.
- Two configurable digital inputs or open-collector outputs.
- Input and output for Grundfos Digital Sensor. The input and output are not applicable for TPE2, TPE2 D pumps. The built-in sensors for TPE3, TPE3 D pumps is connected to this input.
- Two Pt100/1000 inputs.  
For some pumps, the built-in temperature sensor is connected to Pt100/1000 input 1 (terminals 17 and 18).
- Two LiqTec sensor inputs.
- Two signal relay outputs.
- GENIbus connection.

See fig. 19.



Digital input 1 is factory-set to be start-stop input where open circuit results in stop. A jumper has been factory-fitted between terminals 2 and 6. Remove the jumper if digital input 1 is to be used as external start-stop or any other external function.

#### DANGER

#### Electric shock

Death or serious personal injury

- Make sure that the wires to be connected to the connection groups below are separated from each other by reinforced insulation in their entire lengths.



- Inputs and outputs  
All inputs and outputs are internally separated from the mains-conducting parts by reinforced insulation and galvanically separated from other circuits.  
All control terminals are supplied by protective extra-low voltage, PELV, thus ensuring protection against electronic shock.
- Signal relay outputs  
– Signal relay 1:  
LIVE:  
You can connect supply voltages up to 250 VAC.  
PELV:  
The output is galvanically separated from other circuits. Therefore, you can connect the supply voltage or protective extra-low voltage to the output as desired.  
– Signal relay 2:  
PELV:  
The output is galvanically separated from other circuits. Therefore, you can connect the supply voltage or protective extra-low voltage to the output as desired.
- Power supply, terminals N, PE, L or L1, L2, L3, PE.

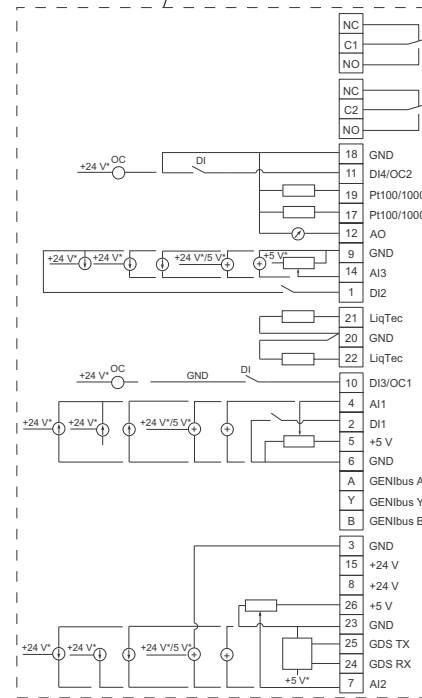
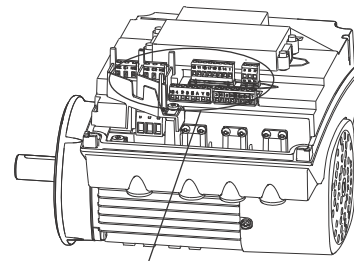

\* If you use an external supply source, make sure that there is a connection to ground.

Fig. 19 Connection terminals, FM 300

Terminal	Type	Function
NC	Normally closed contact	Signal relay 1 LIVE or PELV
C1	Common	
NO	Normally open contact	
NC	Normally closed contact	Signal relay 2 PELV only
C2	Common	
NO	Normally open contact	
18	GND	Ground
11	DI4/OC2	Digital input and output, configurable. Open collector: Max. 24 V resistive or inductive.
19	Pt100/1000 input 2	Pt100/1000 sensor input
17	Pt100/1000 input 1	Pt100/1000 sensor input
12	AO	Analog output: 0-20 mA / 4-20 mA 0-10 V
9	GND	Ground

TM05 3509 3512

Terminal	Type	Function
14	AI3	Analog input: 0-20 mA / 4-20 mA 0-10 V
1	DI2	Digital input, configurable
21	LiqTec sensor input 1	LiqTec sensor input white conductor
20	GND	Ground brown and black conductors
22	LiqTec sensor input 2	LiqTec sensor input blue conductor
10	DI3/OC1	Digital input or output, configurable. Open collector: maximum 24 V resistive or inductive.
4	AI1	Analog input: 0-20 mA / 4-20 mA 0.5 - 3.5 V / 0-5 V / 0-10 V
2	DI1	Digital input, configurable
5	+5 V	Supply to potentiometer and sensor
6	GND	Ground
A	GENIbus, A	GENIbus, A (+)
Y	GENIbus, Y	GENIbus, GND
B	GENIbus, B	GENIbus, B (-)
3	GND	Ground
15	+24 V	Supply
8	+24 V	Supply
26	+5 V	Supply to potentiometer and sensor
23	GND	Ground
25	GDS TX	Grundfos Digital Sensor output
24	GDS RX	Grundfos Digital Sensor input
7	AI2	Analog input: 0-20 mA / 4-20 mA 0.5 - 3.5 V / 0-5 V / 0-10 V

## 9.6 Signal cables

- Use screened cables with a cross-sectional area of minimum 20 AWG (0.5 mm<sup>2</sup>) and maximum 16 AWG (1.5 mm<sup>2</sup>) for external on/off switch, digital inputs, setpoint and sensor signals.
- Connect the screens of the cable to frame at both ends with good connection. The screens must be as close as possible to the terminals. See fig. 20.

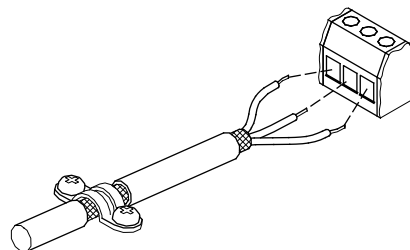

Fig. 20 Stripped cable with screen and wire connections

- Always tighten screws for frame connections whether a cable is fitted or not.
- The wires in the motor terminal box must be as short as possible.

## 9.7 Bus connection cable

### 9.7.1 New installations

For the bus connection, use a screened 3-core cable with a cross-sectional area of minimum 20 AWG (0.5 mm<sup>2</sup>) and maximum 16 AWG (1.5 mm<sup>2</sup>).

- If the motor is connected to a unit with a cable clamp which is identical to the one on the motor, connect the screen to this cable clamp.
- If the unit has no cable clamp as shown in fig. 21, leave the screen unconnected at his end.

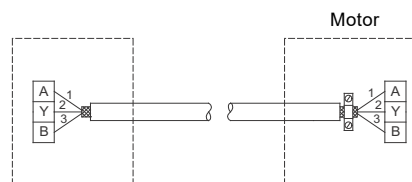

Fig. 21 Connection with screened 3-core cable

### 9.7.2 Replacing a motor

- If you have used a screened 2-core cable in the existing installation, connect the cable as shown in fig. 22.

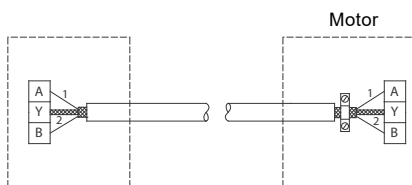

Fig. 22 Connection with screened 2-core cable

- If you have used a screened 3-core cable in the existing installation, follow the instructions in section 9.7.1 *New installations*.

TM02 1325 4402

TM05 3973 1812

TM02 8842 0904

## 10. Startup

### 10.1 Flushing the pipe system



Before starting up the pump for the first time, clean the pipe system thoroughly by flushing it and filling it with clean water.



Do not use the pump for flushing the pipe system. The warranty does not cover any damage caused by flushing the pipe system by means of the pump.

### 10.2 Priming the pump



Fill the pump with liquid and vent the pump before starting the pump. To ensure correct venting, the vent screw must point upwards.

#### Closed system or open systems where the liquid level is above the pump inlet

1. Close the outlet isolating valve and loosen the vent screw in the motor stool. See fig. 23.

#### WARNING

##### Escaping hot or cold liquids



Death or serious personal injury

- Pay attention to the direction of the vent hole, and make sure that the escaping hot or cold liquid does not cause injury to persons or damage to the equipment.
- Wear personal protection equipment.

2. Slowly open the isolating valve in the inlet pipe until a steady stream of liquid runs out of the vent hole.
3. Tighten the vent screw and completely open the isolating valve(s).

#### Open systems where the liquid level is below the pump inlet

Make sure that the inlet pipe and the pump is filled with liquid and vented before you start the pump.

1. Close the outlet isolating valve and open the isolating valve in the inlet pipe.
2. Loosen the vent screw. See fig. 23.
3. Remove the plug from one of the pump flanges, depending on the pump location.
4. Pour liquid through the priming port until the inlet pipe and the pump are filled with liquid.
5. Replace the plug and tighten securely.
6. Tighten the vent screw.

You can fill the inlet pipe with liquid and vent it before you connect it to the pump. You can also install a priming device before the pump.

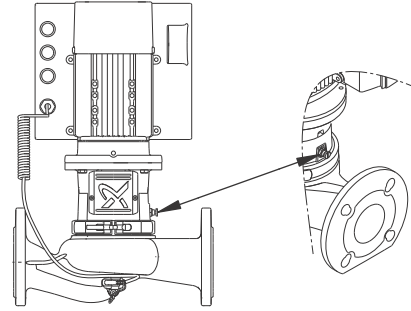

Fig. 23 Position of vent screw

### 10.3 Starting the pump

1. Before starting the pump, completely open the isolating valve on the inlet side of the pump and leave the outlet isolating valve almost closed.
2. Start the pump. See section [12. User interfaces](#).
3. Vent the pump by loosening the vent screw in the motor stool until a steady stream of liquid runs out of the vent hole. See fig. [23](#).

#### WARNING

##### Escaping hot or cold liquids



Death or serious personal injury

- Pay attention to the direction of the vent hole, and make sure that the escaping hot or cold liquid does not cause injury to persons or damage to the equipment.
- Wear personal protection equipment.

4. When the pipe system has been filled with liquid, slowly open the outlet isolating valve until it is completely open.

### 10.4 Shaft seal run-in

The seal faces are lubricated by the pumped liquid, meaning that there may be a certain amount of leakage from the shaft seal.

When the pump is started up for the first time, or when a new shaft seal is installed, a certain run-in period is required before the leakage is reduced to an acceptable level. The time required for this depends on the operating conditions, i.e. every time the operating conditions change, a new run-in period will be started. Under normal conditions, the leaking liquid will evaporate. As a result, no leakage will be detected.

However, liquids such as kerosene will not evaporate. The leakage may therefore be seen as a shaft seal failure.

## 11. Operating conditions

### 11.1 Maximum number of starts and stops

The number of starts and stops via the power supply must not exceed four times per hour.

When switched on via the power supply, the pump will start after approximately 5 seconds.

If a higher number of starts and stops is desired, use the input for external start/stop when starting or stopping the pump.

When started via an external on/off switch, the pump will start immediately.

### 11.2 Alternating operation of twin-head pumps

On twin-head pumps, the duty and backup pumps must be alternated on a regular basis, i.e. once a week, to ensure an even distribution of the operating hours on both pumps. The pumps alternate automatically. See section [17.51 "Multipump setup" \(Setup of multi-pump system\)](#).

If twin-head pumps are used for pumping domestic hot water, the duty and backup pumps must be alternated on a regular basis, i.e. once a day, to avoid blocking of the backup pump due to deposits such as calcareous deposits. The pumps alternate automatically. See section [17.51 "Multipump setup" \(Setup of multi-pump system\)](#).

### 11.3 Liquid temperature

-13 °F (-25 °C) up to +248 °F (+120 °C).

The maximum liquid temperature depends on the shaft seal type and the pump type.

Depending on the cast-iron version and the pump application, the maximum liquid temperature may be limited by local regulations and laws.

The maximum liquid temperature is stated on the pump nameplate.



If the pump is used for liquids at high temperatures, the life of the shaft seal and the built-in Grundfos sensor may be reduced.

### 11.4 Ambient temperature

#### 11.4.1 Ambient temperature during storage and transportation

Minimum: -22 °F (-30 °C).

Maximum: 140 °F (60 °C).

#### 11.4.2 Ambient temperature during operation

	3 x 200-240 V	1 x 200-240 V 3 x 440-480 V
Minimum	-4 °F (-20 °C)	-4 °F (-20 °C)
Maximum	104 °F (40 °C)	122 °F (50 °C)

The motor can operate with the rated power output, P2, at 122 °F (50 °C), but continuous operation at higher temperatures reduces the expected product life. If the motor is to operate at ambient temperatures between 122 and 140 °F (50 and 60 °C), select an oversized motor. Contact Grundfos for further information.

## 11.5 Operating pressure or test pressure

The pressure test has been made with water containing anti-corrosive additives at a temperature of 68 °F (20 °C).

Operating pressure		Test pressure	
[bar]	[psi]	[bar]	[psi]
10.3	150	15.5	225

## 11.6 Inlet pressure

To ensure optimum and quiet pump operation, the inlet pressure, system pressure, must be adjusted correctly. See the table on page 72.

For the calculation of specific inlet pressures, contact the local Grundfos company.

## 11.7 Electrical data

See sections 31. *Technical data, single-phase motors* and 32. *Technical data, three-phase motors*.

For specific motor data, see the motor nameplate.

## 11.8 Sound pressure level

See section 34.2 *Sound pressure level*.

## 11.9 Environment

Non-aggressive and non-explosive atmosphere.

## 11.10 Installation altitude

Installation altitude is the height above sea level of the installation site.

Motors installed up to 3281 ft (1000 m) above sea level can be loaded 100 %.

The motors can be installed up to 6560 ft (2000 m) above sea level.



Motors installed more than 3281 ft (1000 m) above sea level must not be fully loaded due to the low density and consequent low cooling effect of the air.

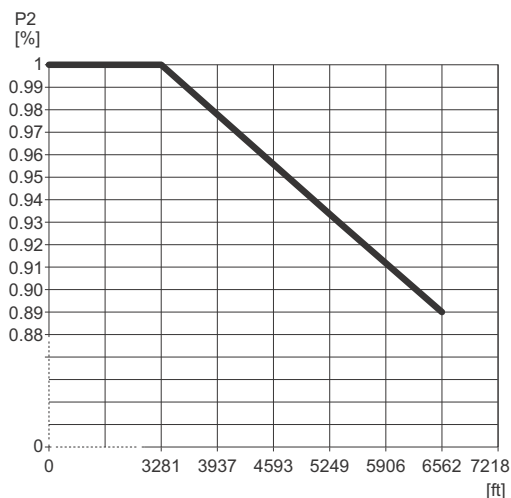

Fig. 24 Motor output power in relation to altitude

## 11.11 Humidity

Maximum air humidity: 95 %.

If the air humidity is constantly high and above 85 %, one of the drain holes in the drive-end flange must be open.

See section 6. *Receiving the product*.

## 11.12 Motor cooling

To ensure cooling of motor and electronics, observe the following:

- Position the motor in such a way that adequate cooling is ensured. See section 8.8 *Ensuring motor cooling*.
- The temperature of the cooling air must not exceed 122 °F (50 °C).
- Keep cooling fins and fan blades clean.

## 12. User interfaces

### WARNING

#### Hot surface



Death or serious personal injury

- Only touch the buttons on the display as the product may be very hot.

### WARNING

#### Electric shock



Death or serious personal injury

- If the control panel is cracked or perforated, replace it immediately. Contact the nearest Grundfos sales company.

You can make pump settings by means of the following user interfaces:

### Control panels

- Standard control panel.  
See section 13. *Standard control panel*.
- Advanced control panel.  
See section 14. *Advanced control panel*.

### Remote controls

- Grundfos GO Remote.  
See section 16. *Grundfos GO*.

If the power supply to the pump is switched off, the settings are stored.

TM06 9374 2117

### 13. Standard control panel

Pump variant	Fitted as standard	Option
TPE3, TPE3 D	-	•
TPE2, TPE2 D	-	•

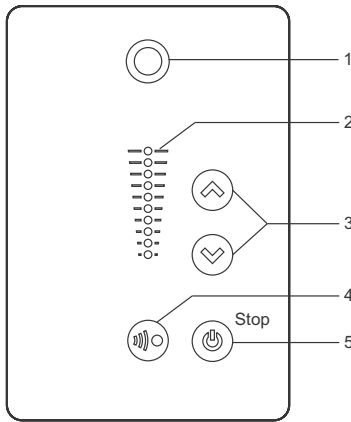

Fig. 25 Standard control panel

TM05 4848 3512

Pos.	Symbol	Description
1		Shows the operating status of the pump. See section 21. Grundfos Eye for further information.
2	-	Light fields for indication of setpoint.
3		Up and down. Changes the setpoint.
4		Allows radio communication with Grundfos GO and other products of the same type. When you try to establish radio communication between the pump and Grundfos GO or another pump, the green indicator light in Grundfos Eye on the pump flashes continuously. Press  on the pump control panel to allow radio communication with Grundfos GO and other products of the same type.
5		Makes the pump ready for operation as well as starts and stops the pump. <b>Start:</b> If you press the button when the pump is stopped, the pump only starts if no other functions with higher priority have been enabled. See section 20. Priority of settings . <b>Stop:</b> If you press the button when the pump is running, the pump always stops. The "Stop" text next to the button is on.

### 13.1 Setpoint setting

Set the desired setpoint of the pump by pressing or . The light fields on the control panel will indicate the setpoint set.

#### 13.1.1 Pump in differential-pressure control mode

The following example applies to a pump in an application where a pressure sensor gives a feedback to the pump. If you retrofit the sensor to the pump, set it up manually as the pump does not automatically register a connected sensor.

Figure 26 shows that the light fields 5 and 6 are activated, indicating a desired setpoint of 4.3 psi (3 m) with a sensor measuring range from 0 to 8.5 psi (0 to 6 m). The setting range is equal to the sensor measuring range.

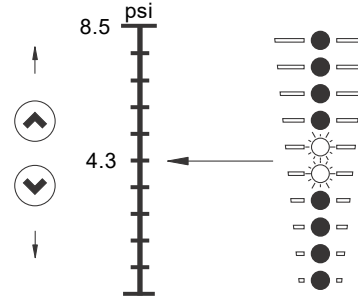

Fig. 26 Setpoint set to 4.3 psi (3 m), differential-pressure control

TM06 1116 1714

#### 13.1.2 Pump in constant-curve control mode

In constant-curve control mode, the pump performance will lie between the maximum and minimum curve of the pump. See fig. 27.

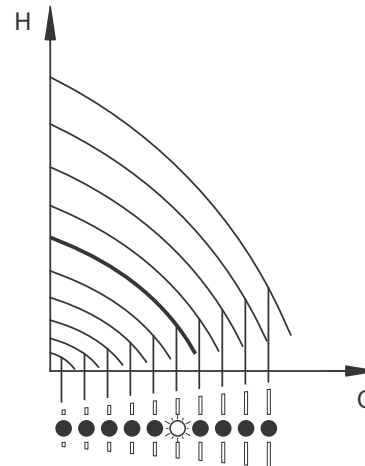





Fig. 27 Pump in constant-curve control mode

TM05 4895 2812

Setting to maximum curve:

- Press  continuously to change over to the maximum curve of the pump. The top light field flashes. When the top light field is on, press  for 3 seconds until the light field starts flashing.
- To change back, press  continuously until the desired setpoint is indicated.

#### Example

Pump set to maximum curve.

Figure 28 shows that the top light field is flashing, indicating maximum curve.

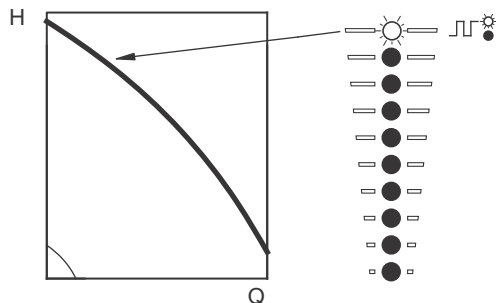





Fig. 28 Maximum curve duty

Setting to minimum curve:

- Press  continuously to change over to the minimum curve of the pump. The bottom light field flashes. When the bottom light field is on, press  for 3 seconds until the light field starts flashing.
- To change back, press  continuously until the desired setpoint is indicated.

#### Example

Pump set to minimum curve.

Figure 29 shows that the bottom light field is flashing, indicating minimum curve.

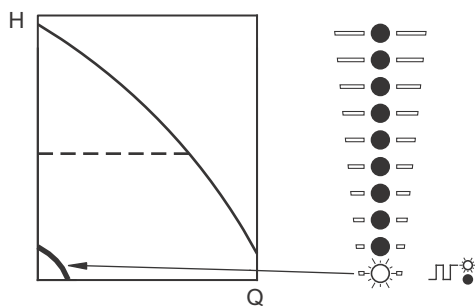







Fig. 29 Minimum curve duty



### 13.1.3 Start and stop of pump



If you have stopped the pump by pressing  and the "Stop" text on the control panel is on, you can only give it free to operation by pressing  again.

If you have stopped the pump by pressing , you can restart it by pressing  or by using Grundfos GO.





Start the pump by pressing  or by continuously pressing  until the desired setpoint is indicated.

Stop the pump by pressing . When the pump is stopped, the "Stop" text next to the button is on. You can also stop the pump by continuously pressing  until none of the light fields are on.

You can also stop the pump with the Grundfos GO or via a digital input set to "External stop". See section 20. *Priority of settings*.

### 13.1.4 Resetting of fault indications

Reset a fault indication in one of the following ways:

- Via the digital input if it has been set to Alarm resetting.
- Briefly press  or  on the pump. This does not change the setting of the pump. You cannot reset a fault indication by pressing  or  if the buttons have been locked.
- Switch off the power supply until the indicator lights are off.
- Switch the external start-stop input off and on.
- With Grundfos GO.

TM05 4896 2812

TM05 4897 2812

### 14. Advanced control panel

Pump variant	Fitted as standard	Option
TPE3, TPE3 D	•	-
TPE2, TPE2 D	•	-

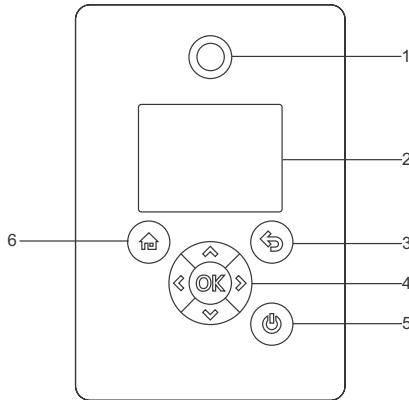
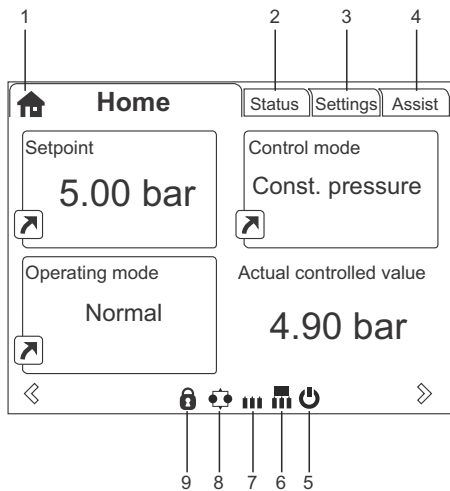

Fig. 30 Advanced control panel

TM05 4849 1013



Pos.	Symbol	Description
1		Grundfos Eye Shows the operating status of the pump. For further information, see section <a href="#">21. Grundfos Eye</a> .
2	-	Graphical color display.
3		Goes one step back.
		Navigates between main menus, displays and digits. When you change the menu, the display always shows the top display of the new menu.
		Navigates between submenus. Changes value settings. <b>Note:</b> If you have disabled the possibility to make settings with the Enable/disable settings function, then you can enable it again temporarily by pressing these buttons simultaneously for at least 5 seconds. See section <a href="#">17.35 "Buttons on product" (Enable/disable settings)</a> .
4		Saves changed values, resets alarms and expands the value field. Enables radio communication with Grundfos GO and other products of the same type. When you try to establish radio communication between the pump and Grundfos GO or another pump, the green indicator light in Grundfos Eye flashes. A note also appears in the pump display stating that a wireless device wants to connect to the pump. Press  on the pump control panel to allow radio communication with Grundfos GO and other products of the same type.
5		Makes the pump ready for operation, and starts and stops the pump. <b>Start:</b> If you press the button when the pump is stopped, the pump only starts if no other functions with higher priority have been enabled. See section <a href="#">20. Priority of settings</a> . <b>Stop:</b> If you press the button when the pump is running, the pump is always stopped. When you stop the pump via this button, the  icon appears in the bottom of the display.
6		Goes to the Home menu.

## 15. Home display



TM06 4516 2415

Fig. 31 Example of Home display

Pos.	Symbol	Description
1		Home This menu shows up to four user-defined parameters. You can select parameters shown as shortcut icon  , and when pressing  you go directly to the Settings display for the selected parameter.
2	-	Status This menu shows the status of the pump and system as well as warnings and alarms.
3	-	Settings This menu gives access to all setting parameters. You can make detailed settings of the pump in this menu. See section <a href="#">17. Description of functions</a> .
4	-	Assist This menu enables assisted pump setup, provides a short description of the control modes and offers fault advice. See section <a href="#">17.47 Assist</a> .
5		Indicates that the pump has been stopped via the  button.
6		Indicates that the pump is functioning as master pump in a multipump system.
7		Indicates that the pump is functioning as a slave pump in a multipump system.
8		Indicates that the pump is operating in a multipump system. See section <a href="#">17.51 "Multipump setup" (Setup of multi-pump system)</a> .
9		Indicates that the possibility to make settings has been disabled for protective reasons. See section <a href="#">17.35 "Buttons on product" (Enable/disable settings)</a> .

## 15.1 Start-up guide

The pump incorporates a startup guide which is started at the first startup. See section [17.44 Run start-up guide](#). After the startup guide, the main menus appear in the display.

## 15.2 Menu overview for advanced control panel

Home	TPE3, TPE3 D	TPE2, TPE2 D	Multipump system		
	•	•	•		
Status	TPE3, TPE3 D	TPE2, TPE2 D	Multipump system	Section	Page
Operating status	•	•	•		
Operating mode, from	•	•	•		
Power cons., sys.	•	•	•		
Pump performance	•	•	•		
Actual controlled value	•	•	•		
Max. curve and duty point	•	-	•		
Resulting setpoint	•	•	•		
Liquid temp.	•	-	•		
Speed	•	•	•		
Acc. flow and specific energy	•	•	•		
Power and energy consumption	•	•	•		
Measured values	•	•	•		
Analog input 1	•	•	•		
Analog input 2	•	•	•		
Analog input 3	•	•	•		
Pt100/1000 input 1	•	•	•		
Pt100/1000 input 2	•	•	•		
Analog output	•	•	•		
Warning and alarm	•	•	•		
Actual warning or alarm	•	•	•		
Warning log	•	•	•		
Alarm log	•	•	•		
"Heat energy monitor"	•	-	•	<a href="#">17.1 "Heat energy monitor"</a>	29
Heat power	•	-	•		
Heat energy	•	-	•		
Flow rate	•	-	•		
Volume	•	-	•		
Hours counter	•	-	•		
Temperature 1	•	-	•		
Temperature 2	•	-	•		
Differential temp.	•	-	•		
Operating log	•	•	•		
Operating hours	•	•	•		
Trend data	•	-	•		
Module type	•	•	•		
Date and time	•	•	•		
Product identification	•	•	•		
Motor bearing monitoring	•	•	•		
Multi-pump system	-	-	•		
System operating status	-	-	•		
System performance	-	-	•		
System input power and energy	-	-	•		
Pump 1, multi-pump system	-	-	•		
Pump 2, multi-pump system	-	-	•		
Pump 3, multi-pump system	-	-	•		
Pump 4, multi-pump system	-	-	•		

Settings	TPE3, TPE3 D	TPE2, TPE2 D	Multipump system	Section	Page
Warning and alarmSetpoint	•	•	•	<a href="#">17.2 Setpoint</a>	29
Operating mode	•	•	•	<a href="#">17.3 Operating mode</a>	29
Set manual speed	•	•	•	<a href="#">17.4 Set manual speed</a>	30
"Set user-defined speed"	•	•	•	<a href="#">17.5 "Set user-defined speed"</a>	30
Control mode	•	•	•	<a href="#">17.6 Control mode</a>	30
FLOW <sub>LIMIT</sub>	•	-	•	<a href="#">17.8 FLOW<sub>LIMIT</sub></a>	35
Automatic Night Setback	•	-	•	<a href="#">17.9 Automatic Night Setback</a>	36
Analog inputs	•	•	•		
Analog input 1, setup	•	•	•	<a href="#">17.10 Analog inputs</a>	36
Analog input 2, setup	•	•	•		
Analog input 3, setup	•	•	•		
Built-in Grundfos sensor	•	-	•	<a href="#">17.11 Built-in Grundfos sensor</a>	37
Pt100/1000 inputs	•	•	•		
Pt100/1000 input 1, setup	•	•	•	<a href="#">17.12 Pt100/1000 inputs</a>	38
Pt100/1000 input 2, setup	•	•	•		
Digital inputs	•	•	•		
Digital input 1, setup	•	•	•	<a href="#">17.13 Digital inputs</a>	38
Digital input 2, setup	•	•	•		
Digital inputs/outputs	•	•	•		
Digital input/output 3, setup	•	•	•	<a href="#">17.14 Digital inputs/outputs</a>	39
Digital input/output 4, setup	•	•	•		
Relay outputs	•	•	•		
Relay output 1	•	•	•	<a href="#">17.16 "Signal relay 1 and 2" (Relay outputs)</a>	40
Relay output 2	•	•	•		
Analog output	•	•	•		
Output signal	•	•	•	<a href="#">17.17 Analog output</a>	41
Function of analog output	•	•	•		
"Controller settings"	•	•	•	<a href="#">17.18 "Controller"("Controller settings")</a>	41
Operating range	•	•	•	<a href="#">17.19 Operating range</a>	43
Setpoint influence	•	•	•	<a href="#">17.20.1 Setpoint influence</a>	44
External setpoint function	•	•	•	<a href="#">17.20 External setpoint function</a>	43
"Predefined setpoints"	•	•	•	<a href="#">17.21 "Predefined setpoints"</a>	45
Temperature influence	•	-	•	<a href="#">17.22 "Temperature influence"</a>	45
Monitoring functions	•	•	•		
Motor bearing monitoring	•	•	•	<a href="#">17.28 Motor bearing monitoring</a>	47
Motor bearing maintenance	•	•	•	<a href="#">Bearings replaced (Motor bearing maintenance)</a>	48
Limit-exceeded function	•	•	•	<a href="#">17.23 Limit-exceeded function</a>	46
Alarm handling					
"Special functions"	•	•	•		
"Pulse flow meter setup"	•	•	•	<a href="#">17.24 "Pulse flowmeter setup"</a>	46
"Ramps"	•	•	•	<a href="#">17.25 "Ramps"</a>	47
"Standstill heating"	•	•	•	<a href="#">17.26 "Standstill heating"</a>	47
Communication	•	•	•		
Pump number	•	•	•	<a href="#">17.30 "Number" (Pump number)</a>	48
Enable/disable radio comm.	•	•	•	<a href="#">17.31 "Radio communication" (Enable/disable radio comm.)</a>	48
General settings	•	•	•		
Language	•	•	•	<a href="#">17.32 Language</a>	48
Set date and time	•	•	•	<a href="#">17.33 "Date and time" (Set date and time)</a>	48

<b>Settings</b>	<b>TPE3, TPE3 D</b>	<b>TPE2, TPE2 D</b>	<b>Multipump system</b>	<b>Section</b>	<b>Page</b>
Units	•	•	•	<a href="#">17.34 "Unit configuration" (Units)</a>	48
Enable/disable settings	•	•	•	<a href="#">17.35 "Buttons on product" (Enable/disable settings)</a>	48
Delete history	•	•	•	<a href="#">17.36 Delete history</a>	49
Define Home display	•	•	•	<a href="#">17.37 Define Home display</a>	49
Display settings	•	•	•	<a href="#">17.38 Display settings</a>	49
Store actual settings	•	•	•	<a href="#">17.39 "Store settings" (Store actual settings)</a>	49
Recall stored settings	•	•	•	<a href="#">17.40 "Recall settings" (Recall stored settings)</a>	49
Run start-up guide	•	•	•	<a href="#">17.44 Run start-up guide</a>	50

<b>Assist</b>	<b>TPE3, TPE3 D</b>	<b>TPE2, TPE2 D</b>	<b>Multipump system</b>	<b>Section</b>	<b>Page</b>
Assisted pump setup	•	•	•	<a href="#">17.48 Assisted pump setup</a>	50
Setup, analog input	•	•	•	<a href="#">17.49 Setup, analog input</a>	51
Setting of date and time	•	•	•	<a href="#">17.50 Setting of date and time</a>	51
Setup of multi-pump system	•	•	•	<a href="#">17.51 "Multipump setup" (Setup of multi-pump system)</a>	51
Description of control mode	•	•	•	<a href="#">17.52 Description of control mode</a>	54
Assisted fault advice	•	•	•	<a href="#">17.53 Assisted fault advice</a>	54

## 16. Grundfos GO

The pump is designed for wireless radio or infrared communication with Grundfos GO.

Grundfos GO enables setting of functions and gives access to status overviews, technical product information and actual operating parameters.

Grundfos GO offers the following mobile interface, MI.

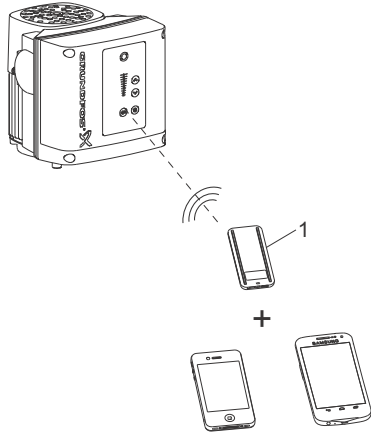



TM06 6256 02419

**Fig. 32** Grundfos GO communicating with the pump via radio or infrared connection, IR

Pos.	Description
1	Grundfos MI 301: Separate module enabling radio or infrared communication. You can use the module in conjunction with an Android or iOS-based smart device with Bluetooth connection.

### 16.1 Communication



When Grundfos GO communicates with the pump, the indicator light in the middle of the Grundfos Eye flashes green. See section [21. Grundfos Eye](#).

Furthermore, on pumps fitted with an advanced control panel a text appears in the display saying that a wireless device is trying to establish connection. Press  on the pump in order to establish connection with Grundfos GO or press  to reject connection.

Establish communication using one of these communication types:

- radio communication
- infrared communication.

#### 16.1.1 Radio communication

Radio communication can take place at distances up to 30 meters. The first time Grundfos GO communicates with the pump, you must enable communication by pressing  or  on the pump control panel. Later when communication takes place, the pump is recognized by Grundfos GO and you can select the pump from the "List" menu.

#### 16.1.2 Infrared communication

When communicating via infrared light, Grundfos GO must be pointed at the pump control panel.

## 16.2 Menu overview for Grundfos GO main menus

Dashboard	TPE3, TPE3 D	TPE2, TPE2 D	Multipump system		
	•	•	•		
Status	TPE3, TPE3 D	TPE2, TPE2 D	Multipump system	Section	Page
"System mode"	-	-	•*		
"Resulting setpoint"	•	•			
"Resulting system setpoint"	-	-	•*		
"Actual controlled value"	•	•	•*		
"Motor speed (rpm, %)"	•	•	-		
"Power consumption"	•	•	-		
"Power cons., sys."	-	-	•*		
"Energy consumption"	•	•			
"Energy cons., sys."	-	-	•*		
"Acc. flow, specific energy"	•	•	•*		
"Operating hours"	•	•			
"Operating hours, system"	-	-	•*		
"Liquid temperature"	•	-	-		
"Analog input 1"	•	•	-		
"Analog input 2"	•	•	-		
"Analog input 3"	•	•	-		
"Pt100/1000 input 1"	•	•	-		
"Pt100/1000 input 2"	•	•	-		
"Analog output"	•	•	-		
"Digital input 1"	•	•	-		
"Digital input 2"	•	•	-		
"Digital in/output 3"	•	•	-		
"Digital in/output 4"	•	•	-		
"Fitted modules"	•	•	-		
"Trend data"	•	-	-		
"Heat energy monitor"	•	-	-	<a href="#">17.1 "Heat energy monitor"</a>	29
"Pump 1"	-	-	•*		
"Pump 2"	-	-	•*		
"Pump 3"	-	-	•*		
"Pump 4"	-	-	•*		

\* Only available if Grundfos GO is connected to a multipump system.

Settings	TPE3, TPE3 D	TPE3, TPE3 D	Multipump system	Section	Page
"Setpoint"	•	•	•	<a href="#">17.2 Setpoint</a>	29
"Operating mode"	•	•	•	<a href="#">17.3 Operating mode</a>	29
"Set user-defined speed"	•	•	•	<a href="#">17.5 "Set user-defined speed"</a>	30
"Control mode"	•	•	•	<a href="#">17.6 Control mode</a>	30
"Proportional-pressure setup"	•	-	-	<a href="#">17.7 "Proportional-pressure setup"</a>	35
"Date and time"		•	•	<a href="#">17.33 "Date and time" (Set date and time)</a>	48
"Flow limit"	•	-	•	<a href="#">17.8 FLOW<sub>LIMIT</sub></a>	35
"Automatic Night Setback"	•	-	•	<a href="#">17.9 Automatic Night Setback</a>	36
"Temperature influence"	•	-	•	<a href="#">17.22 "Temperature influence"</a>	45
Buttons on product	•	•	•	<a href="#">17.35 "Buttons on product" (Enable/disable settings)</a>	48
"Controller"	•	•	•	<a href="#">17.18 "Controller" ("Controller settings")</a>	41

Settings	TPE3, TPE3 D	TPE3, TPE3 D	Multipump system	Section	Page
"Operating range"	•	•	•	<a href="#">17.19 Operating range</a>	43
"Ramps"	•	•		<a href="#">17.25 "Ramps"</a>	47
"Pump number"	•	•	-	<a href="#">17.30 "Number" (Pump number)</a>	48
"Radio communication"	•	•	-	<a href="#">17.31 "Radio communication" (Enable/disable radio comm.)</a>	48
"Analog input 1"	•	•	-	<a href="#">17.10 Analog inputs</a>	36
"Analog input 2"	•	•	-		
"Analog input 3"	•	•	-		
"Built-in Grundfos sensor"	•	-	•	<a href="#">17.11 Built-in Grundfos sensor</a>	37
"Pt100/1000 input 1"	•	•	-	<a href="#">17.12 Pt100/1000 inputs</a>	38
"Pt100/1000 input 2"	•	•	-		
"Digital input 1"	•	•	-	<a href="#">17.13 Digital inputs</a>	38
"Digital input 2"	•	•	-		
"Digital in/output 3"	•	•	-	<a href="#">17.14 Digital inputs/outputs</a>	39
"Digital in/output 4"	•	•	-		
"Predefined setpoint"	•	•	•	<a href="#">17.21 "Predefined setpoints"</a>	45
"Analog output"	•	•	-	<a href="#">17.17 Analog output</a>	41
"External setpoint funct."	•	•	-	<a href="#">17.20 External setpoint function</a>	43
"Signal relay 1"	•	•	-	<a href="#">17.16 "Signal relay 1 and 2" (Relay outputs)</a>	40
"Signal relay 2"	•	•	-		
"Limit 1 exceeded"	•	•	•	<a href="#">17.23 Limit-exceeded function</a>	46
"Limit 2 exceeded"	•	•	•		
"Alternating operation, time"	-	-	•*	<a href="#">17.51 "Multipump setup" (Setup of multi-pump system)</a>	51
"Time for pump changeover"	-	-	•*		
"Standstill heating"	•	•	-	<a href="#">17.26 "Standstill heating"</a>	47
"Motor bearing monitoring"	•	•	-	<a href="#">17.28 Motor bearing monitoring</a>	47
"Service"	•	•	-	<a href="#">17.29 "Service"</a>	48
"Store settings"	•	•	-	<a href="#">17.39 "Store settings" (Store actual settings)</a>	49
"Recall settings"	•	•	-	<a href="#">17.40 "Recall settings" (Recall stored settings)</a>	49
"Undo"	•	•	•	<a href="#">17.41 "Undo"</a>	49
"Pump name"	•	•	•	<a href="#">17.42 "Pump name"</a>	49
"Connection code"	•	•	•	<a href="#">17.43 "Connection code"</a>	49
"Unit configuration"	•	•	•	<a href="#">17.34 "Unit configuration" (Units)</a>	48

\* Only available if Grundfos GO is connected to a multipump system.

Alarms and warnings	TPE3, TPE3 D	TPE2, TPE2 D	Multipump system	Section	Page
"Alarm log"	•	•	•	<a href="#">17.45 Alarm log</a>	50
"Warning log"	•	•	•	<a href="#">17.46 Warning log</a>	50
"Reset alarm" button	•	•	•		

Assist	TPE3, TPE3 D	TPE2, TPE2 D	Multipump system	Section	Page
"Assisted pump setup"	•	•		<a href="#">17.48 Assisted pump setup</a>	50
"Assisted fault advice"	•	•	•	<a href="#">17.53 Assisted fault advice</a>	54
"Multipump setup"	•	•	•	<a href="#">17.51 "Multipump setup" (Setup of multi-pump system)</a>	51

## 17. Description of functions

### 17.1 "Heat energy monitor"

Pump variant	"Heat energy monitor"
TPE3, TPE3 D	•
TPE2, TPE2 D	-

The heat energy monitor is a monitoring function that calculates the heat energy consumption within a system. The built-in flow estimation needed for the calculation has an inaccuracy of  $\pm 10\%$  of the maximum flow in the area down to  $10\%$  flow and down to  $12.5\%$  of the maximum head. The calculations are based on water at a temperature of  $68\text{ °F}$  ( $20\text{ °C}$ ). Also, the temperature measurements needed for the calculation have some inaccuracy depending on the sensor type. Therefore, you cannot use the heat energy value for billing purposes. However, the value is perfect for optimization purposes in order to prevent excessive energy costs caused by system imbalances.

The heat energy monitor requires an additional temperature sensor installed in the flow pipe or return pipe depending on where the pump is installed.



Use the analog inputs and/or Pt100/1000 inputs for measuring the temperatures used for calculation by the heat energy monitor.

The used inputs must not be set to Not active and one of the measuring parameters must be set to Temperature 2.

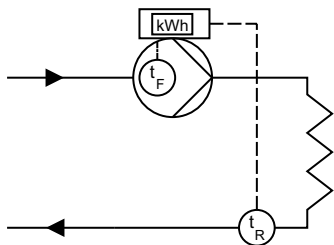

$t_F$ : Flow-pipe temperature

$t_R$ : Return-pipe temperature

**Fig. 33** Example: pump installed in the flow pipe and additional temperature sensor installed in the return pipe

### 17.2 Setpoint

Pump variant	Setpoint
TPE3, TPE3 D	•
TPE2, TPE2 D	•

You can set the setpoint for all control modes, except  $AUTO_{ADAPT}$  and  $FLOW_{ADAPT}$ , in this submenu when you have selected the desired control mode. See section [17.6 Control mode](#).

#### Factory setting

See section [35. Factory settings](#).

### 17.3 Operating mode

Pump variant	Operating mode
TPE3, TPE3 D	•
TPE2, TPE2 D	•

Possible operating modes:

- Normal  
The pump runs according to the selected control mode.
- Stop  
The pump stops.
- Min.  
Use the minimum-curve mode in periods in which a minimum flow is required.  
This operating mode is for instance suitable for manual night setback if you do not want to use the automatic night setback..
- Max.  
Use the maximum-curve mode in periods in which a maximum flow is required.  
This operating mode is for instance suitable for systems with hot-water priority.
- Manual  
The pump is operating at a manually set speed. In Manual the setpoint via bus is overruled. See section [17.5 "Set user-defined speed"](#).
- "User-defined speed"  
The motor is operating at a speed set by the user. See section [17.5 "Set user-defined speed"](#).

All operating modes are illustrated in the figure below.

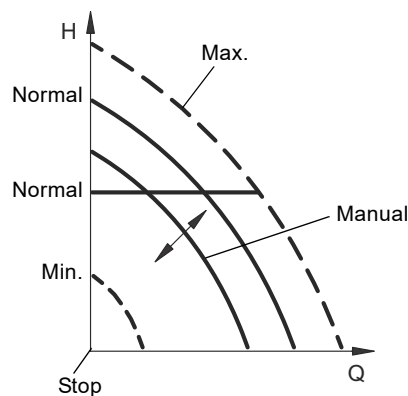

**Fig. 34** Operating modes

#### Factory setting

See section [35. Factory settings](#).

TM06 4024 1515

TM06 1182 1814

### 17.4 Set manual speed

Pump variant	Set manual speed
TPE3, TPE3 D	•
TPE2, TPE2 D	•

This menu is only available in the advanced control panel. With Grundfos GO, you set the speed via the Setpoint menu.

You can set the pump speed in % of the maximum speed. When you have set the operating mode to Manual, the pump starts running at the set speed. The speed can then be changed manually via Grundfos GO or via the advanced control panel.

#### Factory setting

See section 35. *Factory settings*.

### 17.5 "Set user-defined speed"

You can set the motor speed in % of the maximum speed. When you have set the operating mode to "User-defined speed", the motor runs at the set speed.

### 17.6 Control mode

Pump variant	"Control mode"
TPE3, TPE3 D	•
TPE2, TPE2 D	•

Possible control modes:

- $AUTO_{ADAPT}$
- $FLOW_{ADAPT}$
- Prop. press. (proportional pressure)
- Const. pressure (constant pressure)
- Const. temp. (constant temperature)
- Con. diff. press. (constant differential pressure)
- Con. diff. temp. (constant differential temperature)
- Const. flow rate (constant flow rate)
- Const. level (constant level)
- Const. other val. (constant other value)
- Const. curve (constant curve).



Set the operating mode to Normal before you enable a control mode.

You can change the setpoint for all control modes, except  $AUTO_{ADAPT}$  and  $FLOW_{ADAPT}$ , in the Setpoint submenu under Settings when you have selected the desired control mode.

#### Factory setting

See section 35. *Factory settings*.

### 17.6.1 $AUTO_{ADAPT}$

Pump variant	" $AUTO_{ADAPT}$ "
TPE3, TPE3 D	•
TPE2, TPE2 D	-

The  $AUTO_{ADAPT}$  control mode continuously adapts the pump performance according to the actual system characteristic.

Manual setting of the setpoint is not possible.

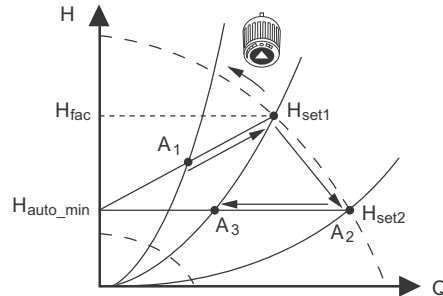

Fig. 35  $AUTO_{ADAPT}$

When the  $AUTO_{ADAPT}$  control mode has been enabled, the pump will start with the factory setting,  $H_{fac}$  is equal to  $H_{set1}$ , and then adjust its performance to  $A_1$ . See fig. 35.

When the pump registers a lower head on the maximum curve,  $A_2$ , the  $AUTO_{ADAPT}$  function automatically selects a correspondingly lower control curve,  $H_{set2}$ . If the valves in the system close, the pump will adjust its performance to  $A_3$ .

- $A_1$ : Original duty point.
- $A_2$ : Lower registered head on the maximum curve.
- $A_3$ : New duty point after  $AUTO_{ADAPT}$  control.
- $H_{set1}$ : Original setpoint setting.
- $H_{set2}$ : New setpoint after  $AUTO_{ADAPT}$  control.
- $H_{fac}$ : Factory setting.
- $H_{auto\_min}$ : A fixed value of 5 ft (1.5 m).

The  $AUTO_{ADAPT}$  control mode is a form of proportional-pressure control where the control curves have a fixed origin,  $H_{auto\_min}$ . The  $AUTO_{ADAPT}$  control is developed specifically for heating systems and we do not recommend that you use it for air-conditioning and cooling systems.

TM05 7910 1613

17.6.2 FLOW<sub>ADAPT</sub>

Pump variant	"FLOW <sub>ADAPT</sub> "
TPE3, TPE3 D	•
TPE2, TPE2 D	-

When you select FLOW<sub>ADAPT</sub>, the pump runs AUTO<sub>ADAPT</sub> and ensures that the flow never exceeds the entered FLOW<sub>LIMIT</sub> value.

The setting range for FLOW<sub>LIMIT</sub> is 25 to 90 %, of the maximum flow rate of the pump.

The factory setting of the FLOW<sub>LIMIT</sub> is the flow where the AUTO<sub>ADAPT</sub> factory setting meets the maximum curve. See fig. 36.

Do not set the FLOW<sub>LIMIT</sub> lower than the sized duty point.

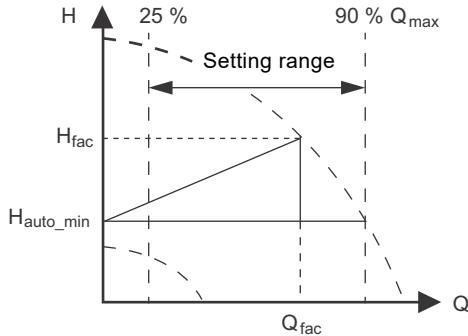

Fig. 36 FLOW<sub>ADAPT</sub>

TM05 7912 1613

17.6.3 "Proportional pressure"

Pump variant	"Proportional pressure"
TPE3,TPE3 D	•
TPE2,TPE2 D	-

The pump head is reduced at decreasing water demand and increased at rising water demand. See fig. 37.

This control mode is especially suitable in systems with relatively large pressure losses in the distribution pipes. The head of the pump increases proportionally to the flow in the system to compensate for the large pressure losses in the distribution pipes.

The setpoint can be set with an accuracy of 0.33 ft (0.1 m). The head against a closed valve is half the setpoint.

For more information about settings, see section 17.7 "Proportional-pressure setup".

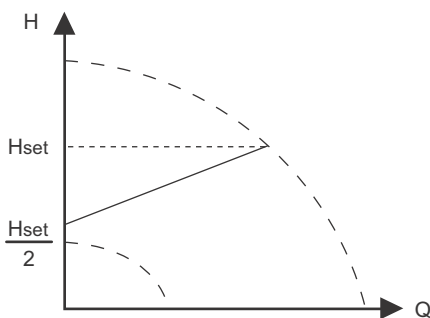

Fig. 37 "Proportional pressure"

TM05 7909 1613

Example

- Factory-fitted differential-pressure sensor.

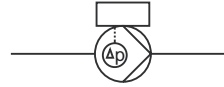

Fig. 38 "Proportional pressure"

Controller settings

For recommended controller settings, see section 17.18 "Controller"("Controller settings").

17.6.4 "Constant pressure"

Pump variant	Constant pressure
TPE3, TPE3 D	•
TPE2, TPE2 D	•

We recommend this control mode if the pump is to deliver a constant pressure, independently of the flow in the system. The pump maintains a constant pressure independently of the flow rate. See fig. 39.

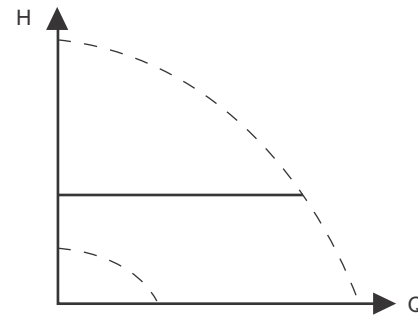

Fig. 39 Constant pressure

TM05 7901 1613

This control mode requires an external pressure sensor as shown in the examples below. You can set the pressure sensor in the Assist menu. See section 17.48 Assisted pump setup.

Examples

- One external pressure sensor.

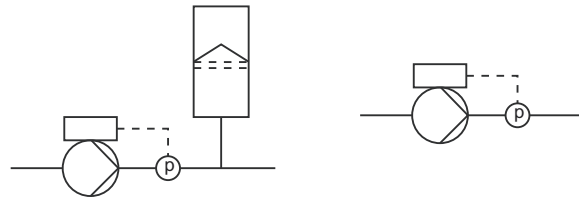

Fig. 40 "Constant pressure"

Controller settings

For recommended controller settings, see section 17.18 "Controller"("Controller settings").

### 17.6.5 "Constant temperature"

Pump variant	"Constant temperature"
TPE3, TPE3 D	•
TPE2, TPE2 D	•

This control mode ensures a constant temperature. Constant temperature is a comfort control mode that you can use in domestic hot-water systems to control the flow to maintain a constant temperature in the system. See fig. 41.

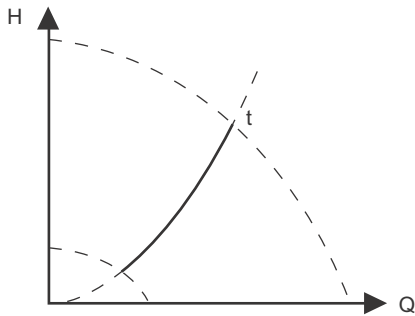

TM05 7900 1613

Fig. 41 Constant temperature

This control mode requires either an internal or external temperature sensor as shown in the examples below:

#### Examples

- Factory-fitted temperature sensor (only TPE3, TPE3 D).

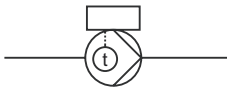

- One external temperature sensor.

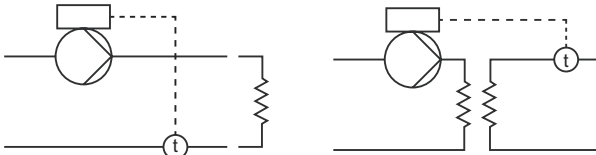

Fig. 42 Constant temperature

#### Controller settings

For recommended controller settings, see section 17.18 "Controller" ("Controller settings").

### 17.6.6 "Constant differential pressure"

Pump variant	"Constant differential pressure"
TPE3, TPE3 D	•
TPE2, TPE2 D	•

The pump maintains a constant differential pressure in the system and the pump performance is controlled according to this. See fig. 43.

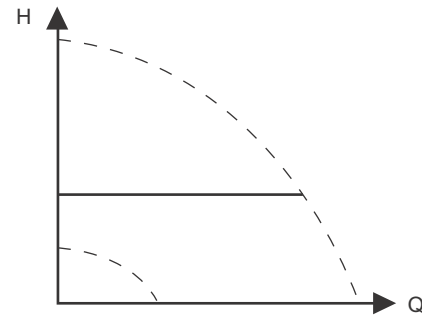

TM05 7901 1613

Fig. 43 "Constant differential pressure"

This control mode requires either an internal or external differential-pressure sensor or two external pressure sensors as shown in the examples below:

#### Examples

- Factory-fitted differential-pressure sensor. Only TPE3, TPE3 D.

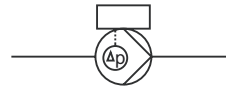

- One external differential-pressure sensor. The pump uses the input from the sensor to control the differential pressure. You can set sensor manually or by using the Assist menu. See section 17.48 Assisted pump setup.

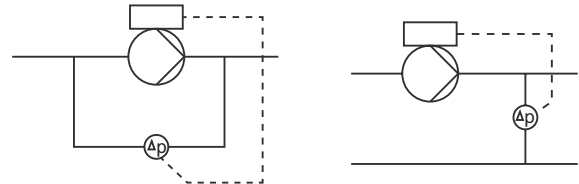

- Two external pressure sensors. Constant differential-pressure control is achievable with two individual pressure sensors. The pump uses the inputs from the two sensors and calculates the differential pressure. The sensors must have the same unit and must be set as feedback sensors. You can set the sensors manually, sensor by sensor, or by using the Assist menu. See section 17.48 Assisted pump setup.

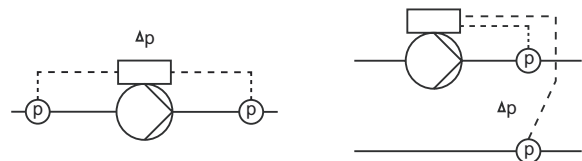

Fig. 44 "Constant differential pressure"

**Controller settings**

For recommended controller settings, see section [17.18 "Controller"\("Controller settings"\)](#).

**17.6.7 "Constant differential temperature"**

Pump variant	"Constant differential temperature"
TPE3,TPE3 D	•
TPE2,TPE2 D	•

The pump maintains a constant differential temperature in the system and the pump performance is controlled according to this. See fig. 45.

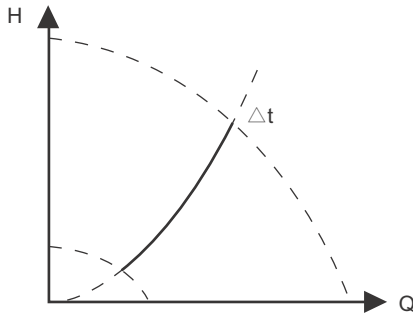

**Fig. 45** Constant differential temperature

This control mode requires either two temperature sensors or one external differential-temperature sensor. See the examples below.

The temperature sensors can either be analog sensors connected to two of the analog inputs or two Pt100/Pt1000 sensors connected to the Pt100/1000 inputs, if these are available on the specific pump.

Set the sensor in the Assist menu under Assisted pump setup. See section [17.48 Assisted pump setup](#).

**Examples**

- Factory-fitted temperature sensor and an external temperature sensor. Only TPE3, TPE3 D.

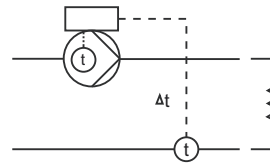

- Two external temperature sensors. Constant differential-temperature control is achievable with two temperature sensors. The pump uses the inputs from the two sensors and calculates the differential temperature. The sensors must have the same unit and must be set as feedback sensors. You can set the sensors manually, sensor by sensor, or by using the Assist menu. See section [17.48 Assisted pump setup](#).

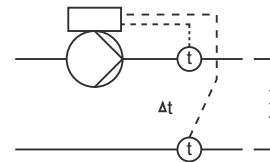

- One external differential-temperature sensor. The pump uses the input from the sensor to control the differential temperature. You can set the sensor manually or by using the Assist menu. See section [17.48 Assisted pump setup](#).

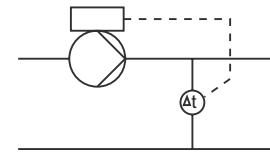

**Fig. 46** "Constant differential temperature"

**Controller settings**

For recommended controller settings, see section [17.18 "Controller"\("Controller settings"\)](#).

TM05 7954 1713

17.6.8 "Constant flow rate"

Pump variant	"Constant flow rate"
TPE3,TPE3 D	•
TPE2,TPE2 D	•

The pump maintains a constant flow in the system, independently of the head. See fig. 47.

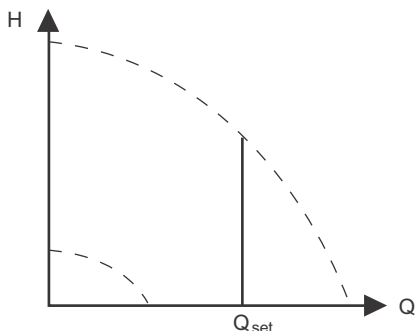

Fig. 47 "Constant flow rate"

This control mode requires an external flow sensor. See the example below.

Example

- One external flow sensor.

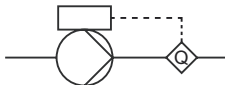

Fig. 48 "Constant flow rate"

Controller settings

For recommended controller settings, see section 17.18 "Controller" ("Controller settings").

17.6.9 "Constant level"

Pump variant	"Constant level"
TPE3,TPE3 D	•
TPE2,TPE2 D	•

The pump maintains a constant level, independently of the flow rate. See fig. 49.

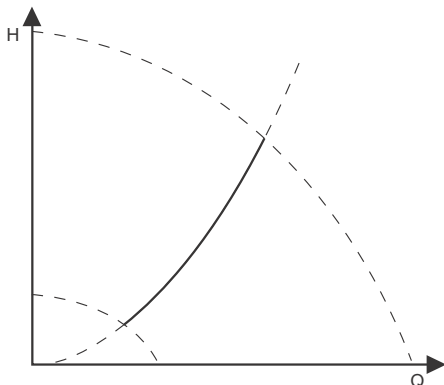

Fig. 49 "Constant level"

This control mode requires an external level sensor.

The pump can control the level in a tank in two ways:

- As an emptying function where the pump draws the liquid from the tank.
- As a filling function where the pump pumps the liquid into the tank.

See fig. 50.

The type of level control function depends on the setting of the built-in controller. See section 17.18 "Controller" ("Controller settings").

Examples

- One external level sensor.
  - emptying function.

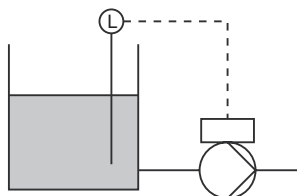

- One external level sensor.
  - filling function.

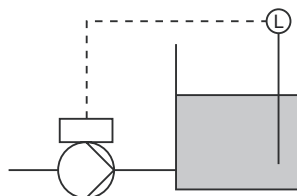

Fig. 50 "Constant level"

Controller settings

For recommended controller settings, see section 17.18 "Controller" ("Controller settings").

TM05 7955 1713

TM05 7941 1613

17.6.10 "Constant other value"

Pump variant	"Constant other value"
TPE3,TPE3 D	•
TPE2,TPE2 D	•

Any other value is kept constant.

Use this control mode if you want to control a value which is not available in the Control mode menu. Connect a sensor measuring the controlled value to one of the analog inputs of the pump. The controlled value will be shown in percentage of sensor range.

17.6.11 "Constant curve"

Pump variant	"Constant curve"
TPE3,TPE3 D	•
TPE2,TPE2 D	•

You can set the pump to operate according to a constant curve, like an uncontrolled pump. See fig. 51.

You can set the desired speed in % of maximum speed in the range from 13 to 100 %.

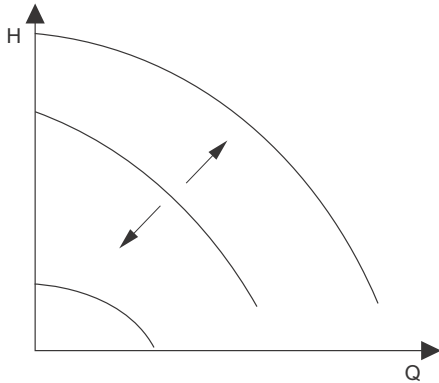

TM05 7957 1713

Fig. 51 "Constant curve"

Depending on the system characteristic and the duty point, the 100 % setting may be slightly smaller than the actual maximum curve of the pump even though the display shows 100 %. This is due to the power limitations built into the pump. The deviation varies according to pump type and pressure loss in the pipes.

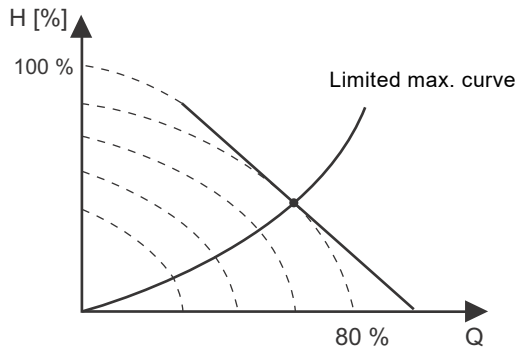

TM05 7913 1613

Fig. 52 Power limitations influencing the maximum curve

Controller settings

For recommended controller settings, see section 17.18 "Controller"("Controller settings").

17.7 "Proportional-pressure setup"

Pump variant	"Proportional-pressure setup"
TPE3, TPE3 D	•
TPE2, TPE2 D	-

"Control-curve function"

You can set the curve either to quadratic or linear.

"Zero-flow head"

You can set this value in % of the setpoint. With a setting of 100 %, the control mode is equal to constant differential pressure.

17.8 FLOW<sub>LIMIT</sub>

Pump variant	FLOW <sub>LIMIT</sub>
TPE3, TPE3 D	•
TPE2, TPE2 D	-

FLOW<sub>LIMIT</sub>

- Enable FLOW<sub>LIMIT</sub> function.
- Set FLOW<sub>LIMIT</sub>.

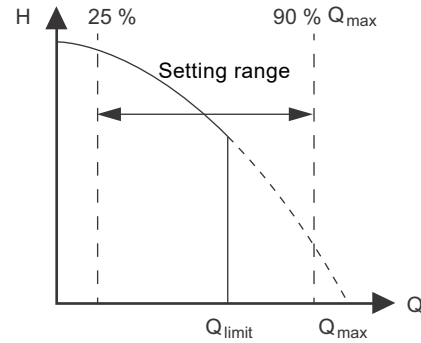

TM05 7908 1613

Fig. 53 FLOW<sub>LIMIT</sub>

You can combine the FLOW<sub>LIMIT</sub> function with the following control modes:

- Prop. press.
- Con. diff. press.
- Con. diff. temp.
- Const. temp.
- Const. curve.

A flow-limiting function ensures that the flow never exceeds the entered FLOW<sub>LIMIT</sub> value.

The setting range for FLOW<sub>LIMIT</sub> is 25 to 90 % of the Q<sub>max</sub> of the pump.

The factory setting of the FLOW<sub>LIMIT</sub> is the flow where the AUTO<sub>ADAPT</sub> factory setting meets the maximum curve. See fig. 36.

Factory setting

See section 35. [Factory settings](#)

### 17.9 Automatic Night Setback

Pump variant	Automatic Night Setback
TPE3, TPE3 D	•
TPE2, TPE2 D	-

Once you have enabled automatic night setback, the pump automatically changes between normal duty and night setback, duty at low performance.

Changeover between normal duty and night setback depends on the flow-pipe temperature.

The pump automatically changes over to night setback when the built-in sensor registers a flow-pipe temperature drop of more than 18 to 27 °F (10 to 15 °C) within approximately two hours. The temperature drop must be at least 1.8 °F/min (0.1 °C/min).

Changeover to normal duty takes place without a time lag when the temperature has increased by approximately 18 °F (10 °C).

You cannot enable automatic night1 setback when the pump is in constant-curve mode.

#### Factory setting

See section 35. [Factory settings](#).

### 17.10 Analog inputs

Pump variant	Analog inputs
TPE3, TPE3 D	•
TPE2, TPE2 D	•

Function	Terminal*
Analog input 1, setup	4
Analog input 2, setup	7
Analog input 3, setup	14

\* See section 9.5.1 [Connection terminals, advanced functional module, FM 300](#).

Set the analog input for a feedback sensor via the Assisted pump setup menu. See section 17.48 [Assisted pump setup](#).

If you want to set an analog input for other purposes, you can do this manually.

You can set the analogy inputs via the Setup, analog input menu. See section 17.49 [Setup, analog input](#).

If you perform the manual setting via Grundfos Go, you need to enter the menu for the analog input under the Settings menu.

#### Function

You can set the analog inputs to these functions:

- Not active
- Feedback sensor  
Sensor used for the selected control mode.
- Ext. setpoint infl.  
See section 17.20.1 [Setpoint influence](#)
- Other function.

### Measured parameter

Select one of the parameters, such as the parameter to be measured in the system by the sensor connected to the actual analog input. See fig. 54.

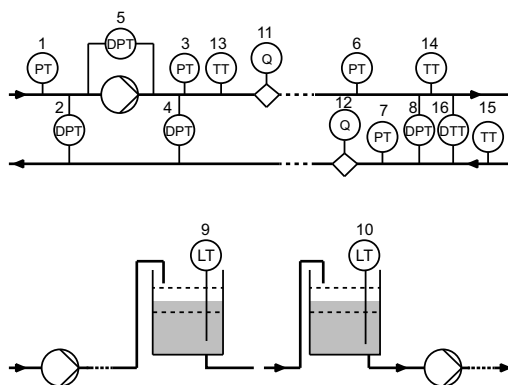

Fig. 54 Overview of sensor locations

Sensor function, measured parameter	Pos.
Inlet pressure	1
Diff. press., inlet	2
"Outlet pressure"	3
Diff. press., outlet	4
Diff. press, pump	5
Operating mode	6
Press. 2, external	7
Diff. press., ext.	8
Storage tank level	9
Feed tank level	10
Pump flow	11
Flow, external	12
Liquid temp. TPE3, TPE3 D: The temperature is measured by the built-in sensor.	13
Temperature 1	14
Temperature 2	15
Diff. temp., ext.	16
Ambient temp.	Not shown
Other parameter	Not shown

TM06 2328 3914

**Unit**

Available measuring units:

Parameter	Possible units
Pressure	ft, psi, bar, m, kPa
Level	m, ft, inch
Flow rate	m <sup>3</sup> /h, l/s, yd <sup>3</sup> /h, gpm,
Liquid temp.	°F, °C
Other parameter	%

**Electrical signal**

Select signal type:

- 0.5 - 3.5 V
- 0-5 V
- 0-10 V
- 0-20 mA
- 4-20 mA.

**Sensor range, minimum value**

Set the minimum value of the connected sensor.

**Sensor range, maximum value**

Set the maximum value of the connected sensor.

**Factory setting**

See section [35. Factory settings](#).

**Setting two sensors for differential measurement**

In order to measure the difference of a parameter between two points, set the corresponding sensors as follow:

Parameter	Analog input for sensor 1	Analog input for sensor 2
Pressure, option 1	Differential pressure, inlet	Differential pressure, outlet
Pressure, option 2	Pressure 1, external	Pressure 2, external
Flow	Pump flow	Flow, external
Temperature	Temperature 1	Temperature 2



If you want to use the control mode "constant differential pressure", you must choose the function Feedback sensor for the analog input of both sensors.

**17.11 Built-in Grundfos sensor**

Pump variant	Built-in Grundfos sensor
TPE3, TPE3 D	•
TPE2, TPE2 D	-

You can select the function of the built-in sensor in the Built-in Grundfos sensor menu.

Set the Built-in Grundfos sensor via the Assisted pump setup menu. See section [17.48 Assisted pump setup](#).

If you perform the setting manually in the advanced control panel, you must enter the Analog inputs menu under the Settings menu in order to access the Built-in Grundfos sensor menu.

If you perform the setting manually via Grundfos GO, you need to enter the menu for the Built-in Grundfos sensor under the Settings menu.

**Function**

You can set the built-in sensor to these functions:

- Grundfos diff. -pressure sensor
  - Not active
  - Feedback sensor
  - Setpoint influence
  - Other function.
- Grundfos temperature sensor
  - Not active
  - Feedback sensor
  - Setpoint influence
  - Other function

**Factory setting**

See section [35. Factory settings](#).

## 17.12 Pt100/1000 inputs

Pump variant	Pt100/1000 inputs
TPE3, TPE3 D	•
TPE2, TPE2 D	•

Function	Terminal
Pt100/1000 input 1, setup	17 and 18
Pt100/1000 input 2, setup	18 and 19

\* See section [9.5.1 Connection terminals, advanced functional module, FM 300](#).

For some pumps, the built-in temperature sensor is connected to Pt100/1000 input 1 (terminals 17 and 18).

Set the Pt100/1000 input for a feedback sensor via the Assisted pump setup menu. See section [17.48 Assisted pump setup](#).

If you want to set a Pt100/1000 input for other purposes, you can do this manually.

You can set the analog inputs via the Setup, analog input menu. See section [17.49 Setup, analog input](#).

If you perform the manual setting via Grundfos GO, you need to enter the menu for the Pt100/1000 input under the Settings menu.

### Function

You can set the Pt100/1000 inputs to these functions:

- Not active
- Feedback sensor
- Ext. setpoint infl.  
See section [17.20.1 Setpoint influence](#)
- Other function.

### Measured parameter

Select one of the parameters, such as the parameter to be measured in the system by the Pt100/1000 sensor connected to the actual Pt100/1000 input. See [fig. 55](#).

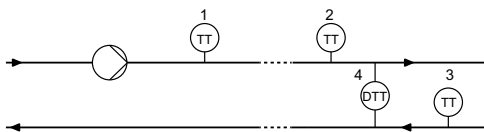

Fig. 55 Overview of Pt100/1000 sensor locations

Parameter	Pos.
Liquid temp.	1
Temperature 1	2
Temperature 2	3
Ambient temp.	Not shown

### Measuring range

-58 to +399 °F (-50 to +204 °C).

### Factory setting

See section [35. Factory settings](#).

## 17.13 Digital inputs

Pump variant	Digital inputs
TPE3, TPE3 D	•
TPE2, TPE2 D	•

Function	Terminal*
Digital input 1, setup	2 and 6
Digital input 2, setup	1 and 9

\* See section [9.5.1 Connection terminals, advanced functional module, FM 300](#). To set up a digital input, make the settings below.

### Function

Select one of these functions:

- Not active  
When set to Not active, the input has no function.
- External stop  
When the input is deactivated, open circuit, the pump stops.
- Min. (minimum speed)  
When the input is activated, the pump runs at the set minimum speed.
- Max. (maximum speed)  
When the input is activated, the pump runs at the set maximum speed.
- "User-defined speed"  
When the input is activated, the motor runs at a speed set by the user.
- External fault  
When the input is activated, a timer starts. If the input is activated for more than 5 seconds, the pump stops and a fault is indicated. This function depends on input from external equipment.
- Alarm resetting  
When the input is activated, a possible fault indication is reset.
- Dry running  
When this function has been selected, lack of inlet pressure or water shortage can be detected. When lack of inlet pressure or water shortage, dry running, is detected, the pump stops. The pump cannot restart as long as the input is activated. This requires the use of an accessory, such as these:
  - a pressure switch installed on the inlet side of the pump
  - a float switch installed on the inlet side of the pump.
- Accumulated flow  
When this function has been selected, the accumulated flow can be registered. This requires the use of a flowmeter which can give a feedback signal as a pulse per defined flow of water. See section [17.24 "Pulse flowmeter setup"](#).
- Predefined setpoint digit 1, applies only to digital input 2  
When digital inputs are set to a predefined setpoint, the pump operates according to a setpoint based on the combination of the activated digital inputs. See section [17.21 "Predefined setpoints"](#).
- Activate output  
When the input is activated, the related digital output is activated. See [17.14 Digital inputs/outputs](#). This is done without any changes to pump operation.

- Local motor stop  
When the input is activated, the given pump in a multipump system stops without affecting the performance of the other pumps in the system.

The priority of the selected functions in relation to each other appears from section 20. *Priority of settings*.

A stop command always has the highest priority.

**Activation delay**

Pump variant	Activation delay
TPE3, TPE3 D	-
TPE2, TPE2 D	•

Select the activation delay, T1.

It is the time between the digital signal and the activation of the selected function.

Range: 0 to 6000 seconds.

**Duration timer mode**

Select the mode. See fig. 56.

- Not active
- active with interrupt, mode A
- active without interrupt, mode B
- active with after-run, mode C.

Select the duration time, T2.

It is the time which, together with the mode, determines how long the selected function is active.

Range: 0 to 15,000 seconds.

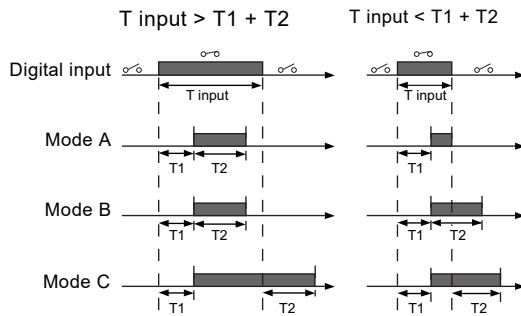

Fig. 56 Duration timer function of digital inputs

**Factory setting**

See section 35. *Factory settings*.

**17.14 Digital inputs/outputs**

Pump variant	Digital inputs/outputs
TPE3, TPE3 D	•
TPE2, TPE2 D	•

Function	Terminal*
Digital input/output 3, setup	10 and 16
Digital input/output 4, setup	11 and 18

\* See section 9.5.1 *Connection terminals, advanced functional module, FM 300*.

You can select if the interface must be used as input or output. The output is an open collector and you can connect it to for example an external relay or controller such as a PLC.

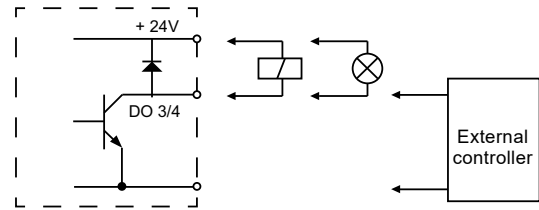

Fig. 57 Example of configurable digital inputs or outputs

To set up a digital input/output, make the settings below.

**Mode**

You can set the digital input or output 3 and 4 to act as digital input or digital output:

- Digital input
- Digital output.

**Function**

You can set the digital input or output 3 and 4 to the functions mentioned below:

You can set the signal outputs to the following:

- Operation
- Pump running
- Ready
- Alarm
- Warning.

**Possible functions, digital input or output 3**

Function if input	Function if output
• Not active	• Not active
• External stop	• Ready
• Min.	• Alarm
• Max.	• Operation
• External fault	• Pump running
• Alarm resetting	• Warning
• Dry running	• Limit 1 exceeded
• Accumulated flow*	• Limit 2 exceeded
• "Predefined setpoint 2"	• Digital input 1, state
• Activate output	• Digital input 2, state
• Local motor stop	• Digital input 3, state
	• Digital input 4, state

TM06 4463 2315

TM06 4949 3415

Possible functions, digital input/output 4

Function if input See details in section <a href="#">17.13 Digital inputs</a>	Function if output See details in section <a href="#">17.16 "Signal relay 1 and 2" (Relay outputs)</a>
<ul style="list-style-type: none"> <li>Not active</li> <li>External stop</li> <li>Min.</li> <li>Max.</li> <li>"User-defined speed"</li> <li>External fault</li> <li>Alarm resetting</li> <li>Dry running</li> <li>Accumulated flow*</li> <li>"Predefined setpoint digit 3"</li> <li>"Activate output"</li> <li>"Local motor stop"</li> </ul>	<ul style="list-style-type: none"> <li>Not active</li> <li>Ready</li> <li>Alarm</li> <li>Operation</li> <li>Pump running</li> <li>Warning</li> <li>Limit 1 exceeded</li> <li>Limit 2 exceeded</li> <li>Digital input 1, state</li> <li>Digital input 2, state</li> <li>Digital input 3, state</li> <li>Digital input 4, state</li> </ul>

17.15 Activation delay

Pump variant	Activation delay
TPE3, TPE3 D	-
TPE2, TPE2 D	•

Select the activation delay, T1.

It is the time between the digital signal and the activation of the selected function.

Range: 0 to 6000 seconds.

Duration timer mode

Select the mode. See fig. 58.

- Not active
- active with interrupt, mode A
- active without interrupt, mode B
- active with after-run, mode C.

Select the duration time, T2.

It is the time which, together with the mode, determines how long the selected function is active.

Range: 0 to 15,000 seconds.

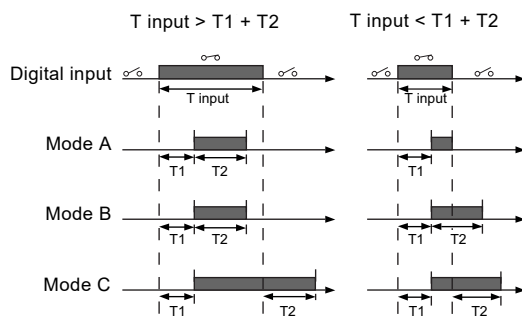

Fig. 58 Duration timer function of digital inputs

Factory setting

See section 35. [Factory settings](#).

17.16 "Signal relay 1 and 2" (Relay outputs)

Pump variant	"Signal relays 1 and 2"
TPE3, TPE3 D	•
TPE2, TPE2 D	•

Function	Terminal*
Relay output 1	NC, C1, NO
Relay output 2	NC, C2, NO

\* See section 9.5.1 [Connection terminals, advanced functional module, FM 300](#).

The pump incorporates two signal relays for potential-free signalling. For further information, see section 22. [Signal relays](#).

Function

You can configure the signal relays to be activated by one of the following incidents:

- Not active.
- Ready  
The pump can be running or is ready to run and no alarms are present.
- Alarm  
There is an active alarm and the pump is stopped.
- "Operating" (Operation)  
"Operating" equals "Running" but the pump is still in operation when it has been stopped due to a warning.
- "Running" (Pump running)
- Warning  
There is an active warning.
- Digital input 1, state  
Follows digital input 1. If digital input 1 is activated, output is also activated.
- Digital input 2, state  
Follows digital input 2. If digital input 2 is activated, output is also activated.
- Digital input 3, state  
Follows digital input 3. If digital input 3 is activated, output is also activated.
- Digital input 4, state  
Follows digital input 4. If digital input 4 is activated, output is also activated.
- Limit 1 exceeded  
When the Limit 1 exceeded function is activated, the signal relay is activated. See section 17.23 [Limit-exceeded function](#).
- Limit 2 exceeded  
When the Limit 2 exceeded function is activated, the signal relay is activated. See section 17.23 [Limit-exceeded function](#).
- Relubricate
- External fan control (Control of external fan)  
When you select "External fan control", the relay is activated if the internal temperature of the motor electronics reach a preset limit value.

Factory setting

See section 35. [Factory settings](#).

TM06 4949 3415

## 17.17 Analog output

Pump variant	Analog output
TPE3, TPE3 D	•
TPE2, TPE2 D	•

Function	Terminal*
Analog output	12

\* See section [9.5.1 Connection terminals, advanced functional module, FM 300](#).

The analog output enables the transfer of certain operating data to external control systems.

To set up the analog output, make the settings below.

### Output signal

- 0-10 V
- 0-20 mA
- 4-20 mA.

### Function of analog output

- Actual speed

Signal range [V, mA]	Actual speed [%]		
	0	100	200
0-10 V	0 V	5 V	10 V
0-20 mA	0 mA	10 mA	20 mA
4-20 mA	4 mA	12 mA	20 mA

The reading is a percentage of nominal speed.

- Actual value

Signal range [V, mA]	Actual value	
	Sensor <sub>min</sub>	Sensor <sub>max</sub>
0-10 V	0 V	10 V
0-20 mA	0 mA	20 mA
4-20 mA	4 mA	20 mA

The reading is a percentage of the range between sensor<sub>min</sub> and sensor<sub>max</sub>.

- Resulting setpoint

Signal range [V, mA]	Resulting setpoint [%]	
	0	100
0-10 V	0 V	10 V
0-20 mA	0 mA	20 mA
4-20 mA	4 mA	20 mA

The reading is a percentage of the external setpoint range.

- Motor load

Signal range [V, mA]	Motor load [%]	
	0	100
0-10 V	0 V	10 V
0-20 mA	0 mA	20 mA
4-20 mA	4 mA	20 mA

The reading is a percentage of the range between 0 and 200 % of the maximum permissible load at the actual speed.

- Motor current

Signal range [V, mA]	Motor current [%]		
	0	100	200
0-10 V	0 V	5 V	10 V
0-20 mA	0 mA	10 mA	20 mA
4-20 mA	4 mA	12 mA	20 mA

The reading is a percentage of the range between 0 and 200 % of the rated current ( $I_N$ ).

- Limit 1 exceeded and Limit 2 exceeded

Signal range [V, mA]	Limit-exceeded function	
	Output not active	Output active
0-10 V	0 V	10 V
0-20 mA	0 mA	20 mA
4-20 mA	4 mA	20 mA

The Limit-exceeded function is typically used for monitoring of secondary parameters in the system. If the limit is exceeded, an output, warning or alarm is activated.

- Flow rate

Signal range [V, mA]	Flow rate [%]		
	0	100	200
0-10 V	0 V	5 V	10 V
0-20 mA	0 mA	10 mA	20 mA
4-20 mA	4 mA	12 mA	20 mA

The reading is a percentage of the range between 0 and 200 % of the nominal flow.

### Factory setting

See section [35. Factory settings](#).

## 17.18 "Controller" ("Controller settings")

Pump variant	"Controller" ("Controller settings")
TPE3,TPE3 D	•
TPE2,TPE2 D	•

The pumps have a factory default setting of gain,  $K_p$  and integral time,  $T_i$ .

However, if the factory setting is not the optimum setting, you can change the gain and the integral time:

- Set the gain within the range from 0.1 to 20.
- Set the integral time within the range from 0.1 to 3600 s.  
If you select 3600 seconds, the controller functions as a P controller.

Furthermore, you can set the controller to inverse control.

This means that if the setpoint is increased, the speed is reduced. In the case of inverse control, set the gain within the range from -0.1 to -20.

**Guidelines for setting of PI controller**

The tables below show the recommended controller settings:

"Differential-pressure control"	$K_p$	$T_i$
	0.5	0.5
	0.5	L1 < 16.4 ft (5 m): 0.5 L1 > 16.4 ft (5 m): 3 L1 > 32.8 ft (10 m): 5

L1 = Distance ft (m) between pump and sensor.

"Temperature control"	$K_p$		$T_i$
	Heating system <sup>1)</sup>	Cooling system <sup>2)</sup>	
	0.5	-0.5	10 + 5L2
	0.5	-0.5	30 + 5L2

1) In heating systems, an increase in pump performance results in a rise in temperature at the sensor.

2) In cooling systems, an increase in pump performance results in a drop in temperature at the sensor.

L2: distance in ft (m) between heat exchanger and sensor.

"Differential-temperature control"	$K_p$	$T_i$
	-0.5	10 + 5L2

L2: distance in ft (m) between heat exchanger and sensor.

"Flow control"	$K_p$	$T_i$
	0.5	0.5
"Constant-pressure control"	$K_p$	$T_i$
	0.5	0.5
	0.1	0.5
"Level control"	$K_p$	$T_i$
	-2.5	100
	2.5	100

**Rules of thumb**

If the controller is too slow-reacting, increase the gain.

If the controller is hunting or unstable, dampen the system by reducing the gain or increasing the integral time.

**Factory setting**

See section 35. [Factory settings](#).

### 17.19 Operating range

Pump variant	Operating range
TPE3, TPE3 D	•
TPE2, TPE2 D	•

Set the operating range as follows:

- Set the minimum speed within the range from fixed minimum speed to user-set maximum speed.
- Set the maximum speed within the range from user-set minimum speed to fixed maximum speed.

The range between the user-set minimum and maximum speeds is the operating range. See fig. 59.

Speeds below 25 % may result in noise from the shaft seal.

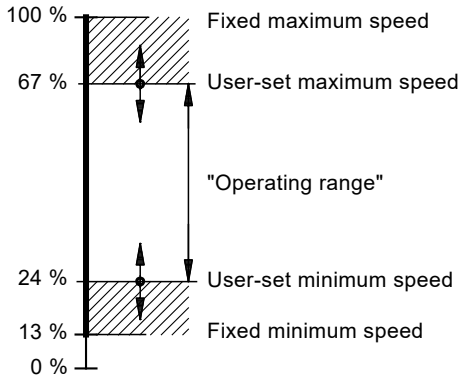

Fig. 59 Example of minimum and maximum settings

#### Factory setting

See section 35. [Factory settings](#).

### 17.20 External setpoint function

Pump variant	External setpoint function
TPE3, TPE3 D	•
TPE2, TPE2 D	•

You can influence the setpoint by an external signal, either via one of the analog inputs or, if an advanced functional module is fitted, via one of the Pt100/1000 inputs.



Before you can enable the External setpoint function, you must set one of the analog inputs or Pt100/1000 inputs to Setpoint influence.

See section 17.10 [Analog inputs](#) and 17.12 [Pt100/1000 inputs](#).

If more than one input has been set to Setpoint influence, the function selects the analog input with the lowest number, for example Setting of pump, and ignores the other inputs, for example Analog input 3 or "Pt100/1000 input 1".

### Example with constant pressure with linear influence

Actual setpoint: actual input signal x (setpoint - sensor min.) + sensor min.

At a lower sensor value of 0 bar, a setpoint of 2 bar and an external setpoint of 60 %, the actual setpoint is  $0.06 \times (2 - 0) + 0 = 1.2$  bar.

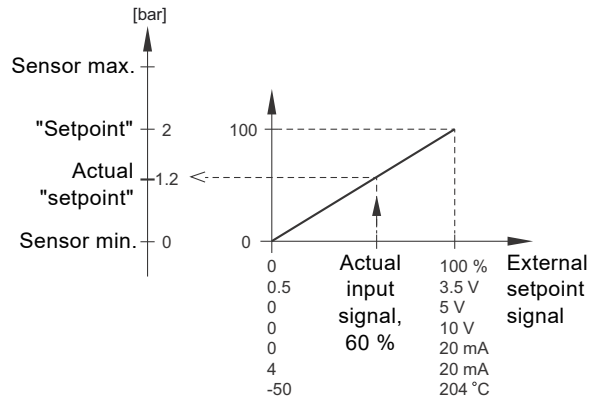

Fig. 60 Example of setpoint influence with sensor feedback

### Example with constant curve with linear influence

Actual setpoint: actual input signal x (setpoint - user-set minimum speed) + user-set minimum speed.

At a user-set minimum speed of 25 %, a setpoint of 85 % and an external setpoint of 60 %, the actual setpoint is  $0.60 \times (85 - 25) + 25 = 61$  %. See fig. 61.

In some cases, the maximum curve is limited to a lower speed. See fig. 52.

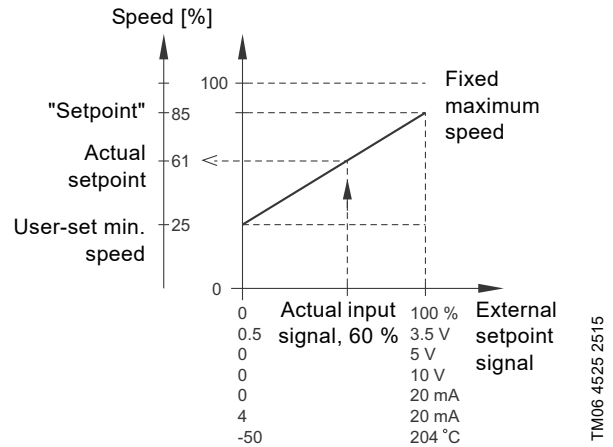

Fig. 61 Example of setpoint influence with constant curve

#### Factory setting

See section 35. [Factory settings](#).

TM06 4165 1615

TM00 6785 5095

TM06 4525 2515

17.20.1 Setpoint influence

Pump variant	Setpoint influence
TPE3, TPE3 D	•
TPE2, TPE2 D	•

The table below gives an overview of the types of setpoint influence and the availability depending on pump type.

"Setpoint influence"	Pump type	
	TPE3, TPE3 D	TPE2, TPE2 D
Not active	•	•
Linear function	•	•
Linear with Stop	•	•
Influence table	•	•

You can select these functions:

- Not active  
when set to Not active, the setpoint is not influenced from any external function.
- Linear function  
The setpoint is influenced linearly from 0 to 100 %. See fig. 62.

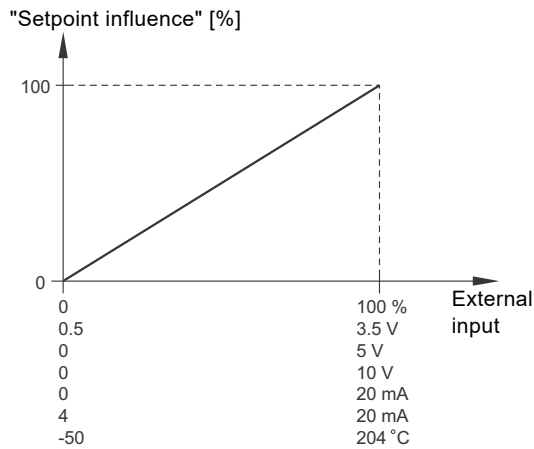

Fig. 62 Linear function

- Linear with Stop
  - In the input signal range from 20 to 100 %, the setpoint is influenced linearly.
  - If the input signal is below 10 %, the pump changes to operating mode Stop.
  - If the input signal is above 15 %, the operating mode is changed back to Normal. See fig. 63.

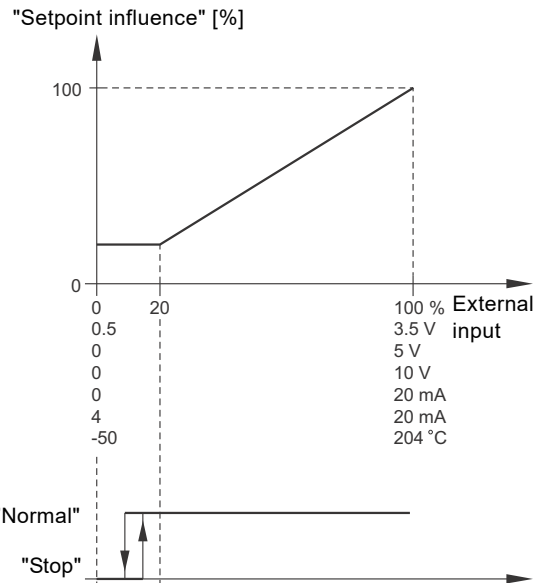

Fig. 63 Linear with Stop

- Influence table  
The setpoint is influenced by a curve made out of two to eight points. There will be a straight line between the points and a horizontal line before the first point and after the last point.

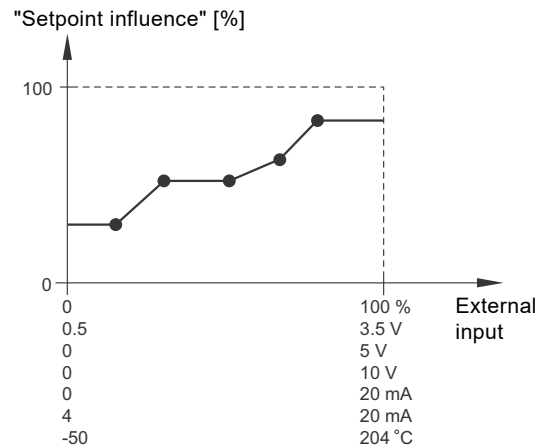

Fig. 64 Influence table, example with five points

## 17.21 "Predefined setpoints"

Pump variant	"Predefined setpoints"
TPE3,TPE3 D	•
TPE2,TPE2 D	•

You can set and activate seven predefined setpoints by combining the input signals to digital inputs 2, 3 and 4 as shown in the table below.

Set the digital inputs 2, 3 and 4 to "Predefined setpoints" if all seven predefined setpoints are to be used. You can also set one or two of the digital inputs to "Predefined setpoints" but this will limit the number of predefined setpoints available.

Digital inputs			Setpoint
2	3	4	
0	0	0	Normal setpoint or stop
1	0	0	Predefined setpoint 1
0	1	0	Predefined setpoint 2
1	1	0	Predefined setpoint 3
0	0	1	Predefined setpoint 4
1	0	1	Predefined setpoint 5
0	1	1	Predefined setpoint 6
1	1	1	Predefined setpoint 7

0: Open contact

1: Closed contact

### Example

Figure 65 shows how you can use the digital inputs to set seven predefined setpoints. Digital input 2 is open and digital inputs 3 and 4 are closed. If you compare with the table above, you can see that "Predefined setpoint 6" is activated.

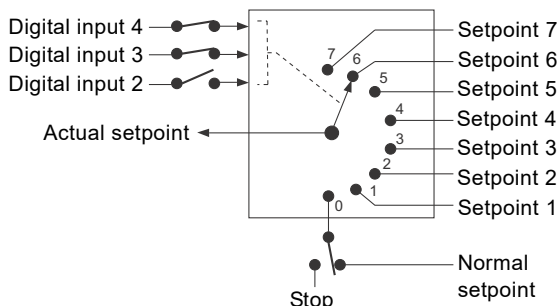

**Fig. 65** Principle sketch showing how predefined setpoints function

If all digital inputs are open, the pump either stops or runs at the normal setpoint. Set the desired action with Grundfos GO or with the advanced control panel.

### Factory setting

See section 35. [Factory settings](#).

## 17.22 "Temperature influence"

Pump variant	"Temperature influence"
TPE3,TPE3 D	•
TPE2,TPE2 D	-

When the function is enabled in proportional- or constant-pressure control mode, the setpoint for head is reduced according to the liquid temperature.

You can set the temperature influence to function at liquid temperatures below +176 °F or +122 °F (80 °C or 50 °C). These temperature limits are called  $T_{max}$ . The setpoint is reduced in relation to the head set which is equal to 100 % according to the characteristics below.

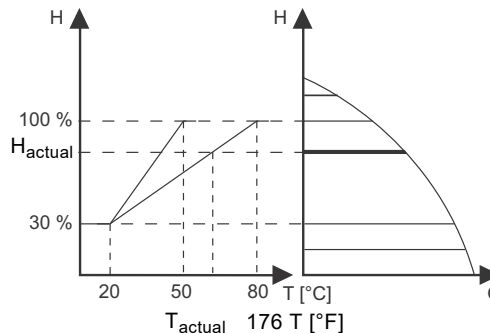

**Fig. 66** "Temperature influence"

In the above example,  $T_{max}$ , which is equal to +176 °F (+80 °C), has been selected.

The actual liquid temperature,  $T_{actual}$ , causes the setpoint for head to be reduced from 100 % to  $H_{actual}$ .

The temperature influence function requires the following:

- proportional-pressure or constant-pressure control mode
- pump installed in flow pipe
- system with flow-pipe temperature control.

Temperature influence is suitable for the following systems:

- Systems with variable flows, for example two-pipe heating systems, in which the enabling of the temperature influence function ensures a further reduction of the pump performance in periods with small heating demands and consequently a reduced flow-pipe temperature.
- Systems with almost constant flows, for example one-pipe heating systems and underfloor heating systems, in which variable heating demands cannot be registered as changes in the head as is the case with two-pipe heating systems. In such systems, you can only adjust the pump performance by enabling the temperature influence function.

### Selecting the maximum temperature

In systems with a dimensioned flow-pipe temperature of:

- up to and including +131 °F (+55 °C), select  $T_{max}$  equal to 50 °C,
- above +131 °F (+55 °C), select  $T_{max}$  equal to +176 °F (80 °C).

You cannot use the temperature influence function in air-conditioning and cooling systems.

### Factory setting

See section 35. [Factory settings](#).

TM05 7911 1613

TM06 4269 1815

### 17.23 Limit-exceeded function

Pump variant	Limit-exceeded function
TPE3,TPE3 D	•
TPE2,TPE2 D	•

This function can monitor a measured parameter or one of the internal values such as speed, motor load or motor current. If a set limit is reached, a selected action can take place. You can set two limit-exceeded functions meaning that you can monitor two parameters or two limits of the same parameter simultaneously.

The function requires setting of the following:

#### Measured

Here you set the measured parameter to be monitored.

#### "Limit"

Here you set the limit which activates the function.

#### "Hysteresis band"

Here you set the hysteresis band.

#### "Limit exceeded when"

Here you can set if you want the function to be activated when the selected parameter exceeds or drops below the set limit.

- "Above limit"  
The function is activated if the measured parameter exceeds the set limit.
- "Below limit"  
The function is activated if the measured parameter drops below the set limit.

#### Action

If the value exceeds a limit, you can define an action. You can select the following actions:

- "No action"  
The pump remains in its current state. Use this setting if you only want to have a relay output when the limit is reached. See section [17.16 "Signal relay 1 and 2" \(Relay outputs\)](#).
- "Warning/alarm"  
There is a warning.
- Stop  
The pump stops.
- Min.  
The pump reduces speed to minimum.
- Max.  
The pump increases speed to maximum.
- "User-defined speed"  
The pumps run at a speed set by the user.
- Alarm + Stop  
An alarm is given and the pump stops.
- Alarm + Min.  
An alarm is given and the pump decreases speed to minimum.
- Alarm + Max.  
An alarm is given and the pump increases speed to maximum.
- Alarm + User-defined speed  
An alarm is given and the pump runs at a speed set by the user.

#### "Detection delay"

You can set a detection delay which ensures that the monitored parameter stays above or below a set limit in a set time before the function is activated.

#### "Resetting delay"

The resetting delay is the time from which the measured parameter differs from the set limit including the set hysteresis band and until the function is reset.

### Example

The function is to monitor the outlet pressure of a pump. If the pressure is below 72.5 psi (5 bar) for more than 5 seconds, a warning must be given. If the outlet pressure is above 7 bar for more than 8 seconds, you must reset the warning.

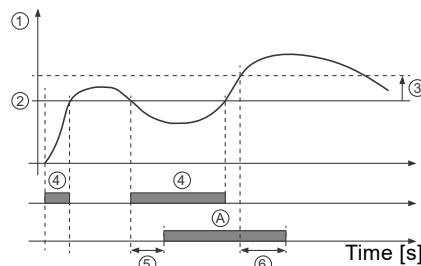

Fig. 67 "Limit exceeded" (example)

Pos.	Setting parameter	Setting
1	Measured	Outlet pressure
2	"Limit"	72.5 psi (5 bar)
3	"Hysteresis band"	29 psi (2 bar)
4	"Limit exceeded when"	Below limit
5	"Detection delay"	5 seconds
6	"Resetting delay"	8 seconds
A	Limit-exceeded function active	-
-	Action	Warning

#### Factory setting

See section [35. Factory settings](#).

### 17.24 "Pulse flowmeter setup"

Pump variant	"Pulse flowmeter setup"
TPE3,TPE3 D	•
TPE2,TPE2 D	•

You can connect an external pulse flowmeter to one of the digital inputs in order to register the actual and accumulated flows. Based on this, you can also calculate the specific energy.

To enable a pulse flowmeter, set one of the digital-inputs to Accumulated flow and set the pumped volume per pulse. See section [17.13 Digital inputs](#).

#### Factory setting

See section [35. Factory settings](#).

## 17.25 "Ramps"

Pump variant	"Ramps"
TPE3 (D)	•
TPE2 (D)	•

The ramps determine how quickly the motor can accelerate and decelerate, during start/stop or setpoint changes.

You can set the following:

- acceleration time, 0.1 to 300 seconds
- deceleration time, 0.1 to 300 seconds.

The times apply to the acceleration from 0 rpm to fixed maximum speed and the deceleration from fixed maximum speed to 0 rpm.

At short deceleration times, the deceleration of the motor may depend on load and inertia as there is no possibility of actively braking the motor.

If the power supply is switched off, the deceleration of the motor only depends on load and inertia.

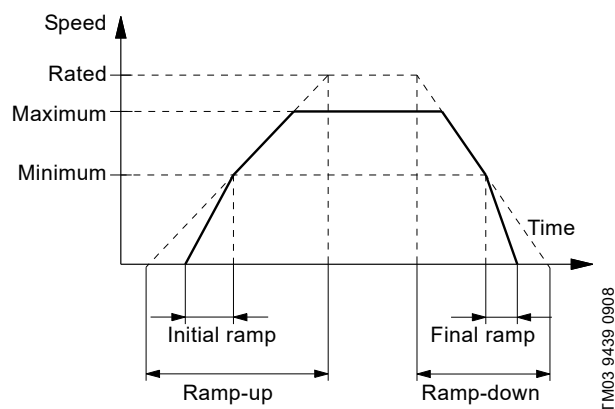

Fig. 68 Ramp-up and ramp-down

### Factory setting

See section [35. Factory settings](#).

## 17.26 "Standstill heating"

Pump variant	"Standstill heating"
TPE3, TPE3 D	•
TPE2, TPE2 D	•

You can use this function to avoid condensation in humid environments. When you set the function to Active and the pump is in operating mode Stop, a low AC voltage will be applied to the motor windings. The voltage is not high enough to make the motor rotate but ensures that sufficient heat is generated to avoid condensation in the motor including the electronic parts in the drive.



Remember to remove the drain plugs and fit a cover over the motor.

For further information, see section [8.9 Outdoor installation](#).

### Factory setting

See section [35. Factory settings](#).

## 17.27 Alarm handling

Pump variant	Alarm handling
TPE3, TPE3 D	•
TPE2, TPE2 D	•

The alarm handling determines how the pump must react in case of a sensor failure.

Inputs	Alarm handling
"Analog input 1"	<b>"Warning"</b> : no change of operation.
"Analog input 2"	Stop: an alarm is given, and the pump stops.
"Analog input 3"	Min.: an alarm is given, and the pump reduces speed to minimum.
"Built-in Grundfos sensor"	Max.: an alarm is given, and the pump increases speed to maximum.
"Liqtec input"	<b>"User-defined speed"</b> : an alarm is given, and the pump runs at a speed set by the user.

## 17.28 Motor bearing monitoring

Pump variant	Motor bearing monitoring
TPE3, TPE3 D	•
TPE2, TPE2 D	•

You can set the motor bearing monitoring function to these values:

- Active
- Not active

When the function is set to Active, a counter in the controller will start counting the mileage of the bearings.

The counter continues counting even if the function is changed to Not active, but a warning is not given when it is time for replacement.

When the function is changed to "Active" again, the accumulated mileage is again used to calculate the replacement time.

### Factory setting

See section [35. Factory settings](#).

### 17.29 "Service"

Pump variant	"Service"
TPE3, TPE3 D	•
TPE2, TPE2 D	•

#### "Time until next service" (Motor bearing service)

This display shows when to replace the motor bearings. The controller monitors the operating pattern of the motor and calculates the period between bearing replacements.

Displayable values:

- "in 2 years"
- "in 1 year"
- "in 6 months"
- "in 3 months"
- "in 1 month"
- "in 1 week"
- "Now".

#### "Bearing replacements"

Indicates the number of bearing replacements that have been done during the lifetime of the motor.

#### Bearings replaced (Motor bearing maintenance)

When the bearing monitoring function is active, the controller gives a warning when the motor bearings are to be replaced.

When you have replaced the motor bearings, confirm this action by pressing [Bearings replaced].

### 17.30 "Number" (Pump number)

Pump variant	"Number" (Pump number)
TPE3, TPE3 D	•
TPE2, TPE2 D	•

You can allocate a unique number to the pump. This makes it possible to distinguish between pumps in connection with bus communication.

#### Factory setting

See section [35. Factory settings](#).

### 17.31 "Radio communication" (Enable/disable radio comm.)

Pump variant	"Radio communication" (Enable/disable radio comm.)
TPE3, TPE3 D	•
TPE2, TPE2 D	•

You can set the radio communication to either enabled or disabled. You can use this function in areas where radio communication is not allowed.

IR communication remains active.

#### Factory setting

See section [35. Factory settings](#).

### 17.32 Language

Pump variant	Language
TPE3, TPE3 D	•
TPE2, TPE2 D	•

This menu is only available in the advanced control panel.

In this menu you can select the desired language. A number of languages are available.

### 17.33 "Date and time" (Set date and time)

Pump variant	"Date and time" (Set date and time)
TPE3, TPE3 D	•
TPE2, TPE2 D	•

You can set date and time as well as how they are to be shown in the display:

- Select date format:  
YYYY-MM-DD  
DD-MM-YYYY  
MM-DD-YYYY.
- Select time format:  
HH:MM 24-hour clock  
HH:MM am/pm 12-hour clock.
- Set date
- Set time.

### 17.34 "Unit configuration" (Units)

Pump variant	"Unit configuration"
TPE3, TPE3 D	•
TPE2, TPE2 D	•

In this menu you can select between SI and US units. The setting can be made generally for all parameters or customized for each individual parameter.

#### Factory setting

See section [35. Factory settings](#).

### 17.35 "Buttons on product" (Enable/disable settings)

Pump variant	"Buttons on product" (Enable/disable settings)
TPE3, TPE3 D	•
TPE2, TPE2 D	•

In this display, you can disable the possibility of making settings.



#### Grundfos GO

If you set the buttons to "Not active", the buttons on the standard control panel are disabled. If you set the buttons to "Not active" on pumps with an advanced control panel, see below.

#### Advanced control panel

If you have disabled the settings, you can still use the buttons to navigate through the menus but you cannot make changes in the Settings menu.

When you have disabled the possibility to make settings, the  symbol appears in the display.

To unlock the pump and allow settings, press  and  simultaneously for at least 5 seconds.

#### Standard control panel

The  button always remains active but you can only unlock all other buttons on the pump with Grundfos GO.

### 17.36 Delete history

Pump variant	Delete history
TPE3, TPE3 D	•
TPE2, TPE2 D	•

This menu is only available in the advanced control panel.

In this menu, you can delete the following historic data:

- "Delete work log".
- "Delete heat energy data".
- "Delete energy consumption".

### 17.37 Define Home display

Pump variant	Define Home display
TPE3, TPE3 D	•
TPE2, TPE2 D	•

This menu is only available in the advanced control panel.

In this menu, you can set the Home display to show up to four user-set parameters.

### 17.38 Display settings

Pump variant	Display settings
TPE3, TPE3 D	•
TPE2, TPE2 D	•

This menu is only available in the advanced control panel.

In this menu you can adjust the display brightness and set whether or not the display is to turn off if no buttons have been activated for a period of time.

### 17.39 "Store settings" (Store actual settings)

Pump variant	Store actual settings
TPE3, TPE3 D	•
TPE2, TPE2 D	•

#### Grundfos GO

In this menu, you can store the actual settings for later use in the same pump or in other pumps of the same type.

#### Advanced control panel

In this menu, you can store the actual settings for later use in the same pump.

### 17.40 "Recall settings" (Recall stored settings)

Pump variant	"Recall settings" (Recall stored settings)
TPE3, TPE3 D	•
TPE2, TPE2 D	•

#### Grundfos GO

In this menu, you can recall stored settings from a number of previously stored settings that the pump then uses.

#### Advanced control panel

In this menu, you can recall the last stored settings that the pump then uses.

### 17.41 "Undo"

Pump variant	"Undo"
TPE3, TPE3 D	•
TPE2, TPE2 D	•

This menu is only available in Grundfos GO.

In this display, you can undo all settings that have been made with Grundfos GO in the current communication session. You cannot undo a Recall stored settings action.

### 17.42 "Pump name"

Pump variant	"Pump name"
TPE3, TPE3 D	•
TPE2, TPE2 D	•

This menu is only available in Grundfos GO.

In this display, you can give the pump a name. In this way, you can easily identify the pump when connecting with Grundfos GO.

#### Factory setting

See section [35. Factory settings](#).

### 17.43 "Connection code"

Pump variant	"Connection code"
TPE3, TPE3 D	•
TPE2, TPE2 D	•

This menu is only available in Grundfos GO.

You can set a connection code to avoid having to press the connection button each time and to restrict remote access to the product.

#### Setting the code in the product using Grundfos GO

1. Connect Grundfos GO to the product.
2. In the product dashboard, select "Settings".
3. Choose "Connection code".
4. Enter the wanted code and press [OK].  
The code must be a character string, ASCII.  
You can always modify the code. The old code is not needed.

## Setting the code in Grundfos GO

You can set a default connection code in Grundfos GO so that it automatically attempts to connect to the selected product via this code.

When you select a product with the same connection code in Grundfos GO, Grundfos GO automatically connects to the product and you do not have to press the connection button on the module.

Set the default code in Grundfos GO in this way:

1. In the main menu, under "General", select "Settings".
2. Choose "Remote".
3. Enter the connection code in the field "Preset connection code". The field now says "Connection code set".

You can always modify the default connection code by pressing [Delete] and entering a new one.

If Grundfos GO fails to connect and ask you to press the connection button on the product, it means that the product has no connection code or has a different connection code. In this case, you can only establish connection via the connection button.

After setting a connection code, you must switch off the product until the light in Grundfos Eye turns off before you can use the new connection code.

### Factory setting

See section [35. Factory settings](#).

## 17.44 Run start-up guide

Pump variant	Run start-up guide
TPE3, TPE3 D	•
TPE2, TPE2 D	•

This menu is only available in the advanced control panel.

The startup guide automatically starts when you start the pump for the first time.

You can always run the startup guide later via this menu.

The startup guide guides you through the general settings of the pump.

- Language. See section [17.32 Language](#).
- Select date format.\*  
See section [17.33 "Date and time" \(Set date and time\)](#).
- Set date.\*  
See section [17.33 "Date and time" \(Set date and time\)](#).
- Select time format.\*  
See section [17.33 "Date and time" \(Set date and time\)](#).
- Set time.\*  
See section [17.33 "Date and time" \(Set date and time\)](#).
- Setting of pump
  - Go to Home.
  - Run with Constant curve/Run with Constant pressure.  
See section [17.6 Control mode](#).
  - Go to "Assisted pump setup".  
See section [17.48 Assisted pump setup](#).
  - Return to factory settings.

\*Applies only for pumps with advanced functional module, FM 300. For further information, see section [24. Identification of functional module](#).

## 17.45 Alarm log

Pump variant	Alarm log
TPE3, TPE3 D	•
TPE2, TPE2 D	•

This menu contains a list of logged alarms from the product. The log shows the name of the alarm, when the alarm occurred and when it was reset.

## 17.46 Warning log

Pump variant	Warning log
TPE3, TPE3 D	•
TPE2, TPE2 D	•

This menu contains a list of logged warnings from the product. The log shows the name of the warning, when the warning occurred and when it was reset.

## 17.47 Assist

Pump variant	Assist
TPE3, TPE3 D	•
TPE2, TPE2 D	•

The menu consist of functions which take you through the steps needed to set the pump.

## 17.48 Assisted pump setup

Pump variant	Assisted pump setup
TPE3, TPE3 D	•
TPE2, TPE2 D	•

The menu guides you through the following:

### Setting of pump

- Selection of control mode. See page [30](#).
- Configuration of feedback sensors.
- Adjusting the setpoint. See page [29](#).
- Controller settings. See page [41](#).
- Summary of settings.

### Example of how to use the Assisted pump setup for setting up the pump to constant pressure:

#### Grundfos GO

1. Open the Assist menu.
2. Select Assisted pump setup.
3. Select the control mode "Constant pressure".
4. Read the description of this control mode.
5. Select which analog input to use as sensor input.
6. Select sensor function according to where the sensor is installed in the system. See fig. 54.
7. Select electrical input signal according to the sensor specifications.
8. Select measuring unit according to the sensor specifications.
9. Set the minimum and maximum sensor values according to the sensor specifications.
10. Set the desired setpoint.
11. Set the controller settings  $K_p$  and  $T_i$ . See the recommendations in section 17.18 "Controller" ("Controller settings").
12. Type the pump name.
13. Check the summary of settings and confirm them.

#### Advanced control panel

1. Open the Assist menu.
2. Select Assisted pump setup.
3. Select the control mode Const. pressure.
4. Select which analog input to be used as sensor input.
5. Select the measured parameter to be controlled. See fig. 54.
6. Select measuring unit according to the sensor specifications.
7. Set the minimum and maximum sensor values according to the sensor specifications.
8. Select electrical input signal according to the sensor specifications.
9. Set the setpoint.
10. Set the controller settings  $K_p$  and  $T_i$ . See recommendations in section 17.18 "Controller" ("Controller settings").
11. Check the summary of settings and confirm them by pressing [OK].

### 17.49 Setup, analog input

Pump variant	Setup, analog input
TPE3, TPE3 D	•
TPE2, TPE2 D	•

This menu is only available in the advanced control panel.

The menu guides you through the following:

#### Setup, analog input

- Analog inputs 1 to 3. See page 36.
- Pt100/1000 input 1 and 2. See page 38.
- Adjusting the setpoint. See page 29.
- Summary.

### 17.50 Setting of date and time

Pump variant	Setting of date and time
TPE3, TPE3 D	•
TPE2, TPE2 D	•

This menu guides you through the following:

- Select date format. See section 17.33 "Date and time" (Set date and time).
- Set date. See section 17.33 "Date and time" (Set date and time).
- Select time format. See section 17.33 "Date and time" (Set date and time).
- Set time. See section 17.33 "Date and time" (Set date and time).

### 17.51 "Multipump setup" (Setup of multi-pump system)

Pump variant	"Multipump setup" (Setup of multi-pump system)
TPE3, TPE3 D	•
TPE2, TPE2 D	•

The multipump function enables the control of two pumps connected in parallel without the use of external controllers. The pumps in a multipump system communicate with each other via the wireless GENIair connection or the wired GENI connection.

A multipump system is set via a selected pump, such as the master pump which is the first selected pump.

If two pumps in the system are configured with an outlet-pressure sensor, both pumps can function as master pumps and take over the master pump function if the other fails. This provides additional redundancy in the multipump system.

The multipump functions are described in the following sections.

#### 17.51.1 Alternating operation

Alternating operation functions as a duty-standby operating mode and is possible with two pumps of same size and type connected in parallel. The main purpose of the function is to ensure an even amount of running hours and to ensure that the standby pump takes over if the running pump stops due to an alarm.

Each pump requires a check valve in series with the pump.

You can choose between two alternating operation modes:

- Alternating operation, time  
Pump changeover to the other is based on time.
- Alternating operation, energy  
Pump changeover to the other is based on energy consumption.

If the duty pump fails, the other pump takes over automatically.

### 17.51.2 Backup operation

Backup operation is possible with two pumps of same size and type connected in parallel. Each pump requires a check valve in series with the pump.

One pump is operating continuously. The backup pump is operated for a short time each day to prevent seizing up. If the duty pump stops due to a fault, the backup pump starts automatically.

### 17.51.3 Cascade operation

Cascade operation ensures that the pump performance is automatically adapted to the consumption by switching pumps on or off. The system thus runs as energy-efficiently as possible with a constant pressure and a limited number of pumps.

When a twin-head pump is running in constant pressure control mode, the second pump head starts at 90 % and stops at 50 % performance.

All pumps in operation run at equal speed. Pump changeover is automatic and depends on energy, operating hours and fault.

Pump system:

- Twin-head pump.
- Two or four single-head pumps connected in parallel. The pumps must be of the same type and size. Each pump requires a non-return valve in series with the pump.

Set the control mode to "Const. pressure" or "Const. curve".

This function is available with up to 4 motors installed in parallel. The motors must be of the same size and the pumps must be of the same model.

- The performance is adjusted to the demand through cutting pumps in or out and through parallel control of the pumps in operation.
- The controller maintains a constant pressure through continuous adjustment of the speed of the pumps.
- Pump changeover is automatic and depends on load, operating hours and fault detection.
- All pumps in operation run at the same speed.
- The number of pumps in operation also depends on the energy consumption of the pumps. If only one pump is required, two pumps will run at a lower speed if this results in a lower energy consumption.
- If several motors in the system have a sensor, they can all function as master and take over the master function if the other fails.

### 17.51.4 Sensor to be used

Define the sensor to be used for controlling the pump system. If a sensor is placed in a way that it is able to measure the sensor output from all pumps in the system, for example, in the manifold, then select "Master pump sensor".

If a sensor is placed on, or across the individual pumps, for example, installed behind non-return valves and not able to measure the sensor output from all pumps, then select "Running pump sensor".

### 17.51.5 Setting a multipump system

You can set a multipump system in the following ways:

- [Grundfos GO and wireless pump connection](#)
- [Grundfos GO and wired pump connection](#)
- [Advanced control panel and wireless pump connection](#)
- [Advanced control panel and wired pump connection](#)

See step-by-step descriptions below.

#### Grundfos GO and wireless pump connection

1. Power on both pumps.
2. Establish contact to one of the pumps with Grundfos GO.
3. Set the needed analog and digital inputs via Grundfos GO according to the connected equipment and the required functionality. See section [17.48 Assisted pump setup](#).
4. Assign a pump name to the pump using Grundfos GO. See section [17.42 "Pump name"](#).
5. Disconnect Grundfos GO from the pump.
6. Establish contact to the other pump.
7. Set the needed analog and digital inputs via Grundfos GO according to the connected equipment and the required functionality. See section [17.48 Assisted pump setup](#).
8. Assign a pump name to the pump using Grundfos GO. See section [17.42 "Pump name"](#).
9. Select the "Assist" menu and "Multipump setup".
10. Select the desired multipump function. See sections [17.51.1 Alternating operation](#), [17.51.2 Backup operation](#) and [17.51.3 Cascade operation](#).
11. Press [>] to continue.
12. Set the time for pump changeover such as the time at which the alternation between the two pumps is to take place. This step applies only if you have selected "Alternating operation, time" and if the pumps are fitted with FM 300.
13. Press [>] to continue.
14. Select "Radio" as the communication method to be used between the two pumps.
15. Press [>] to continue.
16. Press "Select pump 2".
17. Select the pump from the list. Use the [OK] or  button to identify the pump.
18. Press [>] to continue.
19. Confirm the multipump setup by pressing [Send].
20. Press [Finish] in the "Setup complete" dialog box.
21. Wait for the green indicator light in the middle of Grundfos Eye to light up.

The multipump system has now been set.

### Grundfos GO and wired pump connection

1. Connect the two pumps with each other with a 3-core screened cable between the GENIbus terminals A, Y, B.
2. Power on both pumps.
3. Establish contact to one of the pumps with Grundfos GO.
4. Set the needed analog and digital inputs via Grundfos GO according to the connected equipment and the required functionality. See section [17.48 Assisted pump setup](#).
5. Assign a pump name to the pump using Grundfos GO. See section [17.42 "Pump name"](#).
6. Assign pump number 1 to the pump. See section [17.30 "Number" \(Pump number\)](#).
7. Disconnect Grundfos GO from the pump.
8. Establish contact to the other pump.
9. Set the needed analog and digital inputs via Grundfos GO according to the connected equipment and the required functionality. See section [17.48 Assisted pump setup](#).
10. Assign a pump name to the pump using Grundfos GO. See section [17.42 "Pump name"](#).
11. Assign pump number 2 to the pump. See section [17.30 "Number" \(Pump number\)](#).
12. Select the "Assist" menu and choose "Multipump setup".
13. Select the desired multipump function. See sections [17.51.1 Alternating operation](#), [17.51.2 Backup operation](#) and [17.51.3 Cascade operation](#).
14. Press [>] to continue.
15. Set the time for pump changeover such as the time at which the alternation between the two pumps is to take place. This step applies only if you have selected "Alternating operation, time" and if the pumps are fitted with FM 300.
16. Press [>] to continue.
17. Select "BUS cable" as the communication method to be used between the two pumps.
18. Press [>] to continue.
19. Press "Select pump 2".
20. Select the additional pump from the list.  
Use the [OK] or  button to identify the pump.
21. Press [>] to continue.
22. Press [Send].
23. Press [Finish] in the "Setup complete" dialog box.
24. Wait for the green indicator light in the middle of Grundfos Eye to light up.

The multipump system has now been set.

### Advanced control panel and wireless pump connection

1. Power on both pumps.
2. On both pumps, set the needed analog and digital inputs according to the connected equipment and the required functionality. See section [17.48 Assisted pump setup](#).
3. Select the Assist menu on one of the pumps and choose Setup of multi-pump system.
4. Press [>] to continue.
5. Select Wireless as the communication method to be used between the two pumps.
6. Press [>] to continue.
7. Select the desired multipump function. See sections [17.51.1 Alternating operation](#), [17.51.2 Backup operation](#) and [17.51.3 Cascade operation](#).
8. Press [>] three times to continue.
9. Press [OK] to search for other pumps.  
The green indicator light in the middle of Grundfos Eye flashes on the other pumps.
10. Press the connect button on the pump which is to be added to the multipump system.
11. Press [>] to continue.
12. Set the time for pump changeover such as the time at which the alternation between the two pumps is to take place. This step applies only if you have selected "Alternating operation, time" and if the pumps are fitted with FM 300.
13. Press [>] to continue.
14. Press [OK].  
The multipump function icons appear in the bottom of the control panels.

The multipump system has now been set.

### Advanced control panel and wired pump connection

1. Connect the two pumps with each other with a 3-core screened cable between the GENIbus terminals A, Y, B.
2. Set the needed analog and digital inputs according to the connected equipment and the required functionality. See section [17.48 Assisted pump setup](#).
3. Assign pump number 1 to the first pump. See section [17.30 "Number" \(Pump number\)](#).
4. Assign pump number 2 to the other pump. See section [17.30 "Number" \(Pump number\)](#).
5. Select the Assist menu on one of the pumps and choose Setup of multi-pump system.
6. Press [>] to continue.
7. Select Wired GENIbus as the communication method to be used between the two pumps.
8. Press [>] twice to continue.
9. Select the desired multipump function. See sections [17.51.1 Alternating operation](#), [17.51.2 Backup operation](#) and [17.51.3 Cascade operation](#).
10. Press [>] to continue.
11. Press [OK] to search for other pumps.
12. Select the additional pump from the list.
13. Press [>] to continue.
14. Set the time for pump changeover such as the time at which the alternation between the two pumps is to take place. This step applies only if you have selected "Alternating operation, time" and if the pumps are fitted with FM 300.
15. Press [>] to continue.
16. Press [OK].  
The multipump function icons will appear in the bottom of the control panels.

The multipump system has now been set.

### Disabling the multipump function via Grundfos GO

1. Select the "Assist" menu.
2. Select "Multipump setup".
3. Select "Disable".
4. Press [>] to continue.
5. Confirm the multipump setup by pressing [Send].
6. Press [Finish].

The multipump function has now been disabled.

### Disabling a multipump via advanced control panel

1. Select the Assist menu.
2. Select Setup of multi-pump system.
3. Press [>] to continue.
4. Confirm No multi-pump function by pressing [OK].
5. Press [>] to continue.
6. Press [OK].

The multipump system has now been disabled.

### 17.52 Description of control mode

Pump variant	Description of control mode
TPE3, TPE3 D	•
TPE2, TPE2 D	•

This menu is only available in the advanced control panel.

This menu describes each of the possible control modes. See also section [17.6 Control mode](#).

### 17.53 Assisted fault advice

Pump variant	Assisted fault advice
TPE3, TPE3 D	•
TPE2, TPE2 D	•

This menu gives guidance and corrective actions in case of pump failures.

## 18. Selecting control mode

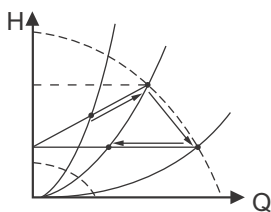
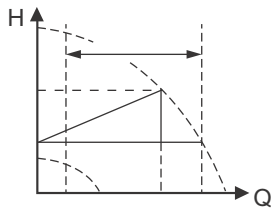
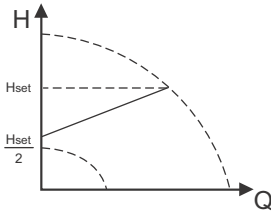
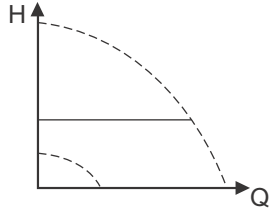
System application	Select this control mode
<p>Recommended for most heating systems, especially in systems with relatively large pressure losses in the distribution pipes. See description under proportional pressure.</p> <p>In replacement situations where the proportional-pressure duty point is unknown.</p> <p>The duty point has to be within the <math>AUTO_{ADAPT}</math> operating range. During operation, the pump automatically adjusts to the actual system characteristic.</p> <p>This setting ensures minimum energy consumption and low noise level from valves, which reduces operating costs and increases comfort.</p>	<p style="text-align: center;"><math>AUTO_{ADAPT}</math></p> 
<p>The <math>FLOW_{ADAPT}</math> control mode is a combination of <math>AUTO_{ADAPT}</math> and <math>FLOW_{LIMIT}</math>.</p> <p>This control mode is suitable for systems where you want a maximum flow limit, <math>FLOW_{LIMIT}</math>.</p> <p>The pump continuously monitors and adjusts the flow, thus ensuring that the selected <math>FLOW_{LIMIT}</math> is not exceeded.</p> <p>Main pumps in boiler applications where a steady flow through the boiler is required. No extra energy is used for pumping too much liquid into the system.</p> <p>In systems with mixing loops, you can use the control mode to control the flow in each loop.</p>	<p style="text-align: center;"><math>FLOW_{ADAPT}</math></p> 
<p><b>Benefits</b></p> <ul style="list-style-type: none"> <li>• Enough water for all loops at peak load conditions if you have set each loop to the right maximum flow.</li> <li>• The dimensioned flow for each zone, required heat energy, is determined by the flow from the pump. You can set this value precisely in the <math>FLOW_{ADAPT}</math> control mode without the use of pump throttling valves.</li> <li>• When the flow is set lower than the balancing valve setting, the pump ramps down instead of losing energy by pumping against a balancing valve.</li> <li>• Cooling surfaces in air-conditioning systems can operate at high pressure and low flow.</li> </ul>	<p style="text-align: center;">Proportional pressure</p> 
<p>In systems with relatively small pressure losses in the distribution pipes.</p> <ul style="list-style-type: none"> <li>• Two-pipe heating systems with thermostatic valves and the following: <ul style="list-style-type: none"> <li>– sized for natural circulation</li> <li>– small pressure losses in those parts of the system through which the total quantity of water flows, for example boiler, heat exchanger and distribution pipe up to the first branching or modified to a high differential temperature between flow pipe and return pipe, for example district heating.</li> </ul> </li> <li>• Underfloor heating systems with thermostatic valves.</li> <li>• One-pipe heating systems with thermostatic valves or pipe balancing valves.</li> <li>• Primary circuit pumps in systems with small pressure losses in the primary circuit.</li> </ul>	<p style="text-align: center;">Constant differential pressure</p> 

**System application**

In systems with a fixed system characteristic.

**Examples**

- one-pipe heating systems
- boiler shunts
- systems with three-way valves
- domestic hot-water circulation.

You can use  $FLOW_{LIMIT}$  with advantage to control the maximum circulation flow.

**Select this control mode**

Constant temperature and constant differential temperature

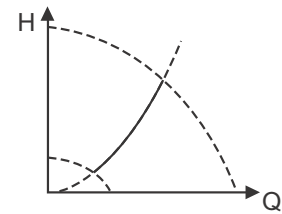

If an external controller is installed, the pump is able to change from one constant curve to another, depending on the external signal.

You can also set the pump to operate according to the maximum or minimum curve, like an uncontrolled pump:

- Use the maximum-curve mode in periods in which a maximum flow is required. This operating mode is for instance suitable for hot-water priority.
- You can use the minimum-curve mode in periods in which a minimum flow is required. This operating mode is for instance suitable for manual night setback if you do not want automatic night setback.

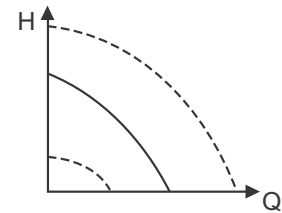
**Constant curve****Constant flow rate**

In systems requiring a constant flow, independently of pressure drop.

**Examples**

- chillers for air-conditioning
- heating surfaces
- cooling surfaces.

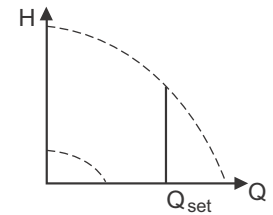
**Constant level**

In systems requiring a constant tank level, independently of the flow rate.

**Examples**

- process water tanks
- boiler condensate tanks.

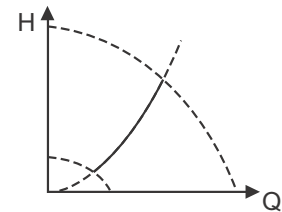

In systems with pumps operating in parallel.

The multipump function enables the control of two to four single-head pumps connected in parallel and twin-head pumps without the use of external controllers. The pumps in a multipump system communicate with each other via the wireless GENIair connection or the wired GENI connection.

"Assist" menu  
"Multipump setup"

## 19. Bus signal

The pump supports serial communication via an RS-485 input. The communication is carried out according to the Grundfos GENIbus protocol and enables connection to a other pumps as well as a building management system or another external control system.



Via a bus signal, you can remote-set pump operating parameters, such as setpoint and operating mode. At the same time, the pump can, via the bus, provide status information about important parameters, such as actual value of control parameter, input power and fault indications.

Contact Grundfos for further information.



If you use a bus signal, the number of settings available via Grundfos Go are reduced.

## 20. Priority of settings

You can always set the pump to stop by pressing  on the pump control panel. When the pump is not in Stop mode, you can always stop the pump by continuously pressing . Furthermore, you can set the pump to maximum speed by continuously pressing . You can always set the pump to operation at maximum speed or to stop with Grundfos GO.

If two or more functions are enabled at the same time, the pump will operate according to the function with the highest priority.

### Example

If you have set the pump to maximum speed via the digital input, the pump control panel or Grundfos GO can only set the pump to Manual or Stop.

The priority of the settings appears from the table below.

Priority	Start-stop button	Grundfos GO or control panel on the motor	Digital input	Bus communication
1	Stop			
2		Stop*		
3		Manual		
4		"Max. speed"*/ "User-defined speed"		
5			Stop	
6			"User-defined speed"	
7				Stop
8				"Max. speed"
9				"Min. speed"
10				"Start"
11			"Max. speed"	
12		"Min. speed"		
13			"Min. speed"	
14			"Start"	
15		"Start"		

\* "Stop" and "Max. speed" settings made with Grundfos GO or on the motor control panel can be overruled by another operating-mode command sent from a bus, for example "Start". If the bus communication is interrupted, the motor resumes its previous operating mode, for example "Stop", selected with Grundfos GO or on the motor control panel.

## 21. Grundfos Eye

The operating condition of the pump is indicated by Grundfos Eye on the control panel. See fig. 69. A.

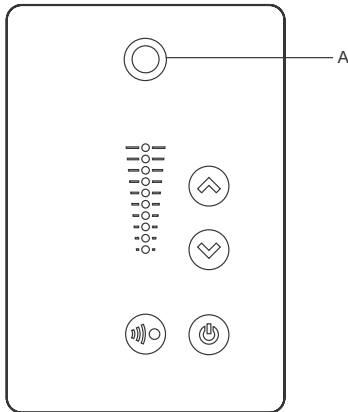

TM05 5993 4312

Fig. 69 Grundfos Eye











Grundfos Eye	Indication	Description
	No lights on.	The power is off. The pump is not running.
	The two opposite green indicator lights are rotating in the direction of rotation of the pump when seen from the non-drive end.	The power is on. The pump is running.
	The two opposite green indicator lights are permanently on.	The power is on. The pump is not running.
	One yellow indicator light is rotating in the direction of rotation of the motor when seen from the non-drive end.	Warning. The pump is running.
	One yellow indicator light is permanently on.	Warning. The pump has stopped.
	The two opposite red indicator lights are flashing simultaneously.	Alarm. The pump has stopped.
	The green indicator light in the middle flashes quickly four times.	This is a feedback signal which the pump gives in order to ensure identification of itself.
	The green indicator light in the middle flashes continuously.	Grundfos GO or another pump is trying to communicate with the pump. Press  on the pump control panel to allow communication.
	The green indicator light in the middle is permanently on.	Remote control with the Grundfos GO via radio. The pump is communicating with Grundfos GO via radio connection.
	The green indicator light in the middle flashes quickly while the Grundfos Go is exchanging data with the pump. It takes a few seconds.	Remote control with Grundfos GO via infrared light. The pump is receiving data from Grundfos GO via infrared communication.

## 22. Signal relays

The pump has two outputs for potential-free signals via two internal relays.

You can set the signal outputs to Operation, Pump running, Ready, Alarm and Warning.

The functions of the two signal relays appear from the table below:

Description	Grundfos Eye	Contact position for signal relays when activated					Operating mode
		Operation	Pump running	Ready	Alarm	Warning	
The power is off.	 Off						-
The pump runs in Normal mode.	 Green, rotating						Normal, Min. or Max.
The pump runs in Manual mode.	 Green, rotating						Manual
The pump is in operating mode Stop.	 Green, steady						Stop
Warning, but the pump runs.	 Yellow, rotating						Normal, Min. or Max.
Warning, but the pump runs in Manual mode.	 Yellow, rotating						Manual
Warning, but the pump was stopped via Stop command.	 Yellow, steady						Stop
Alarm, but the pump runs.	 Red, rotating						Normal, Min. or Max.
Alarm, but the pump runs in Manual mode.	 Red, rotating						Manual
The pump has stopped due to an alarm.	 Red, flashing						Stop

## 23. Installing a communication interface module

### DANGER

#### Electric shock



Death or serious personal injury

- Switch off the power supply to the motor and to the signal relays. Wait at least 5 minutes before starting any work on the motor. Make sure that the power supply cannot be accidentally switched on.



Always use an antistatic service kit when handling electronic components. This prevents static electricity from damaging the components. When unprotected, place the component on the antistatic cloth.

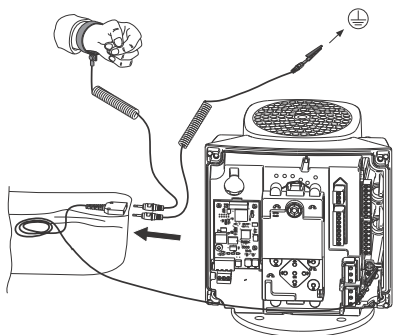

Fig. 70 Antistatic service kit

1. Loosen the four screws (fig. 71, A) and remove the terminal box cover (fig. 71, B).

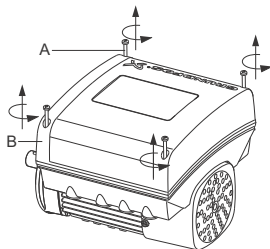

Fig. 71 Removing the terminal box cover

2. Remove the CIM cover (fig. 72, A) by pressing the locking tab (fig. 72, B) and lifting the end of the cover (fig. 72, C). Then lift the cover off the hooks (fig. 72, D).

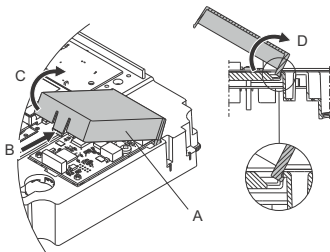

Fig. 72 Removing the CIM cover

3. Remove the securing screw (fig. 73, A).

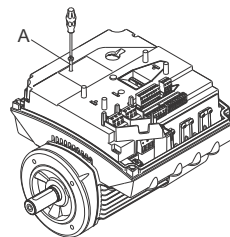

Fig. 73 Removing the securing screw

4. Fit the CIM module by aligning it with the three plastic holders (fig. 74, A) and the connecting plug (fig. 74, B). Press home the module using your fingers.

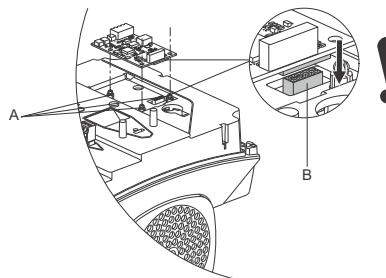

Fig. 74 Fitting the CIM module

5. Fit and tighten the securing screw (fig. 73, A) to 1.3 Nm.
6. Make the electrical connections to the CIM module as described in the instructions delivered with the module.
7. Connect the cable screens of the bus cables to ground via one of the ground clamps (fig. 75, A).

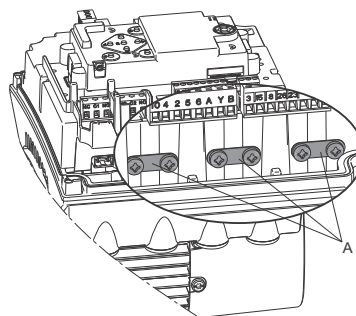

Fig. 75 Connecting the cable screens to ground

8. Route the wires for the CIM module. See the example in fig. 76.

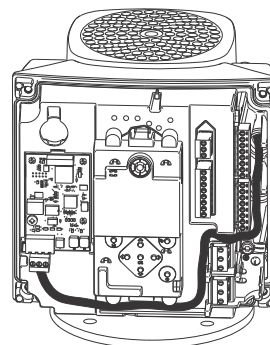

Fig. 76 Example of wire routing

TM06 4462 2315

TM06 4081 1515

TM06 4084 1515

TM06 4082 1515

TM06 4083 1515

TM06 4195 1615

TM06 4085 1515

- 9. Fit the CIM cover.
- 10. If the CIM module is supplied with an FCC label, then place this on the terminal box. See fig. 77.

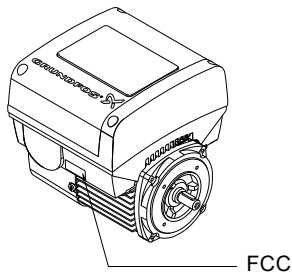

Fig. 77 FCC label

- 11. Fit the terminal box cover (fig. 71, B) and cross-tighten the four mounting screws (fig. 71, A) to 6 Nm.



Make sure that the terminal box cover is aligned with the control panel. See section 26. *Changing the position of the control panel.*

**24. identification of functional module**

You can identify the module in one of the following ways:

**Grundfos GO**

Select the Module typemenu under Status.

**Pump display**

If the pump is fitted with the advanced control panel, select Module typemenu under Status.

**Motor nameplate**

You can identify the fitted module on the motor nameplate. See fig. 78.

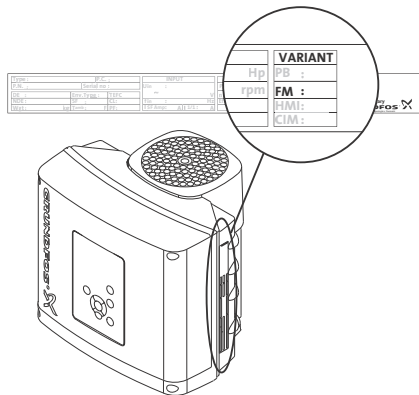

Fig. 78 Identification of functional module

Variant	Description
FM 200	Standard functional module
FM 300	Advanced functional module

TM05 7028 0413

TM06 1889 3314

**25. Identification of control panel**

You can identify the module in one of the following ways:

**Grundfos GO**

Select the Module type menu under Status.

**Pump display**

For pumps fitted with the advanced control panel, you can select the control panel in the Module typemenu under Status.

**Motor nameplate**

You can identify the control panel on the motor nameplate. See fig. 79.

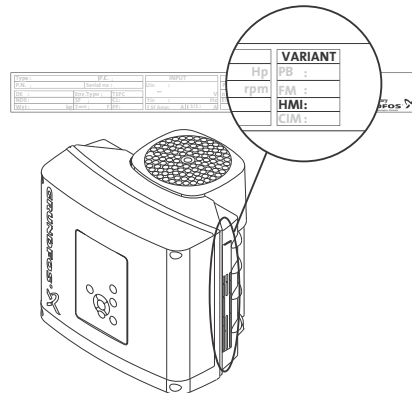

Fig. 79 Identification of control panel

Variant	Description
HMI 200	Standard control panel
HMI 300	Advanced control panel

TM06 4013 1415

## 26. Changing the position of the control panel

### DANGER

#### Electric shock



Death or serious personal injury

- Switch off the power supply to the motor and to the signal relays. Wait at least 5 minutes before starting any work on the motor. Make sure that the power supply cannot be accidentally switched on.

You can turn the control panel 180°. Follow the instructions below.

1. Loosen the four screws, TX25, of the terminal box cover.

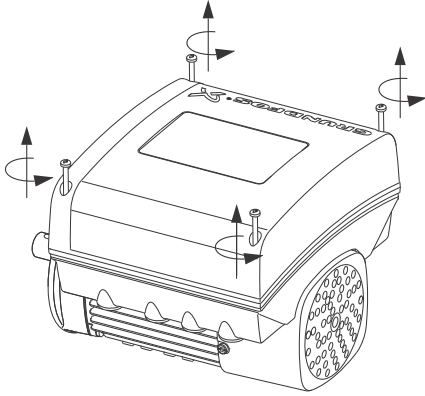

Fig. 80 Loosening the screws

2. Remove the terminal box cover.

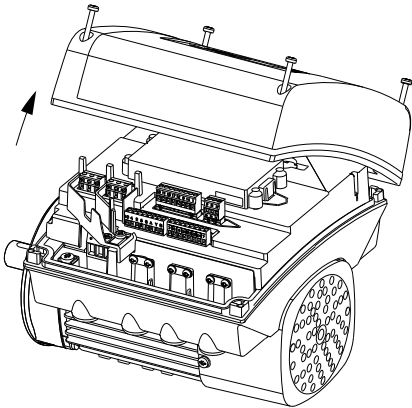

Fig. 81 Removing the terminal box cover

3. Press and hold in the two locking tabs, A, while gently lifting the plastic cover, B.

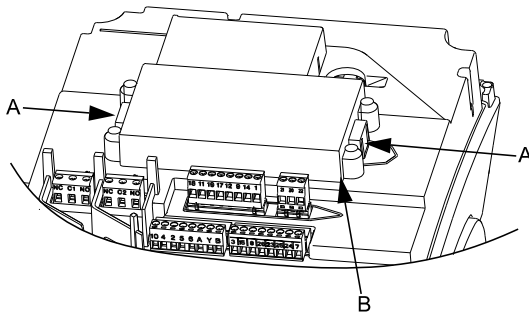

Fig. 82 Lifting the plastic cover

4. Turn the plastic cover 180°.



Do not twist the cable more than 90°.

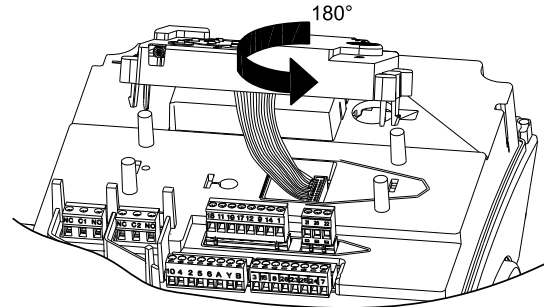

Fig. 83 Turning the plastic cover

5. Position the plastic cover correctly on the four rubber pins, C. Make sure that the locking tabs, A, are placed correctly.

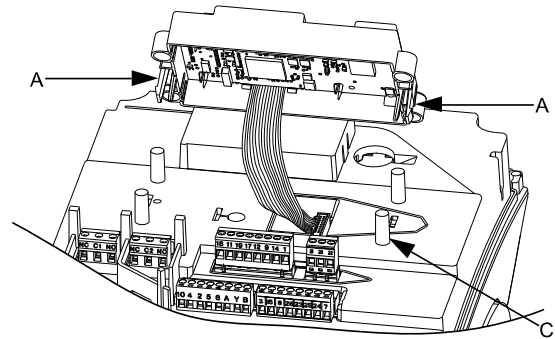

Fig. 84 Re-positioning the plastic cover

6. Fit the terminal box cover, and make sure that it is also turned 180° so that the buttons on the control panel are aligned with the buttons on the plastic cover.
7. Tighten the four screws (TX25) with 3.69 lbf-ft (5 Nm).

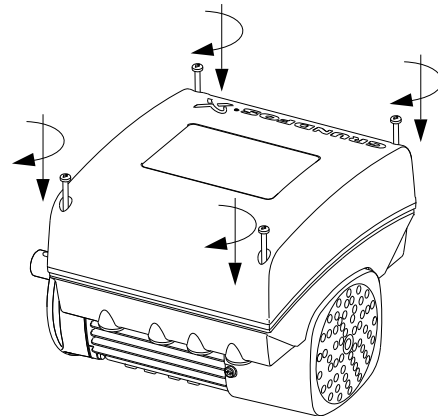

Fig. 85 Fitting the terminal box cover

## 27. Servicing the product

### DANGER

#### Electric shock



- Death or serious personal injury
- Switch off the power supply to the motor and to the signal relays. Wait at least 5 minutes before starting any work on the motor. Make sure that the power supply cannot be accidentally switched on.

### DANGER

#### Magnetic field



- Death or serious personal injury
- Do not handle the motor or rotor if you have a pacemaker.

### DANGER

#### Hazardous liquids



- Death or serious personal injury
- If the pump is used for a liquid which is injurious to health, it will be classified as contaminated. In such cases, take proper precautions to avoid injury to health when operating or working on the pump.
  - Wear personal protection equipment.

### CAUTION

#### Hot or cold liquids



- Minor or moderate personal injury
- Wear personal protection equipment.

## 27.1 Maintenance

### 27.1.1 Pump

The pump is maintenance-free.

If the pump is to be drained for a long period of inactivity, inject a few drops of silicone oil on the shaft between the motor stool and the coupling. This prevents the shaft seal faces from sticking.

Pumps with BQQE shaft seal must be operated minimum once every month in minimum 5 minutes to prevent the shaft seal faces from sticking.

### 27.1.2 Motor

If service is needed on the product, please contact Grundfos Service.

## 27.2 Service

If Grundfos is requested to service the pump, you must clean it must before returning it. If you cannot clean the pump properly, then provide Grundfos with all relevant information about the pumped liquid.

If the above is not fulfilled, Grundfos can refuse to accept the pump for service.

Possible costs of returning the pump are to be paid by the customer.

### 27.2.1 Integral shaft and coupling

TPE2 and TPE3 pumps have integral shaft and coupling. We recommend that you do not remove the motor.

If you have removed the motor, you must remove the motor stool in order to refit the motor correctly. Otherwise the shaft seal may be damaged.

### 27.2.2 Blanking flanges

For twin-head pumps, a blanking flange with a pump casing gasket is available. See fig. 86.

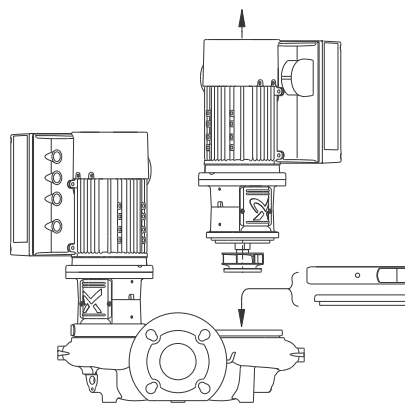

Fig. 86 Fitting the blanking flange

If one pump requires service, fit the blanking flange to allow the other pump to continue operating.

## 28. Cleaning the product

### WARNING

#### Electric shock



- Death or serious personal injury
- Switch off the power supply to the motor and to the signal relays. Check that the terminal box cover is intact before spraying water on the product.

In order to avoid condensation in the motor, let the motor cool down before spraying it with cold water.

TM05 7921 1613

## 29. Fault finding



**DANGER**  
**Electric shock**

Death or serious personal injury  
- Switch off the power supply to the motor and to the signal relays. Wait at least 5 minutes before starting any work on the motor. Make sure that the power supply cannot be accidentally switched on.



**DANGER**  
**Magnetic field**

Death or serious personal injury  
- Do not handle the motor or rotor if you have a pacemaker.



**WARNING**  
**Hazardous liquids**

Death or serious personal injury  
- If the pump is used for a liquid which is injurious to health, it will be classified as contaminated. In such cases, take proper precautions to avoid injury to health when operating or working on the pump.  
- Wear personal protection equipment.



**CAUTION**  
**Hot or cold liquids**

Minor or moderate personal injury  
- Wear personal protection equipment.

Fault	Cause and remedy
1. The motor does not run when started.	a) Supply failure. b) The fuses are blown. c) The motor is defective.
2. Motor alarm when the power supply is switched on.	a) Supply failure. b) The cable connection is loose or faulty. c) The motor winding is defective. d) The pump is mechanically blocked.
3. Occasional motor alarm.	a) The supply voltage is periodically too low or too high. b) The differential pressure across pump is too low.
4. No motor alarm, but the pump does not run.	a) Check the power supply. b) Check fuses.
5. The pump performance is not constant.	a) The pump inlet pressure is too low. b) The inlet pipe or pump is partly blocked by impurities. c) The pump draws in air.
6. The pump runs but delivers no water.	a) The inlet pipe or pump is blocked by impurities. b) The foot or check valve is blocked in closed position. c) There is a leakage in the inlet pipe. d) There is air in the inlet pipe or pump.
7. The pump runs backwards when switched off.*	a) There is a leakage in the inlet pipe. b) The foot or check valve is defective. c) The foot or check valve is blocked in open or partly open position.
8. Leakage in shaft seal.	a) The shaft seal is defective.
9. Noise.	a) The pump is cavitating. b) The pump does not rotate freely (frictional resistance) because of incorrect pump shaft position. c) There is resonance in the installation. d) There are foreign bodies in the pump.

\* In twin-head pump installations, the backup pump often rotates slowly.

## 30. Megging



Megging of an installation incorporating MLE motors is not allowed, as the built-in electronics may be damaged.

## 31. Technical data, single-phase motors

### 31.1 Supply voltage

- 1 x 200-240 V - 10 %/+ 10 %, 60 Hz, PE.

Confirm that the supply voltage and frequency correspond to the values stated on the nameplate.

#### Recommended fuse size

Motor size [hp (kW)]	Min. [A]	Max. [A]
0.33 - 1.0 (0.25 - 0.75)	6	10
1.5 - 2.0 (1.1 - 1.5)	10	16

You can use standard as well as quick-blow or slow-blow fuses.

### 31.2 Leakage current

Ground leakage current less than 3.5 mA, AC.

Ground leakage current less than 10 mA, DC.

The leakage currents are measured in accordance with EN 61800-5-1:2007.

## 32. Technical data, three-phase motors

### 32.1 Supply voltage

- 3 x 440-480 V - 10 %/+ 10 %, 60 Hz, PE.

Check that the supply voltage and frequency correspond to the values stated on the nameplate.

#### Recommended fuse size

Motor size [hp (kW)]	Min. [A]	Max. [A]
0.33 - 1.5 (0.25 - 1.1)	6	6
2.0 (1.5)	6	10
3.0 (2.2)	6	16

You can use standard as well as quick-blow or slow-blow fuses.

- 3 x 200-240 V - 10 %/+ 10 %, 60 Hz, PE

Motor size [hp (kW)]	Minimum [A]	Maximum [A]
1.5 (1.1)	10	20
2.0 (1.5)	10	20
3.0 (2.2)	13	35

You can use standard as well as quick-blow or slow-blow fuses.

### 32.2 Leakage current, AC

- 3 x 440-480 V - 10 %/+ 10 %, 60 Hz, PE
- 3 x 200-240 V - 10 %/+ 10 %, 60 Hz, PE.

Speed [min <sup>-1</sup> ]	Power [hp] ([kW])	Power supply voltage [V]	Leakage current [mA]
1400-2000	0.33 - 2.0	≤ 400	< 3.5
1450-2200	(0.25 - 1.5)	> 400	< 5
2900-4000	0.33 - 3.0	≤ 400	< 3.5
	(0.25 - 2.2)	> 400	< 5
4000-5900	0.33 - 3.0	≤ 400	< 3.5
	(0.25 - 2.2)	> 400	< 5

The leakage currents are measured without any load on the shaft and in accordance with EN 61800-5-1:2007.

### 33. Inputs and outputs

#### Ground reference (GND)

All voltages refer to GND.

All currents return to GND.

#### Absolute maximum voltage and current limits

Exceeding the following electrical limits may result in severely reduced operating reliability and motor life:

Relay 1:

Maximum contact load: 250 VAC, 2 A or 30 VDC, 2 A.

Relay 2:

Maximum contact load: 30 VDC, 2 A.

GENI terminals: -5.5 to 9.0 VDC or less than 25 mADC.

Other input and output terminals: -0.5 to 26 VDC or less than 15 mADC.

#### Digital inputs, DI

Internal pull-up current greater than 10 mA at  $V_i$  equal to 0 VDC.

Internal pull-up to 5 VDC; current less for  $V_i$  greater than 5 VDC.

Certain low logic level:  $V_i$  less than 1.5 VDC.

Certain high logic level:  $V_i$  greater than 3.0 VDC.

Hysteresis: No.

Screened cable: 20-16 AWG (0.5 - 1.5 mm<sup>2</sup>).

Maximum cable length: 1640 ft (500 m)

#### Open-collector digital outputs, OC

Current sinking capability: 75 mADC, no current sourcing.

Load types: Resistive or/and inductive.

Low-state output voltage at 75 mADC: Maximum 1.2 VDC.

Low-state output voltage at 10 mADC: Maximum 0.6 VDC.

Overcurrent protection: Yes.

Screened cable: 20-16 AWG (0.5 - 1.5 mm<sup>2</sup>).

Maximum cable length: 1640 ft (500 m)

#### Analog inputs, AI

Voltage signal ranges:

- 0.5 - 3.5 VDC, AL AU.
- 0-5 VDC, AU.
- 0-10 VDC, AU.

Voltage signal:  $R_i$  greater than 100 k $\Omega$  at 77 °F (+25 °C).

Leak currents may occur at high operating temperatures.

Keep the source impedance low.

Current signal ranges:

- 0-20 mADC, AU.
- 4-20 mADC, AL AU.

Current signal:  $R_i$  is equal to 292  $\Omega$ .

Current overload protection: Yes. Change to voltage signal.

Measurement tolerance: - 0/+ 3 % of full scale (maximum-point coverage).

Screened cable: 20-16 AWG (0.5 - 1.5 mm<sup>2</sup>).

Maximum cable length: 1640 ft (500 m), excl. potentiometer.

Potentiometer connected to +5 V, GND, any AI:

Use maximum 10 k $\Omega$ .

Maximum cable length: 328 ft (100 m).

#### Analog output, AO

Current sourcing capability only.

Voltage signal:

- Range: 0-10 VDC.
- Minimum load between AO and GND: 1 k $\Omega$ .
- Short-circuit protection: Yes.

Current signal:

- Ranges: 0-20 and 4-20 mADC.
- Maximum load between AO and GND: 500  $\Omega$ .
- Open-circuit protection: Yes.

Tolerance: - 0/+ 4 % of full scale, maximum-point coverage.

Screened cable: 20-16 AWG (0.5 - 1.5 mm<sup>2</sup>).

Maximum cable length: 1640 ft (500 m)

#### Pt100/1000 inputs, PT

Temperature range:

- Minimum -50 °C. 80  $\Omega$  / 803  $\Omega$ .
- Maximum 204 °C. 177  $\Omega$  / 1773  $\Omega$ .

Measurement tolerance:  $\pm$  2.7 °F (1.5 °C).

Measurement resolution: less than 0.54 °F (0.3 °C).

Automatic range detection, Pt100 or Pt1000: Yes.

Sensor fault alarm: Yes.

Screened cable: 28-16 AWG (0.5 - 1.5 mm<sup>2</sup>).

Use Pt100 for short wires.

Use Pt1000 for long wires.

#### LiqTec sensor inputs

Use Grundfos LiqTec sensor only.

Screened cable: 28-16 AWG (0.5 - 1.5 mm<sup>2</sup>).

#### Grundfos Digital Sensor input and output, GDS\*

Use Grundfos Digital Sensor only.

\* Not applicable for TPE2, TPE2 D pumps. The built-in sensor for TPE3, TPE3 D pumps is connected to this input.

#### Power supplies

##### +5 V:

- Output voltage: 5 VDC - 5 %/+ 5 %.
- Maximum current: 50 mADC, sourcing only.
- Overload protection: Yes.

##### +24 V:

- Output voltage: 24 VDC - 5 %/+ 5 %.
- Maximum current: 60 mADC, sourcing only.
- Overload protection: Yes.

#### Digital outputs, relays

Potential-free changeover contacts.

Minimum contact load when in use: 5 VDC, 10 mA.

Screened cable: 28-12 AWG (0.5 - 2.5 mm<sup>2</sup>).

Maximum cable length: 1640 ft (500 m)

#### Bus input

Grundfos GENIbus protocol, RS-485.

Screened 3-core cable: 28-16 AWG (0.5 - 1.5 mm<sup>2</sup>).

Maximum cable length: 1640 ft (500 m)

### 34. Other technical data

#### EMC (electromagnetic compatibility)

Standard used: EN 61800-3.

The table below shows the emission category of the motor.

C1 fulfils the requirements for residential areas.

Motor size [hp] ([kW])	Emission category	
	1450-2000 min <sup>-1</sup>	2900-4000 min <sup>-1</sup> 4000-5900 min <sup>-1</sup>
0.33 (0.25)	C1	C1
0.50 (0.37)	C1	C1
0.74 (0.55)	C1	C1
1.0 (0.75)	C1	C1
1.5 (1.1)	C1	C1
2.0 (1.5)	C1	C1
3.0 (2.2)	C1	C1

#### Enclosure class

Standard: IP55 (IEC 34-5).

Optional: IP66 (IEC 34-5).

#### Insulation class

F (IEC 85).

#### Standby power consumption

5-10 W.

#### Cable entries

Motor size [hp] ([kW])	Number and size of cable entries
0.33 - 3.0 (0.25 - 2.2)	4 x M20

### 34.1 Torques

Terminal	Thread size	Max. torque [lbf-ft (Nm)]
L1, L2, L3, L, N	M4	1.73 (2.35)
NC, C1, C2, NO	M2.5	0.4 (0.5)
1 to 26 and A, Y, B	M2	0.4 (0.5)

### 34.2 Sound pressure level

Pump type	Sound pressure level ISO 3743 [dB(A)]
TPE2/TPE3 32-80	55
TPE2/TPE3 32-120	60
TPE2/TPE3 32-150	65
TPE2/TPE3 32-180	66
TPE2/TPE3 32-200	66
TPE2/TPE3 40-80	52
TPE2/TPE3 40-120	59
TPE2/TPE3 40-150	60
TPE2/TPE3 40-180	63
TPE2/TPE3 40-200	65
TPE2/TPE3 40-240	66
TPE2/TPE3 50-60	48
TPE2/TPE3 50-80	56
TPE2/TPE3 50-120	60
TPE2/TPE3 50-150	60
TPE2/TPE3 50-180	63
TPE2/TPE3 50-200	64
TPE2/TPE3 50-240	66
TPE2/TPE3 65-60	44
TPE2/TPE3 65-80	51
TPE2/TPE3 65-120	59
TPE2/TPE3 65-150	60
TPE2/TPE3 65-180	62
TPE2/TPE3 65-200	62
TPE2/TPE3 80-40	43
TPE2/TPE3 80-110	53
TPE2/TPE3 80-120	53
TPE2/TPE3 80-150	62
TPE2/TPE3 80-180	64
TPE2/TPE3 100-40	43
TPE2/TPE3 100-120	53
TPE2/TPE3 100-150	62
TPE2/TPE3 100-180	64

### 35. Factory settings

- Function is enabled.
- Function is disabled.
- Function is not available.

Settings	TPE3, TPE3 D	TPE2, TPE2 D	Function description on page
Setpoint	"Auto"	67 %	29
Operating mode	Normal	Normal	29
Control mode	"AUTO <sub>ADAPT</sub> "	Const. curve	30
Date and time	●	●	
"FLOW <sub>LIMIT</sub> "	○	-	
Automatic Night Setback	○	-	
Temperature influence	○	-	
"Buttons on product"	●	●	48
"Controller" ("Controller settings")			41
"T <sub>i</sub> "	1.0	0.5	
"K <sub>p</sub> "	8.0	0.5	
Operating range			43
"Min."	25 %	25 %	
"Max."	100 %	100 %	
"Ramps"	○	○	47
"Ramp-up"	1 second	1 second	
"Ramp-down"	3 seconds	3 seconds	
"Number" (Pump number)	1	1	48
"Radio communication"	●	●	48
"Analog input 1"	○	○	
"Analog input 2"	○	○	36
"Analog input 3"	○	○	
Built-in Grundfos sensor	●	-	37
"Grundfos differential pressure sensor"	"Feedback sensor"	-	
"Grundfos temperature sensor"*	○		
"Pt100/1000 input 1"	○/ Other function, liquid temperature*	○	38
"Pt100/1000 input 2"	○	○	
"Digital input 1"	○	○	
"Digital input 2"	○	○	38
"Digital in/output 3"	○	○	
"Digital in/output 4"	○	○	39
"Pulse flowmeter"	○	○	46
"Predefined setpoints"	○	○	45
Analog output	○	○	41
External setpoint function	○	○	43
"Signal relay 1"	○	○	
"Signal relay 2"	○	○	40
Limit 1 exceeded	○	○	46
Limit 2 exceeded	○	○	
"Standstill heating"	○	○	47
Motor bearing monitoring	○	○	47
"Pump name"	Grundfos	Grundfos	49
"Connection code"	-	-	49
"Unit configuration"	SI	SI	48

\* Some pumps are fitted with a Grundfos temperature sensor and some pumps are fitted with an external Pt100/1000 temperature sensor.

### 36. Disposing of the product

This product or parts of it must be disposed of in an environmentally sound way:

1. Use the public or private waste collection service.
2. If this is not possible, contact the nearest Grundfos company or service workshop.

Dispose of the waste battery through the national collective schemes. If in doubt, contact your local Grundfos company.



The crossed-out wheeie bin symbol on a product means that it must be disposed of separately from household waste. When a product marked with this symbol reaches its end of life, take it to a collection point designated by the local waste disposal authorities. The separate collection and recycling of such products will help protect the environment and human health.

## Appendix

## 1. Installation in the USA and Canada



In order to maintain hte cURus approval, follow these additional installation instructions. The UL approval is according to UL 1004-1.

### Outdoor installation

According to UL 778/C22.2 No 108-14, pumps intended for outdoor use must be marked enclosure type 3 and the product must be tested at a surface temperature down to -31 °F (-35 °C). The MLE enclosure is approved for type 3 or 4 and is rated at a surface temperature down to 32 °F (0 °C), thus it is only for indoor use in UL 778/C22.2 No 108-14 pump applications.

For more information about ambient temperature during operation, see section [11.4.2 Ambient temperature during operation](#).

### Canadian Interference-Causing Equipment Standard

This product complies with the Canadian ICES-003 Class B specifications. This Class B device meets all the requirements of the Canadian interference-causing equipment regulations.

### 1.1 Electrical codes

Cet appareil numérique de la Classe B est conforme à la norme NMB-003 du Canada. Cet appareil numérique de la Classe B respecte toutes les exigences du Règlement sur le matériel brouilleur du Canada. For USA

This product complies with the Canadian Electrical Code and the US National Electrical Code.

This product has been tested according to the national standards for Electronically Protected Motors:

CSA 22.2 100-14: 2014 (applies to Canada only).

UL 1004-1: 2015 (applies to USA only).

### Pour le Canada

#### Codes de l'électricité

Ce produit est conforme au Code canadien de l'électricité et au Code national de l'électricité américain.

Ce produit a été testé selon les normes nationales s'appliquant aux moteurs protégés électroniquement:

CSA 22.2 100.04: 2009 (s'applique au Canada uniquement).

UL 1004-1: Juin 2011 (s'applique aux États-Unis uniquement).

### 1.2 Radio communication

#### For USA

This device complies with part 15 of the FCC rules and RSS210 of IC rules.

Operation is subject to the following two conditions:

- This device may not cause interference.
- This device must accept any interference, including interference that may cause undesired operation of the device.

Users are cautioned that changes or modifications not expressly approved by Grundfos could void the user's authority to operate the equipment.

### Pour le Canada

#### Communication radio

Ce dispositif est conforme à la partie 15 des règles de la FCC et aux normes RSS210 de l'IC.

Son fonctionnement est soumis aux deux conditions suivantes:

- Ce dispositif ne doit pas provoquer de brouillage préjudiciable.
- Il doit accepter tout brouillage reçu, y compris le brouillage pouvant entraîner un mauvais fonctionnement.

### 1.3 Identification numbers

#### For USA

Grundfos Holding A/S

Contains FCC ID: OG3-RADIOM01-2G4.

#### For Canada

Grundfos Holding A/S

Model: RADIOMODULE 2G4

Contains IC: 10447A-RA2G4M01.

### Pour le Canada

#### Numéros d'identification

Grundfos Holding A/S

Modèle: RADIOMODULE 2G4

Contient IC: 10447A-RA2G4M01.

#### Location of identification numbers

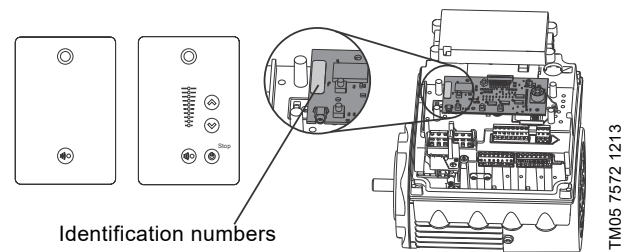

Fig. 1 Identification numbers

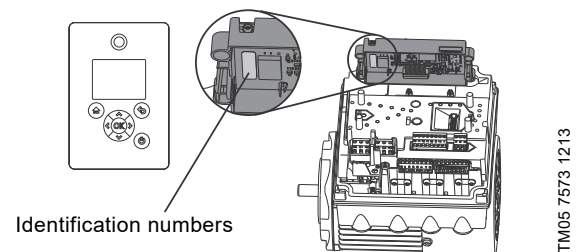

Fig. 2 Identification numbers

## 1.4 Electrical connection

### 1.4.1 Conductors

See section [9.2 Cable requirements](#).

### 1.4.2 Torques

Maximum tightening torques for the terminals can be found in section [34.1 Torques](#).

### 1.4.3 Line reactors

#### 1.4.4 Maximum line reactor size must not exceed 1.5 mH.

#### Short circuit current

If a short-circuit occurs, the pump can be used on a power supply delivering not more than 5000 RMS symmetrical amperes, 600 V maximum.

#### Fuses

Fuses used for motor protection must be rated for minimum 500 V.

Motors up to and including 3.0 hp (2.2 kW) require class K5 UR fuses.

#### Branch circuit protection

When the pump is protected by a circuit breaker, this must be rated for a maximum voltage of 480 V. The circuit breaker must be of the "inverse time" type.

#### Overload protection

Degree of overload protection provided internally by the drive, in percent of full-load current: 102 %.

## Appendix

**US:** Inlet pressure stated in bar relative pressure (pressure gauge value measured on the suction side of the pump)

**CA :** Pression d'entrée indiquée en bar de pression relative (valeur mesurée par le manomètre du côté aspiration de la pompe)

**MX:** Presión de succión en bares relativos (valor del manómetro en el lado de succión).

Pump type	p [psi (bar)]					
	68 °F (20 °C)	140 °F (60 °C)	194 °F (90 °C)	230 °F (110 °C)	248 °F (120 °C)	284 °F (140 °C)
TPE2 (D), TPE3 (D) 32-80	1.5 (0.1)	1.5 (0.1)	2.9 (0.2)	13.1 (0.9)	21.8 (1.5)	45 (3.1)
TPE2 (D), TPE3 (D) 32-120	1.5 (0.1)	1.5 (0.1)	2.9 (0.2)	13.1 (0.9)	21.8 (1.5)	45 (3.1)
TPE2 (D), TPE3 (D) 32-150	1.5 (0.1)	1.5 (0.1)	5.8 (0.4)	16 (1.1)	24.7 (1.7)	47.9 (3.3)
TPE2 (D), TPE3 (D) 32-180	1.5 (0.1)	2.9 (0.2)	8.7 (0.6)	18.9 (1.3)	27.6 (1.9)	50.8 (3.5)
TPE2 (D), TPE3 (D) 32-200	2.9 (0.2)	5.8 (0.4)	13.1 (0.9)	23.2 (1.6)	32 (2.2)	55.1 (3.8)
TPE2 (D), TPE3 (D) 40-80	1.5 (0.1)	1.5 (0.1)	2.9 (0.2)	13.1 (0.9)	21.8 (1.5)	45 (3.1)
TPE2 (D), TPE3 (D) 40-120	1.5 (0.1)	1.5 (0.1)	2.9 (0.2)	13.1 (0.9)	21.8 (1.5)	45 (3.1)
TPE2 (D), TPE3 (D) 40-150	1.5 (0.1)	1.5 (0.1)	7.3 (0.5)	17.4 (1.2)	26.1 (1.8)	49.3 (3.4)
TPE2 (D), TPE3 (D) 40-180	1.5 (0.1)	1.5 (0.1)	8.7 (0.6)	18.9 (1.3)	27.6 (1.9)	50.8 (3.5)
TPE2 (D), TPE3 (D) 40-200	1.5 (0.1)	2.9 (0.2)	10.2 (0.7)	20.3 (1.4)	29 (2.0)	52.2 (3.6)
TPE2 (D), TPE3 (D) 40-240	1.5 (0.1)	4.4 (0.3)	11.6 (0.8)	21.8 (1.5)	30.5 (2.1)	53.7 (3.7)
TPE2 (D), TPE3 (D) 50-60	1.5 (0.1)	1.5 (0.1)	7.3 (0.5)	17.4 (1.2)	26.1 (1.8)	49.3 (3.4)
TPE2 (D), TPE3 (D) 50-80	1.5 (0.1)	4.4 (0.3)	11.6 (0.8)	21.8 (1.5)	30.5 (2.1)	53.7 (3.7)
TPE2 (D), TPE3 (D) 50-120	5.8 (0.4)	8.7 (0.6)	16 (1.1)	26.1 (1.8)	34.8 (2.4)	58 (4.0)
TPE2 (D), TPE3 (D) 50-150	8.7 (0.6)	11.6 (0.8)	18.9 (1.3)	29 (2.0)	37.7 (2.6)	60.9 (4.2)
TPE2 (D), TPE3 (D) 50-180	10.2 (0.7)	13.1 (0.9)	20.3 (1.4)	30.5 (2.1)	39.2 (2.7)	62.4 (4.3)
TPE2 (D), TPE3 (D) 50-200	13.1 (0.9)	16 (1.1)	23.2 (1.6)	33.4 (2.3)	42.1 (2.9)	65.3 (4.5)
TPE2 (D), TPE3 (D) 50-240	13.1 (0.9)	16 (1.1)	23.2 (1.6)	33.4 (2.3)	42.1 (2.9)	65.3 (4.5)
TPE2 (D), TPE3 (D) 65-60	1.5 (0.1)	1.5 (0.1)	2.9 (0.2)	13.1 (0.9)	21.8 (1.5)	45 (3.1)
TPE2 (D), TPE3 (D) 65-80	1.5 (0.1)	1.5 (0.1)	4.4 (0.3)	16 (1.1)	24.7 (1.7)	47.9 (3.3)
TPE2 (D), TPE3 (D) 65-120	1.5 (0.1)	2.9 (0.2)	8.7 (0.6)	20.3 (1.4)	29 (2)	52.2 (3.6)
TPE2 (D), TPE3 (D) 65-150	1.5 (0.1)	2.9 (0.2)	10.2 (0.7)	21.8 (1.5)	30.5 (2.1)	53.7 (3.7)
TPE2 (D), TPE3 (D) 65-180	4.4 (0.3)	7.3 (0.5)	14.5 (1.0)	26.1 (1.8)	34.8 (2.4)	56.6 (3.9)
TPE2 (D), TPE3 (D) 65-200	8.7 (0.6)	11.6 (0.8)	18.9 (1.3)	30.5 (2.1)	39.2 (2.7)	60.9 (4.2)
TPE2 (D), TPE3 (D) 80-40	1.5 (0.1)	1.5 (0.1)	4.4 (0.3)	14.5 (1)	23.2 (1.6)	46.4 (3.2)
TPE2 (D), TPE3 (D) 80-110	1.5 (0.1)	4.4 (0.3)	13.1 (0.9)	21.8 (1.5)	30.5 (2.1)	53.7 (3.7)
TPE2 (D), TPE3 (D) 80-120	1.5 (0.1)	4.4 (0.3)	13.1 (0.9)	21.8 (1.5)	30.5 (2.1)	53.7 (3.7)
TPE2 (D), TPE3 (D) 80-150	1.5 (0.1)	4.4 (0.3)	13.1 (0.9)	21.8 (1.5)	30.5 (2.1)	53.7 (3.7)
TPE2 (D), TPE3 (D) 80-180	4.4 (0.3)	7.3 (0.5)	16 (1.1)	24.7 (1.7)	33.4 (2.3)	56.6 (3.9)
TPE2 (D), TPE3 (D) 100-40	1.5 (0.1)	1.5 (0.1)	5.8 (0.4)	16 (1.1)	24.7 (1.7)	45 (3.1)
TPE2 (D), TPE3 (D) 100-120	1.5 (0.1)	1.5 (0.1)	8.7 (0.6)	18.9 (1.3)	27.6 (1.9)	50.8 (3.5)
TPE2 (D), TPE3 (D) 100-150	1.5 (0.1)	2.9 (0.2)	10.2 (0.7)	20.3 (1.4)	29 (2)	52.2 (3.6)
TPE2 (D), TPE3 (D) 100-180	1.5 (0.1)	4.4 (0.3)	11.6 (0.8)	21.8 (1.5)	30.5 (2.1)	53.7 (3.7)

**GRUNDFOS Kansas City**

9300 Loiret Blvd.  
Lenexa, Kansas 66219  
Phone: (913) 227-3400  
Fax: (913) 227-3500

[www.grundfos.us](http://www.grundfos.us)

**Grundfos CBS Inc.**

902 Koomey Road  
Brookshire, TX 77423 USA  
Phone: 281-994-2700  
Toll Free: 1-800-955-5847  
Fax: 1-800-945-4777

[www.grundfosexpresssuite.com](http://www.grundfosexpresssuite.com)

**GRUNDFOS Canada**

2941 Brighton Road  
Oakville, Ontario L6H 6C9 Canada  
Phone: +1-905 829 9533  
Telefax: +1-905 829 9512

[www.grundfos.ca](http://www.grundfos.ca)

**GRUNDFOS México**

Boulevard TLC No. 15  
Parque Industrial Stiva Aeropuerto  
C.P. 66600 Apodaca, N.L. México  
Phone: 011-52-81-8144 4000  
Fax: 011-52-81-8144 4010

[www.grundfos.mx](http://www.grundfos.mx)

<b>98653472</b> 09.2020
ECM: 1293137

Trademarks displayed in this material, including but not limited to Grundfos, the Grundfos logo and "be think innovate" are registered trademarks owned by The Grundfos Group. All rights reserved. © 2020 Grundfos Holding A/S, all rights reserved.