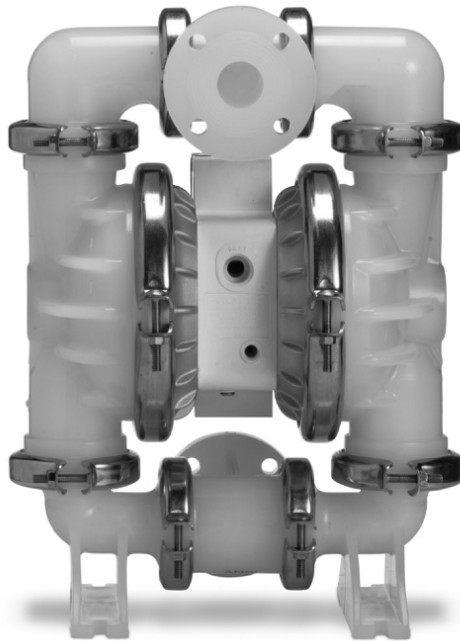


# EOM

ENGINEERING OPERATION  
& MAINTENANCE MANUAL

# PS4 Clamped Plastic Pump



Where Innovation Flows

---

**WILDEN®**

**Copyright**

Copyright 2018 PSG<sup>®</sup>, a Dover Company. All rights reserved.

PSG reserves the right to modify the information and illustrations in this document without prior notice. The product described in this document is furnished under a license agreement or nondisclosure agreement. No part of this document may be reproduced, stored in a retrieval system, or transmitted in any form or any means electronic or mechanical, including photocopying and recording, without the written permission of PSG, a Dover Company, except as described by the terms of those agreements.

This is a non-contractual document.

**Trademarks**

PSG and the PSG logo are registered trademarks of PSG. Wilden<sup>®</sup> is a registered trademark of PSG California LLC. Pro-Flo<sup>®</sup> SHIFT, Pro-Flo<sup>®</sup>, and Wil-Flex<sup>®</sup> are registered trademarks of PSG California LLC. Chem-Fuse<sup>™</sup>, Pure-Fuse<sup>™</sup>, Saniflex<sup>™</sup>, and Bunalast<sup>™</sup> are trademarks of PSG California LLC.

All trademarks, names, logos and service marks (collectively “trademarks”) in this document are registered and unregistered trademarks of their respective owners. Nothing contained in this document should be construed as granting any license or right to use any trademark without the prior written permission of the trademark owner.

**Warranty**

Each and every product manufactured by Wilden is built to meet the highest standards of quality. Every pump is functionally tested to ensure integrity of operation. Wilden warrants that pumps, accessories and parts manufactured or supplied by it to be free from defects in material and workmanship for a period of five (5) years from date of installation or six (6) years from date of manufacture, whichever comes first.

For more information, and to register your Wilden pump for warranty, please visit <https://www.psgdover.com/wilden/support/warranty-registration>.

**Certifications**

**CONTENTS**

**SECTION 1: Precautions – Read First! ..... 4**

**SECTION 2: Wilden Pump Designation System ..... 5**

**SECTION 3: How It Works ..... 6**

**SECTION 4: Dimensional Drawings ..... 7**

**SECTION 5: Performance ..... 8**

    PS4 Plastic Rubber-Fitted ..... 8

    PS4 Plastic EZ-Install TPE-Fitted ..... 8

    PS4 Plastic Full-Stroke PTFE-Fitted ..... 9

    Suction Lift Capability ..... 10

**SECTION 6: Suggested Installation, Operation, Maintenance, and Troubleshooting ..... 11**

**SECTION 7: Disassembly/Reassembly ..... 14**

    Pump Disassembly ..... 14

    Air Valve/Center Section Disassembly ..... 17

    Single-Point Exhaust ..... 20

    Reassembly Hints and Tips ..... 20


    Gasket Kit Installation ..... 22


**SECTION 8: Exploded View and Parts List ..... 23**


**SECTION 9: Elastomer Options ..... 25**

**SECTION 1**

**PRECAUTIONS – READ FIRST!**

 **WARNING:** Always wear safety glasses when operating a pump to avoid eye injury. If diaphragm rupture occurs, material being pumped may be forced out of the air exhaust.

 **CAUTION:** Do not apply compressed air to the exhaust port – pump will not function.


 **CAUTION:** Do not over-lubricate air supply– excess lubrication will reduce pump performance. Pump is pre-lubed.


 **TEMPERATURE LIMITS:**


Acetal	-29°C to 82°C	-20°F to 180°F
Buna-N	-12°C to 82°C	10°F to 180°F
Bunastal™	-40°C to 130°C	-40°F to 266°F
Geolast®	-40°C to 82°C	-40°F to 180°F
Neoprene	-18°C to 93°C	0°F to 200°F
Nordel™ EPDM	-51°C to 138°C	-60°F to 280°F
Nylon	-18°C to 93°C	0°F to 200°F
PFA	-7°C to 107°C	45°F to 225°F
Polypropylene	0°C to 79°C	32°F to 175°F
Polyurethane	-12°C to 66°C	10°F to 150°F
PVDF	-12°C to 107°C	10°F to 225°F
Saniflex	-29°C to 104°C	-20°F to 220°F
SIPD PTFE with EPDM-backed	4°C to 137°C	40°F to 280°F
SIPD PTFE with Neoprene-backed	4°C to 93°C	40°F to 200°F
PTFE*	4°C to 104°C	40°F to 220°F
FKM	-40°C to 177°C	-40°F to 350°F
Wil-Flex®	-40°C to 107°C	-40°F to 225°F


\*4°C to 149°C (40°F to 300°F) - 13 mm (1/2") and 25 mm (1") models only.


**NOTE:** Not all materials are available for all models. See "Wilden Pump Designation System" for material options for your pump.


 **CAUTION:** When choosing pump materials, be sure to check the temperature limits for all wetted components. Example: FKM has a maximum limit of 177°C (350°F), but polypropylene has a maximum limit of only 79°C (175°F).


 **CAUTION:** Maximum temperature limits are based on mechanical stress only. Certain chemicals will reduce maximum safe operating temperatures significantly. Consult the Chemical Resistance Guide for chemical compatibility and temperature limits.


 **WARNING:** Prevent sparking — If static sparking occurs, fire or explosion could result. Pump, valves and containers must be grounded to a proper grounding point when handling flammable fluids and whenever discharge of static electricity is a hazard.


 **CAUTION:** All Wilden pumps are capable of passing solids. Use a strainer on the pump intake to ensure that the pump's rated solids capacity is not exceeded.


 **CAUTION:** Do not exceed 8.6 bar (125 psig) air supply pressure.


 **CAUTION:** Do not exceed 82°C (180°F) air inlet temperature for all models.

 **CAUTION:** The process fluid and cleaning fluids must be compatible chemically with all wetted pump components.

 **CAUTION:** Before attempting any maintenance or repair, disconnect the compressed air line to the pump and allow all air pressure to bleed from the pump. Disconnect all intake, discharge, and air lines. Drain the pump by turning it upside down and allowing any fluid to flow into a suitable container. Be aware of any hazardous effects of contact with your process fluid.

 **CAUTION:** Thoroughly flush pumps before installing them into process lines. Clean and/or sanitize FDA- and USDA- approved pumps before using them.

 **CAUTION:** Before attaching the air line to the pump, blow out the air line for 10 to 20 seconds to make sure all pipeline debris is clear. Use an in-line air filter. A 5µ (micron) air filter is recommended.

 **CAUTION:** Pro-Flo pumps cannot be used in submersible applications. Pro-Flo SHIFT is available in both single-point exhaust (submersible) and standard (non-submersible) options. Do not use standard Pro-Flo SHIFT models in submersible applications.


 **CAUTION:** Before installation, tighten all hardware.

! **NOTE:** Materials of construction and elastomer material may influence suction lift parameters. Please refer to "Performance" for specifics.

! **NOTE:** When installing PTFE diaphragms, it is important to tighten outer pistons simultaneously (turning in opposite directions) to ensure tight fit. (See "Maximum Torque Specifications").

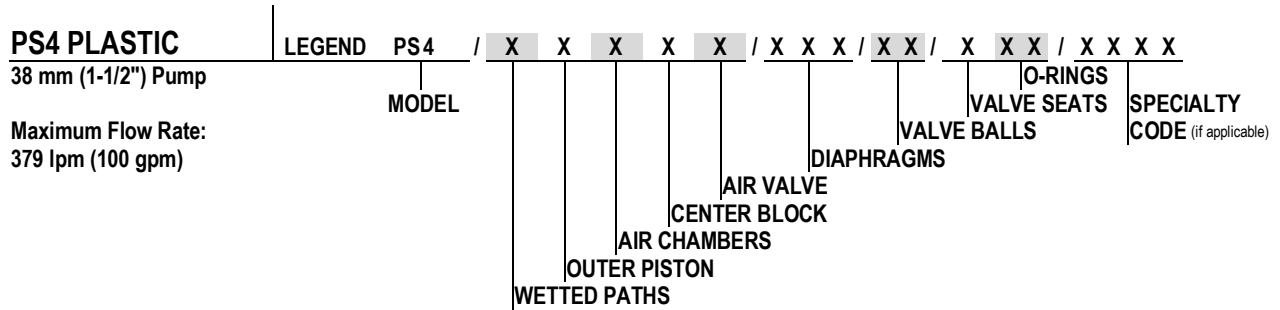
! **NOTE:** PVDF pumps come standard from the factory with expanded PTFE gaskets installed in the diaphragm bead of the liquid chamber, in the T-section and in the ball and seat area. PTFE gaskets cannot be re-used. Consult for installation instructions during reassembly.

! **NOTE:** In the event of a power failure, close the shut-off valve if you do not want the pump to restart when the power returns.

 **WARNING:** This product can expose you to chemicals including Nickel, Chromium, Cadmium, or Cobalt, which are known to the State of California to cause cancer and/or birth defects or other reproductive harm. For more information, go to [www.P65Warnings.ca.gov](http://www.P65Warnings.ca.gov).

**SECTION 2**

**WILDEN PUMP DESIGNATION SYSTEM**



**MATERIAL CODES**

<b>MODEL</b> PS4 = PRO-FLO® SHIFT	<b>AIR VALVE</b> A = ALUMINUM P = POLYPROPYLENE S = STAINLESS STEEL	<b>VALVE BALLS</b> BN = BUNA-N (RED DOT) EP = EPDM (BLUE DOT) FS = SANIFLEX™ [HYTREL® (CREAM)] FW = SANITARY WIL-FLEX®, IPD [SANTOPRENE® (TWO BLACK DOTS)] NE = NEOPRENE (GREEN DOT) PU = POLYURETHANE (BROWN) TF = PTFE (WHITE) VT = FKM (SILVER OR WHITE DOT) WF = WIL-FLEX® [SANTOPRENE® (THREE BLACK DOTS)]
<b>WETTED PATH</b> P = POLYPROPYLENE K = PVDF	<b>DIAPHRAGMS</b> BLL = BUNALAST™ IPD (BLACK) BNS = BUNA-N (RED DOT) EPS = EPDM (BLUE DOT) FWS = SANITARY WIL-FLEX®, EZ-INSTALL [SANTOPRENE® (TWO BLACK DOTS)] NES = NEOPRENE (GREEN DOT) SSL = FULL-STROKE SANIFLEX™ IPD [HYTREL® (CREAM)] TSS = FULL-STROKE PTFE W/SANIFLEX™ BACK-UP TWS = FULL-STROKE PTFE W/WIL-FLEX® BACK-UP VTS = FKM (WHITE DOT) WWL = WIL-FLEX® IPD [SANTOPRENE® (THREE BLACK DOTS)] ZGS = BUNALAST™, EZ-INSTALL (BLACK) ZPS = POLYURETHANE, EZ-INSTALL (CLEAR) ZSS = SANIFLEX™, EZ-INSTALL [HYTREL® (CREAM)] ZWS = WIL-FLEX®, EZ-INSTALL [SANTOPRENE® (THREE BLACK DOTS)]	<b>VALVE SEAT</b> P = POLYPROPYLENE K = PVDF
<b>OUTER PISTON</b> P = POLYPROPYLENE K = PVDF Z = NO OUTER PISTON		<b>VALVE SEAT O-RING</b> BN = BUNA-N PU = POLYURETHANE TV = PTFE-ENCAPSULATED FKM
<b>AIR CHAMBERS</b> A = ALUMINUM C = PFA-COATED ALUMINUM S = STAINLESS STEEL		
<b>CENTER BLOCK</b> A = ALUMINUM P = POLYPROPYLENE S = STAINLESS STEEL		

**SPECIALTY CODES**

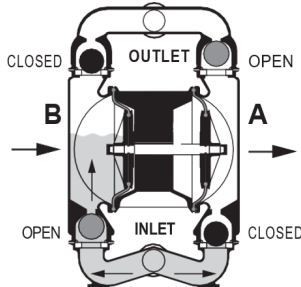
0100 Wil-Gard 110V	0320 Single-point exhaust
0102 Wil-Gard sensor wires ONLY	0502 PFA-coated hardware
0103 Wil-Gard 220V	0504 DIN flange
0206 PFA-coated hardware, Wil-Gard II™ sensor wires ONLY	0506 DIN flange, PFA-coated hardware

- ! **NOTE:** Most elastomeric materials use colored dots for identification
- ! **NOTE:** Not all models are available with all material options
- ! **NOTE:** ZGS diaphragm material previously known as Geolast® has been replaced by Bunalast™

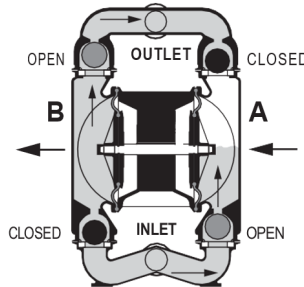
**SECTION 3**

**HOW IT WORKS – AIR-OPERATED DOUBLE-DIAPHRAGM PUMP**

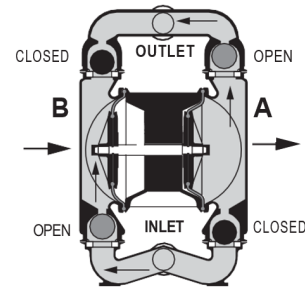
The Wilden diaphragm pump is an air-operated, positive displacement, self-priming pump. These drawings show flow pattern through the pump upon its initial stroke. It is assumed the pump has no fluid in it prior to its initial stroke.



**FIGURE 1** The air valve directs pressurized air to the back side of diaphragm A. The compressed air is applied directly to the liquid column separated by elastomeric diaphragms. The diaphragm acts as a separation membrane between the compressed air and liquid; a balanced load removes mechanical stress from the diaphragm. The compressed air moves the diaphragm away from the center of the pump. The opposite diaphragm is pulled in by the shaft connected to the pressurized diaphragm. Diaphragm B is on its suction stroke; air behind the diaphragm has been forced out to atmosphere through the exhaust port of the pump. The movement of diaphragm B toward the center of the pump creates a vacuum within chamber B. Atmospheric pressure forces fluid into the inlet manifold forcing the inlet valve ball off its seat. Liquid is free to move past the inlet valve ball and fill the liquid chamber (see shaded area).

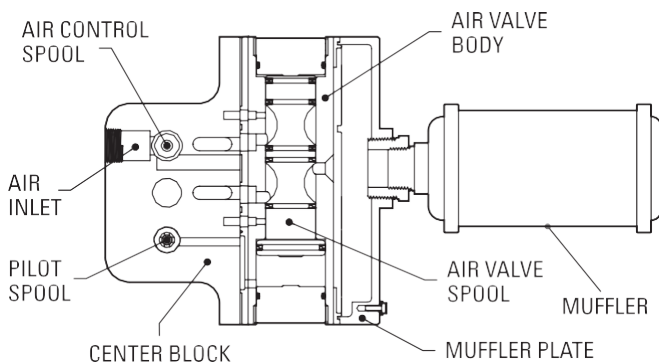


**FIGURE 2** When the pressurized diaphragm, diaphragm A, reaches the limit of its discharge stroke, the air valve redirects pressurized air to the back side of diaphragm B. The pressurized air forces diaphragm B away from the center while pulling diaphragm A to the center. Diaphragm B is now on its discharge stroke. Diaphragm B forces the inlet valve ball onto its seat due to the hydraulic forces developed in the liquid chamber and manifold of the pump. These same hydraulic forces lift the discharge valve ball off its seat, while the opposite discharge valve ball is forced onto its seat, forcing fluid to flow through the pump discharge. The movement of diaphragm A toward the center of the pump creates a vacuum within liquid chamber A. Atmospheric pressure forces fluid into the inlet manifold of the pump. The inlet valve ball is forced off its seat allowing the fluid being pumped to fill the liquid chamber.



**FIGURE 3** At completion of the stroke, the air valve again redirects air to the back side of diaphragm A, which starts diaphragm B on its exhaust stroke. As the pump reaches its original starting point, each diaphragm has gone through one exhaust and one discharge stroke. This constitutes one complete pumping cycle. The pump may take several cycles to completely prime depending on the conditions of the application.

**HOW IT WORKS – AIR DISTRIBUTION SYSTEM**

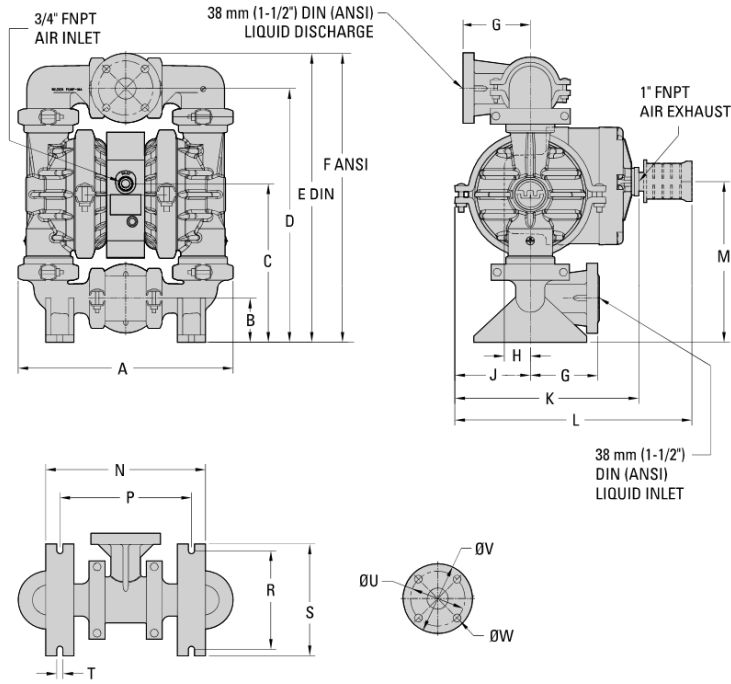


The heart of the patented Pro-Flo® SHIFT Air Distribution System (ADS) is the air valve assembly. The air valve design incorporates an unbalanced spool with the small end of the spool being pressurized continuously while the large end of the spool is alternately pressurized, then exhausted to move the spool. The air valve spool directs pressurized air to one chamber while exhausting the other. The air forces the main shaft/diaphragm assembly to move to one side – discharging liquid on that side and pulling liquid in on the other side. When the shaft reaches the end of the stroke, the inner piston actuates the pilot spool, which controls the air to the large end of the air valve spool. The repositioning of the air valve spool routes the air to the other air chamber. The air control spool allows air to flow freely into the air chamber for the majority of each pump stroke, but it significantly restricts the flow of air into the air chamber when activated by the inner piston near the end of each stroke.

**SECTION 4**

**DIMENSIONAL DRAWING**

**PS4 POLYPROPYLENE**

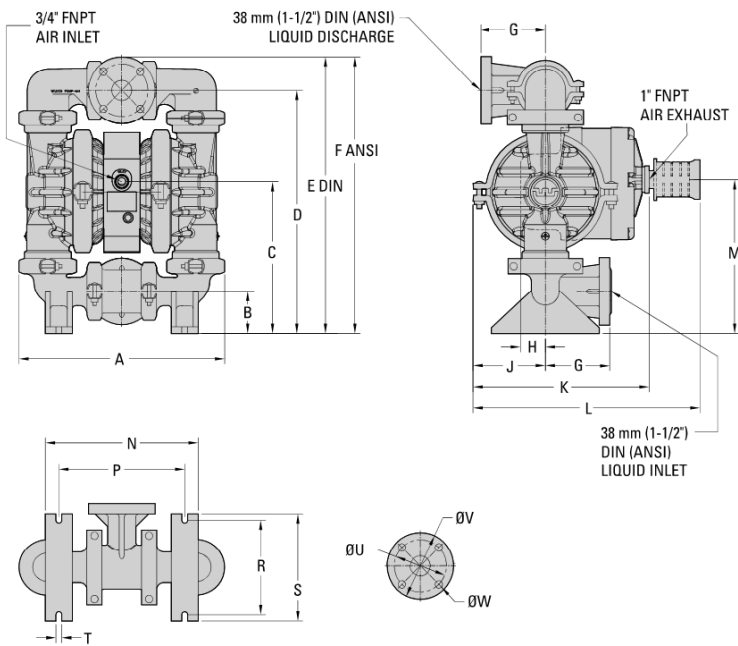


**DIMENSIONS**

ITEM	METRIC (mm)	STANDARD (inch)
A	394	15.5
B	79	3.1
C	304	12.0
D	465	18.3
E	532	21.0
F	528	20.8
G	122	4.8
H	48	1.9
J	137	5.4
K	331	13.0
L	444	17.5
M	286	11.2
N	287	11.3
P	236	9.3
R	180	7.1
S	204	8.0
T	10	0.4
<b>DIN FLANGE</b>		
U	110 DIA.	4.3 DIA.
V	150 DIA.	5.9 DIA.
W	18 DIA.	0.7 DIA.
<b>ANSI FLANGE</b>		
U	98 DIA.	3.9 DIA.
V	127 DIA.	5.0 DIA.
W	14 DIA.	0.6 DIA.

LW0212 REV. C

**PS4 PVDF**



**DIMENSIONS**

ITEM	METRIC (mm)	STANDARD (inch)
A	387	15.2
B	79	3.1
C	286	11.3
D	457	18.0
E	531	20.9
F	520	20.5
G	121	4.8
H	47	1.8
J	136	5.4
K	331	13.0
L	427	16.8
M	290	11.4
N	288	11.3
P	237	9.3
R	177	7.0
S	201	7.9
T	11	0.4
<b>DIN FLANGE</b>		
U	108 DIA.	4.3 DIA.
V	148 DIA.	5.8 DIA.
W	18 DIA.	0.7 DIA.
<b>ANSI FLANGE</b>		
U	98 DIA.	3.8 DIA.
V	125 DIA.	4.9 DIA.
W	14 DIA.	0.6 DIA.

LW0214 REV. C

**SECTION 5**

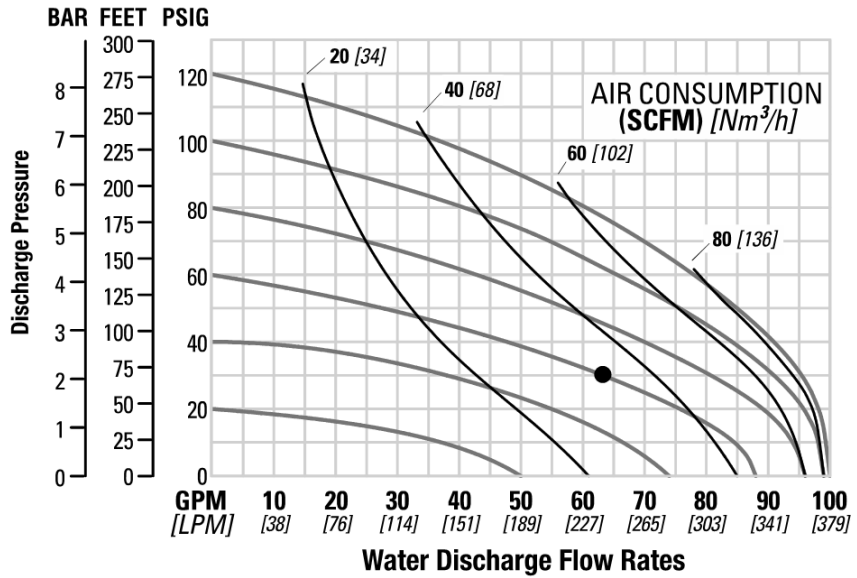
**PERFORMANCE**

**PS4 PLASTIC RUBBER-FITTED**

Ship Weight.....Polypropylene 18 kg (40 lb)  
PVDF 24 kg (52 lb)  
Air Inlet.....3/4"  
Inlet.....38 mm (1-1/2")  
Outlet.....38 mm (1-1/2")  
Suction Lift.....5.9 m Dry (19.5')  
8.3 m Wet (27.2')  
Disp. Per Stroke<sup>1</sup>.....1.0 L (0.26 gal)  
Max. Flow Rate.....379 lpm (100 gpm)  
Max. Size Solids.....4.8 mm (3/16")

<sup>1</sup>Displacement per stroke was calculated at 4.8 bar (70 psig) air inlet pressure against a 2.1 bar (30 psig) head pressure.

**Example:** To pump 238 lpm (63 gpm) against a discharge head of 2.1 bar (30 psig) requires 4.1 bar (60 psig) and 59 Nm<sup>3</sup>/h (35 scfm) air consumption.



Flow rates indicated on chart were determined by pumping water. For optimum life and performance, pumps should be specified so that daily operation parameters will fall in the center of the pump's performance curve.

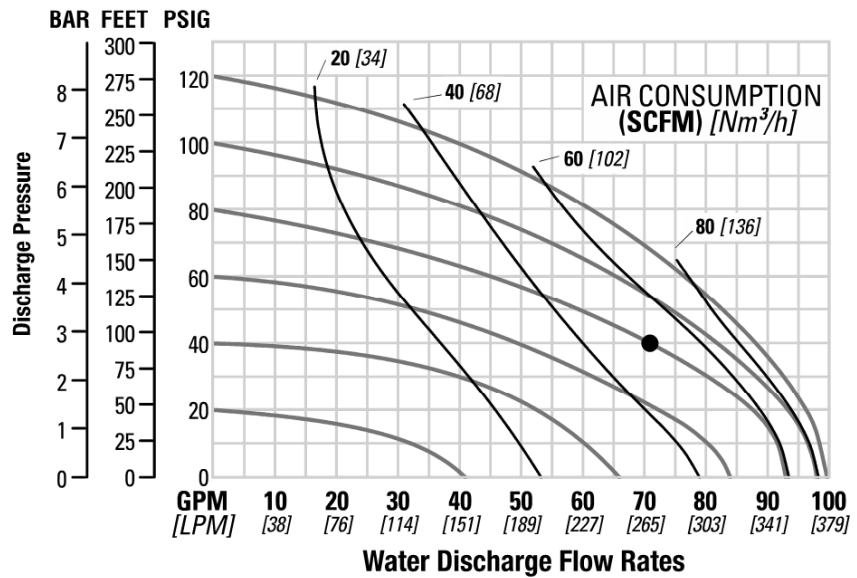
**Caution:** Do not exceed 8.6 bar (125 psig) air supply pressure.

**PS4 PLASTIC EZ-INSTALL TPE-FITTED**

Ship Weight.....Polypropylene 18 kg (40 lb)  
PVDF 24 kg (52 lb)  
Air Inlet.....3/4"  
Inlet.....38 mm (1-1/2")  
Outlet.....38 mm (1-1/2")  
Suction Lift.....6.2 m Dry (20.4')  
8.3 m Wet (27.2')  
Disp. Per Stroke<sup>1</sup>.....1.0 L (0.26 gal)  
Max. Flow Rate.....378 lpm (100 gpm)  
Max. Size Solids.....4.8 mm (3/16")

<sup>1</sup>Displacement per stroke was calculated at 4.8 bar (70 psig) air inlet pressure against a 2.1 bar (30 psig) head pressure.

**Example:** To pump 269 lpm (71 gpm) against a discharge head of 2.8 bar (40 psig) requires 5.5 bar (80 psig) and 88 Nm<sup>3</sup>/h (52 scfm) air consumption.



Flow rates indicated on chart were determined by pumping water. For optimum life and performance, pumps should be specified so that daily operation parameters will fall in the center of the pump's performance curve.

**Caution:** Do not exceed 8.6 bar (125 psig) air supply pressure.

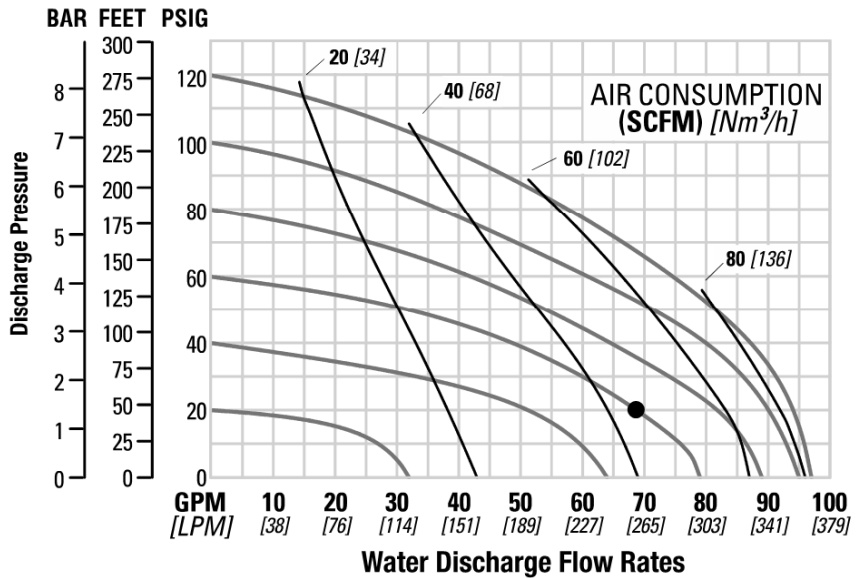
**PERFORMANCE**

**PS4 PLASTIC  
FULL-STROKE  
PTFE-FITTED**

Ship Weight.....Polypropylene 18 kg (40 lb)  
PVDF 24 kg (52 lb)  
Air Inlet.....3/4"  
Inlet.....38 mm (1-1/2")  
Outlet.....38 mm (1-1/2")  
Suction Lift.....6.1 m Dry (19.9')  
8.3 m Wet (27.2')  
Disp. Per Stroke<sup>1</sup>.....1.0 L (0.26 gal)  
Max. Flow Rate.....368 lpm (98 gpm)  
Max. Size Solids.....4.8 mm (3/16")

<sup>1</sup>Displacement per stroke was calculated at 4.8 bar (70 psig) air inlet pressure against a 2.1 bar (30 psig) head pressure.

**Example:** To pump 257 lpm (68 gpm) against a discharge head of 1.4 bar (20 psig) requires 4.1 bar (60 psig) and 73 Nm<sup>3</sup>/h (43 scfm) air consumption.



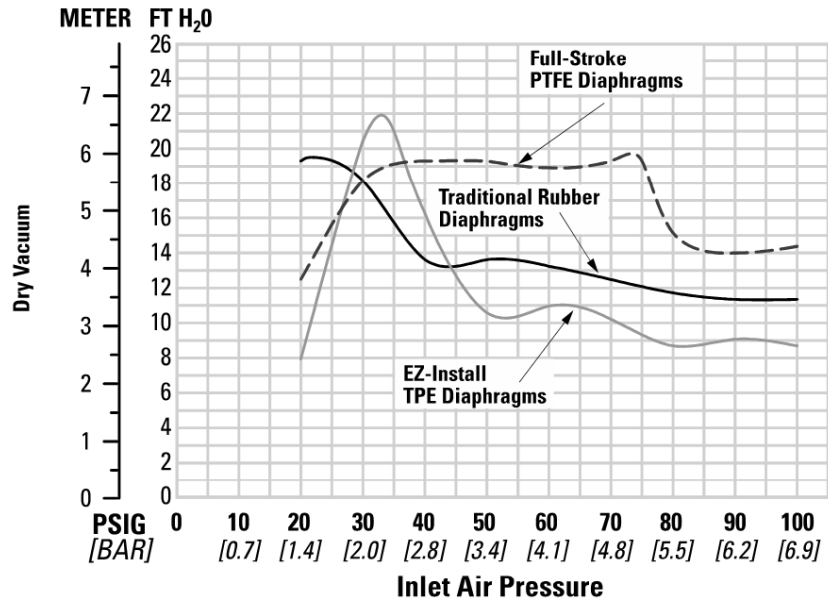
Flow rates indicated on chart were determined by pumping water. For optimum life and performance, pumps should be specified so that daily operation parameters will fall in the center of the pump's performance curve.

**Caution:** Do not exceed 8.6 bar (125 psig) air supply pressure.

**SUCTION LIFT CAPABILITY**

**PS4 PLASTIC  
SUCTION LIFT  
CAPABILITY**

Suction-lift curves are calibrated for pumps operating at 305 m (1,000') above sea level. This chart is meant to be a guide only. There are many variables that can affect your pump's operating characteristics. The number of intake and discharge elbows, viscosity of pumping fluid, elevation (atmospheric pressure) and pipe friction loss all affect the amount of suction lift your pump will attain.



**SECTION 6**

**SUGGESTED INSTALLATION, OPERATION, MAINTENANCE AND TROUBLESHOOTING**

Wilden pumps are designed to meet the performance requirements of even the most demanding pumping applications. They have been designed and manufactured to the highest standards and are available in a variety of liquid path materials to meet your chemical resistance needs. Refer to "Performance" for an in-depth analysis of the performance characteristics of your pump. Wilden offers the widest variety of elastomer options in the industry to satisfy temperature, chemical compatibility, abrasion resistance and flex concerns.

The suction pipe size should be at least equal to or larger than the diameter size of the suction inlet on your Wilden pump. The suction hose must be a non-collapsible, reinforced type because these pumps are capable of pulling a high vacuum. Discharge piping should also be equal to or larger than the diameter of the pump discharge, which will help reduce friction losses.

**CAUTION:** All fittings and connections must be airtight. Otherwise, pump suction capability will be reduced or lost.

Months of careful planning, study and selection efforts can result in unsatisfactory pump performance if installation details are left to chance. You can avoid premature failure and long-term dissatisfaction by exercising reasonable care throughout the installation process.

**Location**

Noise, safety and other logistical factors usually dictate where equipment will be situated on the production floor. Multiple installations with conflicting requirements can result in congestion of utility areas, leaving few choices for additional pumps. Within the framework of these and other existing conditions, locate every pump in such a way that the following six key factors are balanced against each other to maximum advantage:

- **Access:** First, the location should be accessible. If it's easy to reach the pump, maintenance personnel will be able to perform routine inspections and adjustments more easily. If major repairs become necessary, ease of access can play a key role in speeding the repair process and reducing total downtime.
- **Air Supply:** Every pump location should have an air line large enough to supply the volume of air necessary to achieve the desired pumping rate. For best results, the pumps should use a 5µ (micron) air filter, needle valve and regulator. The use of an air filter before the pump will ensure that the majority of any pipeline contaminants will be eliminated.
- **Solenoid Operation:** When operation is controlled by a solenoid valve in the air line, three-way valves should be used. This valve allows trapped air between the valve and the pump to bleed off, which improves pump performance. You can estimate pumping volume by counting the number of strokes per minute, and then multiplying that figure by the displacement per stroke.
- **Muffler:** Using the standard Wilden muffler, sound levels are reduced below OSHA specifications. You can use other mufflers to reduce sound levels farther, but they usually reduce pump performance.
- **Elevation:** Selecting a site that is well within the pump's dynamic lift capability will assure that loss-of-prime issues will

be eliminated. In addition, pump efficiency can be adversely affected if proper attention is not given to site location.

- **Piping:** Final determination of the pump site should not be made until the piping challenges of each possible location have been evaluated. The impact of current and future installations should be considered ahead of time to make sure that inadvertent restrictions are not created for any remaining sites.

The best choice possible will be a site involving the shortest and straightest hook-up of suction and discharge piping. Unnecessary elbows, bends and fittings should be avoided. Pipe sizes should be selected to keep friction losses within practical limits. All piping should be supported independently of the pump. In addition, the piping should be aligned to avoid placing stress on the pump fittings.

Flexible hose can be installed to aid in absorbing the forces created by the natural reciprocating action of the pump. If the pump is to be bolted down to a solid location, a mounting pad placed between the pump and the foundation will assist in minimizing pump vibration. Flexible connections between the pump and rigid piping will also assist in minimizing pump vibration. If quick-closing valves are installed at any point in the discharge system, or if pulsation within a system becomes a problem, a surge suppressor (SD Equalizer) should be installed to protect the pump, piping and gauges from surges and water hammer.

If the pump is to be used in a self-priming application, make sure that all connections are airtight and that the suction lift is within the model's ability.

**NOTE:** Materials of construction and elastomer material have an effect on suction lift parameters. Please refer to "Performance" for specifics.

When pumps are installed in applications involving flooded suction or suction head pressures, a gate valve should be installed in the suction line to permit closing of the line for pump service.

Pumps in service with a positive suction head are most efficient when inlet pressure is limited to 0.5–0.7 bar (7–10 psig). Premature diaphragm failure may occur if positive suction is 0.7 bar (10 psig) and higher.

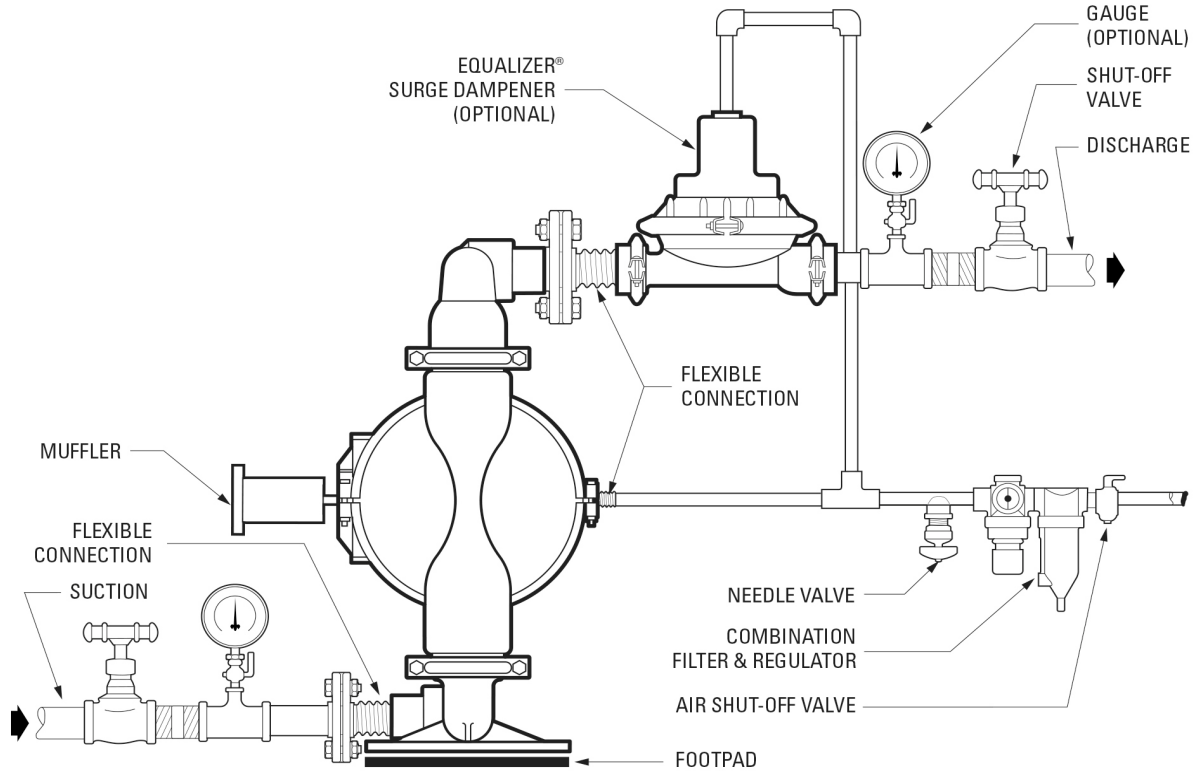
**Single-Point Exhaust**

Pro-Flo SHIFT pumps can be used for submersible applications when using the Pro-Flo SHIFT's single-point exhaust.

**CAUTION:** All Wilden pumps are capable of passing solids. Use a strainer on the pump intake to ensure that the pump's rated solids capacity is not exceeded.

**CAUTION:** Do not exceed 8.6 bar (125 psig) air supply pressure.

**SUGGESTED INSTALLATION, OPERATION, MAINTENANCE AND TROUBLESHOOTING**



**!** **NOTE:** In the event of a power failure, close the shut-off valve if you do not want the pump to restart when the power returns.

**Air-Operated Pumps:** To stop the pump from operating in an emergency, simply close the shut-off valve (user-supplied) installed in the air supply line. A properly functioning valve will stop the air supply to the pump, therefore stopping output. This shut-off valve should be located far enough away from the pumping equipment such that it can be reached safely in an emergency.

**Operation**

The Pro-Flo SHIFTS pumps are pre-lubricated and do not require in-line lubrication. Additional lubrication will not damage the pump. However, if the pump is heavily lubricated by an external source, the pump's internal lubrication maybe washed away. If the pump is then moved to a nonlubricated location, it may need to be disassembled and re-lubricated as described in "Disassembly/ Reassembly".

Pump discharge rate can be controlled by limiting the volume and/or pressure of the air supply to the pump. An air regulator is used to regulate air pressure. A needle valve is used to regulate volume. Pump discharge rate also can be controlled by throttling the pump discharge by partially closing a valve in the discharge line of the pump. This action increases friction loss, which reduces flow rate. (See "Performance") This is useful when the need exists

to control the pump from a remote location. When the pump discharge pressure equals or exceeds the air supply pressure, the pump will stop. No bypass or pressure relief valve is needed, and pump damage will not occur. The pump has reached a "deadhead" situation and can be restarted by reducing the fluid discharge pressure or increasing the air inlet pressure. Wilden Pro-Flo SHIFTS pumps run solely on compressed air and do not generate heat. Therefore, your process fluid temperature will not be affected.

**Maintenance and Inspections**

Because each application is unique, maintenance schedules maybe different for every pump. Frequency of use, line pressure, viscosity and abrasiveness of process fluid all affect the parts life of a Wilden pump. Periodic inspections have been found to offer the best means for preventing unscheduled pump downtime. Personnel familiar with the pump's construction and service should be informed of any abnormalities that are detected during operation.

## **SUGGESTED INSTALLATION, OPERATION, MAINTENANCE AND TROUBLESHOOTING**

### **Troubleshooting**

#### ***Pump will not run or runs slowly.***

1. Remove plug from pilot spool exhaust.
2. Ensure that the air inlet pressure is at least 0.4 bar (5 psig) above startup pressure and that the differential pressure (the difference between air inlet and liquid discharge pressures) is not less than 0.7 bar (10 psig).
3. Check air inlet filter for debris (see "Suggested Installation, Operation, Maintenance and Troubleshooting").
4. Check for extreme air leakage (blow by) that would indicate worn seals/bores in the air valve, pilot spool and main shaft.
5. Disassemble the pump and check for obstructions in the air passageways or objects that would obstruct the movement of internal parts.
6. Check for sticking ball check valves.
  - a. If material being pumped is not compatible with pump elastomers, swelling may occur. Replace ball check valves and seals with proper elastomers.
  - b. Also, as the check valve balls wear out, they become smaller and can become stuck in the seats. In this case, replace balls and seats.
7. Check for any broken inner piston that would cause the air valve spool to be unable to shift.

#### ***Pump runs, but little or no product flows.***

1. Check for pump cavitation. Slow pump speed down to allow thick material to flow into liquid chambers.
2. Verify that vacuum required to lift liquid is not greater than the vapor pressure of the material being pumped (cavitation).
3. Check for sticking ball check valves.
  - a. If material being pumped is not compatible with pump elastomers, swelling may occur. Replace ball check valves and seals with proper elastomers.
  - b. Also, as the check valve balls wear out, they become smaller and can become stuck in the seats. In this case, replace balls and seats.

#### ***Pump air valve freezes.***

1. Check for excessive moisture in the compressed air.
  - a. Either install a dryer or a hot air generator for compressed air.
  - b. Alternatively, you may use coalescing filter to remove the water from the compressed air in some applications.

#### ***Air bubbles in pump discharge.***

1. Check for a ruptured diaphragm.
2. Check tightness of outer pistons (see "Disassembly/Reassembly").
3. Check tightness of fasteners and integrity of O-rings and seals, especially at intake manifold.
4. Ensure pipe connections are airtight.

#### ***Product comes out air exhaust.***

1. Check for a diaphragm rupture.
2. Check the tightness of the outer pistons to the shaft.

**SECTION 7**

**DISASSEMBLY / REASSEMBLY**

**PUMP DISASSEMBLY**

**Tools Required:**

- 1/2" Socket Wrench
- 1-5/16" Socket Wrench
- Adjustable Wrench
- Vise equipped with soft jaws (such as plywood, plastic or other suitable material)



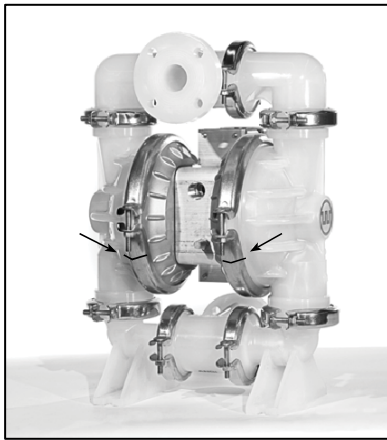
**CAUTION:** Before attempting any maintenance or repair, disconnect the compressed air line to the pump and allow all air pressure to bleed from the pump. Disconnect all intake, discharge, and air lines. Drain the pump by turning it upside down and allowing any fluid to flow into a suitable container. Be aware of any hazardous effects of contact with your process fluid.



**NOTE:** Your specific pump model may vary from the configuration shown; however, pump disassembly procedure will be the same.

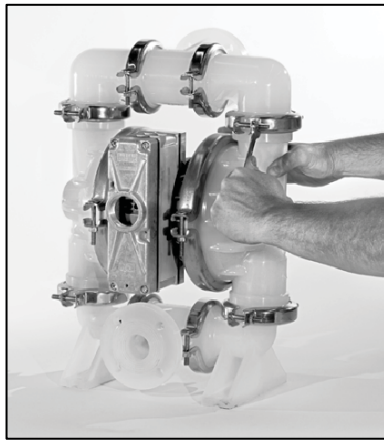


**NOTE:** Replace worn parts with genuine Wilden parts for reliable performance.



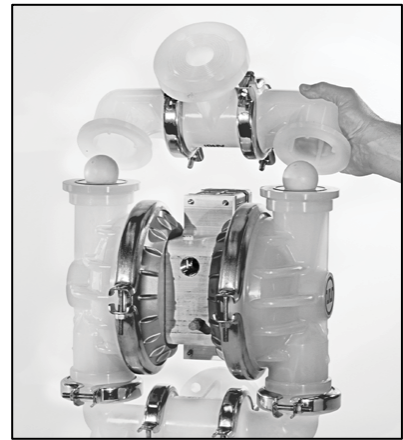
**Step 1**

Before starting disassembly, mark a line from each liquid chamber to its corresponding air chamber. This line will assist in proper alignment during reassembly.



**Step 2**

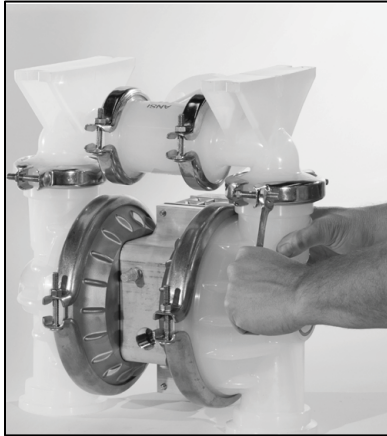
Using an appropriate-sized wrench, remove the two small clamp bands that fasten the discharge manifold to the liquid chambers.



**Step 3**

Remove the discharge manifold and inspect the ball cage area of manifold for wear or damage. Remove the discharge valve balls and valve seats from the liquid chambers, and inspect for nicks, gouges, chemical attack or abrasive wear. Replace worn parts with genuine Wilden parts for reliable performance.

**DISASSEMBLY / REASSEMBLY**



**Step 4**

Using an appropriate-sized wrench, remove the two small clamp bands that fasten the inlet manifold to the liquid chambers.

**NOTE:** Inverting the pump will facilitate removal of the inlet manifold.



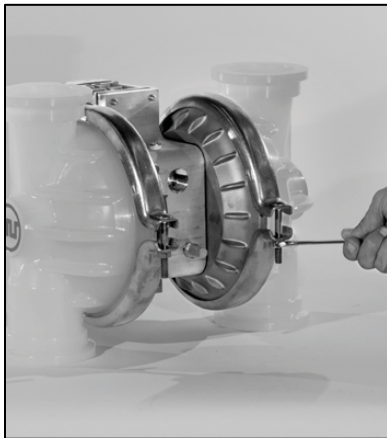
**Step 5**

Remove the inlet manifold and inspect the ball cage area of manifold for wear or damage. Remove the inlet valve balls and valve seats from the liquid chambers, and inspect for nicks, gouges, chemical attack or abrasive wear. Replace worn parts with genuine Wilden parts for reliable performance.



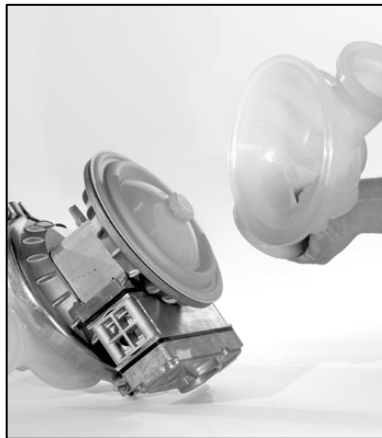
**Step 6**

Remove small manifold clamp bands on inlet and discharge to inspect manifold O-rings. Replace worn parts with genuine Wilden parts for reliable performance.



**Step 7**

Remove one set of large clamp bands which secure one liquid chamber to the center section.



**Step 8**

Lift liquid chamber away from center section to expose diaphragm and outer piston.



**Step 9**

Using an adjustable wrench remove the diaphragm assembly.



Figure 10a



Figure 10b

**Step 10**

**NOTE:** Due to varying torque values, one of the following two situations may occur:

1) The outer piston, diaphragm and inner piston remain attached to the shaft and the entire assembly can be removed from the center section (Figure 10a).

2) The outer piston, diaphragm and inner piston separate from the shaft which remains connected to the opposite side diaphragm assembly (Figure 10b). Repeat disassembly instructions for the opposite liquid chamber. Inspect diaphragm assembly and shaft for signs of wear or chemical attack. Replace all worn parts with genuine Wilden parts for reliable performance.



**Step 11**

To remove diaphragm assembly from shaft, secure shaft with soft jaws (a vise fitted with plywood or other suitable material) to ensure shaft is not nicked, scratched or gouged. Using an adjustable wrench, remove diaphragm assembly from shaft.

**DISASSEMBLY / REASSEMBLY**

**AIR VALVE / CENTER SECTION DISASSEMBLY**

**Tools Required:**

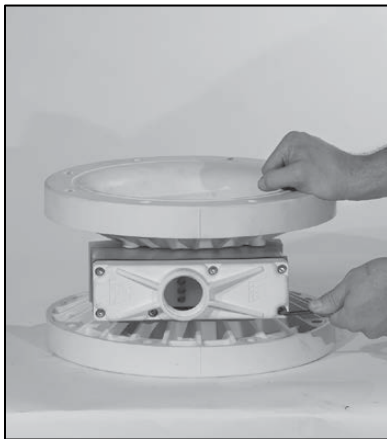
- 3/16" Hex-Head Wrench
- 1/4" Hex-Head Wrench
- Snap-Ring Pliers
- O-Ring Pick



**CAUTION:** Before attempting any maintenance or repair, disconnect the compressed air line to the pump and allow all air pressure to bleed from the pump. Disconnect all intake, discharge, and air lines. Drain the pump by turning it upside down and allowing any fluid to flow into a suitable container. Be aware of any hazardous effects of contact with your process fluid.

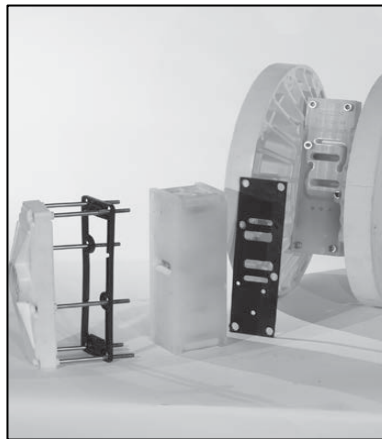


**NOTE:** Replace worn parts with genuine Wilden parts for reliable performance.



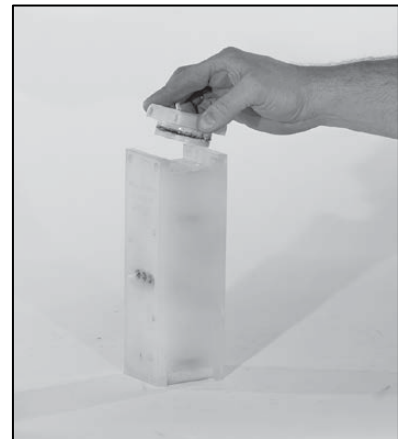
**Step 1**

Loosen the air valve bolts using an appropriate-sized hex wrench.



**Step 2**

Remove air valve bolts, muffer plate and air valve assembly to expose muffer gasket and air valve gasket. Replace if necessary.



**Step 3**

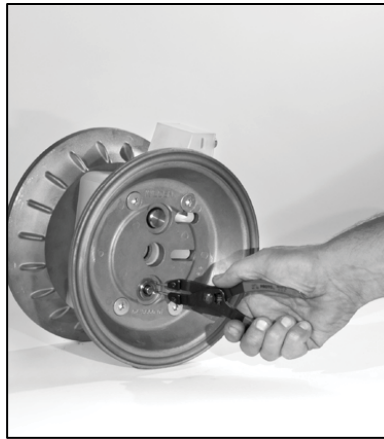
Remove air valve end cap to expose the large end of the air valve spool by lifting up on the air valve end cap once the bolts have been removed.

**DISASSEMBLY / REASSEMBLY**



**Step 4**

Remove air valve spool from air valve body by threading one air valve bolt into the end of the spool and gently slide the spool out of the air valve body. Inspect seals for signs of wear and replace entire assembly, if necessary. Use caution when handling the air valve spool to prevent damaging seals. **NOTE:** Seals should not be removed from assembly. Seals are not sold separately.



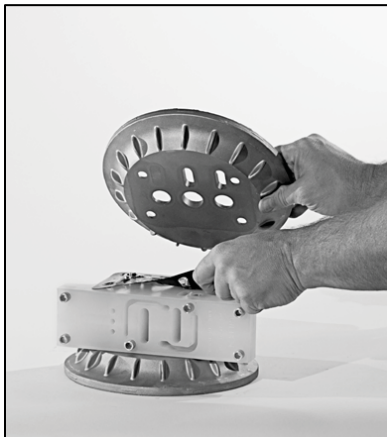
**Step 5**

Remove pilot spool retaining snap ring on both sides of the center section using snap-ring pliers.



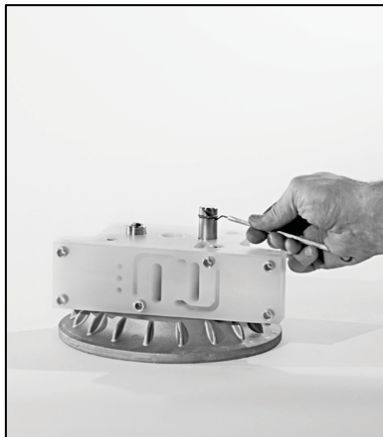
**Step 6**

Remove the air chamber bolts using an appropriate-sized hex wrench.



**Step 7**

Remove the air chamber and inspect the air chamber gaskets (2). Replace if necessary.



**Step 8**

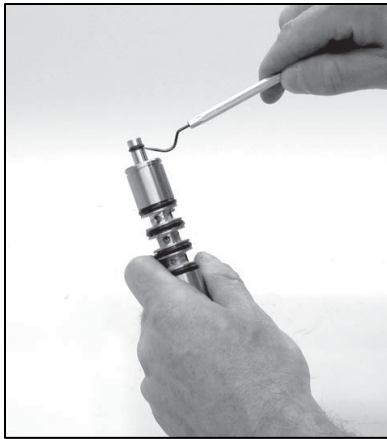
With an O-ring pick, remove the O-ring from the modulator spool.



**Step 9**

Remove the pilot spool from the center section.

**DISASSEMBLY / REASSEMBLY**



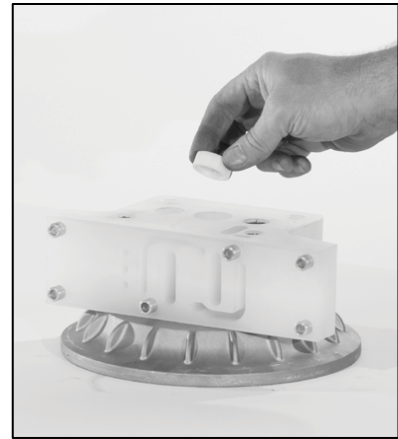
**Step 10**

Using an O-ring pick, gently remove the O-ring from the opposite side of the dimpled-end of the pilot spool. Check for nicks, gouges or other signs of wear; replace pilot spool assembly if necessary.



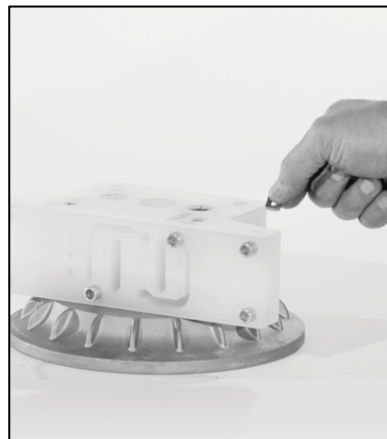
**Step 11**

Remove modulator spool from center section. Check for wear to spool or O-ring and replace if necessary.



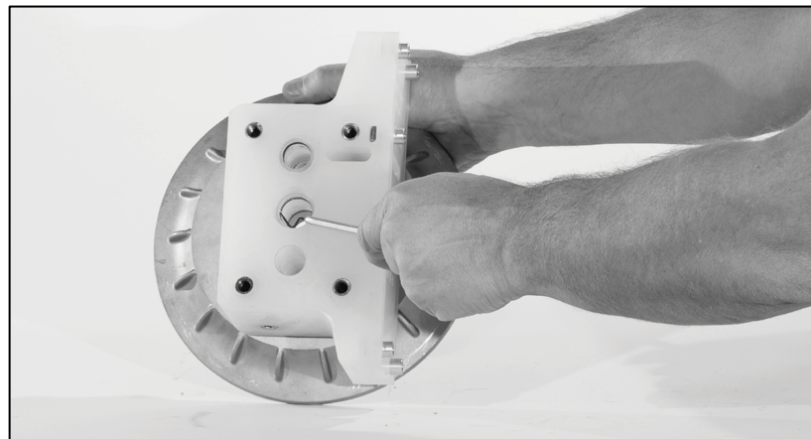
**Step 12**

Remove and inspect the shaft bushings (2). Replace if necessary.



**Step 13**

Once the air chambers have been removed, the square air valve nuts (6) may be removed or replaced if necessary.

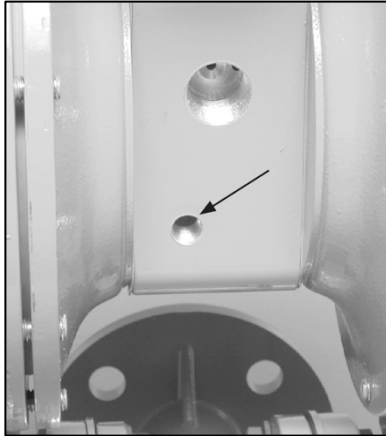


**Step 14**

Inspect the center block Glyd™ rings (2) for wear. If replacement is necessary, use an O-ring pick to remove the used Glyd™ rings then replace with genuine Wilden replacement parts.

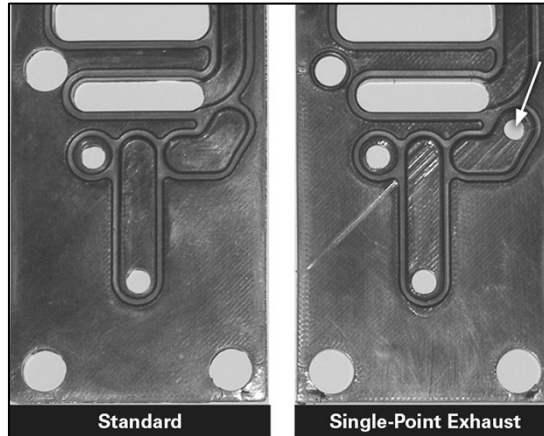
**DISASSEMBLY / REASSEMBLY**

**SINGLE-POINT EXHAUST**



**Step 1**

Remove the pilot exhaust muffler in the pilot bleed port located at the front of the center block. Install 1/4" NPT pipe plug (00-7010-08) into the bleed port.



**Step 2**

**Optional:** Install a single-point exhaust gasket (04-2638-52). The single-point air valve gasket can be purchased as a spare part or included with the purchase of a new Pro-Flo SHIFT pump.

**REASSEMBLY HINTS AND TIPS**

Upon performing applicable maintenance to the air distribution system, the pump can now be reassembled. Please refer to the disassembly instructions for photos and parts placement.

To reassemble the pump, follow the disassembly instructions in reverse order. The air distribution system needs to be assembled first, then the diaphragms and finally the wetted path. The applicable torque specifications are on this page.

The following tips will assist in the assembly process:

- Lubricate the air valve bore, center section shaft and pilot spool bore with NLGI grade 2 white EP bearing grease or equivalent.
- Clean the inside of the center section shaft bore to ensure no damage is done to new shaft seals.
- A small amount of NLGI grade 2 white EP bearing grease can be applied to the muffler and air valve gaskets to lubricate gaskets during assembly.
- Make sure that the exhaust port on the muffler plate is centered between the two exhaust ports on the center section.
- Stainless bolts should be lubed to reduce the possibility of seizing during tightening.

**Maximum Torque Specifications**

Description	Torque
Air Valve	5.1 N·m (45 in-lb)
Outer Pistons	47.5 N·m (35 ft-lb)
Small Clamp Bands	9.6 N·m (85 ft-lb)
Large Clamp Bands	18.6 N·m (165 ft-lb)
Air Chamber Screws	47.5 N·m (35 ft-lb)

## DISASSEMBLY / REASSEMBLY

### SHAFT SEAL INSTALLATION

#### Pre-Installation

After all the old seals have been removed, the inside of the bushing should be cleaned to ensure no debris is left that may cause premature damage to the new seals.

#### Installation

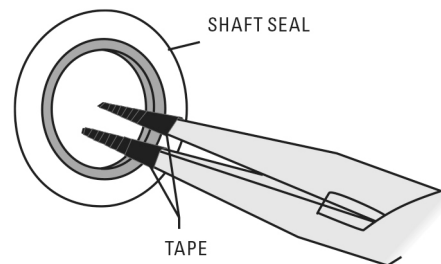
1. To prevent damaging the inside surface of the new seal, wrap electrical tape around each leg of the needle-nose pliers. (Heat shrink tubing may also be used.)
2. With a new seal in hand, place the two legs of the needle-nose pliers inside the seal ring. (See Figure A.)
3. Open the pliers as wide as the seal diameter will allow, then with two fingers pull down on the top portion of the seal to form a kidney bean shape. (See Figure B.)
4. Lightly clamp the pliers together to hold the seal into the kidney shape. Be sure to pull the seal into as tight of a kidney shape as possible. This will allow the seal to travel down the bushing bore with greater ease.
5. With the seal clamped in the pliers, insert the seal into the bushing bore and position the bottom of the seal into the correct groove. When the bottom of the seal is seated in the groove, release the clamp pressure on the pliers. This will allow the seal to partially snap back to its original shape.
6. After removing the pliers, you will notice a slight bump in the seal shape. Before the seal can be resized properly, the bump in the seal should be removed as much as possible. This can be done with either a Phillips screwdriver or your finger. With the side of the screwdriver or your finger, apply light pressure to the peak of the bump. This pressure will cause the bump to be eliminated almost completely.
7. Lubricate the edge of the shaft with NLGI grade 2 white EP bearing grease.
8. Slowly insert the center shaft with a rotating motion. This will complete the resizing of the seal.
9. Repeat these steps for the remaining seals.

#### Tools

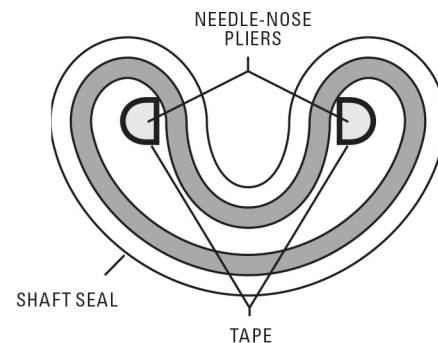
The following tools can be used to aid in the installation of the new seals:

- Needle-Nose Pliers
- Phillips Screwdriver
- Electrical Tape

**Figure A**

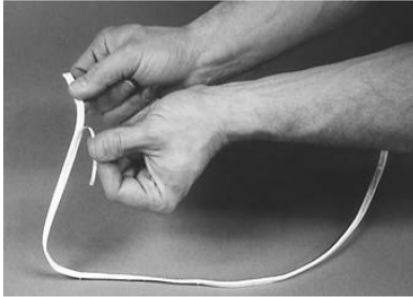


**Figure B**



## GASKET KIT INSTALLATION (04-9503-99)

Carefully prepare sealing surfaces by removing all debris and foreign matter from diaphragm bead and all mating surfaces. If necessary, smooth or deburr all sealing surfaces. Mating surfaces must be properly aligned in order to ensure positive sealing characteristics.



### **Step 1**

Gently remove the adhesive covering from the back of the PTFE tape. Ensure that the adhesive strip remains attached to the PTFE tape.



### **Step 2**

Starting at any point, place the PTFE tape in the center of the diaphragm bead groove on the liquid chamber and press lightly on the tape to ensure that the adhesive holds in place during assembly. Do not stretch the tape during placement in the center of diaphragm bead groove.



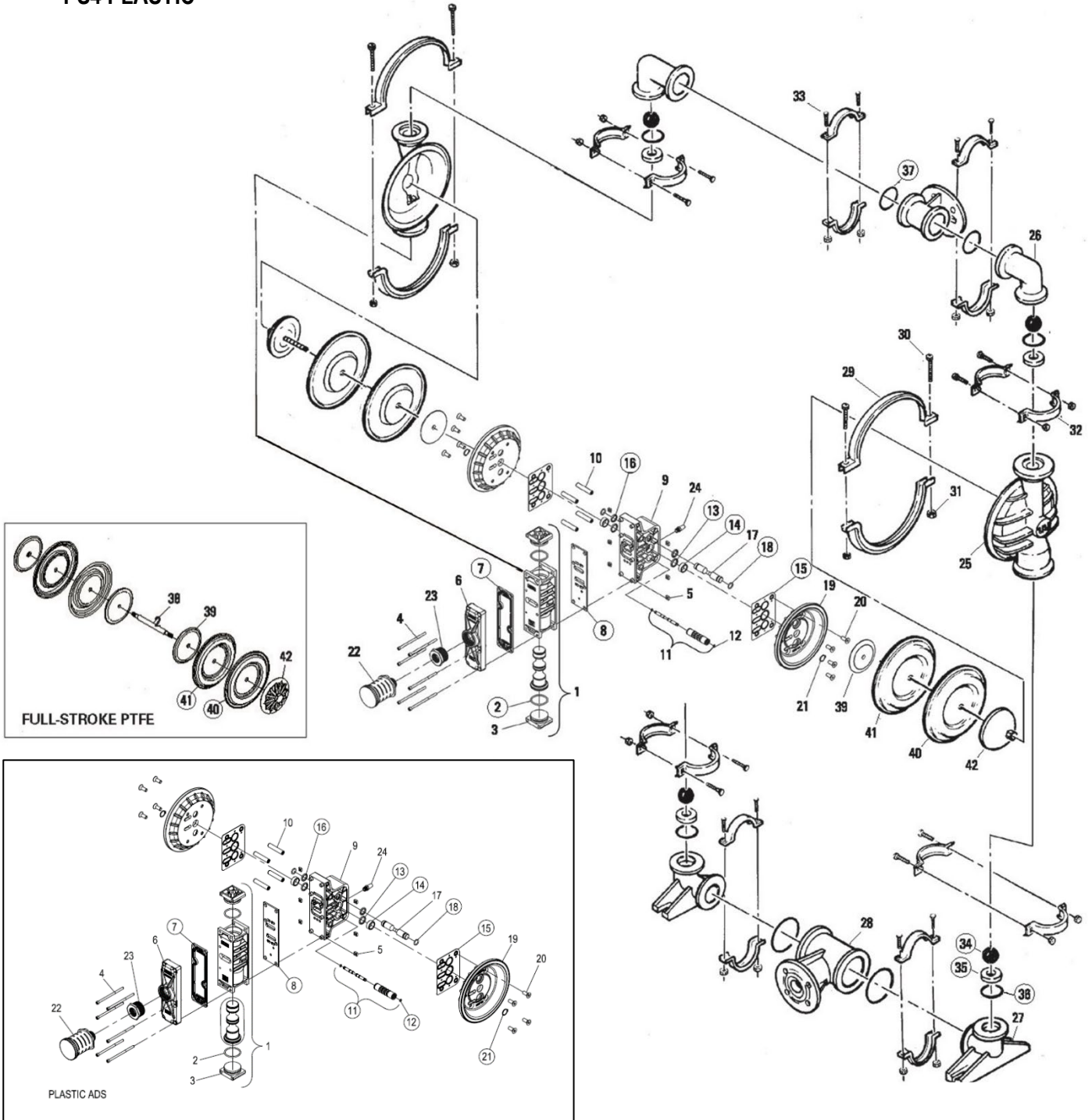
### **Step 3**

The end of the tape should overlap approximately 13 mm (1/2"). Proceed to install the PTFE tape on the remaining diaphragm.

**SECTION 8**

**EXPLODED VIEW AND PARTS LIST**

**PS4 PLASTIC**



ALL CIRCLED PART IDENTIFIERS ARE INCLUDED IN REPAIR KITS

### EXPLODED VIEW AND PARTS LIST

Item	Description	Qty.	Model Description	PS4/PPAPP/	PS4/KKAPP/
				P/N	P/N
<b>Air Distribution Components</b>					
<b>1</b>	<b>Air Valve Assembly, Pro-Flo Shift™ 1</b>	<b>1</b>		<b>04-2039-20</b>	
<b>2</b>	<b>O-Ring, End Cap (-225, Ø1.859" x Ø.139")</b>	<b>2</b>		<b>04-2390-52-700</b>	
3	End Cap	2		04-2330-20-700	
4	Screw, SHC, Air Valve (1/4"-20 x 4-1/2")	6		01-6000-03	
5	Nut, Square (1/4"-20)	6		00-6505-03	
6	Muffler Plate, Pro-Flo Shift™	1		04-3189-20	
<b>7</b>	<b>Gasket, Muffler Plate, Pro-Flo Shift™</b>	<b>1</b>		<b>04-3509-56</b>	
<b>8</b>	<b>Gasket, Air Valve, Pro-Flo Shift™</b>	<b>1</b>		<b>04-2639-56</b>	
9	Center Block Assembly, Pro-Flo Shift™ 2	1		04-3129-20	
10	Sleeve, Threaded, Center Block	4		04-7710-08	
<b>11</b>	<b>Pilot Sleeve Assembly</b>	<b>1</b>		<b>04-3880-99</b>	
<b>12</b>	<b>Pilot Spool Retaining O-Ring (-009, Ø.208" x Ø.070")</b>	<b>2</b>		<b>04-2650-49-700</b>	
<b>13</b>	<b>Seal, Shaft</b>	<b>2</b>		<b>08-3210-55-225</b>	
<b>14</b>	<b>Bushing, Shaft</b>	<b>2</b>		<b>08-3306-13</b>	
<b>15</b>	<b>Gasket, Center Block Pro-Flo Shift™</b>	<b>2</b>		<b>04-3529-56</b>	
<b>16</b>	<b>Seal, Air Control Spool</b>	<b>2</b>		<b>04-3219-49</b>	
17	Air Control Spool	1		04-3859-13	
<b>18</b>	<b>Air Control Spool Retaining O-Ring (-114, Ø.612" x Ø.103")</b>	<b>2</b>		<b>04-3879-50</b>	
19	Air Chamber, Pro-Flo V™	2		04-3660-01	
20	Screw, HSFHS (3/8"-16 x 1")	8		71-6250-08	
21	Retaining Ring	2		04-3890-03	
22	Muffler 1" MNPT	1		15-3514-99R	
23	Bushing, Reducer, 1-1/2" MNPT to 1" FNPT	1		04-6959-17	
24	Muffler, 1/4" MNPT	1		04-3240-07	
<b>Wetted Path Components</b>					
25	Liquid Chamber	2		04-5000-20	04-5000-21
26	Manifold, Discharge Elbow	2		04-5230-20	04-5230-21
27	Manifold, Inlet Elbow	2		04-5220-20	04-5220-21
28	Manifold, Tee section ANSI	2		04-5160-20	04-5160-21
	Manifold, Tee section DIN	2		04-5160-20-504	04-5160-21-504
29	Large Clamp Band Assembly	2		04-7300-03-500	
30	Carriage Bolt, Large Clamp Band (5/16"-18 x 2-1/2")	4		04-6070-03	
31	Hex Nut, Heavy (5/16"-18)	20		08-6400-03	
32	Small Clamp Band Assembly	8		04-7100-03-500	
33	Carriage Bolt, Small Clamp Band (5/16"-18 x 2")	16		08-6050-03-500	
<b>Valve Balls/Valve Seats/Valve O-Rings</b>					
<b>34</b>	<b>Ball, Valve</b>	<b>4</b>		*	
<b>35</b>	<b>Seat, Valve</b>	<b>4</b>		*	
<b>36</b>	<b>Valve Seat O-Ring, (-231, Ø2.609" x Ø.139")</b>	<b>4</b>		*	
<b>37</b>	<b>Tee section O-Ring, (-232, Ø2.734" x Ø.139")</b>	<b>4</b>		*	
<b>Full Stroke Rubber/TPE/PTFE/FSIPD Components</b>					
38	Shaft	1		04-3800-03-700	
39	Piston, Inner	2		04-3700-01-700	
<b>40</b>	<b>Diaphragm, Primary</b>	<b>2</b>		*	
	Diaphragm, IPD Primary	2		*	
<b>41</b>	<b>Diaphragm, Backup</b>	<b>2</b>		*	
42	Piston, Outer	2		04-4550-20-500	04-4550-21-500

LW0210 REV. J

\* See elastomer chart - Section 9

<sup>1</sup> Air Valve Assembly includes items 2 and 3.

<sup>2</sup> Plastic Center Block Assembly includes item 10, 13, 14 and 16.

All boldface items are primary wear parts.

**SECTION 9**
**ELASTOMER OPTIONS**
**PS4 PLASTIC**

MATERIAL	DIAPHRAGM (2)	FULL- STROKE DIAPHRAGMS (2)	FULL-STROKE BACK-UP DIAPHRAGMS (2)	EZ-INSTALL DIAPHRAGMS (2)	FULL-STROKE IPD DIAPHRAGMS (2)	VALVE BALLS (4)	VALVE SEATS (4)	VALVE SEAT O-RING (4)	T-SECTION O-RING (4)
Polyurethane				04-1022-50		04-1080-50		04-1200-50-500	04-1300-50-500
Neoprene	04-1010-51					04-1080-51			
Buna-N	04-1010-52					04-1080-52		04-1200-52-500	04-1300-52-500
Bunast <sup>™</sup>				04-1022-15	04-1031-15				
FKM	04-1010-53					04-1080-53			
EPDM	04-1010-54					04-1080-54			
PTFE		04-1040-55				04-1080-55			
Non-Food Grade Saniflex <sup>™</sup>					04-1031-46				
Saniflex <sup>™</sup>			04-1065-56	04-1022-56	04-1031-56	04-1080-56			
FDA Wil-Flex <sup>®</sup>			04-1065-57	04-1022-57	04-1031-57	04-1080-57			
Wil-Flex <sup>®</sup>				04-1022-58	04-1031-58	04-1080-58			
Polypropylene							04-1120-20-500		
PVDF							04-1120-21-500		
PTFE PFA									
PTFE Encap.(Viton <sup>®</sup> )								04-1200-60-500	04-1300-60-500

LW0210 Rev. J



**NOTES**



**NOTES**

**WILDEN®**

PSG  
22069 Van Buren Street  
Grand Terrace, CA 92313-5651 USA  
P: +1 (909) 422 -1730  
psgdover.com



Where Innovation Flows

---

PSG® reserves the right to modify the information and illustrations contained in this document without prior notice. This is a non-contractual document.