

SALES & ENGINEERING DATA

RATIO SERIES: **1:1**

PD10X-XXX-XXX and PE10X-XXX-XXX 1" METALLIC DIAPHRAGM PUMP

FLUID P.S.I. RANGE: **20 - 120**

RELEASED: 4-13-04
REVISED: 6-9-10
(REV. 05) S-1305

DIMENSIONAL DATA

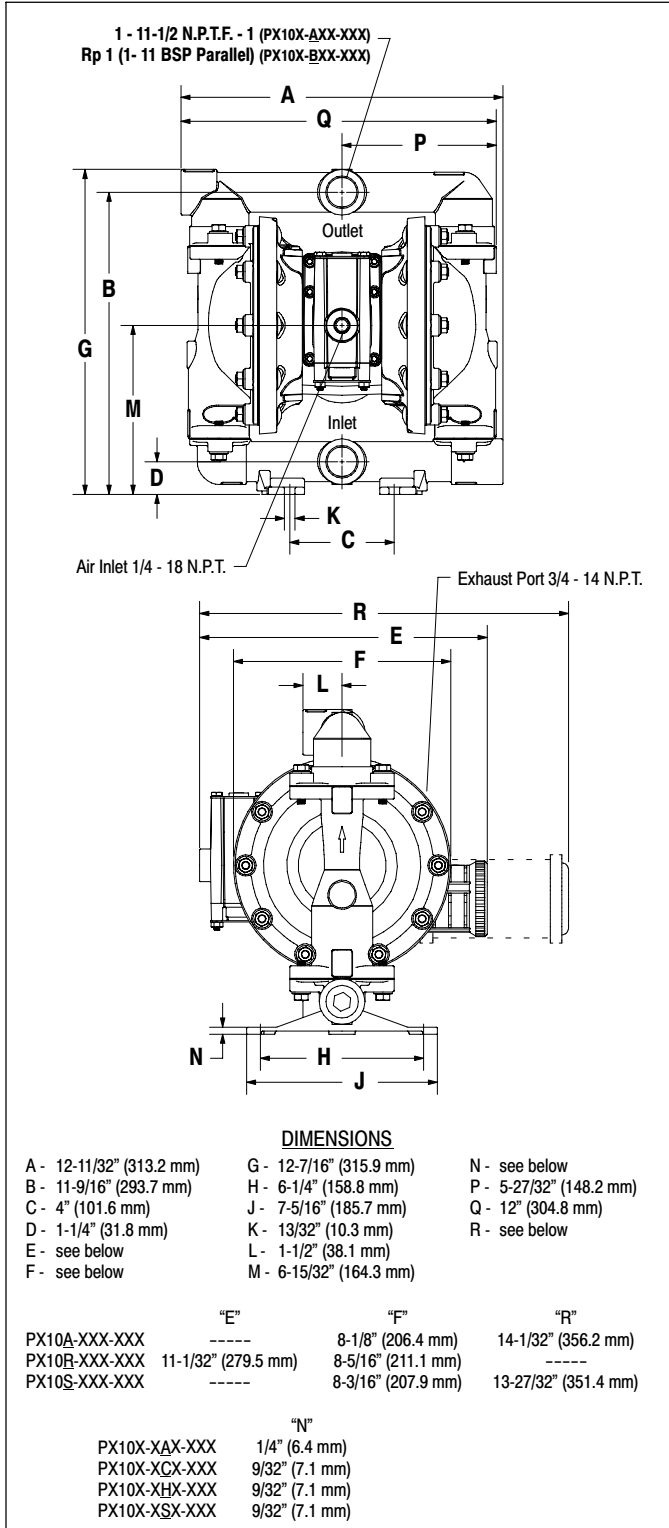

SPECIFICATIONS

CONSTRUCTION

Model Series	PD10X-XXX-XXX PE10X-XXX-XXX
Pump Type	Metallic, Air Operated, Double Diaphragm
Ratio	1:1
Material Inlet / Outlet	
PX10X-AXX-XXX (female)	1 - 11-1/2 N.P.T.F. - 1
PX10X-BXX-XXX (female)	Rp 1 (1 - 11 BSP Parallel)
Air Inlet (female)	1/4 - 18 N.P.T.
Air Exhaust (female)	3/4 - 14 N.P.T.
Weight	PX10R-XAX-XXX 20.65 lbs (9.37 kgs)
	PX10R-XCX-XXX 35.2 lbs (16.0 kgs)
	PX10R-XHX-XXX 39.6 lbs (18.0 kgs)
	PX10R-XSX-XXX 38.2 lbs (17.3 kgs)
	add 4.65 lbs (2.21 kg) for Aluminum air motor section
	add 11.09 lbs (5.03 kg) for Stainless Steel air motor section
Air Section Service Kit	637397
Major Air Valve Assembly	
PD10A-XXX-XXX	637395-3
PD10R-XXX-XXX	637395-1
PD10S-XXX-XXX	637395-5
PE10A-XXX-XXX	637395-4
PE10R-XXX-XXX	637395-2
PE10S-XXX-XXX	637395-6
Fluid Section Service Kit	637401-XX

PX10X-XXX-X

637401 -

Diaphragm Material
Ball Material

EXAMPLE: Model # PD10A-ASP-AAA
Fluid Section Service Kit is 637401-AA

PERFORMANCE

Air Inlet Pressure Range	20 - 120 p.s.i. (1.4 - 8.3 bar)
Maximum Material Inlet Pressure ..	10 p.s.i. (0.69 bar)
Fluid Pressure Range	20 - 120 p.s.i. (1.4 - 8.3 bar)
Maximum Flow Rate (flooded inlet) ...	52.2 g.p.m. (197.6 l.p.m.)
Displacement / Cycle @ 100 p.s.i. ..	0.232 gal. (0.88 lit.)
Maximum Particle Size	1/8" dia. (3.3 mm)
Maximum Temperature Limits (diaphragm / ball / seat material)	
Hytrel	-20° - 150° F (-29° - 66° C)
Nitrile	10° - 180° F (-12° - 82° C)
Polypropylene	35° - 150° F (2° - 66° C)
Santoprene	-40° - 225° F (-40° - 107° C)
PTFE	40° - 225° F (4° - 107° C)
Viton	-40° - 350° F (-40° - 177° C)
Noise Level @ 70 p.s.i. - 60 c.p.m. ..	80.6 db(A)①

① The pump sound pressure level has been updated to an Equivalent Continuous Sound Level (L_{Aeq}) to meet the intent of ANSI S1. 13-1971, CAGI-PNEUROPS S5.1 using four microphone locations.

PERFORMANCE CURVES

PX10X-XXX-XXX 1" METALLIC DIAPHRAGM PUMP

