

# EOM

ENGINEERING OPERATION  
& MAINTENANCE MANUAL

# H1500

# High Pressure Saniflo™ HS Bolted Metal Pumps

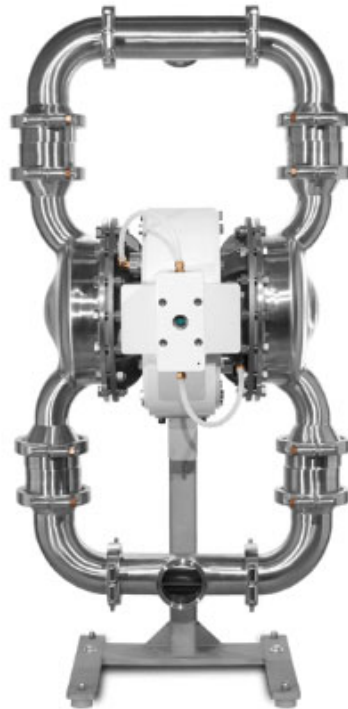

Where Innovation Flows

---

**WILDEN®**



**Copyright**

Copyright 2018 PSG®, a Dover Company. All rights reserved.

PSG reserves the right to modify the information and illustrations in this document without prior notice. The product described in this document is furnished under a license agreement or nondisclosure agreement. No part of this document may be reproduced, stored in a retrieval system, or transmitted in any form or any means electronic or mechanical, including photocopying and recording, without the written permission of PSG, a Dover Company, except as described by the terms of those agreements.

This is a non-contractual document.

**Trademarks**

PSG and the PSG logo are registered trademarks of PSG. Wilden® is a registered trademark of PSG California LLC. Pro-Flo® SHIFT and Pro-Flo® are registered trademarks of PSG California LLC. Wil-Flex® is a trademark of PSG California LLC. Saniflex™ is a trademark of PSG California LLC.

All trademarks, names, logos and service marks (collectively “trademarks”) in this document are registered and unregistered trademarks of their respective owners. Nothing contained in this document should be construed as granting any license or right to use any trademark without the prior written permission of the trademark owner.

**Warranty**

Each and every product manufactured by Wilden is built to meet the highest standards of quality. Every pump is functionally tested to ensure integrity of operation. Wilden warrants that pumps, accessories and parts manufactured or supplied by it to be free from defects in material and workmanship for a period of five (5) years from date of installation or six (6) years from date of manufacture, whichever comes first.

For more information, and to register your Wilden pump for warranty, please visit <https://www.psgdover.com/wilden/support/warranty-registration>.

**Certifications**



**CONTENTS**

**SECTION 1: Precautions – Read First!** ..... 4

**SECTION 2: Wilden Pump Designation System** ..... 5

**SECTION 3: How It Works** ..... 6

**SECTION 4: Dimensional Drawings** ..... 7

**SECTION 5: Performance** ..... 8

    H1500 Saniflo HS Full-Stroke TPE Integral Piston Diaphragm-Fitted ..... 8

    Suction Lift Capability ..... 9

**SECTION 6: Suggested Installation, Operation, Maintenance, and Troubleshooting** ..... 10

**SECTION 7: Disassembly/Reassembly** ..... 13

    Pump Disassembly ..... 13

    Power Cylinder Reassembly ..... 19

    Reassembly Hints and Tips ..... 20

**SECTION 8: Clean-in-Place (CIP)** ..... 22

**SECTION 9: Exploded View and Parts List** ..... 23

**SECTION 10: Elastomer Options** ..... 27

**SECTION 1**

**PRECAUTIONS – READ FIRST!**



**WARNING:** Always wear safety glasses when operating a pump to avoid eye injury. If diaphragm rupture occurs, material being pumped may be forced out of the air exhaust.



**CAUTION:** Do not apply compressed air to the exhaust port – pump will not function.



**CAUTION:** Do not over-lubricate air supply– excess lubrication will reduce pump performance. Pump is pre-lubed.



**TEMPERATURE LIMITS:**

Acetal	-29°C to 82°C	-20°F to 180°F
Buna-N	-12°C to 82°C	10°F to 180°F
Geolast®	-40°C to 82°C	-40°F to 180°F
Neoprene	-18°C to 93°C	0°F to 200°F
Nordel EPDM	-51°C to 138°C	-60°F to 280°F
Nylon	-18°C to 93°C	0°F to 200°F
PFA	-7°C to 107°C	45°F to 225°F
Polypropylene	0°C to 79°C	32°F to 175°F
Polyurethane	-12°C to 66°C	10°F to 150°F
PVDF	-12°C to 107°C	10°F to 225°F
Saniflex	-29°C to 104°C	-20°F to 220°F
SIPD PTFE with EPDM-backed	4°C to 137°C	40°F to 280°F
SIPD PTFE with Neoprene-backed	4°C to 93°C	40°F to 200°F
PTFE*	4°C to 104°C	40°F to 220°F
FKM	-40°C to 177°C	-40°F to 350°F
Wil-Flex	-40°C to 107°C	-40°F to 225°F

\*4°C to 149°C (40°F to 300°F) - 13 mm (1/2") and 25 mm (1") models only.

**NOTE:** Not all materials are available for all models. See "Wilden Pump Designation System" for material options for your pump.



**CAUTION:** When choosing pump materials, be sure to check the temperature limits for all wetted components. Example: FKM has a maximum limit of 177°C (350°F), but polypropylene has a maximum limit of only 79°C (175°F).



**CAUTION:** Maximum temperature limits are based on mechanical stress only. Certain chemicals will reduce maximum safe operating temperatures significantly. Consult the Chemical Resistance Guide for chemical compatibility and temperature limits.



**WARNING:** Prevention of static sparking — If static sparking occurs, fire or explosion could result. Pump, valves, and containers must be grounded to a proper grounding point when handling flammable fluids and whenever discharge of static electricity is a hazard.



**CAUTION:** All Wilden pumps are capable of passing solids. Use a strainer on the pump intake to ensure that the pump's rated solids capacity is not exceeded.



**CAUTION:** Do not exceed 5.9 bar (85 psig) air supply pressure.



**CAUTION:** Do not exceed 82°C (180°F) air inlet temperature for all models.



**CAUTION:** All piping, valves, gauges and other components installed on the liquid discharge must have a minimum pressure rating of 20.7 bar (300 psig).



**CAUTION:** The discharge pressure generated by this pump is 3X the inlet pressure supplied.



**CAUTION:** The process fluid and cleaning fluids must be compatible chemically with all wetted pump components.



**CAUTION:** Before attempting any maintenance or repair, disconnect the compressed air line to the pump and allow all air pressure to bleed from the pump. Disconnect all intake, discharge, and air lines. Drain the pump by turning it upside down and allowing any fluid to flow into a suitable container. Be aware of any hazardous effects of contact with your process fluid.



**CAUTION:** Thoroughly flush pumps before installing them into process lines. Clean and/or sanitize FDA- and USDA-approved pumps before using them.



**CAUTION:** Before attaching the air line to the pump, blow out the air line for 10 to 20 seconds to make sure all pipeline debris is clear. Use an in-line air filter. A 5µ (micron) air filter is recommended.



**CAUTION:** Before installation, tighten all hardware.



**NOTE:** Materials of construction and elastomer material may influence suction lift parameters. Please refer to "Performance" for specifics.



**NOTE:** When installing PTFE diaphragms, it is important to tighten outer pistons simultaneously (turning in opposite directions) to ensure tight fit. (See "Maximum Torque Specifications").



**NOTE:** Some PTFE-fitted pumps come standard from the factory with expanded PTFE gaskets installed in the diaphragm bead of the liquid chamber. PTFE gaskets cannot be re-used.



**NOTE:** In the event of a power failure, close the shut-off valve if you do not want the pump to restart when the power returns.



**NOTE:** The Safety Supplement document is a part of the manual. Please refer to the Safety Supplement document for a complete list of safety considerations including considerations for safe operation and maintenance of pumps marked for ATEX environments before starting the pump.



**WARNING:** This product can expose you to chemicals including Nickel, Chromium, Cadmium, or Cobalt, which are known to the State of California to cause cancer and/or birth defects or other reproductive harm. For more information, go to [www.P65Warnings.ca.gov](http://www.P65Warnings.ca.gov).

**SECTION 2**

**WILDEN PUMP DESIGNATION SYSTEM**

**H1500 SANIFLO HYGIENIC SERIES**

76 mm (3") Pump

Maximum Flow Rate:  
291 lpm (77 gpm)

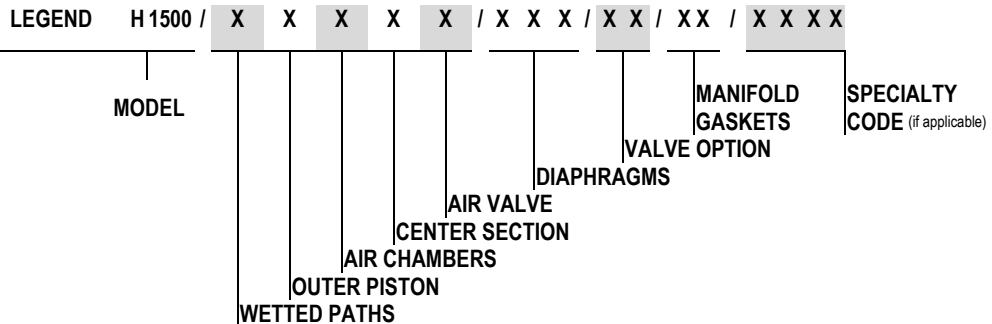

**MATERIAL CODES**

<b>MODEL</b> H1500 = 76 MM (3") HIGH PRESSURE SANIFLO HYGIENIC SERIES	<b>AIR VALVE</b> I = POWDER-COATED ALUMINUM	<b>VALVE BALLS/ MUSHROOM CHECK</b> FW = SANITARY WIL-FLEX™ [SANTOPRENE® (TWO BLACK DOTS)] <sup>1</sup> TF = PTFE (WHITE) <sup>1,2</sup> TM = PTFE MUSHROOM CHECK <sup>1,2</sup>
<b>WETTED PATH</b> S = STAINLESS STEEL	<b>DIAPHRAGMS</b> FWL = SANITARY WIL-FLEX™, IPD [SANTOPRENE® (TWO BLACK DOTS)] <sup>1</sup> FWS = SANITARY WIL-FLEX™, EZ-INSTALL [SANTOPRENE® (TWO BLACK DOTS)] <sup>1</sup>	<b>MANIFOLD GASKET</b> FE = SANITARY EPDM <sup>1</sup> (Green Dot) FV = SANITARY FKM <sup>1</sup> (One White/One Yellow Dot) TF = PTFE (White) <sup>1,2</sup>
<b>OUTER PISTON</b> S = STAINLESS STEEL Z = NO OUTER PISTON	TSS = FULL-STROKE PTFE W/SANIFLEX™ BACK-UP <sup>1,2</sup> TWS = FULL-STROKE PTFE W/WIL-FLEX™ BACK-UP [SANTOPRENE® (THREE BLACK DOTS)] <sup>1,2</sup>	<b>NOTES:</b> <sup>1</sup> Meets Requirements of FDA CFR21.177 <sup>2</sup> Meets Requirements of USPClass VI
<b>AIR CHAMBERS</b> S = STAINLESS STEEL		
<b>CENTER SECTION</b> I = POWDER-COATED ALUMINUM		

**SPECIALTY CODES**

0770 Saniflo™ HS  
0770E Saniflo™ HS (1935/2004/EC)

- NOTE:** Most elastomeric materials use colored dots for identification
- NOTE:** Not all models are available with all material options

## SECTION 3

## HOW IT WORKS – AIR-OPERATED DOUBLE-DIAPHRAGM PUMP

The Wilden diaphragm pump is an air-operated, positive displacement, self-priming pump. These drawings show flow pattern through the pump upon its initial stroke. It is assumed the pump has no fluid in it prior to its initial stroke.

**Preface:** The H1500 uses an integral power-amplifier piston together with two diaphragms to yield a pressure ratio of 3:1 (e.g., 85 psig air inlet will develop pump discharge pressures up to 250 psig). Air is simultaneously directed behind the amplifier piston as well as one of the diaphragms via specialized air manifold porting. The sum of the two surface areas is three times that of the diaphragm. Therefore, the discharge is amplified by a 3:1 pressure output ratio.

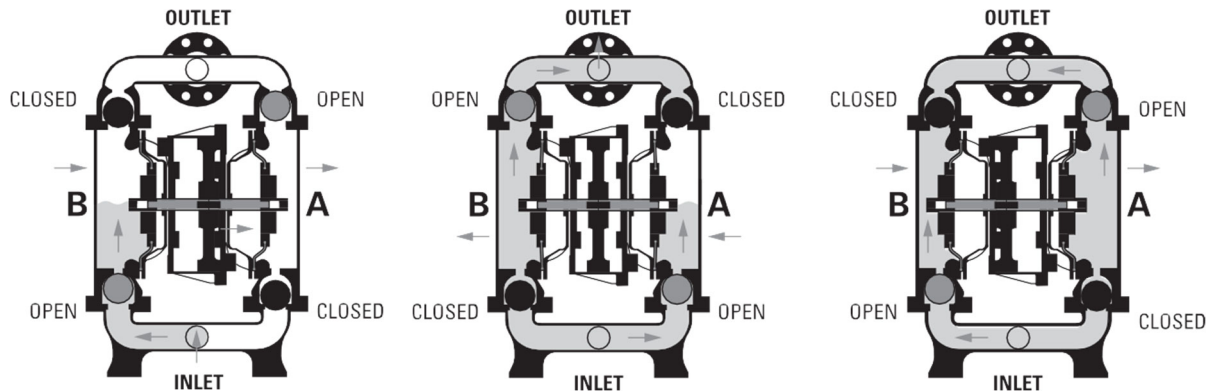

**FIGURE 1** When air pressure is supplied to the pump, the air valve directs pressure to the back side of diaphragm A. The compressed air moves the diaphragm away from the center section of the pump. The opposite diaphragm is pulled in by the shaft connected to the pressurized diaphragm. Diaphragm B is on its suction stroke; air behind the diaphragm has been forced out to the atmosphere through the exhaust port. The movement of diaphragm B towards the center section of the pump creates a vacuum within chamber B. Atmospheric pressure forces fluid into the inlet manifold forcing the inlet valve ball off of its seat. Liquid is free to move past the inlet valve ball and fill the liquid chamber (see shaded area).

**FIGURE 2** Once the shaft has reached the end of its stroke, the air valve redirects pressurized air to the back side of diaphragm B.

**FIGURE 3** At completion of the stroke, the air valve again redirects air to the back side of diaphragm A, which starts diaphragm B on its exhaust stroke. As the pump reaches its original starting point, each diaphragm has gone through one exhaust and one discharge stroke. This constitutes one complete pumping cycle. The pump may take several cycles to completely prime depending on the condition of the application.

**SECTION 4**

**DIMENSIONAL DRAWING**

**H1500 HS Vertically-Mounted,  
Center-Ported with Ball/Mushroom Valve**

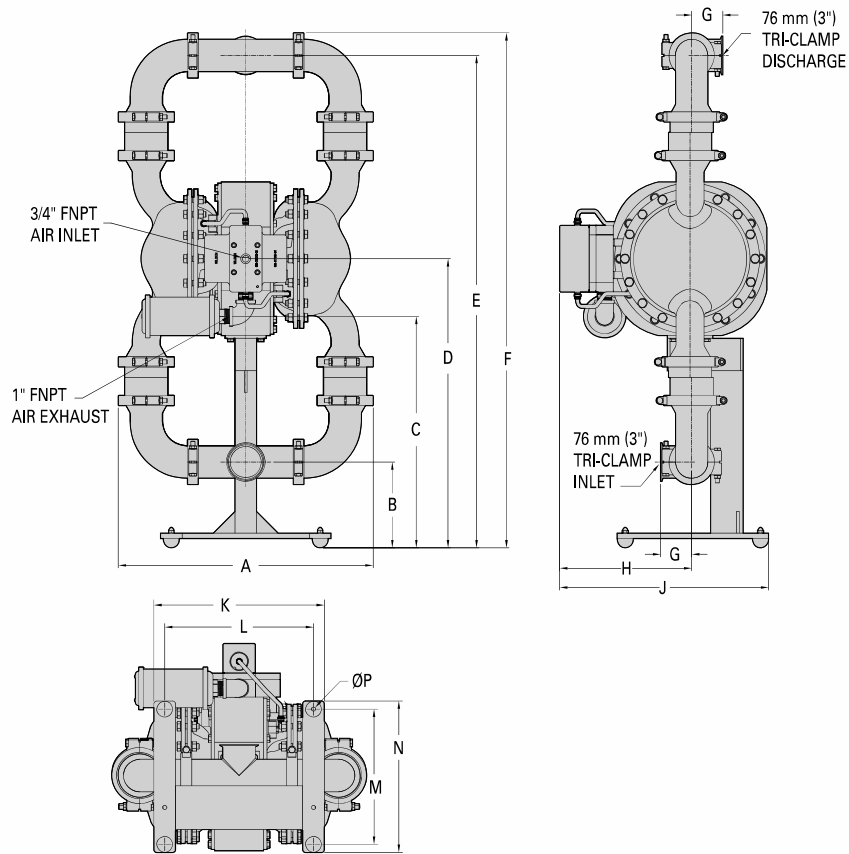

**DIMENSIONS**

ITEM	METRIC (mm)	STANDARD (inch)
A	599	23.6
B	201	7.9
C	543	21.4
D	678	26.7
E	1156	45.5
F	1209	47.6
G	74	2.9
H	310	12.2
J	490	19.3
K	401	15.8
L	351	13.8
M	318	12.5
N	356	14.0
P	010	0.4

LW0115 REV. A

**SECTION 5**

**PERFORMANCE**

**H1500 HS  
FULL-STROKE  
INTEGRAL PISTON  
DIAPHRAGM-FITTED**

Ship Weight.....	115 kg (254 lb)
Air Inlet.....	3/4"
Inlet.....	76 mm (3")
Outlet.....	76 mm (3")
Suction Lift.....	3.8 m Dry (12.5')
	9.0 m Wet (29.5')
Disp. Per Stroke <sup>1</sup> .....	1.2 L (0.32 gal)
Max. Flow Rate.....	291 lpm (77 gpm)
Max. Size Solids.....	6.4 mm (1/4")

<sup>1</sup>Displacement per stroke was calculated at 4.8 bar (70 psig) air inlet pressure against a 2.1 bar (30 psig) head pressure.

**Example:** To pump 83.2 lpm (22 gpm) against a discharge head of 9.6 bar (140 psig) requires 4.1 bar (60 psig) and 123 Nm<sup>3</sup>/h (72 scfm) air consumption. (See dot on chart.)

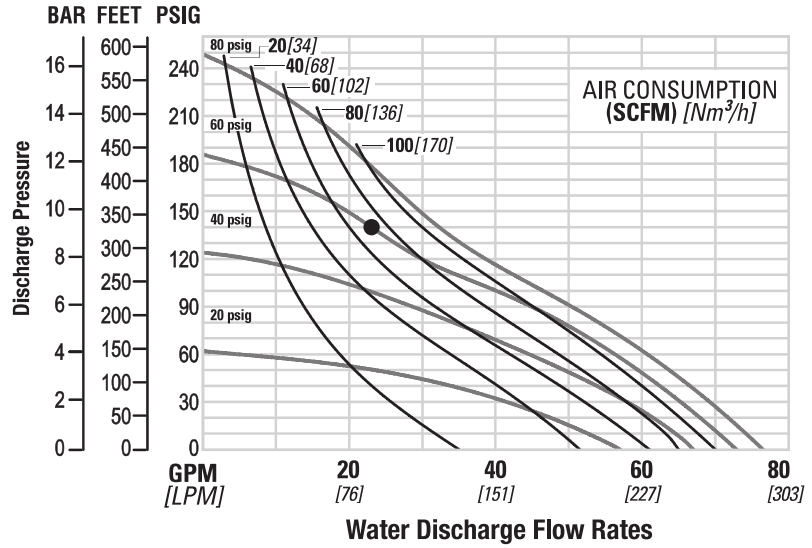

Flow rates indicated on chart were determined by pumping water. For optimum life and performance, pumps should be specified so that daily operation parameters will fall in the center of the pump's performance curve.

**Caution:** Do not exceed 5.9 bar (85 psig) air supply pressure.

**SUCTION LIFT CAPABILITY**

**H1500 SUCTION LIFT CAPABILITY**

Suction-lift curves are calibrated for pumps operating at 305 m (1,000') above sea level. This chart is meant to be a guide only. There are many variables that can affect your pump's operating characteristics. The number of intake and discharge elbows, viscosity of pumping fluid, elevation (atmospheric pressure) and pipe friction loss all affect the amount of suction lift your pump will attain.

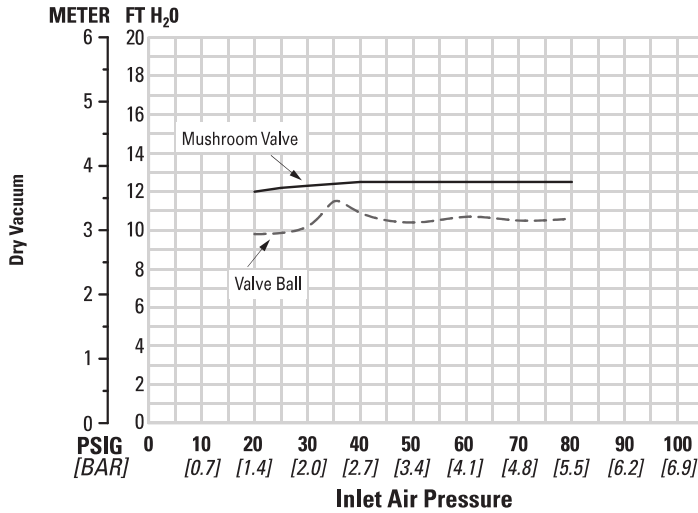

## SECTION 6

SUGGESTED INSTALLATION, OPERATION, MAINTENANCE  
AND TROUBLESHOOTING

Wilden pumps are designed to meet the performance requirements of even the most demanding pumping applications. They have been designed and manufactured to the highest standards and are available in a variety of liquid path materials to meet your chemical resistance needs. Refer to "Performance" for an in-depth analysis of the performance characteristics of your pump. Wilden offers the widest variety of elastomer options in the industry to satisfy temperature, chemical compatibility, abrasion resistance and flex concerns.

The suction pipe size should be at least equal to or larger than the diameter size of the suction inlet on your Wilden pump. The suction hose must be a non-collapsible, reinforced type because these pumps are capable of pulling a high vacuum. Discharge piping should also be equal to or larger than the diameter of the pump discharge, which will help reduce friction losses.



**CAUTION:** All fittings and connections must be airtight. Otherwise, pump suction capability will be reduced or lost.

Months of careful planning, study and selection efforts can result in unsatisfactory pump performance if installation details are left to chance. You can avoid premature failure and long-term dissatisfaction by exercising reasonable care throughout the installation process.

**Location**

Noise, safety and other logistical factors usually dictate where equipment will be situated on the production floor. Multiple installations with conflicting requirements can result in congestion of utility areas, leaving few choices for additional pumps.

Within the framework of these and other existing conditions, locate every pump in such a way that the following six key factors are balanced against each other to maximum advantage:

- **Access:** First, the location should be accessible. If it's easy to reach the pump, maintenance personnel will be able to perform routine inspections and adjustments more easily. If major repairs become necessary, ease of access can play a key role in speeding the repair process and reducing total downtime.
- **Air Supply:** Every pump location should have an air line large enough to supply the volume of air necessary to achieve the desired pumping rate. Use up to a maximum of 5.9 bar (85 psig) air supply pressure.
- **Solenoid Operation:** When operation is controlled by a solenoid valve in the air line, three-way valves should be used. This valve allows trapped air between the valve and the pump to bleed off, which improves pump performance. You can estimate pumping volume by counting the number of strokes per minute, and then multiplying that figure by the displacement per stroke.
- **Muffler:** Using the standard Wilden muffler, sound levels are reduced below OSHA specifications. You can use other mufflers to reduce sound levels farther, but they usually reduce pump performance.
- **Elevation:** Selecting a site that is well within the pump's dynamic lift capability will assure that loss-of-prime issues will be eliminated. In addition, pump efficiency can be adversely affected if proper attention is not given to site location.
- **Piping:** Final determination of the pump site should not be made until the piping challenges of each possible location have been evaluated. The impact of current and future installations should be considered ahead of time to make sure that inadvertent restrictions are not created for any remaining sites.

The best choice possible will be a site involving the shortest and straightest hook-up of suction and discharge piping. Unnecessary elbows, bends and fittings should be avoided. Pipe sizes should be selected to keep friction losses within practical limits. All piping should be supported independently of the pump. In addition, the piping should be aligned to avoid placing stress on the pump fittings.

Flexible hose can be installed to aid in absorbing the forces created by the natural reciprocating action of the pump. If the pump is to be bolted down to a solid location, a mounting pad placed between the pump and the foundation will assist in minimizing pump vibration. Flexible connections between the pump and rigid piping will also assist in minimizing pump vibration.

If the pump is to be used in a self-priming application, make sure that all connections are airtight and that the suction lift is within the model's ability.



**NOTE:** Materials of construction and elastomer material have an effect on suction lift parameters. Please refer to "Performance" for specifics.

When pumps are installed in applications involving flooded suction or suction head pressures, a gate valve should be installed in the suction line to permit closing of the line for pump service.

Pumps in service with a positive suction head are most efficient when inlet pressure is limited to 0.5–0.7 bar (7–10 psig). Premature diaphragm failure may occur if positive suction is 0.7 bar (10 psig) and higher.

**Single-Point Exhaust**

Pro-Flo SHIFT pumps can be used for submersible applications when using the Pro-Flo SHIFT's single-point exhaust.



**CAUTION:** All Wilden pumps are capable of passing solids. Use a strainer on the pump intake to ensure that the pump's rated solids capacity is not exceeded.



**CAUTION:** Do not exceed 5.9 bar (85 psig) air supply pressure.

**SUGGESTED INSTALLATION, OPERATION, MAINTENANCE AND TROUBLESHOOTING**

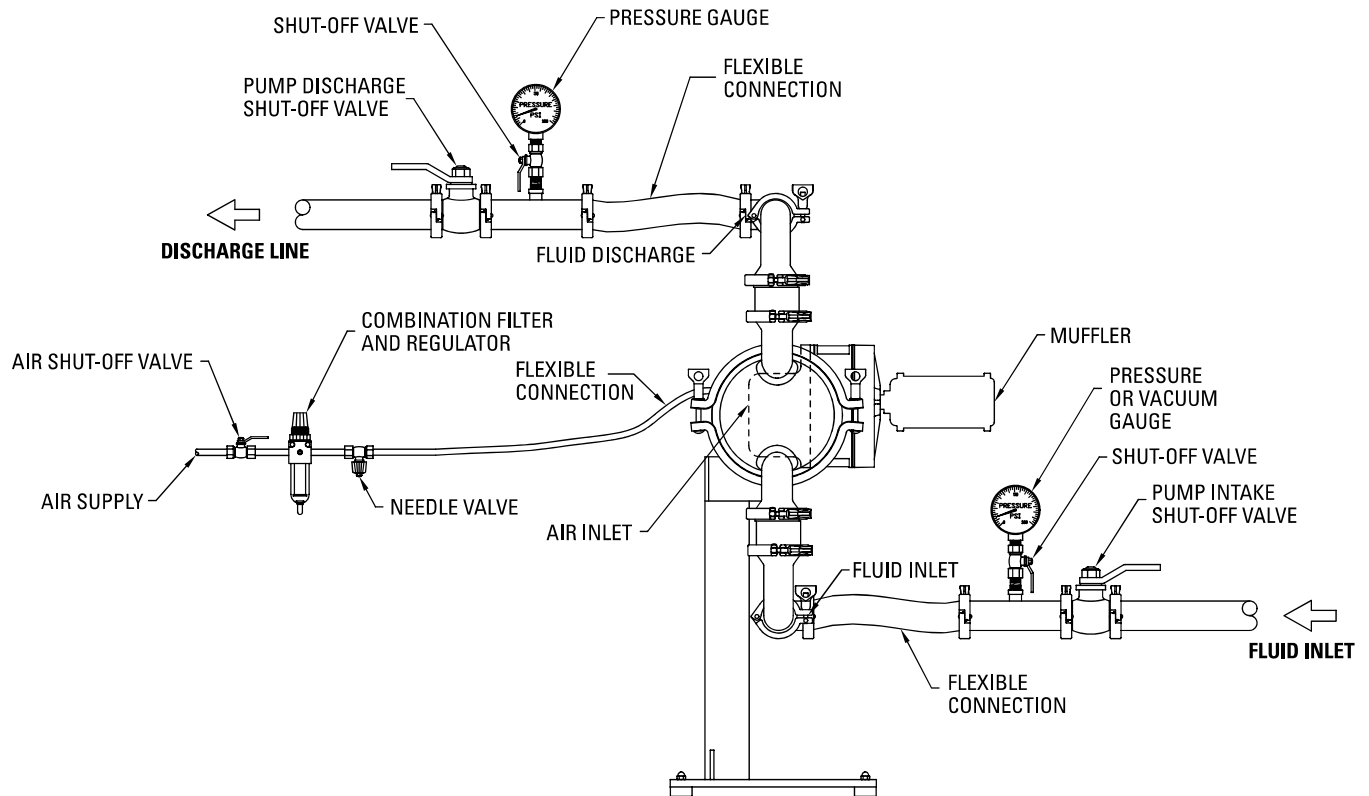

**!** **NOTE:** In the event of a power failure, close the shut-off valve if you do not want the pump to restart when the power returns.

**Air-Operated Pumps:** To stop the pump from operating in an emergency, simply close the shut-off valve (user-supplied) installed in the air supply line. A properly functioning valve will stop the air supply to the pump, therefore stopping output. This shut-off valve should be located far enough away from the pumping equipment such that it can be reached safely in an emergency.

**Operation**

Pump discharge rate can be controlled by limiting the volume and/or pressure of the air supply to the pump. An air regulator is used to regulate air pressure. A needle valve is used to regulate volume. Pump discharge rate also can be controlled by throttling the pump discharge by partially closing a valve in the discharge line of the pump. This action increases friction loss, which reduces flow rate. (See "Performance") This is useful when the need exists to control the pump from a remote location. When the pump discharge pressure equals or exceeds the air supply pressure, the pump will stop. No bypass or pressure relief valve is needed, and pump damage will not occur. The pump has reached a "deadhead" situation and can be restarted by reducing the fluid discharge pressure or increasing the air inlet pressure. The Wilden High Pressure Pumps run solely on compressed air and does not generate heat, therefore your process fluid temperature will not be affected.

**Maintenance and Inspections**

Because each application is unique, maintenance schedules maybe different for every pump. Frequency of use, line pressure, viscosity and abrasiveness of process fluid all affect the parts life of a Wilden pump. Periodic inspections have been found to offer the best means for preventing unscheduled pump downtime. Personnel familiar with the pump's construction and service should be informed of any abnormalities that are detected during operation.

**Records**

When service is required, a record should be made of all necessary repairs and replacements. Over a period of time, such records can become a valuable tool for predicting and preventing future maintenance problems and unscheduled downtime. In addition, accurate records make it possible to identify pumps that are poorly suited to their applications.

## SUGGESTED INSTALLATION, OPERATION, MAINTENANCE AND TROUBLESHOOTING

### Troubleshooting

#### ***Pump will not run or runs slowly.***

1. Remove plug from pilot spool exhaust.
2. Ensure that the air inlet pressure is at least 0.4 bar (5 psig) above startup pressure and that the differential pressure (the difference between air inlet and liquid discharge pressures) is not less than 0.7 bar (10 psig).
3. Check air inlet filter for debris (see "Suggested Installation, Operation, Maintenance and Troubleshooting").
4. Check for extreme air leakage (blow by) that would indicate worn seals/bores in the air valve, pilot spool and main shaft.
5. Disassemble the pump and check for obstructions in the air passageways or objects that would obstruct the movement of internal parts.
6. Check for sticking ball check valves.
  - a. If material being pumped is not compatible with pump elastomers, swelling may occur. Replace ball check valves and seals with proper elastomers.
  - b. Also, as the check valve balls wear out, they become smaller and can become stuck in the seats. In this case, replace balls and seats.
7. Check for any broken inner piston that would cause the air valve spool to be unable to shift.

#### ***Pump runs, but little or no product flows.***

1. Check for pump cavitation. Slow pump speed down to allow thick material to flow into liquid chambers.
2. Verify that vacuum required to lift liquid is not greater than the vapor pressure of the material being pumped (cavitation).
3. Check for sticking ball check valves.
  - a. If material being pumped is not compatible with pump elastomers, swelling may occur. Replace ball check valves and seals with proper elastomers.
  - b. Also, as the check valve balls wear out, they become smaller and can become stuck in the seats. In this case, replace balls and seats.

#### ***Pump air valve freezes.***

1. Check for excessive moisture in the compressed air.
  - a. Either install a dryer or a hot air generator for compressed air.
  - b. Alternatively, you may use coalescing filter to remove the water from the compressed air in some applications.

#### ***Air bubbles in pump discharge.***

1. Check for a ruptured diaphragm.
2. Check tightness of outer pistons (see "Disassembly/Reassembly").
3. Check tightness of fasteners and integrity of O-rings and seals, especially at intake manifold.
4. Ensure pipe connections are airtight.

#### ***Product comes out air exhaust.***

1. Check for a diaphragm rupture.
2. Check the tightness of the outer pistons to the shaft.

## SECTION 7

## DISASSEMBLY / REASSEMBLY

## PUMP DISASSEMBLY

## Tools Required:

- Hex wrenches
- Ratchet and socket set
- O-ring pliers
- Snap-ring pliers
- Torque wrench
- Combination wrench set and/or adjustable wrenches
- Vise equipped with soft jaws (such as plywood, plastic or other suitable materials)



**CAUTION:** Before attempting any maintenance or repair, disconnect the compressed air line to the pump and allow all air pressure to bleed from the pump. Disconnect all intake, discharge, and air lines. Drain the pump by turning it upside down and allowing any fluid to flow into a suitable container. Be aware of any hazardous effects of contact with your process fluid.



**NOTE:** Your specific pump model may vary from the configuration shown; however, pump disassembly procedure will be the same.

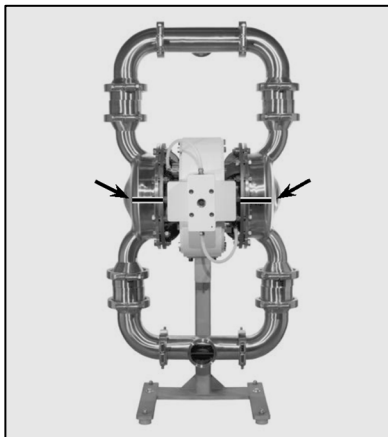

**NOTE:** Replace worn parts with genuine Wilden parts for reliable performance.

**Step 1**

Prior to assembly, place alignment marks on the liquid chambers and air chambers to assist with proper alignment during reassembly.

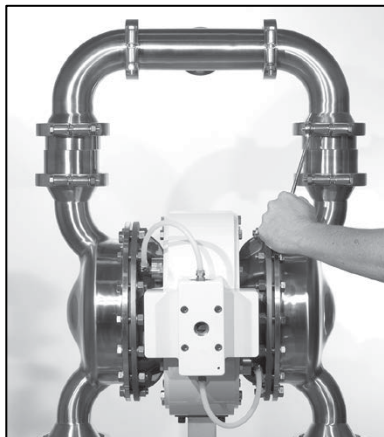
**Step 2**

Loosen the fasteners for the clamp band using an appropriate-sized wrench.

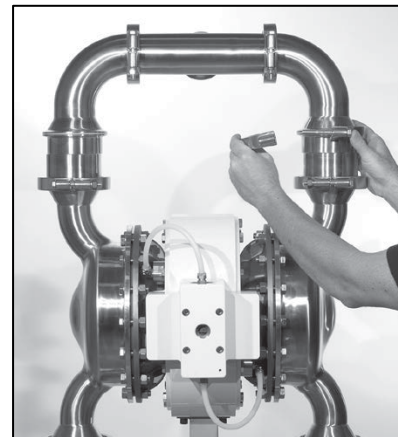
**Step 3**

Remove the clamp band assemblies on discharge manifold.

**DISASSEMBLY / REASSEMBLY**

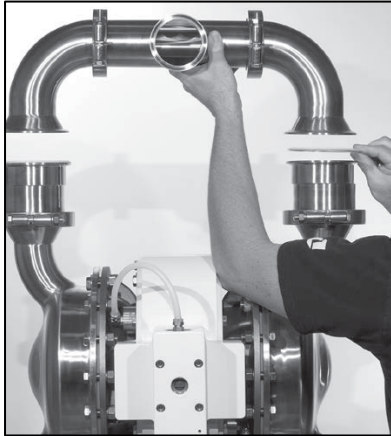

**Step 4**

Remove the discharge manifold and manifold gaskets.

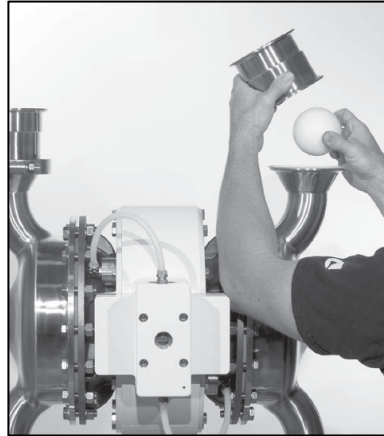

**Step 5**

Next, remove the clamp bands that secure the ball valve housing to the liquid chamber. Remove the ball valve housing, valve ball and gasket. After removing ball valve housing, inspect for abrasion in the ball cage area.

**NOTE:** If your pump is fitted with a mushroom valve, remove the mushroom valve housing, mushroom valve and gasket.

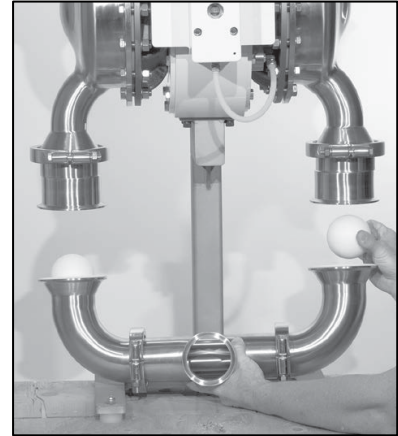

**Step 6**

Loosen the nut and remove the inlet manifold clamp bands. Next, remove the clamp bands that secure the valve housing to the liquid chamber. After removing ball valve housing, inspect for abrasion in the inlet manifold area.



**Step 7**

Next, remove the ball valve housing, valve ball and gasket from liquid chamber. To ensure proper alignment during reassembly of manifold/liquid chamber interface, turn off-set portion of valve housing to the left or to the right. This procedure works for the inlet and discharge manifold connections.



**Step 8**

Inspect the ball valve housing and valve ball for signs of abrasion.

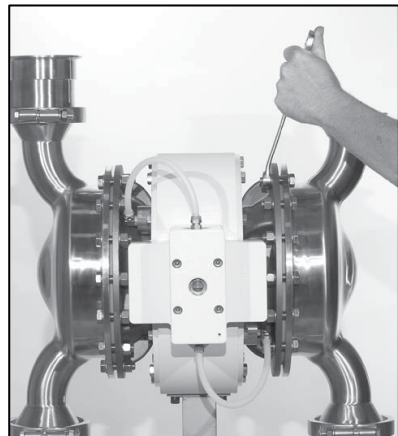

**Step 9**

Using the appropriate-sized wrenches, disconnect the inlet manifold from the center section.

**DISASSEMBLY / REASSEMBLY**

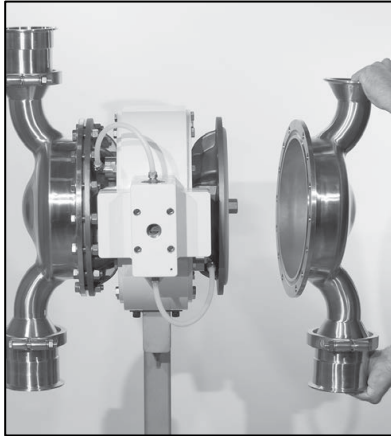

**Step 10**

Next, remove the liquid chamber from the center section assembly.

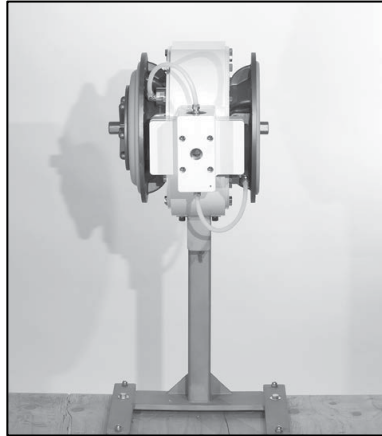

**Step 11 (if applicable)**

If your pump is fitted with an integral piston diaphragm (IPD), when you remove the liquid chamber you will notice that there is no outer piston.

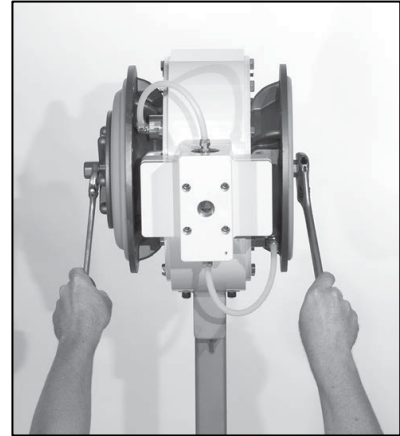

**Step 12**

Using appropriate-sized wrenches, turning in the opposite direction, loosen and remove one of the two (2) outer pistons.

**NOTE:** With an IPD, the procedure for removing the diaphragm is slightly different. In this case, simply grasp the diaphragm in two locations and turn in a counter-clockwise direction.

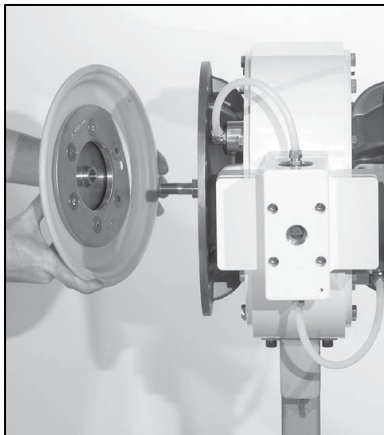

**Step 13**

After loosening, remove the outer piston and diaphragm assembly.

**NOTE:** If using an IPD, un-thread from the shaft.

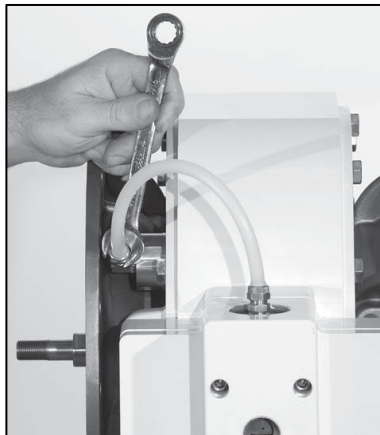

**Step 14**

Loosen tubing nuts located at each pressure relief valve. Next, loosen pipe fitting and elbow. This will allow easy access to the relief valve. Using the appropriate-sized wrench, remove each pressure relief valve.

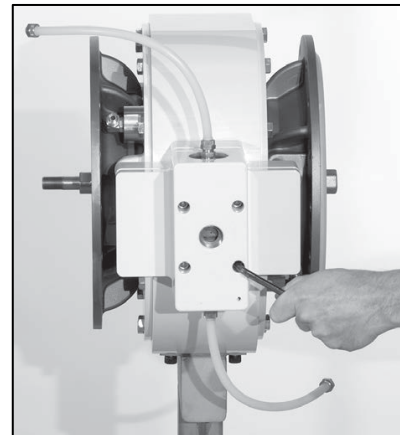

**Step 15**

Using the appropriate-sized wrench, remove the fasteners that connect the air valve and air valve gasket to the center section.

**DISASSEMBLY / REASSEMBLY**

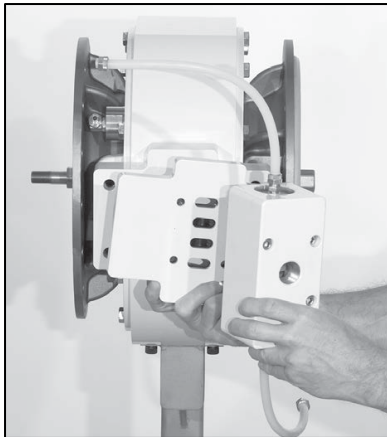

**Step 16**

Lift air valve and isolator cover away from pump.

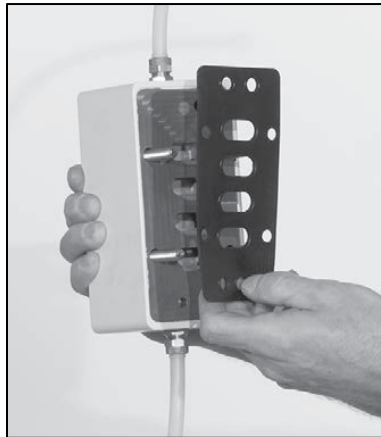

**Step 17**

Inspect air valve gasket for nicks, gouges, chemical attack and replace if necessary with genuine Wilden parts.

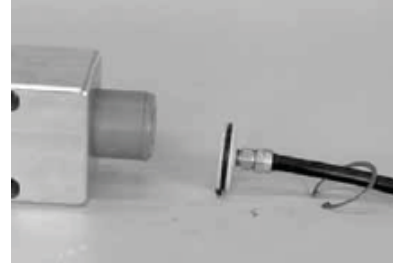

**Step 18**

Using a pair of snap-ring pliers, remove one snap-ring from the air valve body. Inspect air piston, air valve body and air valve end cap for nicks, gouges, chemical attack or abrasive wear.  
**HINTS & TIPS:** Using an air nozzle, alternately pressurize top and bottom bleeder holes until the top end cap is forced from air valve body.

**CAUTION:** End cap may come out with considerable force. Position a shop rag or equivalent over the top end cap to ensure that the end cap doesn't harm the pump technician or anyone else in the immediate area of the pump.

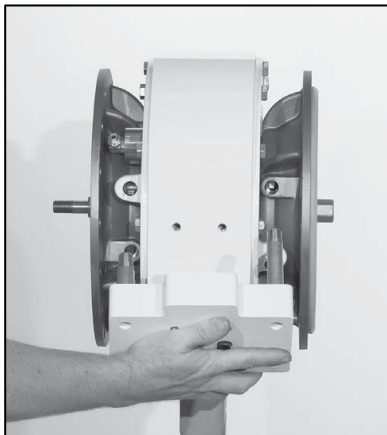

**Step 19**

Using a hex wrench, remove the two (2) air-valve manifold fasteners.

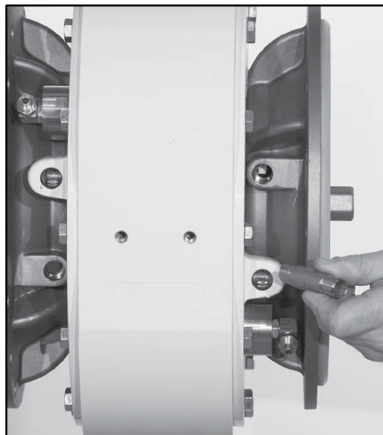

**Step 20**

Located behind the air valve manifold are four (4) tubes [two short (2) and two (2) longer]. Remove all four (4) tubes from pump.



**Step 21**

After removing tubes inspect or replace the O-rings as needed.

**DISASSEMBLY / REASSEMBLY**

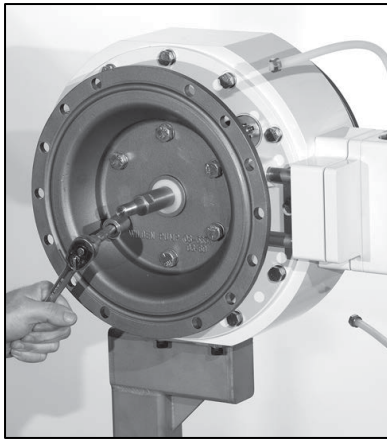

**Step 22**

Using the appropriate-sized wrench, remove the air chamber fasteners.

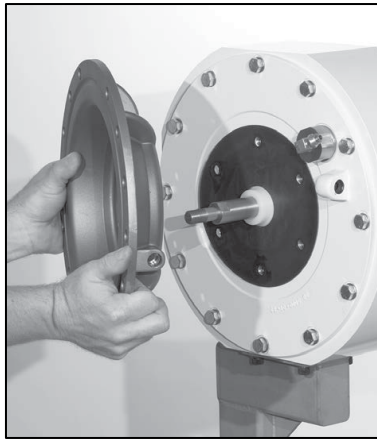

**Step 23**

Remove the air chamber fasteners and gasket.

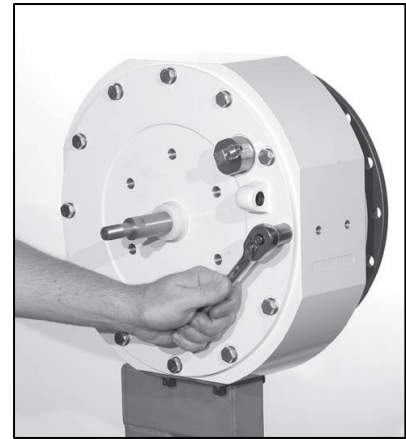

**Step 24**

Using a socket wrench, unbolt the power cylinder cover from the center section.

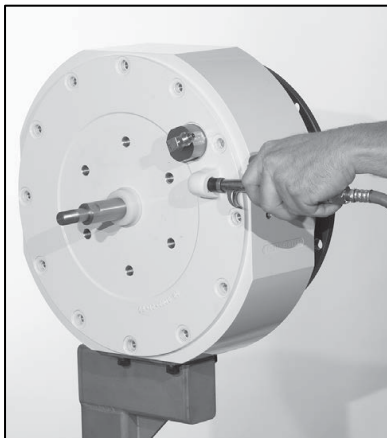

**Step 25**

Using an air nozzle with a rubber tip, apply air to the air manifold tube port.

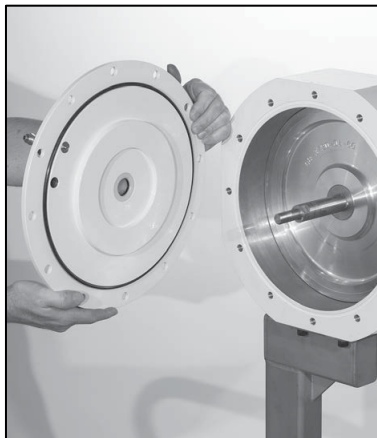

**Step 26**

This will force the power cylinder cover away from the power cylinder body. Inspect shaft bushing seals and O-ring on power cylinder cover for damage.

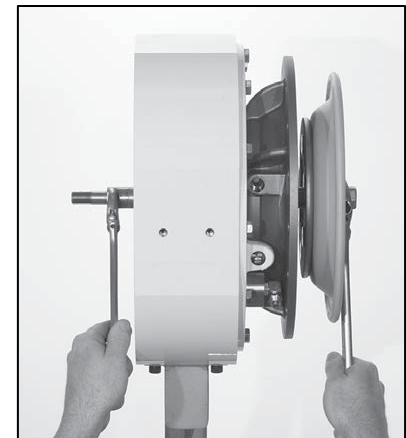

**Step 27**

Using two appropriate-sized wrenches, turning in the opposite direction, loosen and remove shaft diaphragm assembly.

**DISASSEMBLY / REASSEMBLY**

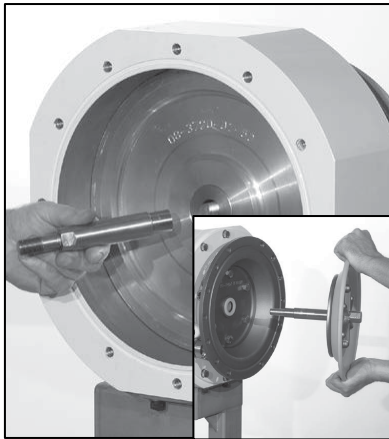

**Step 28**

Remove the outer piston, diaphragm and shaft assembly from the air chamber.

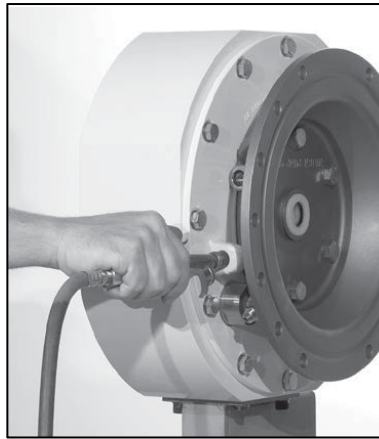

**Step 29**

Using an air nozzle with a rubber tip, apply air to the air manifold tube. This will force the power cylinder piston away from the power cylinder body.

Continue to apply air pressure to the air manifold tube port until the power cylinder piston is moved out of the power cylinder body.



**Step 30**

Retain the shaft bushings for use in reassembly.

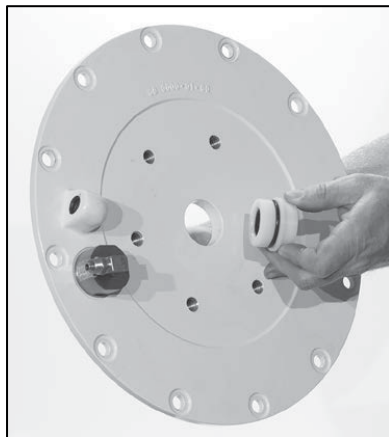

**Step 31**

Inspect the center section cover and bushings. Replace if necessary with genuine Wilden parts.

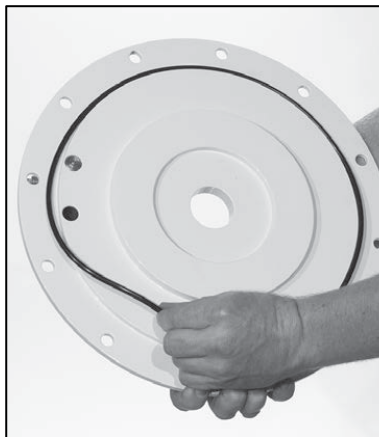

**Step 32**

Inspect the O-ring cover for nicks, gouges, chemical attack or abrasion. Replace if necessary with genuine Wilden parts.



**Step 33**

Using a hex wrench, remove the fasteners that connect the inner piston to the diaphragm assembly. Inspect diaphragm for nicks, gouges, chemical attack or abrasion. Replace if necessary with genuine Wilden parts.

**DISASSEMBLY / REASSEMBLY**

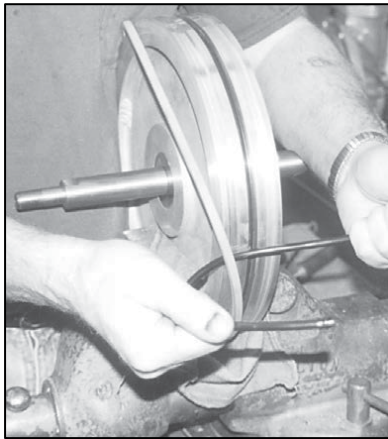

**Power Cylinder Reassembly  
Step 1**

After attaching the diaphragm shaft and bushing to the power cylinder piston, place power cylinder piston in vice with soft jaws (do not damage piston) . Next, install new slipper seal.

**HINTS & TIPS:** Using a strip of material (like an old O-ring), slide the material back and forth until the slipper seal is positioned above the center groove.



**Step 2**

Next, place the power cylinder and power cylinder piston on top of two blocks of wood or equivalent.



**Step 3**

Insert new guide rings in outer grooves. Very easily, begin to maneuver the power cylinder piston into the power cylinder body.

**HINTS & TIPS:** A conical (tapered) piece of cylindrical sheet material or equivalent can be used to hold the guide rings in place as the power cylinder piston slides into the power cylinder body.

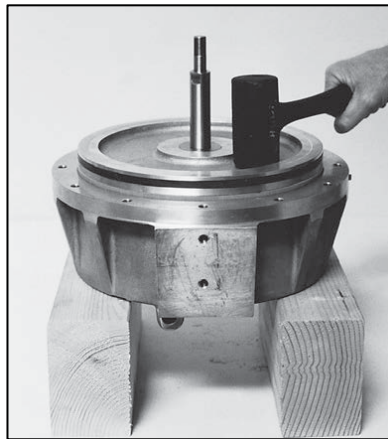

**Step 4**

Using a rubber mallet, lightly tap power cylinder piston in a circular fashion until piston is maneuvered completely into power cylinder body. When performing this task, use caution to not damage the guide rings or slipper seal.

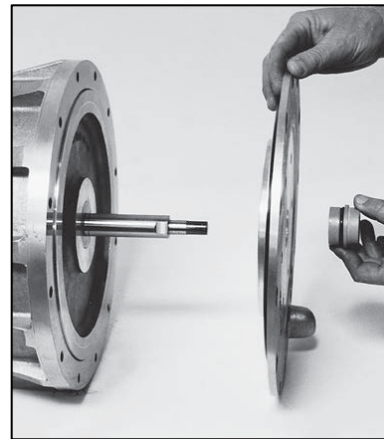

**Step 5**

As a last step install power cylinder cover to power cylinder body and secure with fasteners provided.

**DISASSEMBLY / REASSEMBLY**

**REASSEMBLY HINTS AND TIPS**

Upon performing applicable maintenance to the air distribution system, the pump can now be reassembled. Please refer to the disassembly instructions for photos and parts placement.

To reassemble the pump, follow the disassembly instructions in reverse order. The air distribution system needs to be assembled first, then the diaphragms and finally the wetted path. The applicable torque specifications are on this page.

The following tips will assist in the assembly process:

- Lubricate the air valve bore, center section shaft and pilot spool bore with NLGI grade 2 white EP bearing grease or equivalent.
- Clean the inside of the center section shaft bore to ensure no damage is done to new shaft seals.
- A small amount of NLGI grade 2 white EP bearing grease can be applied to the muffler and air valve gaskets to lubricate gaskets during assembly.
- Make sure that the exhaust port on the muffler plate is centered between the two exhaust ports on the center section.
- Stainless-steel bolts should be lubed to reduce the possibility of seizing during tightening.
- Use a mallet to tap lightly on the large clamp bands to seat the diaphragm before tightening.

Maximum Torque Specifications	
Description	Torque
Air Valve	11.3 N.m (100 in-lb)
Dial set screw	11.3 N.m (100 in-lb)
Outer pistons, all diaphragms	47.5 N.m (35 in-lb)
Center block-to-stand bolt	44.7 N.m (33 in-lb)
Center block-to-bushing bolt	44.7 N.m (33 in-lb)
Locking Pin	44.7 N.m (33 in-lb)
Anti-Rotation Bolt	67.8 N.m (50 in-lb)



**NOTE:** To ensure proper alignment during reassembly of manifold/liquid chamber interface, turn off-set portion of valve housing to the left or to the right. This procedure works for the inlet manifold and discharge manifold connections

## DISASSEMBLY / REASSEMBLY

## SHAFT SEAL INSTALLATION

## Pre-Installation

After all the old seals have been removed, the inside of the bushing should be cleaned to ensure no debris is left that may cause premature damage to the new seals.

## Installation

1. To prevent damaging the inside surface of the new seal, wrap electrical tape around each leg of the needle-nose pliers. (Heat shrink tubing may also be used.)
2. With a new seal in hand, place the two legs of the needle-nose pliers inside the seal ring. (See Figure A.)
3. Open the pliers as wide as the seal diameter will allow, then with two fingers pull down on the top portion of the seal to form a kidney bean shape. (See Figure B.)
4. Lightly clamp the pliers together to hold the seal into the kidney shape. Be sure to pull the seal into as tight of a kidney shape as possible. This will allow the seal to travel down the bushing bore with greater ease.
5. With the seal clamped in the pliers, insert the seal into the bushing bore and position the bottom of the seal into the correct groove. When the bottom of the seal is seated in the groove, release the clamp pressure on the pliers. This will allow the seal to partially snap back to its original shape.
6. After removing the pliers, you will notice a slight bump in the seal shape. Before the seal can be resized properly, the bump in the seal should be removed as much as possible. This can be done with either a Phillips screwdriver or your finger. With the side of the screwdriver or your finger, apply light pressure to the peak of the bump. This pressure will cause the bump to be eliminated almost completely.
7. Lubricate the edge of the shaft with NLGI grade 2 white EP bearing grease.
8. Slowly insert the center shaft with a rotating motion. This will complete the resizing of the seal.
9. Repeat these steps for the remaining seals.

## Tools

The following tools can be used to aid in the installation of the new seals:

- Needle-Nose Pliers
- Phillips Screwdriver
- Electrical Tape

Figure A

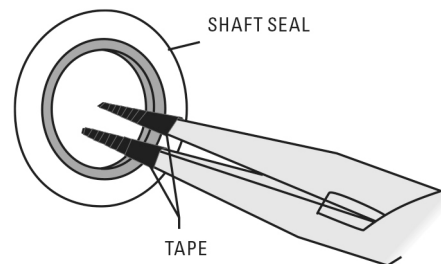
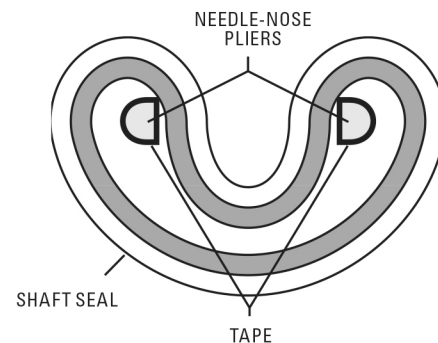

Figure B



## SECTION 8

## CLEAN-IN-PLACE (CIP)

The design of the Saniflo™ Hygienic™ Series pump allows for ease of cleaning. The Saniflo™ Hygienic™ Series pump can be cleaned in place without disassembly. Before any cleaning is attempted, ensure that the cleaning fluids are compatible with all wetted components.

**For best cleaning results consider the following information prior to cleaning the Saniflo™ Hygienic™ Series pump.**

- Actual CIP effectiveness with pump user's product(s) and processes should be validated on location by the end user's quality assurance personnel to meet internal guidelines. Post cleaning swab test is one method to accomplish this.
- The pump user should establish periodic inspections with full tear down to verify that the CIP processes continue to be effective as first validated.
- Liquid inlet pressure to the pump should not be greater than 0.7 bar (10 psig). Premature diaphragm failure may occur if greater than 0.7 bar (10 psig) is applied. If the pump is to be subjected to greater than 0.7 bar (10 psig), an optional diaphragm balancing device is suggested to eliminate the possibility of the diaphragms being forced against the air chamber and subsequently causing premature diaphragm failure.

**The following are some details to consider when cleaning the Saniflo™ Hygienic™ Series pump.**

- The H1500 HS pump has been validated to clean equivalent to the inlet tubing of the same diameter. The cleaning chemical supplier should be consulted and advised of this for their chemical solution and application. The same guideline for duration of cleaning cycle and temperature of cleaning fluid apply.
- Suggested flow rate for the HS1500 HS pump is 100 gpm minimum/22.7 m<sup>3</sup>/hr (usually higher is better).
- Typical CIP temperature is 77°C to 82°C (170°F to 180°F).
- Typical chemicals include NaOH (sodium hydroxide) caustic for wash and light acid and sanitizers for rinse.

- Once an initial CIP regimen is established, it may need to be modified to accommodate specific process and product differences or requirements. The most common adjustments include:
  - Changing cleaning time (extended or reduced pre-rinse, wash, rinses)
  - Changing cleaning flow rate
- The cleaning variables are related so that a pump user may be able to reduce the cleaning time by increasing the flow rate or chemical mix.
- Chlorinated sanitizers are known to cause premature failure of stainless steel and should be avoided.
- Keep in mind, many CIP systems leave the pump filled with sanitizer and water and do not require draining.
- To drain a pump that is fitted with a non-swivel stand, the manifolds and liquid chambers must be removed if there is no automated CIP airblow system in place. With the use of an automated CIP airblow system, a pump fitted with a non-swivel stand can be cleaned in the same manner as a pump fitted with a swivel stand.
- An effective CIP system must have drain valves in the process line before and after the pump at the lowest points. The CIP system must be programmed to alternate between blowing air and opening the drain valves. This process must be repeated several times.

**To Clean Pump**

Activate the CIP system while slowly cycling the pump.

**NOTE:** A typical the CIP temperature limit is 90°C (195°F). If the CIP temperature is greater than 90°C (195°F), damage to the pump may occur.

**SECTION 9**

**EXPLODED VIEW AND PARTS LIST**

**H1500 SANIFLO HYGIENIC SERIES**

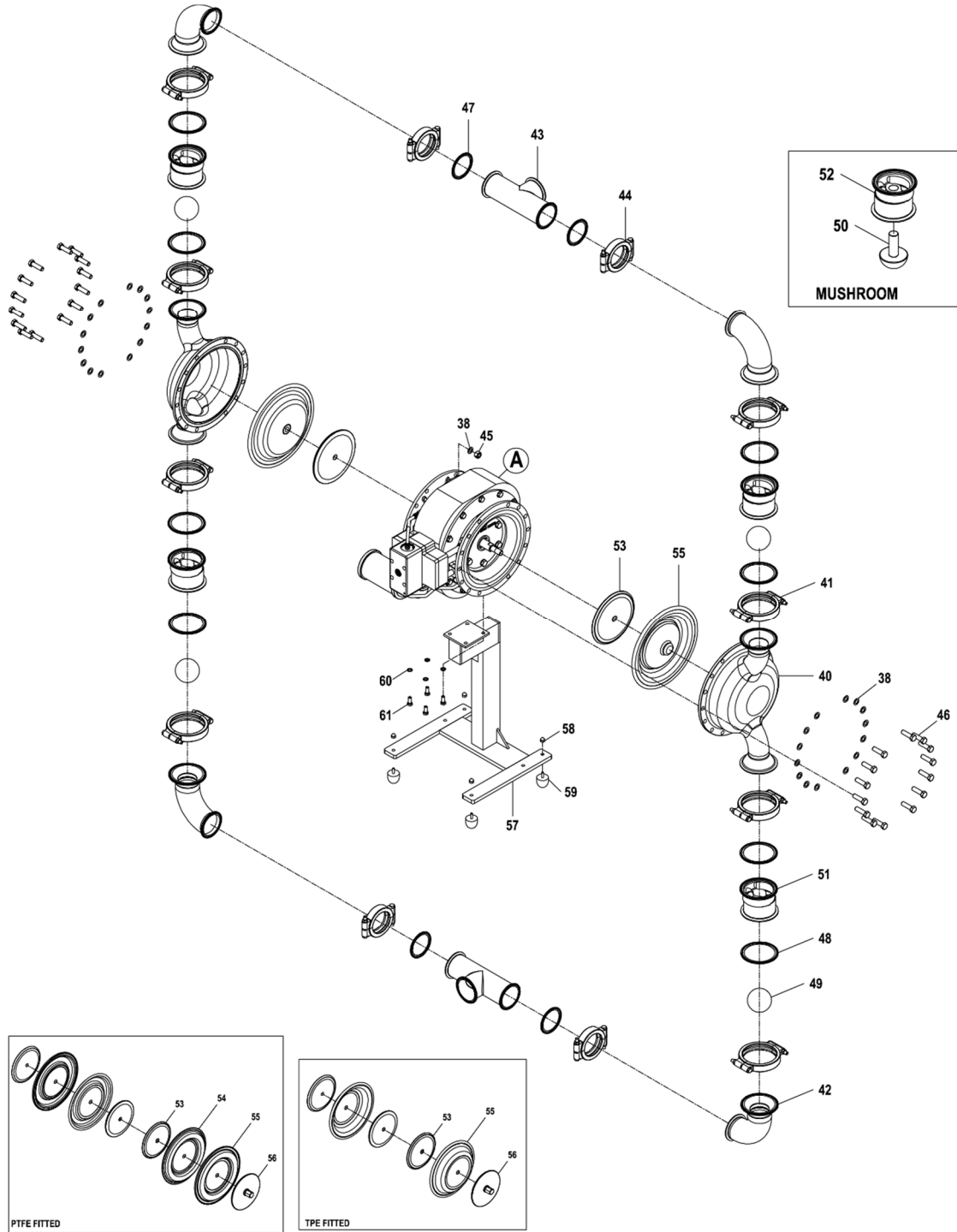

ALL CIRCLED PART IDENTIFIERS ARE INCLUDED IN REPAIR KITS

LW0127 REV. D

**EXPLODED VIEW AND PARTS LIST**

**H1500 – CENTER SECTION**

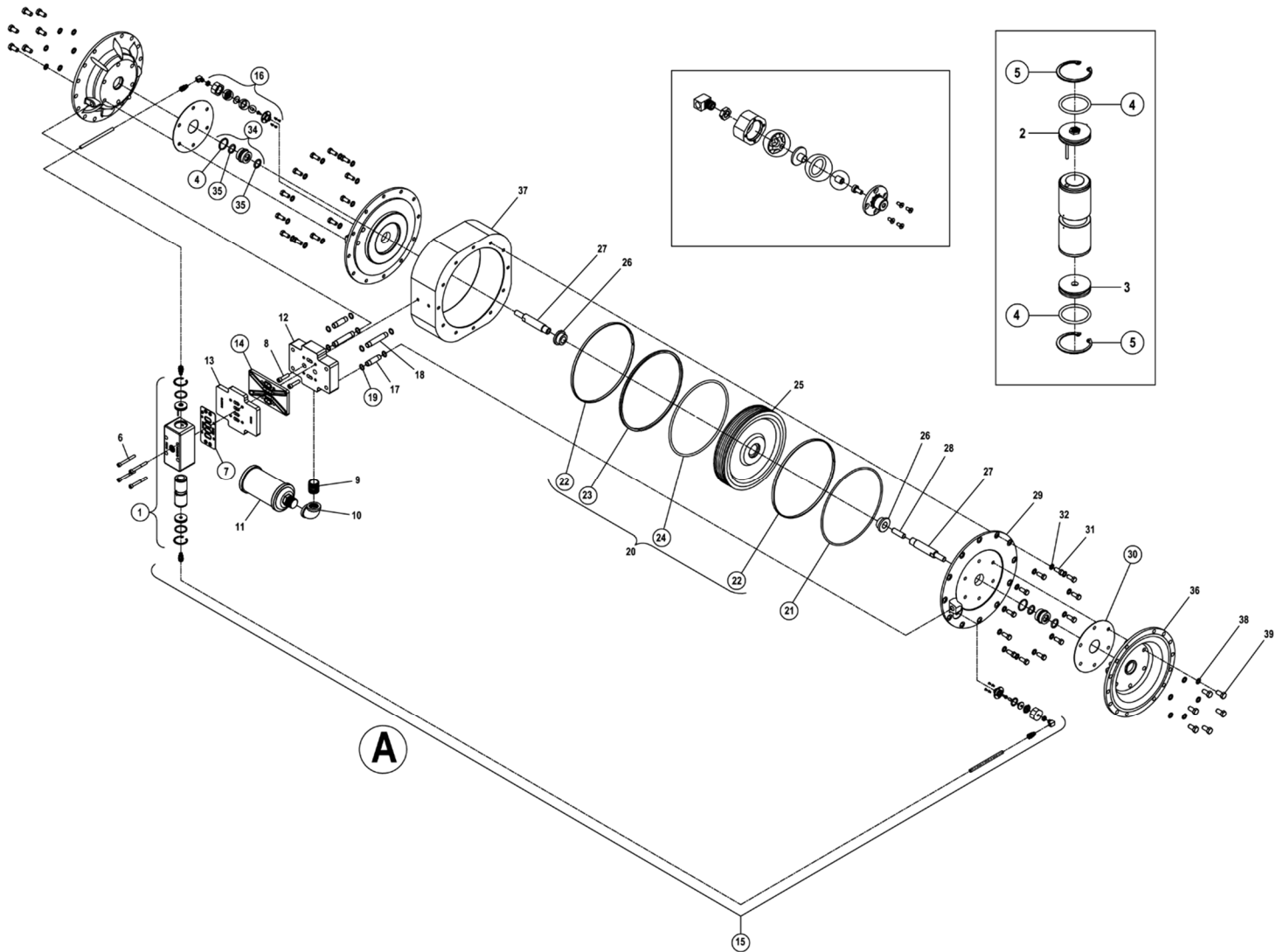

ALL CIRCLED PART IDENTIFIERS ARE INCLUDED IN REPAIR KITS

LW0127 REV. D

**EXPLODED VIEW AND PARTS LIST**

Model Description			H1500/SZSII/...	H1500/SSSII/...
Item	Part Description	Qty,	P/N	P/N
<b>Air Distribution Components</b>				
1	<b>Air Valve Assembly<sup>1</sup></b>	1		<b>08-2003-45</b>
2	End Cap w/Guide Nylon	1		08-2306-23
3	End Cap w/o Guide Nylon	1		08-2336-23
4	<b>O-Ring (-220) (Ø1.359 x Ø.139)</b>	2		<b>15-2390-52</b>
5	Retaining Ring	2		15-2650-03
6	Screw, SHC, Air Valve (5/16"-18 x 2 3/4")	4		08-6000-03-83
7	Air Valve Gasket	1		08-2601-52
8	Screw, SHC, Manifold (3/8"-16 x 1 1/2")	2		99-6034-08
9	Nipple, 1" NPT, Galvanized	1		08-7430-08-60
10	Elbow, 90°, 1" NPT, Galvanized	1		08-7840-08-60
11	Muffler	1		15-3510-99
12	Manifold, Bottom Air Valve	1		08-2700-45
13	Plate, Isolator Cover	1		08-2705-45
14	Gasket, Air Valve Isolator	1		08-2603-52
15	Relief Tube Assembly	2		08-9232-99-60
16	<b>Pressure Relief Valve Assembly</b>	2		<b>08-2742-99-60</b>
	<b>Rebuild Pressure Relief Seal Kit</b>	1		<b>99-9346-99</b>
17	Pipe	2		08-7520-03-60
18	Pipe	2		08-7510-03-60
19	O-Ring (-114) Pipe (Ø.612 x Ø.103)	8		00-2870-52
20	Power Piston Seal Kit <sup>2</sup>	1		08-9210-99-60
21	<b>O-Ring (-379) Cover (Ø10.975 x Ø.210)</b>	2		-
22	Guide Ring, Bronze-Filled	2		-
23	<b>Slipper Seal, PTFE-Filled</b>	1		-
24	<b>O-Ring (-450) Piston (Ø10.475 x Ø.275)</b>	1		-
25	Piston, Cylinder	1		08-3720-01-60
26	Bushing, Cylinder Piston	2		08-3730-03-60
27	Shaft	2		08-3800-03-60
28	Stud, Shaft	1		08-6150-08-60
29	Cover, Center Section	2		08-3000-45-60
30	<b>Gasket, Center Section</b>	2		<b>08-3260-52-60</b>
31	Screw, HHC (7/16"-14 x 1")	24		08-6260-08-60
32	Washer (7/16")	24		08-6830-03-60
33	Pipe Plug, 1/16" NPT	2		08-7030-08-60
34	Bushing, Assembly Center Section <sup>3</sup>	2		08-3300-99-60
35	<b>Glyd Ring</b>	4		<b>15-3210-55-225</b>
	<b>O-Ring (-220) (Ø1.359 x Ø.139) Item No. 4</b>	2		<b>15-2390-52</b>
36	Chamber, Air	2		08-3653-03-60
37	Section, Center	1		08-3158-45-60
38	Washer (1/2")	12		08-6840-03-60
39	Screw, HHC (1/2"-13 x 1")	12		08-6132-08
<b>Wetted Path Components</b>				
▲ 40	Chamber, Liquid CIP 3"	2		15-5012-10-385P
41	Clamp Band Assy, 4"	8		15-7203-03
▲ 42	Elbow, 3"	4		15-5240-10-385P
▲ 43	T-Section, 3"	2		15-5190-10-385P
44	Clamp Band, Assy, 3"	4		15-7103-03
45	Hex Nut, (1/2"-13)	28		15-6420-03
46	Screw, HHC (1/2"-13 x 1 3/4")	28		08-6190-08-60
38	Washer (1/2")	56		08-6840-03-60

Continued on Next Page...

**EXPLODED VIEW AND PARTS LIST**

Model Description		H1500/SZSII/...	H1500/SSSII/...
Item	Part Description	Qty,	P/N
<b>Gaskets/Valve Balls/Mushroom Valve</b>			
▲ 47	<b>Gasket, 3"</b>	4	*
▲ 48	<b>Gasket, 4"</b>	8	*
▲ 49	<b>Valve Ball</b>	4	*
▲ 50	<b>Mushroom Valve</b>	4	<b>15-1096-55</b>
<b>Check Valve Components</b>			
▲ 51	Ball Cage, 3"	4	15-5350-10-385P
▲ 52	Mushroom Valve Housing	4	15-5431-10-385P
<b>FSIPD Components</b>			
53	Piston, Inner, (Non-PTFE)	2	08-3700-03
▲ 55	<b>Diaphragm, Full Stroke IPD, Primary</b>	2	<b>08-1032-57</b>
<b>TPE Components</b>			
53	Piston, Inner, (Non-PTFE)	2	08-3700-03
▲ 55	<b>Diaphragm, Primary</b>	2	<b>08-1011-57</b>
▲ 56	Piston, Outer, (Non-PTFE)	2	08-4550-10-385P
<b>PTFE Components</b>			
53	Piston, Inner, (Non-PTFE)	2	08-3700-03
54	<b>Diaphragm, Full Stroke PTFE, Back-up</b>	2	<b>08-1065-57</b>
▲ 55	<b>Diaphragm, Full Stroke PTFE, Primary</b>	2	<b>08-1040-55</b>
▲ 56	Piston, Outer, (Non-PTFE)	2	08-4550-10-385P
<b>Fixed Stand Components</b>			
57	Stand, Pump, PV Assy. <sup>4</sup>	1	15-7653-10-385
58	Nut, Cap, 5/16"-18, Pump Stand	4	08-6600-03-72
59	Pad, Pump Stand	4	08-7670-20
60	Washer, Flat (Ø.390 X Ø.625 X .063)	4	02-6730-03
61	Screw, HHC, 3/8"-16 X 7/8"	4	08-6140-03

LW0167 Rev. C

\* See elastomer chart - Section 9

<sup>1</sup> Air Valve Assembly includes items 2, 3, 4, and 5.

<sup>2</sup> Power Piston Seal Kit includes item numbers 21, 22, 23, and 24.

<sup>3</sup> Bushing Assembly, Center Section, includes qty. 1 of item 34 and 4.

<sup>4</sup> Stand Assembly includes item numbers 58 and 59.

▲ Product Contact Components

All boldface items are primary wear parts.

**SECTION 10**

**ELASTOMER OPTIONS**

MATERIAL	DIAPHRAGMS (2)	FULL-STROKE DIAPHRAGMS (2)	BACK UP DIAPHRAGMS FULL-STROKE (2)	FULL-STROKE IPD DIAPHRAGMS (2)	VALVE BALL (4)	GASKET, 3" (4)	GASKET, 4" (8)
FDA EPDM						15-1375-74	15-1215-74
PTFE		08-1011-55			15-1086-55	15-1375-55	15-1215-55
FDA WIL-FLEX™	08-1011-57		08-1067-57	08-1032-57	15-1086-57		
FDA FKM						15-1375-68	15-1215-68

LW0167 Rev. C

**WILDEN®**

PSG  
22069 Van Buren Street  
Grand Terrace, CA 92313-5651 USA  
P: +1 (909) 422 -1730  
psgdover.com



Where Innovation Flows

---

Copyright 2021 PSG®, a Dover® Company  
PSG® reserves the right to modify the information and illustrations contained in this document without prior notice. This is a non-contractual document.