

## Self-Priming Centrifugal Pumps

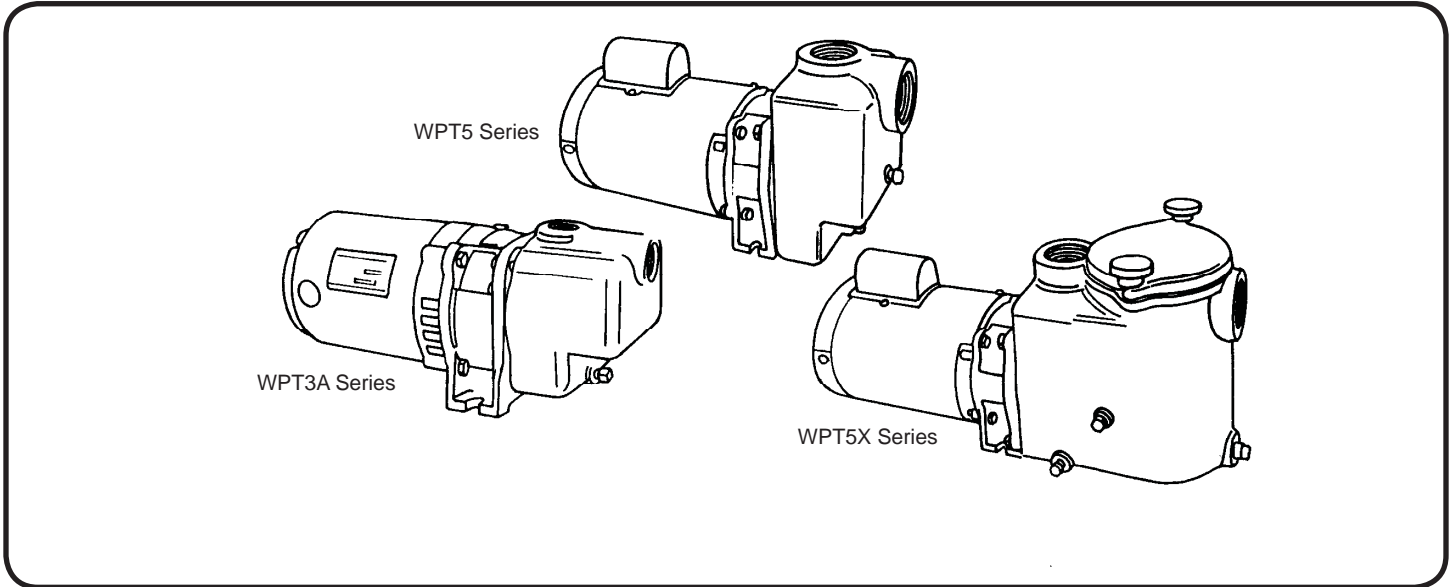

60 HZ - PERFORMANCE AND SELECTION 1.62 SG FLUID - 3500 RPM																	
Catalog No. **	Catalog No. w/ Strainer**	HP	Tappings			GPM Capacity at Head Shown											
			Suct. (in)	Disch. (in)	PSI Feet	10 14	15 21	20 28	25 36	30 43	35 50	40 57	45 64	50 71	55 78	60 86	65 93
*A3WPT3A	Not Available	1/2	1	1		41	37	29	15	---	---	---	---	---	---	---	---
*3WPT3A	Not Available	1/3	1	1		41	37	29	15	---	---	---	---	---	---	---	---
5WPT5	5WPT5X	1/2	2	2		38	36	32	26	19	10	---	---	---	---	---	---
7WPT5	7WPT5X	3/4	2	2		50	47	43	38	32	26	18	10	---	---	---	---
10WPT5	10WPT5X	1	2	2		62	58	55	50	43	36	28	20	10	---	---	---
15WPT5	15WPT5X	1½	2	2		73	71	68	64	58	53	44	34	23	12	---	---
20WPT5	20WPT5X	2	2	2		82	80	78	74	70	66	57	48	37	24	9	---
30WPT5	30WPT5X	3	2	2		94	92	90	90	87	84	80	74	66	55	40	20
30WPT5A	30WPT5AX	3	2	2		144	140	136	127	115	100	80	44	---	---	---	---

Catalog No. **	Catalog No. w/ Strainer**	HP	Tappings			LPS Capacity at Head Shown											
			Suct. (in)	Disch. (in)	KPA Meters	69 4.2	103 6.4	137 8.5	172 10.9	206 13.1	241 15.2	275 17.3	310 19.5	344 21.6	379 23.7	413 26.2	448 28.3
*A3WPT3A	Not Available	1/2	1	1		2.5	2.3	1.8	0.9	---	---	---	---	---	---	---	---
*3WPT3A	Not Available	1/3	1	1		2.5	2.3	1.8	0.9	---	---	---	---	---	---	---	---
5WPT5	5WPT5X	1/2	2	2		2.3	2.2	2.0	1.6	1.1	0.6	---	---	---	---	---	---
7WPT5	7WPT5X	3/4	2	2		3.1	2.9	2.7	2.3	2.0	1.6	1.1	0.6	---	---	---	---
10WPT5	10WPT5X	1	2	2		3.9	3.6	3.4	3.1	2.7	2.2	1.7	1.2	0.6	---	---	---
15WPT5	15WPT5X	1½	2	2		4.6	4.4	4.2	4.0	3.6	3.3	2.7	2.1	1.4	0.7	---	---
20WPT5	20WPT5X	2	2	2		5.1	5.0	4.9	4.6	4.4	4.1	3.5	3.0	2.3	1.5	0.5	---
30WPT5	30WPT5X	3	2	2		5.9	5.8	5.6	5.6	5.4	5.2	5.0	4.6	4.1	3.4	2.5	1.2
30WPT5A	30WPT5AX	3	2	2		9.0	8.8	8.5	8.0	7.2	6.3	5.0	2.7	---	---	---	---

(\*\*) Catalog numbers are for units with single phase motors. For three phase, add prefix, "3". Example: 35WPT5X.

(\*) Maximum suction lift on WPT3A - 7ft.

# Series: WPT

For Perchloroethylene and Other 1.62 S.G. Fluids  
3500 RPM - 60 Hz.



## Self-Priming Centrifugal Pumps

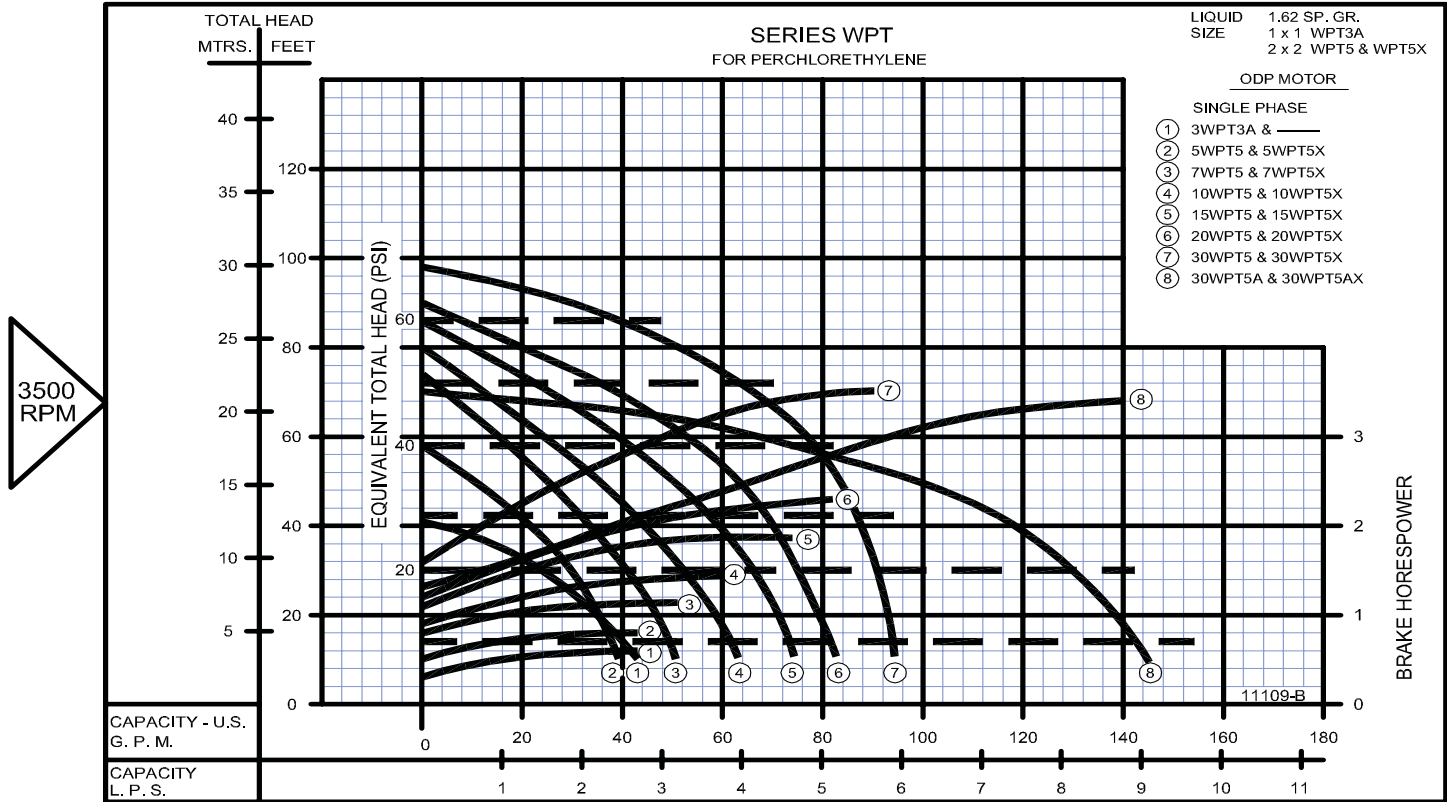

- Compact, Close-Coupled Design
- Rugged Bronze-Fitted Cast Iron Construction
- Leakproof Mechanical Shaft Seal
- Non-Clogging, Bronze Semi-Open Impeller
- Stainless Steel Shaft
- Back Pull-Out Design For Easy Servicing
- Available With or Without Built-In Basket Type Strainer
- Self-Priming, Once Case is Filled With Fluid
- Diaphragms, Flappers or Check Valves Are Not Required In Pump Suction Piping. But Are Recommended
- EVERY pump is factory tested and will meet Hydraulic Institute standards.

### MOTOR INFORMATION

WPT3A Series have NEMA Jet Pump Motors. WPT5 & WPT5X Series have rugged Swimming Pool type motors with oversize ball/ball bearing construction. All motors have open-drip proof construction and are rated with standard NEMA Jet Pump service factors for continuous duty operation at all ratings shown. Voltages may differ from some suppliers. Consult factory.

Overload Protection: All single phase motors have built-in thermal overload protection. All three phase motors must be installed with a magnetic starter which provides full 3-leg protection. Failure to use correct starter and overloads will void motor warranty. All Single Phase Open Drip Proof Motors Are U.L. Recognized.

### RATINGS

A3WPT3A-1/3 HP, Single Phase, 115V, 60Hz, 3500RPM, ODP, Split Phase.

3WPT3A-1/3 HP, Single Phase, 115/230V, 60Hz, 3500RPM, ODP, Capacitor Start.

33WPT3A-1/3 HP, Three Phase, 230/460V, 60Hz, 3500RPM, ODP

WPT5 & WPT5X Series: Single Phase: 1/2 thru 2HP, 115/230V, 60HZ, 3500RPM, ODP, Capacitor Start. 3HP is 230V only.

Three Phase: 1/2 thru 3HP, 230/460V, 60HZ, 3500RPM, ODP.

### MAXIMUM OPERATING CONDITIONS

TEMPERATURE (For Standard Buna-N Seal)	225°F (107°C)
INLET PRESSURE (WPT3 & WPT5)	100 PSI (689kPa)
INLET PRESSURE (WPT5X)	15 PSI (103kPa)
CASING WORKING PRESSURE (WPT3 & WPT5)	165 PSI (1137kPa)
CASING WORKING PRESSURE (WPT5X)	60 PSI (413kPa)

### MATERIALS OF CONSTRUCTION

PART	CAST IRON	BRONZE FITTED
Adapter	Cast Iron	Cast Iron
Case	Cast Iron	Cast Iron
Diffuser	Cast Iron	Cast Iron
Impeller	Cast Iron	Bronze
Shaft	Stainless	Stainless
Shaft Seal	Carbon-Ceramic SS - Viton	
Suction Sleeve	Viton	Viton
Strainer Gasket	Viton	Viton
Strainer Basket	Stainless	Stainless
All Plugs	Brass	Brass

SECTION 4C  
PAGE 6  
DATE 4/08



PUMPS & SYSTEMS

A Crane Co. Company

USA: (937) 778-8947 • Canada: (905) 457-6223 • International: (937) 615-3598

### Self-Priming Centrifugal Pumps

#### SERIES: WPT3A

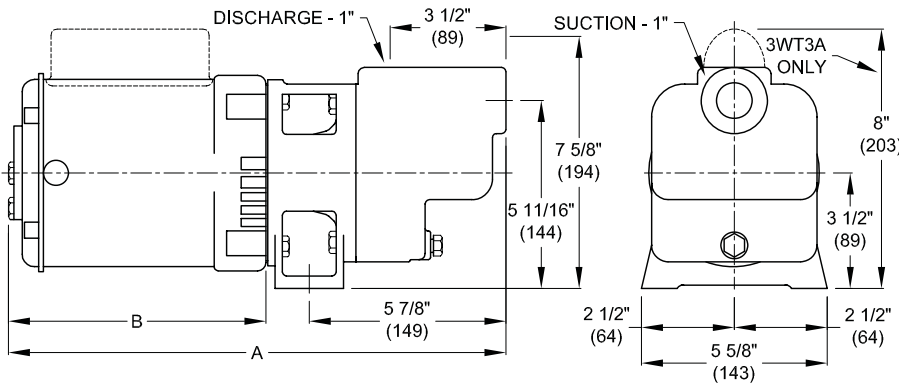

DIMENSIONS IN INCHES				
CATALOG NUMBER	SINGLE PHASE		THREE PHASE	
	A	B	A	B
A3WPT3A	15	7 <sup>7</sup> / <sub>8</sub>	---	---
3WPT3A	15 <sup>1</sup> / <sub>2</sub>	8 <sup>3</sup> / <sub>8</sub>	---	---
33WPT3A	---	---	15 <sup>1</sup> / <sub>2</sub>	8 <sup>3</sup> / <sub>8</sub>

DIMENSIONS IN MILLIMETERS				
CATALOG NUMBER	SINGLE PHASE		THREE PHASE	
	A	B	A	B
A3WPT3A	381	200	---	---
3WPT3A	393	212	---	---
33WPT3A	---	---	393	212

All models have 1" NPT suction and discharge.

#### SERIES: WPT5

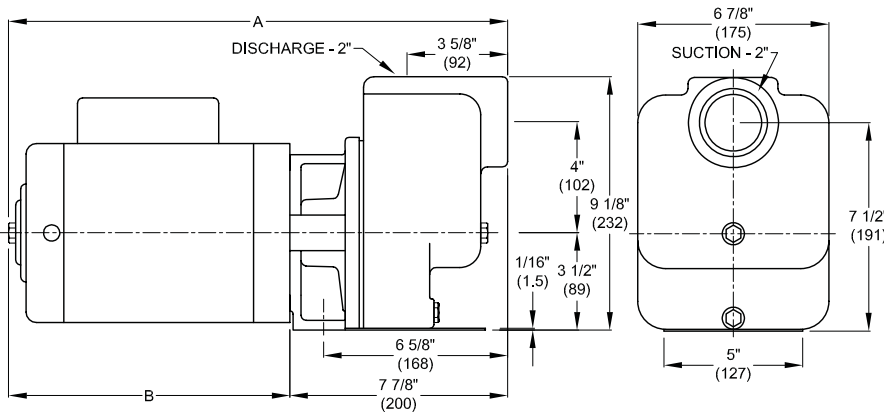

DIMENSIONS IN INCHES				
CATALOG NUMBER	SINGLE PHASE		THREE PHASE	
	A	B	A	B
5WPT5	15 <sup>7</sup> / <sub>8</sub>	8	15 <sup>5</sup> / <sub>8</sub>	7 <sup>3</sup> / <sub>4</sub>
7WPT5	16 <sup>7</sup> / <sub>8</sub>	9	16 <sup>7</sup> / <sub>8</sub>	9
10WPT5	17 <sup>1</sup> / <sub>4</sub>	9 <sup>3</sup> / <sub>8</sub>	16 <sup>7</sup> / <sub>8</sub>	9
15WPT5	18	10 <sup>1</sup> / <sub>8</sub>	16 <sup>7</sup> / <sub>8</sub>	9
20WPT5	18	10 <sup>1</sup> / <sub>8</sub>	17 <sup>1</sup> / <sub>4</sub>	9 <sup>3</sup> / <sub>8</sub>
20WPT5A	18	10 <sup>1</sup> / <sub>8</sub>	17 <sup>1</sup> / <sub>4</sub>	9 <sup>3</sup> / <sub>8</sub>

DIMENSIONS IN MILLIMETERS				
CATALOG NUMBER	SINGLE PHASE		THREE PHASE	
	A	B	A	B
5WPT5	403	203	396	196
7WPT5	428	228	428	228
10WPT5	438	238	428	228
15WPT5	457	257	428	228
20WPT5	457	257	438	238
20WPT5A	457	257	438	238

All models have 2" NPT suction and discharge.

#### SERIES: WPT5X

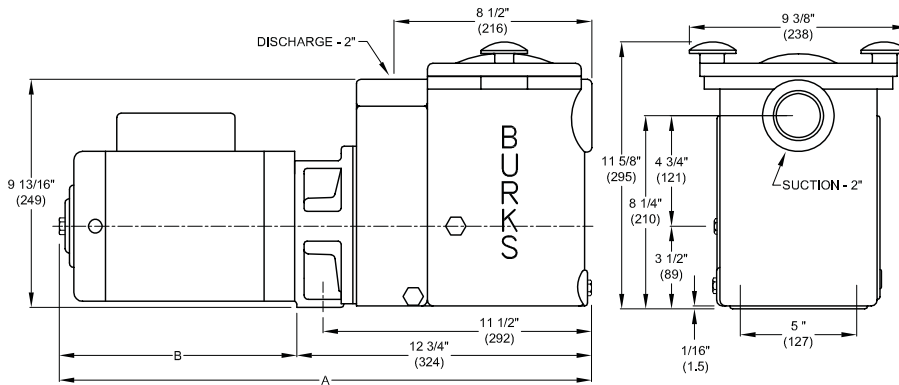

DIMENSIONS IN INCHES				
CATALOG NUMBER	SINGLE PHASE		THREE PHASE	
	A	B	A	B
5WPT5X	20 <sup>3</sup> / <sub>4</sub>	8	20 <sup>1</sup> / <sub>2</sub>	7 <sup>3</sup> / <sub>4</sub>
7WPT5X	21 <sup>1</sup> / <sub>4</sub>	9	21 <sup>1</sup> / <sub>4</sub>	9
10WPT5X	22 <sup>3</sup> / <sub>8</sub>	9 <sup>3</sup> / <sub>8</sub>	21 <sup>1</sup> / <sub>4</sub>	9
15WPT5X	22 <sup>7</sup> / <sub>8</sub>	10 <sup>1</sup> / <sub>8</sub>	21 <sup>1</sup> / <sub>4</sub>	9
20WPT5X	22 <sup>7</sup> / <sub>8</sub>	10 <sup>1</sup> / <sub>8</sub>	22 <sup>1</sup> / <sub>8</sub>	9 <sup>3</sup> / <sub>8</sub>
20WPT5AX	22 <sup>7</sup> / <sub>8</sub>	10 <sup>1</sup> / <sub>8</sub>	22 <sup>1</sup> / <sub>8</sub>	9 <sup>3</sup> / <sub>8</sub>

DIMENSIONS IN MILLIMETERS				
CATALOG NUMBER	SINGLE PHASE		THREE PHASE	
	A	B	A	B
5WPT5X	527	203	520	196
7WPT5X	552	228	552	228
10WPT5X	561	238	552	228
15WPT5X	581	257	552	228
20WPT5X	581	257	561	238
20WPT5AX	581	257	561	238

All models have 2" NPT suction and discharge.

**DO NOT USE FOR CONSTRUCTION PURPOSES. CERTIFIED DRAWINGS AVAILABLE ON REQUEST**