

SP

Submersible pumps, motors, and accessories
North America, 60 Hz



be
think
innovate



1. Product data	3	7. Electrical data	106
Introduction	3		
Pump Energy Index	3	8. Approvals	108
Applications	4		
Features and benefits	4	9. Accessories	109
Performance range 60 Hz	10	Grundfos RSI	
Pump range	11	(Renewable Solar Inverter)	109
Motor protection and controllers range	11	CU331SP variable frequency drive	111
Identification	12	CU331SP installation	117
		CU331SP electrical connection	118
2. Construction	14	CU331SP technical data	124
Sectional drawing, SP pump		CUE variable frequency drive	134
4" spline shaft (SP 5S - 25S)	14	MP 204	136
Sectional drawing, SP pump		Connecting pieces	141
4" smooth shaft (SP 35S - 77S)	15	Zinc anodes	142
Sectional drawing, SP pump		SA-SPM 6 control boxes	143
6" (SP 85S - 300S)	16	Pt100/Pt1000	144
Sectional drawing, SP pump			
8" (SP 385S - 475S)	17	10. Energy consumption	146
Sectional drawing, SP pump		Energy consumption of submersible pumps	146
10" (SP 625S - 1100S)	18		
Sectional drawing, MS motors	19	11. Cables	147
Sectional drawing, MMS motors	20	Cable sizing charts	147
3. Operating conditions	21	12. Friction loss tables	152
Operating conditions	21		
		13. Grundfos Product Center	154
4. Selection	22		
5S - 25S easy selection charts	22		
5. Performance curves and technical data	27		
How to read the curve charts	27		
Curve conditions	28		
6. Curve charts and technical data	29		
4" and larger wells	29		
SP 5S (5 gpm)	29		
SP 7S (7 gpm)	31		
SP 10S (10 gpm)	33		
SP 16S (16 gpm)	35		
SP 25S (25 gpm)	37		
SP 35S (35 gpm)	39		
SP 45S (45 gpm)	44		
SP 62S (62 gpm)	49		
SP 77S (77 gpm)	53		
6" and larger wells	57		
SP 85S (85 gpm)	57		
SP 150S (150 gpm)	63		
6" and larger wells - continued	66		
SP 230S (230 gpm)	69		
SP 300S (300 gpm)	75		
8" and larger wells	81		
SP 385S (385 gpm)	81		
SP 475S (475 gpm)	86		
10" and larger wells	91		
SP 625S (625 gpm)	91		
SP 800S (800 gpm)	96		
SP 1100S (1100 gpm)	101		

1. Product data

Introduction

The Grundfos SP range of submersible pumps is renowned for high efficiency and reliability. SP pumps are ideal for a wide variety of applications and are made entirely of corrosion resistant stainless steel.

Grundfos SP pumps represent state-of-the-art hydraulic design. SP pumps are built to deliver optimum efficiency during periods of high demand, and they provide low long-term costs and high operating reliability regardless of the application.

The SP range offers high efficiency, high resistance to sand and other abrasives, motor burnout protection, and easy maintenance. A complete monitoring and control system is available for constant optimization of the pumping system.



Fig. 1 Grundfos SP pumps

TM06 4950 3315

Pump Energy Index

Pump Energy Index (PEI) was established by the U.S. Department of Energy (DOE) and adopted by Canada as the standard metric used to evaluate pump efficiency. The value is the ratio of the pump efficiency rating (PER) divided by the calculated minimally compliant PER (PER_{STD}) for the pump type. This provides a representation of a pump's actual performance compared to the minimal standard performance required by regulation. The lower the PEI value, the more efficient a pump is at the tested operating points.

PER is determined by defined testing parameters required by the DOE. This includes testing a particular pump model at its best efficiency point (BEP).

For PEI values there are two different versions:

- PEI_{CL} (constant load): Applies to a bare-shaft pump, and a pump sold with a motor
- PEI_{VL} (variable load): Applies to pumps sold with a motor and controller (such as VFD, VSD)

The DOE has set the maximum PEI value as 1.00. Any pump, pump and motor, or pump, motor and controller that exceeds a PEI value of 1.00 can no longer be manufactured after January 26, 2020.

PEI is a generalized efficiency value. PEI cannot be used to determine the efficiency of a pump in a specific application.

Pump type	Pole	PEI_{CL} bare-shaft pump	PEI_{CL} pump with motor	PEI_{VL} pump with motor plus controller*	Impeller diameter [in (mm)]
25S		0.93	0.93	0.59	2.87 (72)
35S		0.85	0.87	0.54	2.88 (73)
45S		0.84	0.84	0.54	2.87 (72)
62S		0.88	0.88	0.54	2.78 (71)
77S	2	0.89	0.91	0.54	2.78 (71)
85S		0.82	0.85	0.52	3.49 (89)
150S		0.91	0.91	0.56	3.52 (89)
230S		0.92	0.92	0.54	3.87 (98)
300S		0.92	0.92	0.53	3.90 (99)

*Grundfos CUE continuous controls.

Applications

Grundfos large SP submersible pumps are suitable for:

- Groundwater supply to waterworks
- irrigation in horticulture and agriculture
- groundwater lowering (dewatering)
- pressure boosting
- industrial applications
- domestic water supply.

Pumped liquids

Grundfos SP pumps are suitable for pumping clean, thin, non-aggressive liquids without solid particles or fibers.

SP offers stainless steel construction which ensures good wear resistance and a reduced risk of corrosion where the water has minor chloride content.

Optional, upgraded stainless steel construction is available for pumping more aggressive liquids:

- A complete range of zinc anodes for cathodic protection is available. See page [142](#) for applications, for example, sea water applications.
- For slightly polluted liquids, such as containing oil, Grundfos offers a complete range of stainless steel SP NE pumps with all rubber parts made of FKM.

Features and benefits

Grundfos SP submersible pumps offer these features and benefits:

- State-of-the-art hydraulics provide high efficiency and low operating costs
- 100 % stainless steel components inside and outside for long service life
- sand resistant
- resistant to aggressive water
- dry-running protection
- monitoring, protection and communication via
 - protection unit MP 204
 - Grundfos GO.

A wide pump range

Grundfos offers energy-efficient SP submersible pumps with a performance range of up to 1,400 gpm (318 m³/h) and 2,100 ft (640 m) of head.

The pump range consists of many pump sizes, and each pump size is available with an optional number of stages to match any duty point.

High pump efficiency

Often pump efficiency is given less consideration than the price of a pump; however, owners who choose efficiency will find substantial savings in energy costs over time. See fig. 2 for an illustration of SP efficiencies in relation to flow rate.

Example

For example, a pump and motor with a 10 % higher efficiency than a cheaper, less efficient pump, can save its owner more than \$80,000 over 10 years*.

* If producing 880 gpm at 325 ft of head for 10 years at 13.8 cents per kWh. U.S. kWh costs range from 6 cents to more than 20 cents, depending on region.

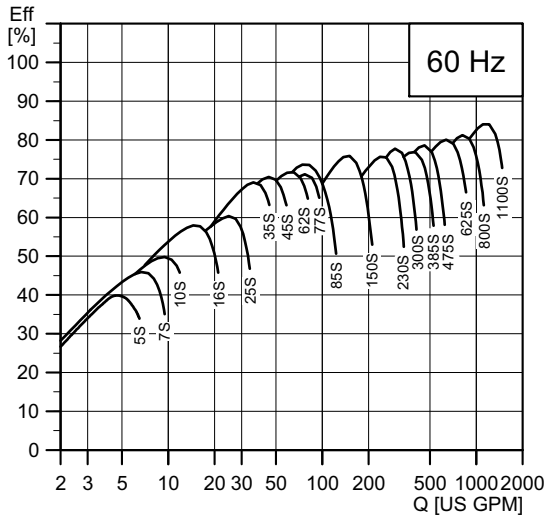

Fig. 2 SP pump and motor efficiencies in relation to flow rate

TM05 0057 3215

Pump design

Grundfos SP submersible pumps feature components that contribute to the superior performance and durability of the range.

Lower installation costs

Stainless steel means low weight for ease in the handling of pumps, resulting in lower equipment costs and reduced installation and service time.

Bearings with sand channels

All bearings are water-lubricated and have a squared shape enabling sand particles, if any, to leave the pump together with the pumped liquid.



Fig. 3 Bearing

TM00 7301 1096

Inlet strainer

The inlet strainer prevents particles over a certain size from entering the pump.



Fig. 4 Inlet strainer

TM00 7302 1096

Check valve

All pumps are equipped with a reliable check valve in the valve casing preventing back flow in connection with pump stoppage.

Furthermore, the short closing time of the check valve means that the risk of destructive water hammer is reduced to a minimum.

The valve casing is designed for optimum hydraulic properties to minimize the pressure loss across the valve and thus to contribute to the high efficiency of the pump.

Note: As shown in fig. 5 the check valve is spring-assisted intended for vertical pump applications. When installing pump at an angle, installation requires an additional check valve installed in the outlet piping. This prevents misalignment or failure to seat the pump check valve at an angle. Additional check valves in outlet piping are sold separately.

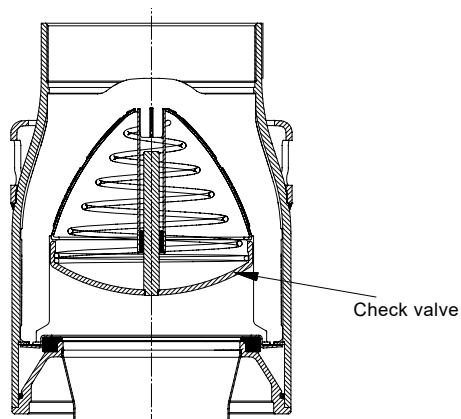

Fig. 5 Check valve

TM01 2499 1798

Priming screw

All Grundfos 4" pumps with radial impellers are fitted with a priming screw. Consequently, dry running is prevented because the priming screw will make sure that pump bearings are always lubricated.

Due to the semi-axial impellers of large SP pumps, this priming is provided automatically.

However, it applies to all pump types that if the water table is lowered to a level below the pump inlet, neither pump nor motor will be protected against dry running.

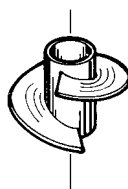

Fig. 6 Priming screw

TM00 7304 1096

Stop ring

The stop ring prevents damage to the pump during transport and in case of up-thrust in connection with startup.

The stop ring, which is designed as a thrust bearing, limits axial movements of the pump shaft.

Example: SP 385S

The stationary part of the stop ring (A) is secured in the upper intermediate chamber.

The rotating part (B) is fitted above the split cone (C).

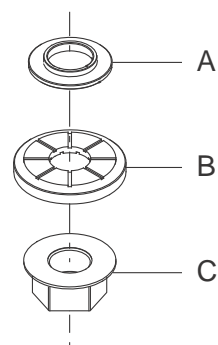

Fig. 7 Stop ring (rotating and stationary part) and the split cone

TM01 3327 0412

Grundfos submersible motors

A complete motor range

Grundfos offers a complete submersible motor range in different voltages. For an overview of motor types, sizes and voltages, see page 106.

- MS 402 is designed for the domestic ground water market and covers outputs.
- The MS 4000 and MS 6000C series are designed for use in a variety of applications in water supply. When equipped with features like oversized motor, temperature measurement, cooling jacket, and SiC/SiC mechanical shaft seals, these motors are suitable for heavy-duty industrial applications, such as dewatering operations.

As a standard, all external surfaces of Grundfos MS motors in contact with water are made of AISI 304 stainless steel. For aggressive water, such as seawater or brackish water, R versions made of AISI 904L are available.

Grundfos rewindable MMS motor range

Grundfos MMS motors are suitable for any submersible installation, including heavy-duty industrial applications and dewatering operations (when equipped with temperature control, oversized motor, cooling jacket, and SiC/SiC mechanical shaft seals).

As standard MMS motors are supplied with black cast-iron end-bells. Optionally, the range is available in all-stainless steel AISI 316 or AISI 904L versions.

The 2-pole Grundfos MMS submersible motors are all easy to rewind. The windings of the stator are made of a special waterproof wire of pure electrolytic copper sheathed with special non-hydroscopic thermoplastic material. The fine dielectric properties of this material allow direct contact between the windings and the liquid for efficient cooling of the windings.



Fig. 8 Grundfos MS motors

TM00 7305 1096 - Gr/A4011 - Gr/A4013



TM03 3478 0406

Fig. 9 Grundfos MMS motors

Industrial submersible motors and MS 6000C T60 versions

For heavy-duty applications Grundfos offers a complete motor range of industrial motors with up to 5 % higher efficiency than that of Grundfos' standard motors.

The cooling of the motor is very efficient due to the large motor surface. The efficient cooling makes it possible to increase the liquid temperature on T60 motors to 140 °F (60 °C) at a minimum flow rate of 3.3 fps (1.0 m/s) past the motor.

The industrial motors are for customers who value low operating costs and long life higher than price.

Grundfos industrial motors are developed for difficult operating conditions. These motors will stand a higher thermal load than standard motors and thus have a longer life when subjected to high load. This applies whether the high load is caused by bad power supply, hot water, bad cooling conditions, high pump load etc. Please note that heavy duty motors are longer than motors for standard conditions.

Overtemperature protection

Accessories for protection against overtemperature are available for both Grundfos MS and MMS submersible motors. When the temperature becomes too high, the protection device will cut out so damage to the pump and motor can be avoided.

Restart of the motor after cut-out can be achieved in two ways:

- manual restart
- automatic restart.

Automatic restart means that MP 204 attempts to restart the motor after 15 minutes. If the first attempt is not successful, restarting will be reattempted at 30-minute intervals.

MS: The Grundfos MS submersible motors (with the exception of MS 402) are available with a built-in Tempcon temperature transmitter for protection against overtemperature. By means of the transmitter, it is possible to read out and/or monitor the motor temperature via an MP 204.

The Grundfos MS 402, MS 4000, and MS 6000C submersible motors can be fitted with a Pt100/Pt1000. Pt100/Pt1000 is fitted in the motor and connected directly to MP 204 or monitored by the PR 5714 relay.

MMS: For the protection of the Grundfos MMS submersible motors against overtemperature, Grundfos offers the Pt100/Pt1000 temperature sensor as an optional extra.

Pt100/Pt1000 is fitted in the motor and connected directly to MP 204 or monitored by the PR 5714 relay.

Protection against upthrust

In case of a very low counter pressure in connection with startup, there is a risk that the entire chamber stack may rise. This is called upthrust. Upthrust may damage both pump and motor. Grundfos pumps and motors are protected against upthrust as standard, preventing upthrust from occurring during the critical startup phase. The protection consists of either a built-in stop ring or hydraulic balancing.

Built-in cooling chambers

In all Grundfos MS submersible motors, efficient cooling is ensured by cooling chambers at the top and at the bottom of the motor, and by an internal circulation of motor liquid. See fig. 10.

As long as the required flow velocity past the motor is maintained, cooling of the motor will be efficient.

Lightning protection

The smallest Grundfos submersible motors, such as MS 402, are all insulated in order to minimize the risk of motor burnout caused by lightning strike.

Reduced risk of short-circuit

The embedded stator winding in the Grundfos MS submersible motor is hermetically enclosed in stainless steel. The result is high mechanical stability and optimum cooling. Also, this eliminates the risk of short-circuit of the windings caused by water condensation.

Shaft seal

MS 402

The shaft seal is of the lip seal type characterized by low friction against the rotor shaft.

The rubber material offers good wear resistance, good elasticity and resistance to particles, and it is approved for use in drinking water.

MS 4000

Ceramic/carbon materials provide the MS shaft seals with optimum sealing, optimum wear resistance and long life.

MS 6000C

The MS 6000C shaft seal material is SiC/SiC. The spring loaded shaft seal is designed with a large surface and a sand shield. The result is a minimum exchange of pumped and motor liquids and no penetration of particles.

Motors, version R, are supplied with a SiC/SiC shaft seal. Other combinations are available on request. See figs 10 and 11 for an illustration of shaft seal components and configuration.

MMS rewindable motors

The standard shaft seal is a SiC/SiC mechanical shaft seal. The shaft seal is replaceable.

The material features good wear resistance and resistance to particles.

Together with the shaft seal housing, the sand shield forms a labyrinth seal, which during normal operating conditions prevents penetration of sand particles into the shaft seal.

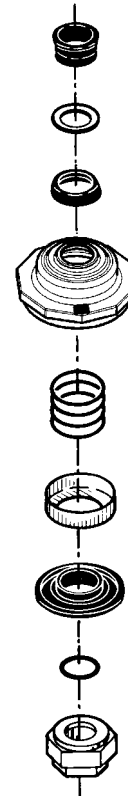

Fig. 10 Shaft seal, MS 4000

TM00 7306 04.12

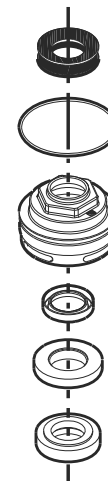
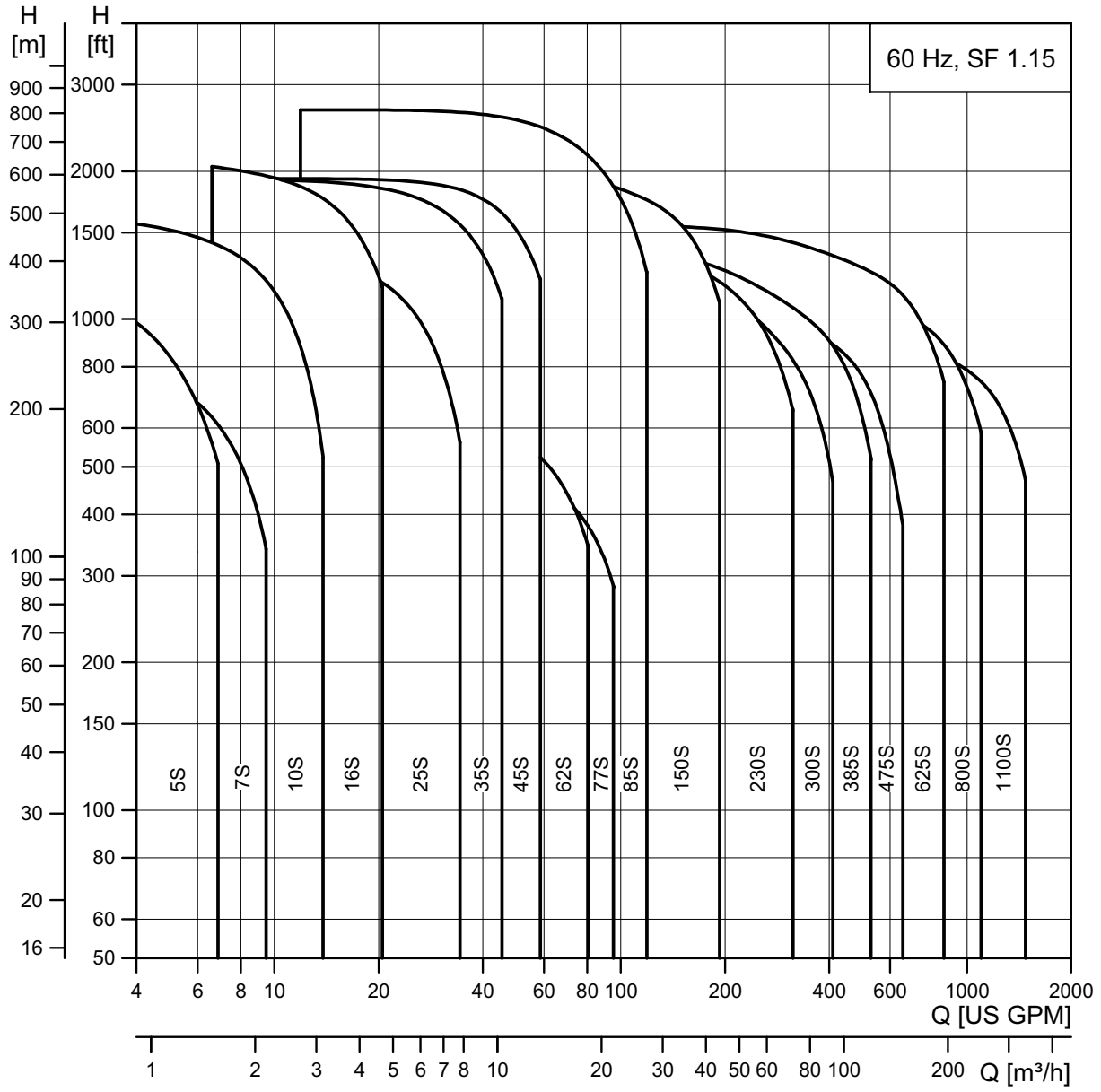

Fig. 11 Shaft seal, MS 6000C

TM03 9225 36.07

Performance range 60 Hz



TM05 0056 3215

Pump range

Type		5S	10S	16S	25S	35S	45S	62S	77S	85S	150S	230S	300S	385S	475S	625S	800S	1100S
AISI 304 (EN 1.4301) stainless steel		•	•	•	•	•	•	•	•	•	•	•	•	•	•	•	•	•
AISI 316 (EN 1.4401) stainless steel				•	•	•	•	•	•	•	•	•	•	•	•	•	•	•
AISI 904L (EN 1.4539) stainless steel					•	•	•	•	•	•	•	•	•	•	•	•	•	•
Connection ★	NPT	1"	1.25"	1.25"	1.5"	1.5" (2")	2" (2")	2"	2"	(3")	(3")	3" (4")	3" (4")	4"	6"	6"	6"	6"
Flange connection: Grundfos flange														4"	6"	6"	6"	6"

★ Figures in brackets () indicate connection for pumps including sleeve and male thread.

Motor protection and controllers range

Motor output [Hp]	0.5	0.75	1.0	1.5	1.5	3.0	5.0	7.5	10.0	15	20	25	30	40	50	60	75	100	125	150	175	200	250	
MP 204	•	•	•	•	•	•	•	•	•	•	•	•	•	•	•	•	•	•	•	•	•	•	•	•
Pt100							•	•	•	•	•	•	•	•	•	•	•	•	•	•	•	•	•	•
Pt1000	•	•	•	•	•	•	•	•																
Zinc anode				•	•	•	•	•	•	•	•	•	•	•	•	•	•	•	•	•	•	•	•	•
Vertical flow sleeve	•	•	•	•	•	•	•	•	•	•	•	•	•	•	•	•	•	•	•	•	•	•	•	•
Horizontal flow sleeve	•	•	•	•	•	•	•	•	•	•	•	•	•	•	•	•	•	•	•	•	•	•	•	•
SA-SPM6	•	•	•	•	•	•	•																	
GO remote	•	•	•	•	•	•	•	•	•	•	•	•	•	•	•	•	•	•	•	•	•	•	•	•
RS-485 communication module	•	•	•	•	•	•	•	•	•	•	•	•	•	•	•	•	•	•	•	•	•	•	•	•

Motor protection of single-phase motors, see page [106](#).

Identification

Type key, SP pumps

Example	475	S	500	-	5	-	A	B
Rated flow rate in gpm								
Type range								
Stainless steel parts of material								
S = AISI 304 (EN 1.4301) SS								
N = AISI 316 (EN 1.4401) SS								
R = AISI 904L (EN 1.4539) SS								
Hp of motor								
Number of impellers								
First reduced-diameter impeller (A, B or C)								
Second reduced-diameter impeller (A, B or C)								

Type key, MS 402 motors

Example	MS	4	02
Motor submersible			
Minimum well casing diameter in inches			
Generation			
= AISI 304 (EN 1.4301) stainless steel			

Type key, MS 4000 motors

Example	MS	4	000	R
Motor submersible				
Minimum well casing diameter in inches				
Generation				
= AISI 304 (EN 1.4301) stainless steel				
R = AISI 904L (EN 1.4539) stainless steel				
I = AISI 304 (EN 1.4301) + Derated				
RE = AISI 904L (EN 1.4539) + FKM				
EI = AISI 304 (EN 1.4301) + Derated + FKM				

Type key, MS 6000C

Example pump: MS 6000CQFT40 3 x 460/60 25 Hp

Description	MS 6000C	Q	F	T40	3 x	25
					460/60	Hp
Motor type						
Material type						
= AISI 304 stainless steel (EN 1.4301)						
R = AISI 904L stainless steel (EN 1.4539)						
Rubber						
= NBR						
E = FKM						
Shaft seal						
= Ceramic/carbon BXPFF/NBR						
S = SiC/SiC Q1Q1VFF/FKM						
Q = SiC/SiC Q1Q1PFF/NBR						
Radial bearings						
= Ceramic/hard metal						
W = SiC/Tungsten carbide						
Motor liquid						
= SML-3						
D = Demineralized water						
H = Glycol 60 vol % HTF						
Flange extension						
= Without						
F = With						
Tempcon						
= With						
X = Without						
Maximum liquid temperature						
T40 = 104 °F (40 °C)						
T60 = 140 °F (60 °C)						
Voltage						
3 x 460/60 = 3 x 440-460-480 V, 60 Hz						
3 x 208-230/60 = 3 x 208-220-230 V, 60 Hz						
3 x 575/60 = 3 x 575 V, 60 Hz						
Method of starting						
= DOL						
SD = SD						
Motor power						
5 Hp 3.7 kW 6"						
7.5 Hp 5.5 kW 6"						
10 Hp 7.5 kW 6"						
15 Hp 11 kW 6"						
20 Hp 15 kW 6"						
25 Hp 18.5 kW 6"						
30 Hp 22 kW 6"						
40 Hp 30 kW 6"						

Type key, MMS motors

Example pump: MMS 3 x 460/60 75 Hp

Example	MMS	6	000	N	3 x 460/60	75 Hp
Motor type						
Minimum well casing diameter in inches						
Generation						
Material type						
= Cast iron EN-JL1040						
N = AISI 316 (EN 1.4401) SS						
Voltage						
3 x 460/60 = 3 x 440-460-480 V, 60 Hz						
Method of starting						
= DOL						
SD = SD						
Motor power						
40 Hp 30 kW 8"						
50 Hp 37 kW 6"						
50 Hp 37 kW 8"						
60 Hp 45 kW 6"						
60 Hp 45 kW 8"						
75 Hp 55 kW 8"						
100 Hp 75 kW 8"						
125 Hp 92 kW 8"						
150 Hp 110 kW 8"						
175 Hp 132 kW 10"						
200 Hp 147 kW 10"						
250 Hp 190 kW 10"						

2. Construction

Sectional drawing, SP pump 4" spline shaft (SP 5S - 25S)

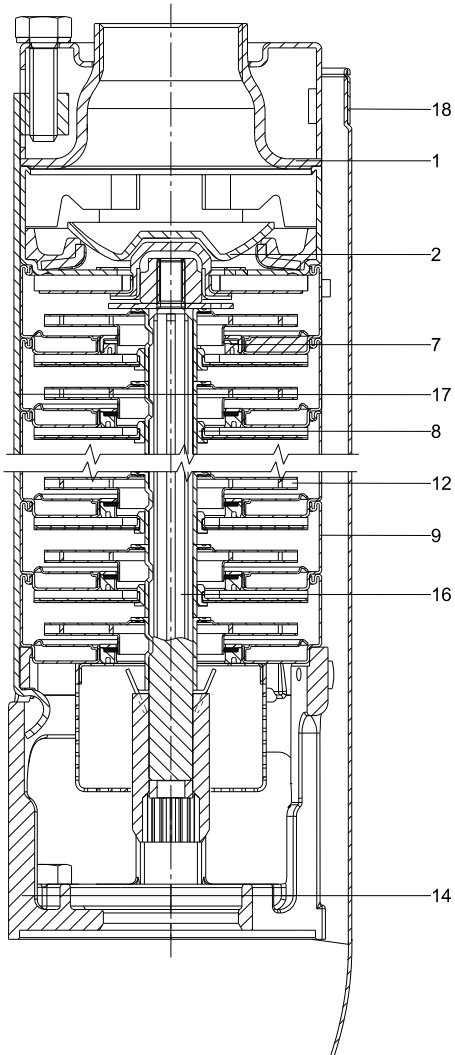

TM06 1193 1614

Fig. 12 SP pump, 4" spline shaft (SP 5S - 25S)

Material specification

Pos.	Component	Material	Standard N-version R-version		
			[AISI (EN)]		
1	Valve casing	Stainless steel	304 (1.4308)	316 (1.4408)	904L (1.4517)
2	Valve cup	Stainless steel	304 (1.4301)	316 (1.4401)	904L (1.4539)
7	Neck ring	Elastomer	NBR/TPU	NBR/TPU	NBR/TPU
8	Bearing	Elastomer	NBR	NBR	NBR
9	Chamber	Stainless steel	304 (1.4301)	316 (1.4401)	904L (1.4539)
12	Impeller	Stainless steel	304 (1.4301)	316 (1.4401)	904L (1.4539)
14	Suction interconnector	Cast stainless steel	304 (1.4308)	316 (1.4408)	904L (1.4517)
16	Shaft complete	Stainless steel	431 (1.4057)	329 (1.4460)	904L (1.4462)
17	Strap	Stainless steel	304 (1.4301)	316 (1.4401)	904L (1.4539)
18	Cable guard	Stainless steel	304 (1.4301)	316 (1.4401)	904L (1.4539)
	Washer for stop ring	Carbon/graphite	HY22 in PTFE mass	HY22 in PTFE mass	HY22 in PTFE mass
	Strainer	Stainless steel	304 (1.4301)	316 (1.4401)	904L (1.4539)
	Valve seat	Elastomer	NBR	NBR-FKM	NBR-FKM

Sectional drawing, SP pump 4" smooth shaft (SP 35S - 77S)

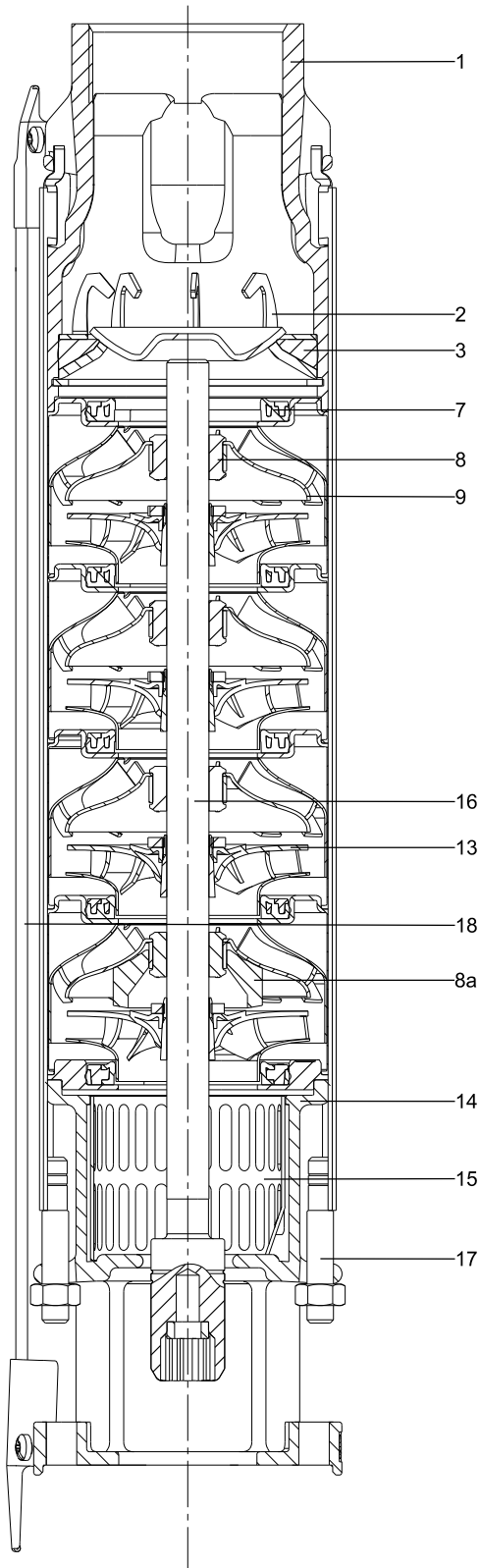

TM06 1110 1614

Material specification

Pos.	Component	Material	Standard N-version R-version		
			[AISI (EN)]		
1	Valve casing	Cast stainless steel	304 (1.4308)	316 (1.4408)	904L (1.4517)
2	Valve cup	Cast stainless steel	304 (1.4301)	316 (1.4401)	904L (1.4539)
3	Valve seat	NBR-FKM	NBR-FKM	NBR-FKM	NBR-FKM
7	Neck ring	TPU/PPS-FKM	TPU/ PPS-FKM	TPU/ PPS-FKM	TPU/ PPS-FKM
8	Bearing	LSR-FKM	LSR/FKM	LSR/FKM	LSR/FKM
8a	Washer for stop ring	Carbon/graphite	HY22 in PTFE mass	HY22 in PTFE mass	HY22 in PTFE mass
9	Chamber	Stainless steel	304 (1.4301)	316 (1.4401)	904L (1.4539)
13	Impeller	Stainless steel	304 (1.4301)	316 (1.4401)	904L (1.4539)
14	Suction interconnector	Cast stainless steel	304 (1.4308)	316 (1.4408)	904L (1.4517)
15	Strainer	Stainless steel	304 (1.4301)	316 (1.4401)	904L (1.4539)
16	Shaft complete	Stainless steel	1.4057	1.4460	1.4462
17	Strap	Stainless steel	304 (1.4301)	316 (1.4401)	904L (1.4539)
18	Cable guard	Stainless steel	304 (1.4301)	316 (1.4401)	904L (1.4539)

Fig. 13 SP pump, 4" smooth shaft (SP 35S - 77S)

Sectional drawing, SP pump 6" (SP 85S - 300S)

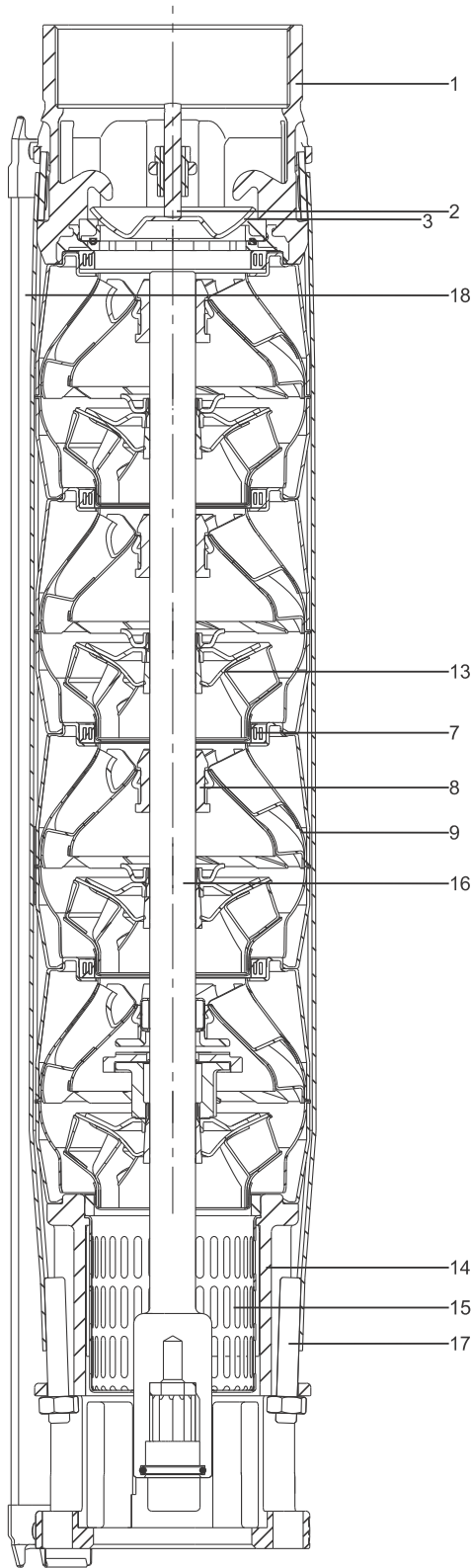

Fig. 14 Example, SP pump, 6" (SP 85S - 300S)

Material specification

Pos.	Component	Material	Standard	N-version	R-version
			[AISI (EN)]		
1	Valve casing	Stainless steel	304 (1.4308)	316 (1.4408)	904L (1.4517)
2	Valve cup	Stainless steel	304 (1.4301)	316 (1.4401)	904L (1.4539)
3	Valve seat	Elastomer	NBR-FKM	NBR-FKM	NBR-FKM
7	Neck ring	Elastomer	NBR-FKM	NBR-FKM	NBR-FKM
8	Bearing	NBR-FKM-LSR	NBR-FKM-LSR	NBR-FKM-LSR	NBR-FKM-LSR
9	Chamber	Stainless steel	304 (1.4301)	316 (1.4401)	904L (1.4539)
13	Impeller	Stainless steel	304 (1.4301)	316 (1.4401)	904L (1.4539)
14	Suction interconnector	Cast stainless steel	304 (1.4308)	316 (1.4408)	904L (1.4517)
15	Strainer	Stainless steel	304 (1.4301)	316 (1.4401)	904L (1.4539)
16	Shaft complete	Stainless steel	431 (1.4057)	329 (1.4460)	904L (1.4462)
17	Strap	Stainless steel	304 (1.4301)	316 (1.4401)	904L (1.4539)
18	Cable guard	Stainless steel	304 (1.4301)	316 (1.4401)	904L (1.4539)

TM06 9924 3717

Sectional drawing, SP pump 8" (SP 385S - 475S)

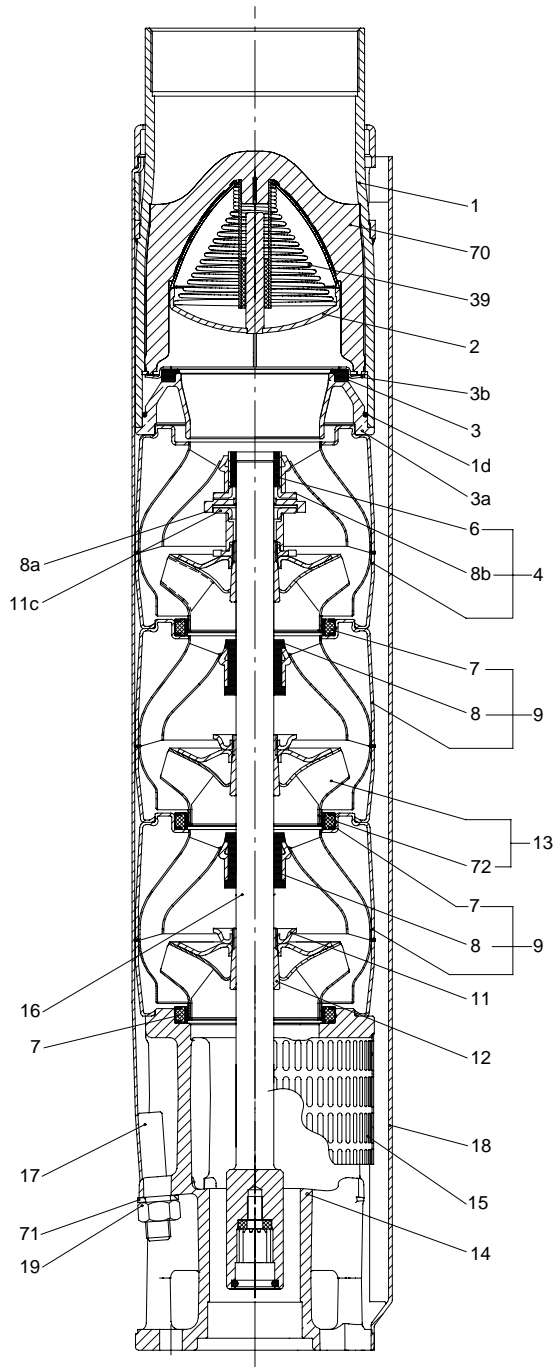

TM01 2359 2301

Fig. 15 SP pump, 8" (SP 385S - 475S)

Material specification

Pos.	Component	Materials	Standard	N	R
			[AISI (EN)]		
1	Valve casing	Stainless steel	304 (1.4301)	316 (1.4401)	904L (1.4539)
1d	O-ring	Elastomer	NBR	NBR	NBR
2	Valve cup	Stainless steel	304 (1.4301)	316 (1.4401)	904L (1.4539)
3	Valve seat	Elastomer	NBR	NBR	FKM
3a	Lower valve seat retainer	Stainless steel	316 (1.4401)	316 (1.4401)	904L (1.4517)
3b	Upper valve seat retainer	Stainless steel	304 (1.4301)	316 (1.4401)	904L (1.4539)
4	Top chamber	Stainless steel	304 (1.4301)	316 (1.4401)	904L (1.4539)
6	Upper bearing	Stainless steel/NBR	304 (1.4301)	316 (1.4401)	904L (1.4539)
7	Neck ring	Elastomer (optional FKM)	NBR/PPS	NBR/PPS	NBR/PPS
8	Bearing	Elastomer (optional FKM)	NBR	NBR	NBR
8a	Washer for stop ring	Carbon	graphite HY22 in PTFE mass	graphite HY22 in PTFE mass	graphite HY22 in PTFE mass
8b	Stop ring	Stainless steel	316 (1.4401)	316 (1.4401)	904L (1.4539)
9	Chamber	Stainless steel	304 (1.4301)	316 (1.4401)	904L (1.4539)
11	Split cone nut	Stainless steel	304 (1.4301)	316 (1.4401)	904L (1.4539)
11c	Nut for stop ring	Stainless steel	316 (1.4401)	316 (1.4401)	904L (1.4539)
12	Split cone	Stainless steel	304 (1.4301)	316 (1.4401)	904L (1.4539)
13	Impeller	Stainless steel	304 (1.4301)	316 (1.4401)	904L (1.4539)
14	Suction interconnector	Stainless steel	304 (1.4308)	316 (1.4408)	904L (1.4517)
15	Strainer	Stainless steel	304 (1.4301)	316 (1.4401)	904L (1.4539)
16	Shaft complete	Stainless steel	431 (1.4057)	329 (1.4460)	329 (1.4460)
17	Strap	Stainless steel	304 (1.4301)	316 (1.4401)	904L (1.4539)
18	Cable guard	Stainless steel	304 (1.4301)	316 (1.4401)	904L (1.4539)
19	Nut for strap	Stainless steel	304 (1.4301)	316 (1.4401)	904L (1.4539)
39	Spring for valve cup	Stainless steel	304 (1.4301)	316 (1.4401)	SAF 2205
70	Valve guide	Stainless steel	304 (1.4301)	316 (1.4401)	904L (1.4539)
71	Washer	Stainless steel	316 (1.4401)	316 (1.4401)	904L (1.4539)
72	Wear ring	Stainless steel	304 (1.4301)	316 (1.4401)	904L (1.4539)

Sectional drawing, SP pump 10" (SP 625S - 1100S)

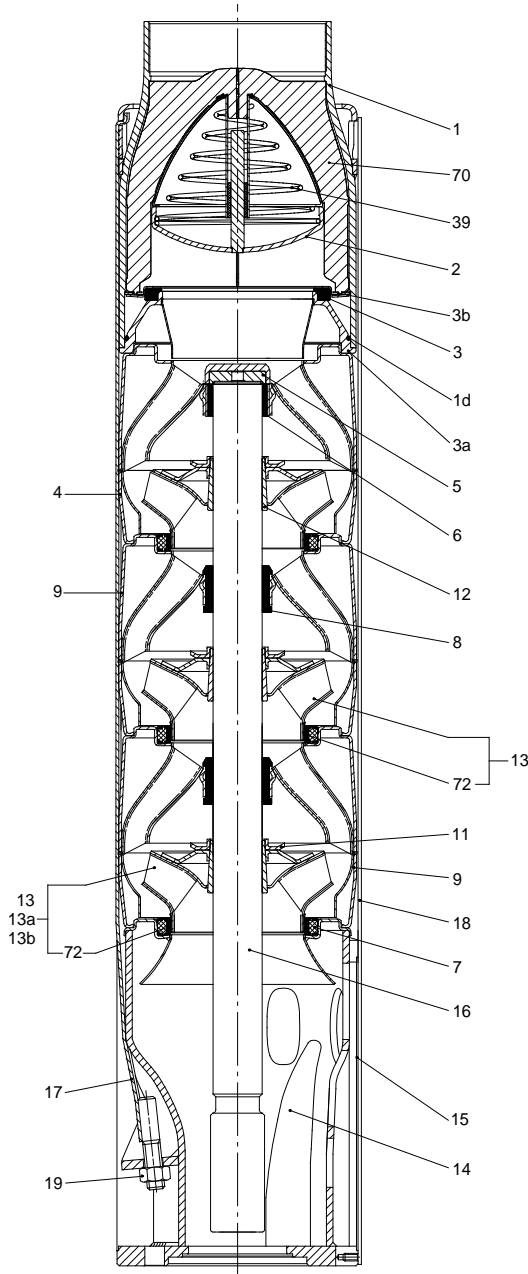

Fig. 16 SP pump, 10" (SP 625S - 1100S)

TM01 2363 2701

Material specification

Pos.	Description	Material	Standard	N
			[AISI (EN)]	
Valve casing				
1	Valve casing	Stainless steel	304 (1.4301)	316 (1.4401)
1d	O-ring	Elastomer	NBR	NBR
2	Valve cup	Stainless steel	304 (1.4301)	316 (1.4401)
3	Valve seat	Stainless steel	304 (1.4301)	316 (1.4401)
3a	Lower valve seat retainer	Stainless steel	304 (1.4301)	316 (1.4401)
3b	Upper valve seat retainer	Stainless steel	304 (1.4301)	316 (1.4401)
39	Spring for valve cup	Stainless steel	301 (1.4310)	316 (1.4401)
70	Valve guide	Stainless steel	304 (1.4301)	316 (1.4401)
78	Nameplate	Stainless steel	304 (1.4301)	316 (1.4401)
79	Rivet	Stainless steel	304 (1.4301)	316 (1.4401)
63	Connecting piece	Stainless steel	304 (1.4301)	316 (1.4401)
Chamber stack				
4	Top chamber	Stainless steel	304 (1.4301)	316 (1.4401)
5	Uphrust disc	Carbon/graphite HY22 in PTFE mass		
6	Top bearing	Stainless steel/ NBR	304 (1.4301)	316 (1.4401)
7	Neck ring	Elastomer	NBR/PPS	NBR/PPS
8	Bearing	Elastomer	NBR	NBR
9	Chamber	Stainless steel	304 (1.4301)	316 (1.4401)
11	Nut for split cone	Stainless steel	304 (1.4301)	316 (1.4401)
12	Split cone	Stainless steel	304 (1.4301)	316 (1.4401)
13	Impeller	Stainless steel	304 (1.4301)	316 (1.4401)
16	Shaft with coupling	Stainless steel	431 (1.4057)	329 (1.4460)
18	Cable guard	Stainless steel	304 (1.4301)	316 (1.4401)
18a, 18b	Screw for cable guard	Stainless steel	304 (1.4301)	316 (1.4401)
23	Rubber guard	Elastomer	NBR	NBR
72	Wear ring	Stainless steel	304 (1.4301)	316 (1.4401)
Suction interconnector				
14	Suction interconnector	Stainless steel	304 (1.4308)	316 (1.4408)
15	Strainer	Stainless steel	304 (1.4301)	316 (1.4401)
17	Strap	Stainless steel	304 (1.4301)	316 (1.4401)
19	Nut for strap	Stainless steel	304 (1.4301)	316 (1.4401)
19a	Nut	Stainless steel	316 (1.4401)	316 (1.4401)
22	Bolts	Stainless steel	316 (1.4401)	316 (1.4401)
28, 28a	Lock for strainer	Stainless steel	329 (1.4460)	329 (1.4460)

Sectional drawing, MS motors

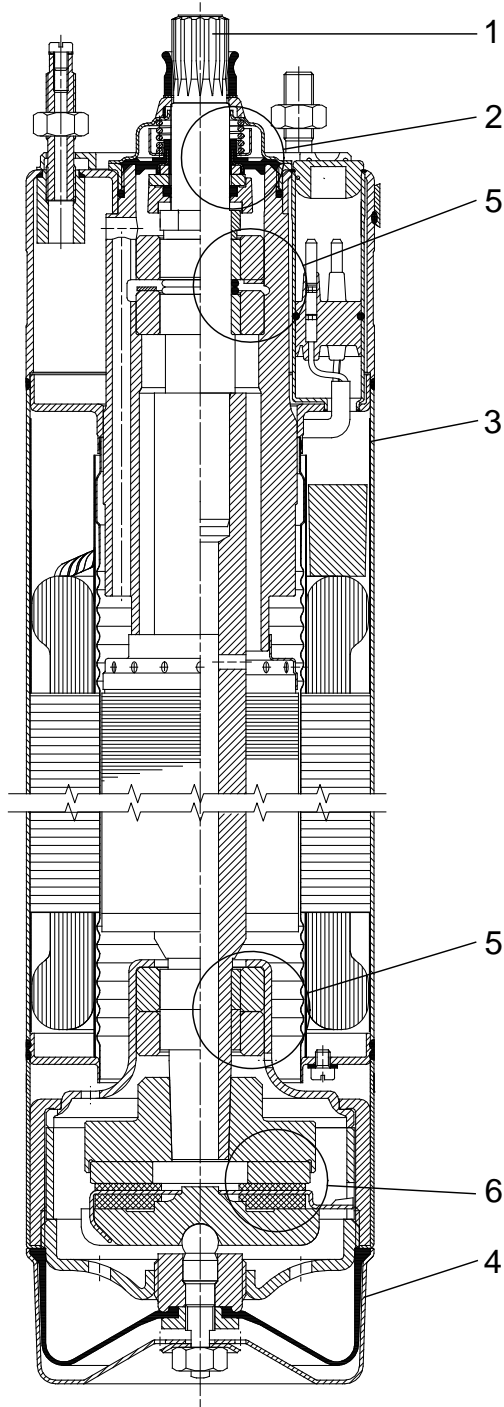

Fig. 17 MS 4000 motor

TM00 7865 2196

Material specification, MS 402, MS 4000, and MS 6000C motors

Pos.	Part	MS 402	MS 4000 MS 6000C
		[AISI (EN)]	
1	Shaft	431	431
2	Shaft seal	NBR	NBR/SiC/SiC
3	Motor sleeve	304 (1.4301)	304 (1.4301)
4	Motor end shield	304 (1.4301)	304 (1.4301)
5	Radial bearing	Ceramic	Ceramic/ tungsten carbide
6	Axial bearing	Ceramic/carbon	Ceramic/carbon
	Rubber parts	NBR	NBR

R-version motor

Pos.	Part	MS 4000 MS 6000C
1	Shaft	318 LN
2	Shaft seal	SiC/SiC
3	Motor sleeve	904L (1.4539)
4	Motor end shield	904L (1.4539)
5	Radial bearing	Ceramic/tungsten carbide
6	Thrust bearing	Ceramic/carbon
	Rubber parts	NBR

Sectional drawing, MMS motors

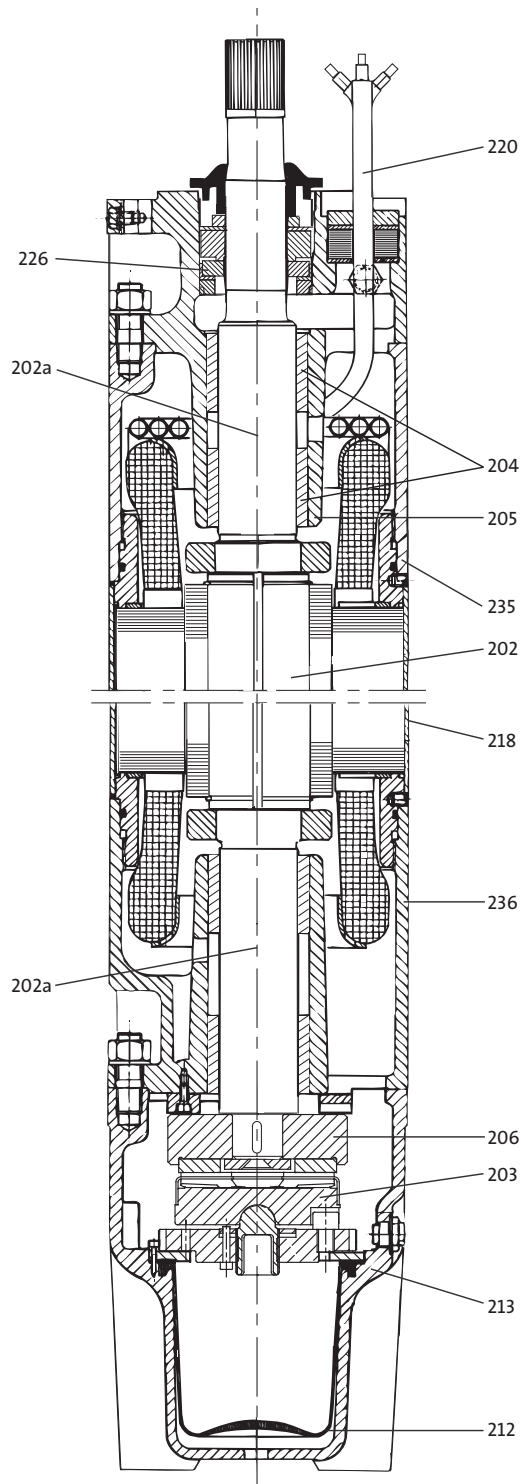

Fig. 18 MMS 10000 motor

TM01 4985 0404

Material specification

MMS motors, submersible rewindable versions

Pos.	Component	Material	[AISI (EN)]
202	Shaft	Steel	(1.0533)
202a	Shaft ends	Stainless steel	316/329 (1.4401/1.4460)
203/ 206	Thrust bearing Stationary/ rotating part	6", 0.5 - 20 Hp 6", 25-50 Hp 8" - 10"	Hardened steel/EPDM Ceramic/ carbon
204	Bearing bush	6" - 10"	Carbon
205	Bearing housing, upper	Cast iron	A126 Class B
212	Diaphragm	CR	
213	Motor end shield	Cast iron	A126 Class B
218	Motor sleeve	Stainless steel	304 (1.4301)
220	Motor cable	EPR	
226	Shaft seal	SiC/SiC	
235	Intermediate housing	Cast iron	A126 Class B
236	Bearing housing, lower	Cast iron	A126 Class B

MMS motors, N and R versions

Pos.	Component	Material	Version	
			N	R
			[AISI (EN)]	
202	Shaft	Steel	(1.0533)	
202a	Shaft ends	Stainless steel	316/329 (1.4401/1.4460)	318LN (1.4462)
203/ 206	Thrust bearing Stationary/ rotating part	6", 0.5 - 20 Hp 6", 25-50 Hp 8" - 10"	Hardened steel/EPDM Ceramic/ carbon	
204	Bearing bush	6" - 10"	Carbon	
205	Bearing housing, upper	Stainless steel	316 (1.4401)	904L (1.4539)
212	Diaphragm	CR		
213	Motor end shield	Stainless steel	316 (1.4401)	904L (1.4539)
218	Motor sleeve	Stainless steel	316 (1.4401)	904L (1.4539)
220	Motor cable	EPR		
226	Shaft seal	SiC/SiC		
235	Intermediate housing	Stainless steel	316 (1.4401)	904L (1.4539)
236	Bearing housing, lower	Stainless steel	316 (1.4401)	904L (1.4539)

3. Operating conditions

Operating conditions

Flow rate, Q: 0.44 - 1475 gpm (0.1 - 335 m³/h).

Head, H: Maximum 2657 ft (810 m).

Maximum liquid temperature

Motor cooling requirements*: Maximum liquid temperature / minimum velocity / flow past the motor					
Motor type	Min. well casing or sleeve diameter	Minimum velocity	Minimum flow	Maximum temperature of pumped liquid	
				Vertical installation	Horizontal installation
	in. (mm)	fps (m/s)	gpm (m ³ /h)	° F (° C)	° F (° C)
MS402, MS4000	4 (102)	If at 0.0	If at 0.0	86 (30)	Flow sleeve recommended
MS402, MS4000	4 (102)	0.25 (0.08)	1.2 (0.27)	104 (40)	104 (40)
MS6000C (T40) (Standard)	6 (152)	0.50 (0.15)	9 (2)	104 (40)	104 (40)
MS6000C (T60) (High temperature)	6 (152)	3.3 (1.0)	30 (6.8)	140 (60)	140 (60)
MMS6	6 (152)	0.15 (0.05)	13 (3)	86 (30)	86 (30)
MMS8000	8 (203)	0.50 (0.15)	25 (5.7)	86 (30)	86 (30)
MMS10000 (175, 200 HP)	10 (254)	0.50 (0.15)	55 (12.5)	86 (30)	86 (30)
MMS10000 (250 HP)	10 (254)	0.50 (0.15)	41 (9.3)	86 (30)	86 (30)

Note: For MMS 6, 50 Hp; MMS 8000, 150 Hp; the maximum liquid temperature is 9 °F (5 °C) lower than the values stated in the table.
For MMS 10000, 250 Hp, the temperature is 18 °F (10 °C) lower.

Operating pressure

Motor	Maximum operating pressure
MS 402, 4"	217 psi (1.5 Mpa) (15 bar)
MS4000, 4" MS6000C, 6"	870 psi (6 Mpa) (60 bar)
MMS 6" to 10" rewindable	

4. Selection

5S - 25S easy selection charts

5 gpm easy selection chart

Flow range 1.2 to 7 gpm

Pump outlet 1" NPT

Ratings in gallons per minute (gpm)

Pump model	Hp	psi	Depth to pumping water level (lift) in ft																										
			20	40	60	80	100	120	140	160	180	200	220	240	260	280	300	340	400	460	520	600	700	800	900	1000	1100		
5S03-9	0.33	0				7.1	6.7	6.2	5.8	5.3	4.8	4.3	3.2	2.1															
		20		7.0	6.6	6.1	5.7	5.2	4.6	4.0	2.8	1.6																	
		30		6.5	6.0	5.6	5.1	4.6	3.8	2.9	1.5																		
		40	6.7	6.0	5.5	5.1	4.4	3.8	2.4																				
		50	6.2	5.5	4.9	4.4	3.4	2.5	1.3																				
		60	4.6	4.9	4.2	3.5	1.9																						
Shut-off psi			102	94	85	76	68	59	50	42	33	24	16	7															
5S05-13	0.5	0					7.1	6.8	6.4	6.1	5.8	5.5	5.2	4.8	4.5	3.9	2.3												
		20		7.3	7.0	6.7	6.3	6.0	5.7	5.4	5.1	4.7	4.3	3.7	3.1	2.0													
		30		7.2	6.9	6.6	6.3	6.0	5.7	5.4	5.0	4.7	4.2	3.7	2.8	2.0													
		40	7.2	6.9	6.6	6.3	5.9	5.6	5.3	5.0	4.6	4.2	3.5	2.8	1.6														
		50	6.8	6.5	6.2	5.9	5.6	5.3	4.9	4.6	4.0	3.5	2.6	1.6															
		60	6.5	6.2	5.8	5.5	5.2	4.9	4.5	4.0	3.3	2.6	1.3																
Shut-off psi			152	143	134	126	117	108	100	91	82	74	65	56	48	39	30	13											
5S07-18	0.75	0						7.1	6.9	6.7	6.4	6.2	6.0	5.8	5.6	5.1	4.2	2.7											
		20					7.1	6.8	6.6	6.4	6.2	5.9	5.7	5.5	5.3	5.0	4.5	3.2											
		30					7.0	6.8	6.6	6.3	6.1	5.9	5.7	5.5	5.2	5.0	4.7	4.0	2.5										
		40			7.2	7.0	6.8	6.5	6.3	6.1	5.9	5.6	5.4	5.2	4.9	4.7	4.4	3.5	1.5										
		50		7.2	7.0	6.7	6.5	6.3	6.1	5.8	5.6	5.4	5.1	4.9	4.6	4.3	3.9	2.9											
		60	7.1	6.9	6.7	6.5	6.2	6.0	5.8	5.6	5.3	5.1	4.9	4.6	4.3	3.9	3.4	2.1											
Shut-off psi			213	204	195	187	178	169	161	152	143	135	126	117	109	100	91	74	48	22									
5S10-22	1.0	0							7.1	6.9	6.7	6.6	6.4	6.2	5.8	5.3	4.7	3.8	1.7										
		20						7.1	6.9	6.7	6.5	6.3	6.1	6.0	5.8	5.4	4.8	4.0	2.8										
		30						7.0	6.8	6.7	6.5	6.3	6.1	5.9	5.7	5.6	5.2	4.6	3.6	2.1									
		40						7.0	6.8	6.6	6.5	6.3	6.1	5.9	5.7	5.5	5.4	5.0	4.3	3.1	1.3								
		50			7.2	7.0	6.8	6.6	6.4	6.2	6.1	5.9	5.7	5.5	5.3	5.1	4.7	3.9	2.5										
		60		7.1	6.9	6.8	6.6	6.4	6.2	6.0	6.0	5.7	5.5	5.3	5.1	4.9	4.4	3.5	1.7										
Shut-off psi				245	237	228	219	211	202	194	185	176	168	159	150	142	124	98	72	46	12								
5S15-26	1.5	0								7.1	6.9	6.7	6.6	6.4	6.2	5.9	5.4	4.9	4.1	2.1									
		20							7.1	6.9	6.8	6.6	6.5	6.3	6.0	5.5	5.1	4.5	3.4										
		30							7.1	6.9	6.7	6.6	6.4	6.3	6.1	5.8	5.4	4.8	4.2	2.9									
		40							7.0	6.9	6.7	6.6	6.4	6.3	6.1	6.0	5.6	5.2	4.6	5.6	2.4								
		50							7.0	6.9	6.7	6.5	6.4	6.2	6.1	5.9	5.8	5.5	5.0	4.4	3.6	1.7							
		60							7.0	6.8	6.7	6.5	6.4	6.2	6.1	5.9	5.8	5.6	5.3	4.8	4.1	3.1							
Shut-off psi							269	260	252	243	234	226	217	208	200	191	174	148	122	96	61	18							
5S15-31	1.5	0									7.1	6.9	6.8	6.7	6.4	6.0	5.6	5.2	4.6	3.5	1.6								
		20									7.1	6.9	6.8	6.6	6.5	6.2	5.9	5.5	5.1	4.4	3.2	0.9							
		30									7.0	6.9	6.8	6.6	6.5	6.2	5.9	5.5	5.1	4.4	3.2	0.9							
		40									7.0	6.9	6.8	6.6	6.5	6.4	6.1	5.7	5.3	4.9	4.2	2.8							
		50									7.1	7.0	6.9	6.7	6.6	6.5	6.3	6.2	6.0	5.6	5.2	4.7	4.0	2.3					
		60									7.1	7.0	6.8	6.7	6.6	6.5	6.3	6.2	6.1	5.8	5.4	5.0	4.5	3.7	1.7				
Shut-off psi									320	311	303	294	285	277	268	259	251	233	207	181	155	121	77	34					

See 5S performance curves for higher head models.

Specifications are subject to change without notice.

These values are approximate. For more precise values, see the performance curves in section 6. [Curve charts and technical data](#).

7 gpm easy selection chart

Flow range 3 to 10 gpm

Pump outlet 1" NPT

Ratings in gallons per minute (gpm)

Pump model	Hp	psi	Depth to pumping water level (lift) in ft																											
			20	40	60	80	100	120	140	160	180	200	220	240	260	280	300	340	400	460	520	600	700	800	900	1000	1100			
7S03-8	0.33	20	10.0	9.5	8.7	8.0	7.2	6.4	5.0	3.7	1.8																			
		30	9.3	8.7	7.9	7.1	6.1	5.1	2.6																					
		40	8.5	7.8	7.0	6.1	4.5	2.9	1.5																					
		50	7.6	6.9	5.8	4.7	2.3																							
		60	6.7	5.8	3.9	2.0																								
Shut-off psi			86	77	69	60	52	43	34	26	17	8																		
7S05-11	0.5	0					9.9	9.5	8.9	8.4	7.8	7.3	6.7	6.0	5.0	4.0														
		20				9.8	9.3	8.8	8.2	7.7	7.1	6.5	5.8	4.7	3.5	1.8														
		30	10.1	9.7	9.2	8.7	8.1	7.6	7.0	6.4	5.6	4.7	2.9																	
		40	9.6	9.2	8.6	8.1	7.5	6.9	6.2	5.6	4.3	3.0	1.5																	
		50	9.1	8.5	8.0	7.4	6.8	6.2	5.3	4.3	2.2																			
Shut-off psi			122	113	105	96	87	79	70	61	53	44	35	27	18	10														
7S07-15	0.75	0					10.2	9.9	9.5	9.2	8.8	8.4	8.0	7.6	7.1	6.7	5.6	2.9												
		20				10.1	9.8	9.4	9.0	8.6	8.2	7.8	7.4	7.0	6.5	6.1	5.4	3.6												
		30			10.0	9.7	9.4	9.0	8.6	8.2	7.8	7.4	6.9	6.5	5.9	5.4	4.5	1.8												
		40	10.0	9.7	9.3	8.9	8.5	8.1	7.7	7.3	6.9	6.4	5.9	5.2	4.5	3.2	1.0													
		50	9.9	9.6	9.2	8.9	8.5	8.1	7.6	7.2	6.8	6.4	5.8	5.2	4.2	3.2	1.6													
Shut-off psi			170	101	153	144	135	127	118	110	101	92	84	75	66	58	49	32	6											
7S10-19	1.0	0						10.1	9.8	9.6	9.3	9.0	8.7	8.4	8.0	7.4	6.4	4.8												
		20				10.0	9.8	9.5	9.2	8.9	8.6	8.3	7.9	7.6	7.3	6.6	5.3	2.8												
		30				10.0	9.7	9.5	9.2	8.9	8.5	8.2	7.9	7.6	7.3	6.9	6.2	4.6	1.4											
		40			10.0	9.7	9.4	9.1	8.8	8.5	8.2	7.8	7.5	7.2	6.9	6.5	5.6	3.7												
		50	10.2	9.9	9.7	9.4	9.1	8.8	8.4	8.1	7.8	7.5	7.2	6.8	6.5	6.0	5.0	2.4												
Shut-off psi			218	209	200	192	183	174	166	157	148	140	131	123	114	105	97	79	53	27										
7S15-26	1.5	0							10.1	9.9	9.7	9.5	9.3	8.8	8.1	7.4	6.7	5.5												
		20						10.0	9.8	9.6	9.4	9.2	9.0	8.8	8.3	7.6	6.9	6.1	4.4											
		30						10.0	9.8	9.6	9.4	9.2	9.0	8.7	8.5	8.0	7.3	6.6	5.7	3.7										
		40				10.1	10.0	9.8	9.6	9.4	9.1	8.9	8.7	8.5	8.2	7.8	7.1	6.3	5.2	2.9										
		50	10.1	9.9	9.7	9.6	9.3	9.1	8.9	8.7	8.4	8.2	8.0	7.5	6.8	5.9	4.7	1.9												
Shut-off psi					274	265	257	248	239	231	222	213	205	196	187	179	161	135	110	84	49									
7S20-32	2.0	0							10.6	10.5	10.4	10.4	10.3	10.1	9.6	9.1	8.4	7.3	5.7											
		20						10.5	10.5	10.4	10.3	10.3	10.2	10.0	9.8	9.2	8.6	7.8	6.6	4.8										
		30						10.5	10.5	10.4	10.3	10.2	10.1	10.0	9.9	9.6	9.0	8.3	7.5	6.2	4.3									
		40				10.5	10.5	10.4	10.3	10.2	10.1	10.0	9.9	9.7	9.4	8.8	8.0	7.2	5.8	3.9										
		50	10.5	10.4	10.3	10.2	10.1	10.0	9.8	9.7	9.5	9.1	8.5	7.7	6.8	5.4	3.3													
Shut-off psi					343	334	326	317	308	300	291	282	274	265	256	239	213	187	161	126	83									

See 7S performance curves for higher head models. Specifications are subject to change without notice. These values are approximate. For more precise values, see the performance curves in section 6. [Curve charts and technical data.](#)

10 gpm easy selection chart

Flow range 5 to 14 gpm

Pump outlet 1.25" NPT

Ratings in gallons per minute (gpm)

Pump model	Hp	psi	Depth to pumping water level (lift) in ft																											
			20	40	60	80	100	120	140	160	180	200	220	240	260	280	300	340	400	460	520	600	700	800	900	1000	1100			
10S03-6	0.33	20	14.0	13.2	12.4	10.6	8.9	5.3																						
		30	13.2	11.8	10.4	8.4																								
		40	11.9	10.1	8.3																									
		50	9.8	7.5																										
		60	7.7	3.9																										
Shut-off psi			64	55	47	38	29	21	12	3																				
10S05-9	0.5	0				14.1	13.4	12.4	11.4	10.4	9.5	8.3	6.6	3.5																
		20		13.9	13.1	12.1	11.1	10.1	9.2	7.9	5.8	2.0																		
		30	13.8	13.0	12.0	11.0	10.0	9.0	7.6	5.3	1.2																			
		40	12.8	11.8	10.8	9.8	8.8	7.3	4.8																					
		50	11.7	10.7	9.7	8.6	7.0	4.3																						
Shut-off psi			100	92	83	74	66	57	48	40	31	23	14	5																
10S07-12	.75	0				14.3	13.8	13.2	12.5	11.7	11.0	10.2	9.5	8.7	7.6	6.0														
		20		14.2	13.6	12.9	12.2	11.5	10.7	10.0	9.3	8.4	7.2	5.4	2.6															
		30		14.1	13.5	12.9	12.1	11.4	10.6	9.9	9.2	8.2	7.0	5.0	2.0															
		40	14.0	13.4	12.8	12.0	11.3	10.5	9.8	9.0	8.1	6.7	4.7	1.4																
		50	13.3	12.6	11.9	11.1	10.4	9.7	8.9	7.9	6.5	4.2																		
Shut-off psi			137	129	120	111	103	94	85	77	68	59	51	42	33	25	16													
10S10-15	1.0	0				14.1	13.6	13.1	12.5	11.9	11.3	10.7	10.1	9.6	8.2	3.8														
		20		13.9	13.5	12.9	12.3	11.7	11.1	10.5	10.0	9.4	8.7	7.9	5.2															
		30			13.9	13.4	12.8	12.2	11.6	11.0	10.5	9.9	9.3	8.6	7.7	6.6	2.6													
		40	14.2	13.8	13.3	12.7	12.1	11.5	10.9	10.4	9.8	9.2	8.5	7.6	6.3	4.6														
		50	14.1	13.7	13.2	12.6	12.1	11.4	10.9	10.3	9.7	9.1	8.3	7.4	6.1	4.3	1.7													
Shut-off psi			174	165	157	148	139	131	122	113	105	96	87	79	70	61	53	35	10											
10S15-21	1.5	0					14.2	13.9	13.6	13.3	12.9	12.5	12.0	11.2	9.9	8.5	6.3													
		20					14.1	13.9	13.5	13.1	12.7	12.3	11.9	11.5	11.0	10.2	8.9	6.9	2.9											
		30					14.1	13.8	13.5	13.1	12.7	12.3	11.8	11.4	11.0	10.5	9.7	8.3	5.7											
		40					14.1	13.8	13.4	13.0	12.6	12.2	11.8	11.3	10.9	10.5	10.1	9.2	7.5	4.1										
		50					14.0	13.7	13.3	13.0	12.5	12.1	11.7	11.3	10.8	10.4	10.0	9.6	8.7	6.5	2.0									
Shut-off psi			237	229	220	211	203	194	185	177	168	159	151	142	133	125	107	81	55	29										
10S30-27	2.0	0								14.1	13.9	13.7	13.4	12.8	11.8	10.8	9.8	8.3	4.7											
		20								14.1	13.8	13.6	13.3	13.0	12.7	12.0	11.0	10.0	9.0	7.1	1.5									
		30									14.0	13.8	13.5	13.3	12.9	12.6	12.3	11.6	10.6	9.7	8.6	6.2								
		40									14.2	14.0	13.8	13.5	13.2	12.9	12.6	12.2	11.9	11.2	10.3	9.3	8.1	5.2						
		50									14.2	14.0	13.7	13.5	13.2	12.8	12.5	12.2	11.9	11.5	10.9	9.9	8.9	7.4	3.8					
Shut-off psi										285	276	268	259	250	242	233	224	216	207	198	181	155	129	103	68	25				
10S30-34	3.0	0														13.8	13.2	12.5	11.9	10.9	9.6	7.9	4.8							
		20														13.9	13.7	13.3	12.7	12.0	11.3	10.3	8.9	6.7	2.7					
		30														13.9	13.7	13.5	13.1	12.4	11.7	11.0	10.0	8.5	6.0	1.3				
		40														14.0	13.8	13.7	13.5	13.3	12.8	12.2	11.5	10.8	9.7	8.0	5.1			
		50														14.0	13.8	13.6	13.4	13.2	13.0	12.6	11.9	11.2	10.5	9.4	7.5	4.2		
Shut-off psi															332	324	315	306	298	289	272	246	220	194	159	116	73	29		

See 10S performance curves for higher head models.

Specifications are subject to change without notice.

These values are approximate. For more precise values, see the performance curves in section 6. [Curve charts and technical data.](#)

16 gpm easy selection chart

Flow range 10 to 20 gpm

Pump outlet 1.25" NPT

Ratings in gallons per minute (gpm)

Pump model	Hp	psi	Depth to pumping water level (lift) in ft																											
			20	40	60	80	100	120	140	160	180	200	220	240	260	280	300	340	400	460	520	600	700	800	900	1000	1100			
16205-5	.5	20	20.3	18.2	14.1	10.0	5.0																							
		30	17.3	14.4	8.0	1.6																								
		40	12.7	8.0	4.0																									
		50	6.5																											
		60	2.9																											
Shut-off psi			58	49	40	32	23	14																						
16S07-8	.75	0				20.5	19.2	17.5	15.8	12.8	9.8	5.2																		
		20			20.1	18.8	16.9	15.2	11.8	8.5	4.3																			
		30	21.2	19.9	18.4	16.9	14.3	11.8	7.5	3.2	1.6																			
		40	19.7	18.3	16.3	14.3	10.8	7.2	3.6																					
		50	17.9	16.3	13.5	10.7	6.2	1.7																						
Shut-off psi			97	88	80	71	62	54	45	36	28	19	10																	
16S10-10	1.0	0				20.8	19.8	18.8	17.3	15.9	13.7	11.4	8.0	4.7																
		20			20.5	19.4	18.3	16.8	15.3	12.9	10.5	7.0	3.5	1.8																
		30			20.3	19.3	18.1	16.8	14.8	12.8	9.8	6.7	3.3																	
		40			20.2	19.1	18.0	16.4	14.8	12.2	9.6	5.9	2.3																	
		50	20.0	19.0	17.7	16.3	14.2	12.0	8.8	5.6	2.8																			
Shut-off psi			123	115	106	97	89	80	71	63	54	45	37	28	19	11														
16S15-14	1.5	0						21.0	20.3	19.6	18.8	18.0	16.9	15.8	14.3	10.7	3.3													
		20					20.1	19.3	18.5	17.7	16.6	15.4	13.8	12.2	10.0	5.1														
		30					20.7	20.0	19.2	18.4	17.4	16.5	15.1	13.7	11.8	9.8	7.3	2.4												
		40					20.6	19.8	19.1	18.3	17.4	16.0	15.0	13.3	11.6	9.3	7.0	4.3												
		50					20.4	19.8	18.9	18.2	17.2	16.1	14.7	13.2	11.2	9.1	6.5	3.9	2.0											
Shut-off psi			167	158	149	141	132	123	115	106	97	89	80	71	63	54	37	28												
16S20-18	2.0	0							21.2	20.6	20.0	19.5	18.9	18.2	16.7	13.5	8.8	2.7												
		20							20.4	19.8	19.3	18.7	18.0	17.3	16.4	14.3	10.0	4.2												
		30							20.3	19.8	19.2	18.6	17.9	17.2	16.3	15.3	12.8	7.9	1.9											
		40							20.3	19.7	19.1	18.5	17.8	17.1	16.1	15.2	13.9	11.1	5.7											
		50							20.2	19.6	19.0	18.3	17.7	16.8	16.0	14.9	13.8	12.3	9.2	3.2										
Shut-off psi								194	186	177	168	160	151	142	134	125	116	108	90	65	39	13								
16S30-24	3.0	0													19.6	18.3	16.5	14.2	9.8	2.1										
		20													20.3	19.9	19.5	18.6	17.0	14.8	11.8	6.5								
		30													20.3	19.8	19.4	19.0	18.0	16.3	13.7	10.4	4.7							
		40													20.2	19.8	19.3	18.9	18.4	17.3	15.3	12.5	8.9	2.8						
		50													20.2	19.8	19.3	18.8	18.3	17.8	16.7	14.3	11.3	7.3						
Shut-off psi														239	230	221	213	204	195	187	169	143	117	91	57	13				
16S50-38	5.0	0																		21.5	20.4	18.7	16.5	13.4	8.9	2.1				
		20																		20.9	19.6	17.7	15.2	11.5	6.1					
		30																		21.4	20.5	19.2	17.2	14.5	10.5	4.5				
		40																		21.1	20.2	18.8	16.7	13.7	9.3	2.7				
		50																		21.6	20.7	19.8	18.4	16.1	12.8	8.0	0.8			
Shut-off psi																			314	288	262	227	184	141	98	54	11			

See 16S performance curves for higher head models.

Specifications are subject to change without notice.

These values are approximate. For more precise values, see the performance curves in section 6. [Curve charts and technical data.](#)

25 gpm easy selection chart

Flow range 18 to 32 gpm

Pump outlet 1.5" NPT

Ratings in gallons per minute (gpm)

Pump model	Hp	psi	Depth to pumping water level (lift) in ft																											
			20	40	60	80	100	120	140	160	180	200	220	240	260	280	300	340	400	460	520	600	700	800	900	1000	1100			
25S05-3	.5	20	18.6	6.5	3.3																									
		30	10.5																											
		40																												
		50																												
		60																												
Shut-off psi			31	22	13	5																								
25S07-5	.75	0			34.5	29.8	23.9	18.1																						
		20	32.9	28.6	21.8	15.1	7.5																							
		30	27.1	22.5	12.3	2.0																								
		40	19.5	11.8	5.8																									
		50	10.1																											
Shut-off psi			57	48	39	31	22	13																						
25S10-7	1.0	0				31.3	28.5	24.3	20.2	12.7	5.1																			
		20	33.2	30.3	27.6	22.9	18.3	10.4	2.5	1.3																				
		30	33.0	29.9	26.5	23.1	13.0	9.6	4.8																					
		40	29.4	26.6	21.3	16.2	8.2																							
		50	25.3	21.5	14.3	7.0	3.5																							
Shut-off psi			83	74	65	57	48	39	31	22	13	5																		
25S15-9	1.5	0				32.2	30.0	27.9	24.8	21.6	16.3	10.8																		
		20			31.5	29.3	27.2	23.7	20.3	14.5	8.8	4.4																		
		30			31.3	29.1	26.4	23.7	18.9	14.2	7.8	1.5																		
		40			30.8	28.6	26.3	22.6	18.8	12.8	6.8	3.4																		
		50	30.6	28.4	25.5	22.5	17.4	12.3	6.2																					
Shut-off psi			109	100	91	83	74	65	57	48	39	31	22	13																
25S20-11	2.0	0				33.1	31.1	29.3	27.6	25.1	22.5	18.5	14.5	9.3																
		20			32.5	30.6	28.8	27.0	24.3	21.5	17.3	13.0	7.8	2.5																
		30			32.0	30.3	28.7	26.4	24.2	20.6	16.9	12.0	7.0	3.5																
		40			31.8	30.1	28.2	26.3	23.3	20.4	15.9	11.4	6.3																	
		50	31.5	29.8	28.1	25.7	23.3	19.4	15.6	10.4	5.3	2.7																		
Shut-off psi			135	126	118	109	100	92	83	74	66	57	48	40	31	23														
25S30-15	3.0	0							32.3	31.0	29.8	28.4	27.1	25.2	20.7															
		20							31.8	30.6	29.3	28.0	26.6	24.6	22.7	19.8	13.5													
		30							33.0	31.7	30.4	29.2	27.8	26.2	24.5	22.1	19.7	16.4	9.3											
		40							32.8	31.5	30.3	29.0	27.5	26.0	24.0	21.9	19.0	16.1	12.4	4.9										
		50							32.6	31.3	30.0	28.7	27.4	25.7	23.8	21.3	18.8	15.3	12.0	8.2	2.2									
Shut-off psi									170	161	152	144	135	126	118	109	100	92	83	74	66	48								
25S50-26	5.0	0													32.5	30.3	28.0	25.3	19.9	10.2										
		20													32.3	30.8	28.6	25.9	22.5	15.8	5.0									
		30													32.1	31.3	29.9	27.7	24.7	20.8	13.5	2.5								
		40													32.0	31.3	30.5	29.1	26.7	23.3	18.9	11.0								
		50													32.7	31.8	31.2	30.4	29.7	28.2	25.5	21.8	16.8	8.5						
Shut-off psi														253	245	236	227	219	210	193	167	141	115	80	37					

See 25S performance curves for higher head models.

Specifications are subject to change without notice.

These values are approximate. For more precise values, see the performance curves in section 6. [Curve charts and technical data.](#)

5. Performance curves and technical data

How to read the curve charts

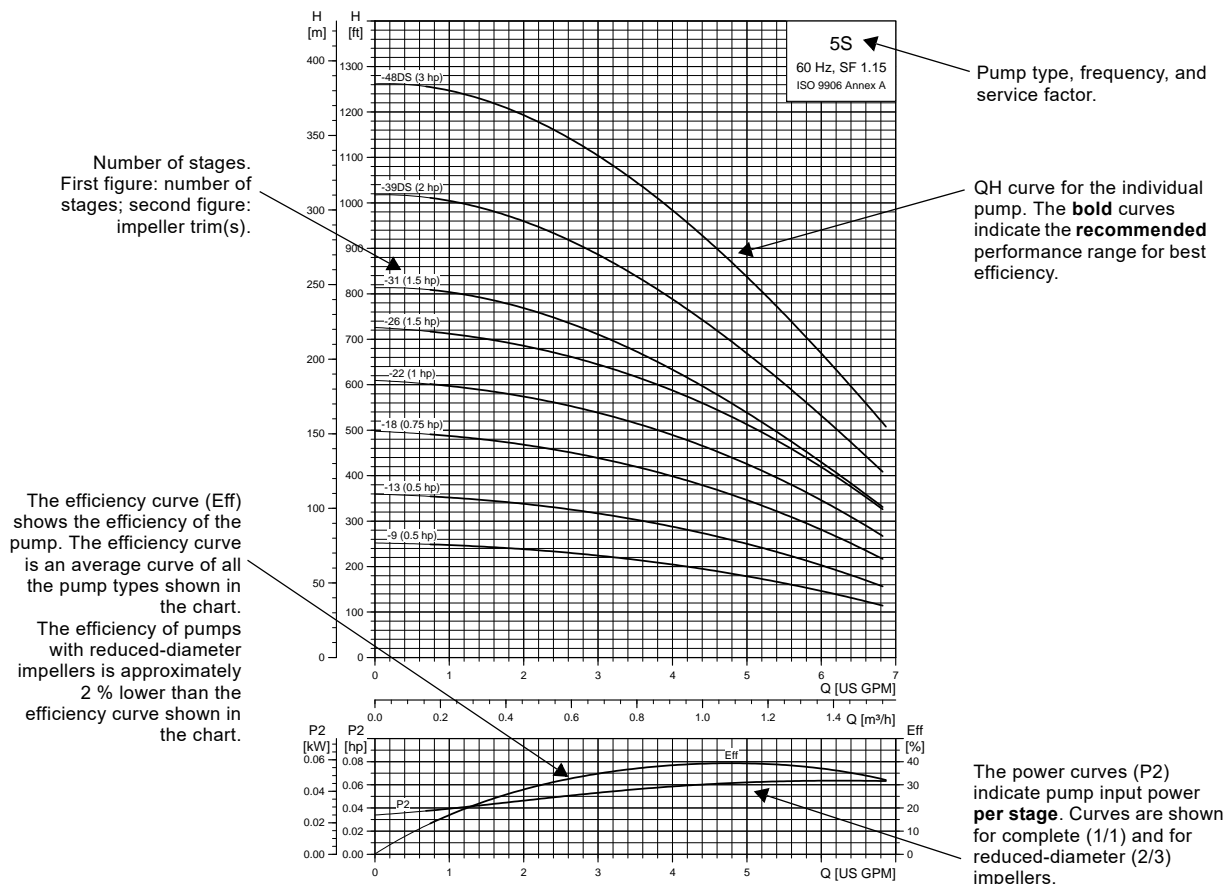

TM05 0229 10112

Curve conditions

The conditions below apply to the curves shown in section 6. *Curve charts and technical data* on pages 29-105:

General

- Curve tolerances according to ISO 9906, Annex A.
- The performance curves show pump performance at actual speed, cf. standard motor range. The motor speeds are listed in the data tables in section 6. *Curve charts and technical data*.
- The measurements were made with airless water at a temperature of 68 °F (20 °C). The curves apply to a kinematic viscosity of 1 mm²/s (1 cSt). When pumping liquids with a density higher than that of water, use motors with correspondingly higher outputs.
- The **bold** curves indicate the recommended performance range.
- The performance curves are inclusive of possible losses such as check valve loss.
- **Pump rpm:** The curves include the actual motor rpm. The actual motor rpm is listed in the data charts in section 6. *Curve charts and technical data*.
- **Q/H:** The curves are inclusive of valve and inlet losses at the actual speed. Operation without check valve will increase the actual head at rated performance by 1.6 to 3.3 ft (0.5 to 1.0 m).
- **NPSH:** The curve is inclusive of pressure loss in the suction interconnector and shows required inlet pressure.
- **Power curve:** P₂ shows pump power input [Hp] at the actual speed of each individual pump size.
- **Efficiency curve:** Eta shows pump stage efficiency. If Eta for the actual pump size is needed, please consult Grundfos Product Center.

6. Curve charts and technical data

4" and larger wells

SP 5S (5 gpm)

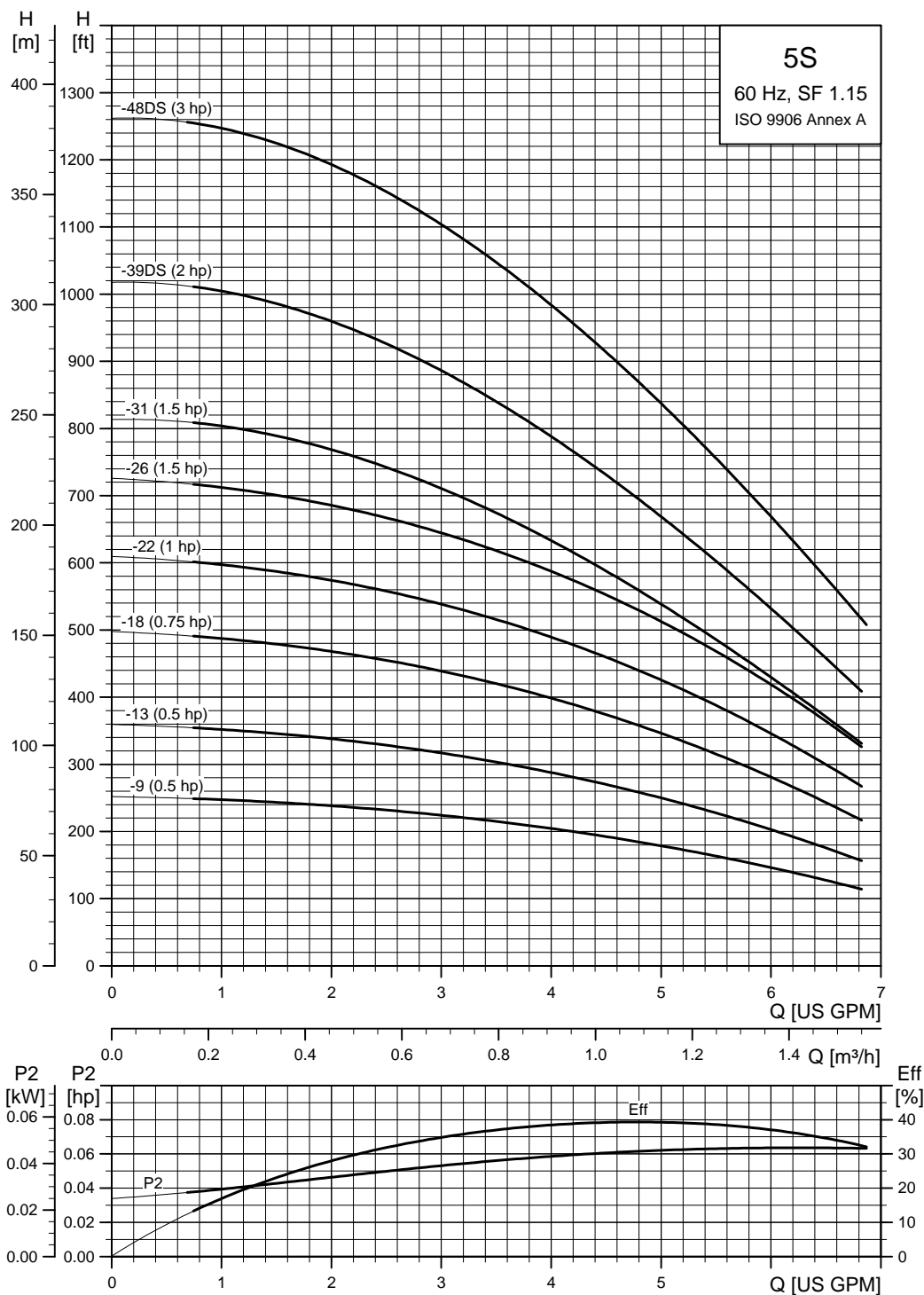

TM05 0229 2112

4" and larger wells - continued

SP 5S (5 gpm) pump with 4" motor

Pump model	Nom. head [ft]	Motor				Dimensions [in (mm)]					Net weight (complete) [lb]		
		Ph	Volts [V]	[Hp]	[rpm]	A	B	C	D	E			
5S, motor diameter 4-inch, 2-wire motor, 60 Hz - rated flow rate 5 gpm (1" NPT)													
5S05-9	184	1	230	0.5	■	3517	24.57 (624)	11.03 (280)	13.55 (344)	3.74 (95)	3.98 (101)	21.6	
5S05-13	258	1	115	0.5	■	3360	27.88 (708)	11.03 (280)	16.86 (428)	3.74 (95)	3.98 (101)	26.9	
			230	0.5	■	3474	27.88 (708)	11.03 (280)	16.86 (428)	3.74 (95)	3.98 (101)	26.1	
5S07-18	357	1	230	0.75	■	3465	32.60 (828)	11.62 (295)	20.99 (533)	3.74 (95)	3.98 (101)	29.7	
5S10-22	439	1	230	1	■	3400	36.50 (927)	12.21 (310)	24.30 (617)	3.74 (95)	3.98 (101)	32.4	
5S15-26	529	1	230	1.5	■	3439	41.30 (1049)	13.71 (348)	27.60 (701)	3.74 (95)	3.98 (101)	41.4	
5S15-31	585	1	230	1.5	■	3410	47.21 (1199)	13.71 (348)	33.51 (851)	3.74 (95)	3.98 (101)	47.7	
5S, motor diameter 4-inch, 3-wire motor, 60 Hz - rated flow rate 5 gpm (1" NPT)													
5S05-9	184	1	230	0.5	■	3450	24.57 (624)	11.03 (280)	13.55 (344)	3.74 (95)	3.98 (101)	22.5	
5S05-13	258	1	115	0.5	■	3382	27.88 (708)	11.03 (280)	16.86 (428)	3.74 (95)	3.98 (101)	26.9	
			230	0.5	■	3352	27.88 (708)	11.03 (280)	16.86 (428)	3.74 (95)	3.98 (101)	25.2	
5S07-18	357	1	230	0.75	■	3346	32.60 (828)	11.62 (295)	20.99 (533)	3.74 (95)	3.98 (101)	28.8	
5S10-22	439	1	230	1	■	3379	36.50 (927)	12.21 (310)	24.30 (617)	3.74 (95)	3.98 (101)	32.4	
5S15-26	529	3	1	230	1.5	■	3459	41.30 (1049)	13.71 (348)	27.60 (701)	3.74 (95)	3.98 (101)	37.8
			230	1.5	■	3465	39.81 (1011)	12.21 (310)	27.60 (701)	3.74 (95)	3.98 (101)	38.7	
			460	1.5	■	3465	39.81 (1011)	12.21 (310)	27.60 (701)	3.74 (95)	3.98 (101)	38.7	
5S15-31	585	3	1	230	1.5	■	3423	47.21 (1199)	13.71 (348)	33.51 (851)	3.74 (95)	3.98 (101)	47.7
			230	1.5	■	3437	45.71 (1161)	12.21 (310)	33.51 (851)	3.74 (95)	3.98 (101)	45.0	
			460	1.5	■	3437	45.71 (1161)	12.21 (310)	33.51 (851)	3.74 (95)	3.98 (101)	45.0	
5S20-39DS	730	3	1	230	2	●	3428	59.61 (1514)	19.49 (495)	40.12 (1019)	3.74 (95)	4.25 (108)	57.6
			230	2	■	3426	53.82 (1367)	13.71 (348)	40.12 (1019)	3.74 (95)	4.25 (108)	54.0	
			460	2	■	3426	53.82 (1367)	13.71 (348)	40.12 (1019)	3.74 (95)	4.25 (108)	54.0	
5S30-48DS	909	3	1	230	3	●	3450	70.16 (1782)	22.60 (574)	47.56 (1208)	3.74 (95)	4.25 (108)	77.4
			208	3	●	3485	65.56 (1665)	18.00 (457)	47.56 (1208)	3.74 (95)	4.25 (108)	77.4	
			230	3	●	3485	65.56 (1665)	18.00 (457)	47.56 (1208)	3.74 (95)	4.25 (108)	77.4	
			460	3	●	3485	65.56 (1665)	18.00 (457)	47.56 (1208)	3.74 (95)	4.25 (108)	77.4	

Notes:

Control box is required for 3-wire, single-phase applications. Data does not include control box.

DS designation = Built into sleeve, 1 - 1/2" NPT, 6" minimum well diameter.

Performance conforms to ISO 9906: 1999 (E) Annex A. Minimum submergence is 2 ft (0.6 m).

- MS 402 motor.
- MS 4000 motor.

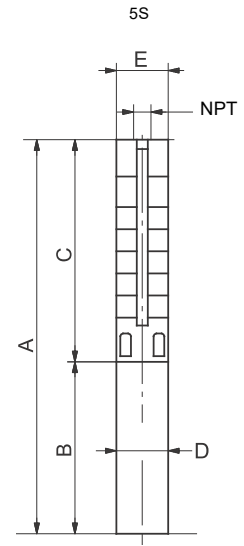

E = Maximum diameter of pump including cable guard and motor.

TN05 0204 0711

4" and larger wells - continued

SP 7S (7 gpm)

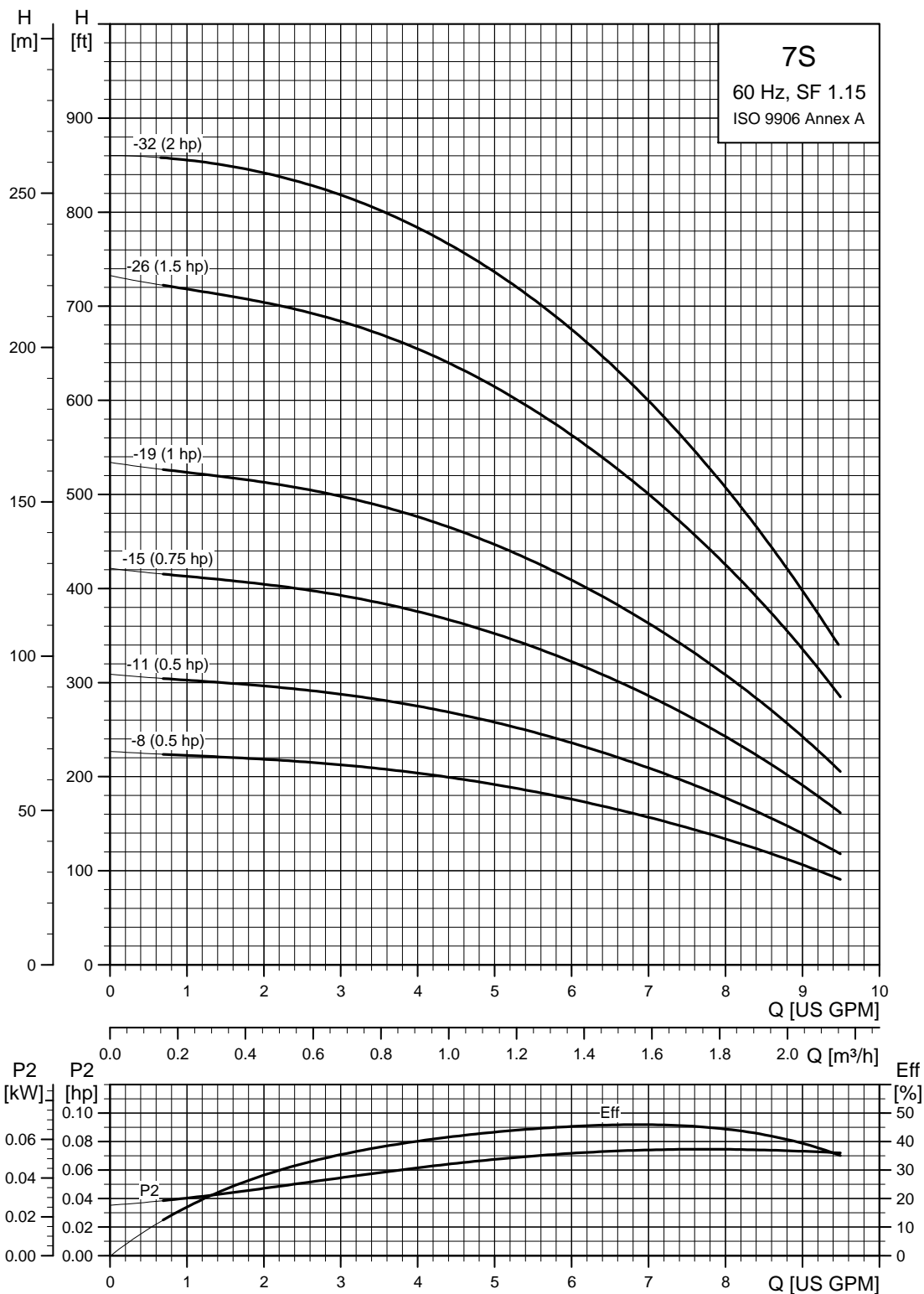

TM05 0982 2112

4" and larger wells - continued

SP 7S (7 gpm) pump with 4" motor

Pump model	Nom. head [ft]	Motor				Dimensions [in (mm)]					Net weight (complete) [lb]	
		Ph	Volts [V]	[Hp]	[rpm]	A	B	C	D	E		
7S, motor diameter 4-inch, 2-wire motor, 60 Hz - rated flow rate 7 gpm (1" NPT)												
7S05-8	164	1	230	.5	■	3512	23.75 (603)	11.03 (280)	12.72 (323)	3.74 (95)	3.98 (101)	21.6
7S05-11	222	1	115	.5	■	3359	26.23 (666)	11.03 (280)	15.20 (386)	3.74 (95)	3.98 (101)	29.7
			230	.5	■	3472	26.23 (666)	11.03 (280)	15.20 (386)	3.74 (95)	3.98 (101)	24.3
7S07-15	303	1	230	.75	■	3467	30.12 (765)	11.62 (295)	18.51 (470)	3.74 (95)	3.98 (101)	29.7
7S10-19	385	1	230	1	■	3394	34.02 (864)	12.21 (310)	21.82 (554)	3.74 (95)	3.98 (101)	32.4
7S15-26	525	1	230	1.5	■	3408	41.3 (1049)	13.71 (348)	27.60 (701)	3.74 (95)	3.98 (101)	41.4
7S, motor diameter 4-inch, 3-wire motor, 60 Hz - rated flow rate 7 gpm (1" NPT)												
7S05-8	164	1	230	.5	■	3438	23.75 (603)	11.03 (280)	12.72 (323)	3.74 (95)	3.98 (101)	21.6
7S05-11	222	1	115	.5	■	3380	26.23 (666)	11.03 (280)	15.20 (386)	3.74 (95)	3.98 (101)	21.6
			230	.5	■	3349	26.23 (666)	11.03 (280)	15.20 (386)	3.74 (95)	3.98 (101)	30.6
7S07-15	303	1	230	.75	■	3349	30.12 (765)	11.62 (295)	18.51 (470)	3.74 (95)	3.98 (101)	27.9
7S10-19	385	1	230	1	■	3369	34.02 (864)	12.21 (310)	21.82 (554)	3.74 (95)	3.98 (101)	39.6
			230	1.5	■	3419	41.30 (1049)	13.71 (348)	27.60 (701)	3.74 (95)	3.98 (101)	38.7
7S15-26	525	3	230	1.5	■	3435	39.81 (1011)	12.21 (310)	27.60 (701)	3.74 (95)	3.98 (101)	38.7
			460	1.5	■	3435	39.81 (1011)	12.21 (310)	27.60 (701)	3.74 (95)	3.98 (101)	38.7
			1	230	2	●	3590	52.05 (1322)	19.49 (495)	32.56 (827)	3.74 (95)	3.98 (101)
7S20-32	630	3	230	2	■	3596	46.26 (1175)	13.71 (348)	32.56 (827)	3.74 (95)	3.98 (101)	48.5
			460	2	■	3596	46.26 (1175)	13.71 (348)	32.56 (827)	3.74 (95)	3.98 (101)	48.5

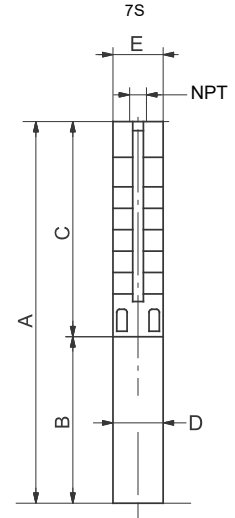

TM05 0204 0711

E = Maximum diameter of pump including cable guard and motor.

Notes:

Control box is required for 3-wire, single-phase applications. Data does not include control box.

DS designation = Built into sleeve, 1 - 1/2" NPT, 6" minimum well diameter.

Performance conforms to ISO 9906: 1999 (E) Annex A. Minimum submergence is 2 ft (0.6 m).

- MS 402 motor.
- MS 4000 motor.

4" and larger wells - continued

SP 10S (10 gpm)

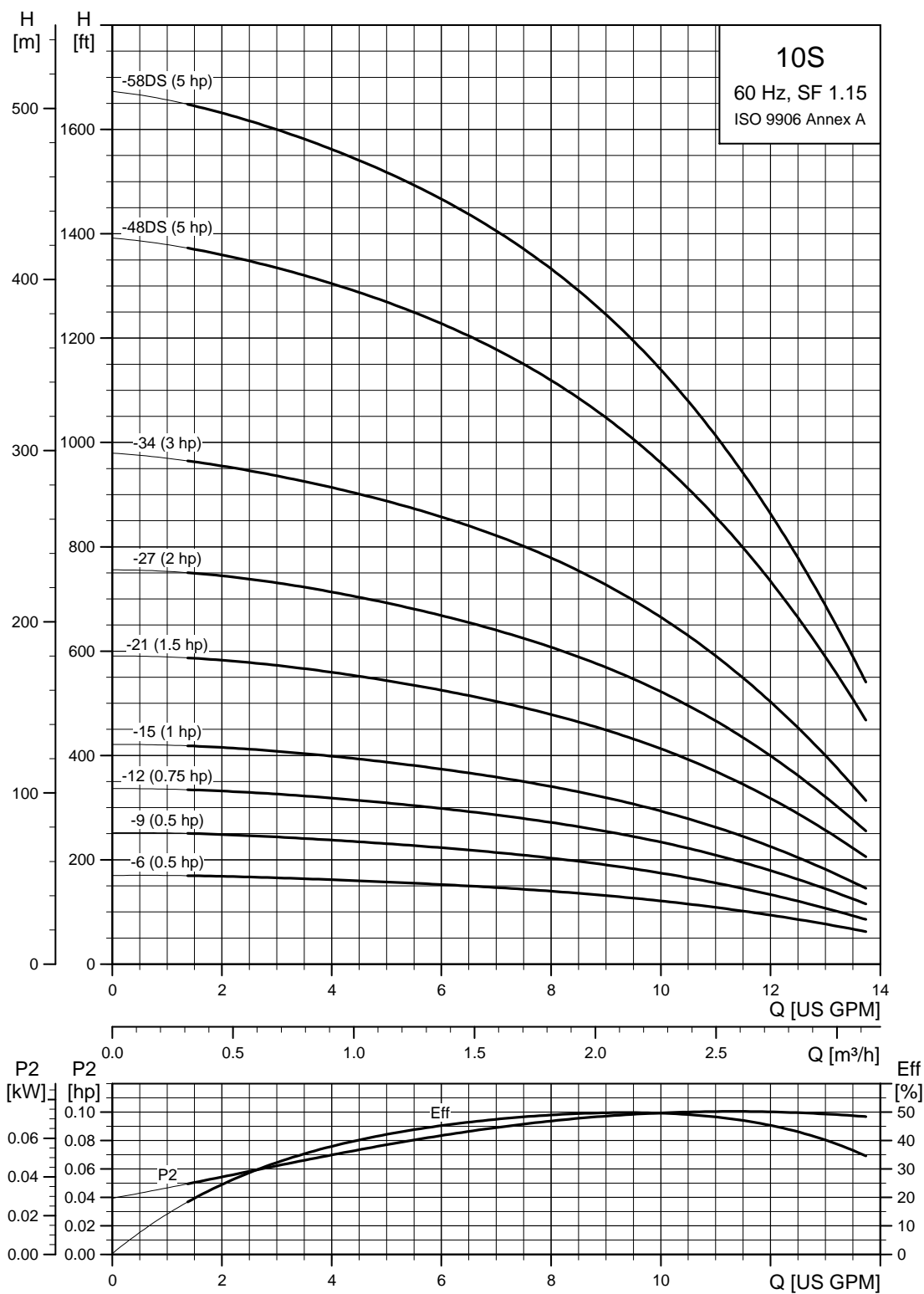

TM05 0230 1812

4" and larger wells - continued

SP 10S (10 gpm) pump with 4" motor

Pump model	Nom. head [ft]	Motor				Dimensions [in (mm)]					Net weight (complete) [lb]		
		Ph	Volts [V]	[Hp]	[rpm]	A	B	C	D	E			
10S, motor diameter 4-inch, 2-wire motor, 60 Hz - rated flow rate 10 gpm (1.25" NPT)													
10S05-6	126	1	230	.5	■	3454	22.05 (560)	10.99 (279)	11.07 (281)	3.74 (95)	3.98 (101)	20.7	
10S05-9	185	1	115	.5	■	3336	24.53 (623)	10.99 (279)	13.55 (344)	3.74 (95)	3.98 (101)	24.3	
			230	.5	■	3457	24.53 (623)	10.99 (279)	13.55 (344)	3.74 (95)	3.98 (101)	23.4	
10S07-12	246	1	230	.75	■	3453	27.60 (701)	11.58 (294)	16.03 (407)	3.74 (95)	3.98 (101)	24.3	
10S10-15	309	1	230	1	■	3382	30.67 (779)	12.17 (309)	18.51 (470)	3.74 (95)	3.98 (101)	29.7	
10S15-21	433	1	230	1.5	■	3392	37.17 (944)	13.71 (348)	23.47 (596)	3.74 (95)	3.98 (101)	35.1	
10S, motor diameter 4-inch, 3-wire motor, 60 Hz - rated flow rate 10 gpm (1.25" NPT)													
10S05-6	126	1	230	.5	■	3279	24.77 (629)	13.71 (348)	11.07 (281)	3.74 (95)	3.98 (101)	21.6	
10S05-9	185	1	115	.5	■	3350	24.53 (623)	10.99 (279)	13.55 (344)	3.74 (95)	3.98 (101)	25.4	
			230	.5	■	3313	24.53 (623)	10.99 (279)	13.55 (344)	3.74 (95)	3.98 (101)	24.3	
10S07-12	246	1	230	.75	■	3320	27.60 (701)	11.58 (294)	16.03 (407)	3.74 (95)	3.98 (101)	28.8	
10S10-15	309	1	230	1	■	3348	30.67 (779)	12.17 (309)	18.51 (470)	3.74 (95)	3.98 (101)	29.7	
			1	230	1.5	■	3398	37.17 (944)	13.71 (348)	23.47 (596)	3.74 (95)	3.98 (101)	35.1
10S15-21	433	3	230	1.5	■	3419	35.63 (905)	12.17 (309)	23.47 (596)	3.74 (95)	3.98 (101)	32.4	
			460	1.5	■	3419	35.63 (905)	12.17 (309)	23.47 (596)	3.74 (95)	3.98 (101)	36.0	
			1	230	2	●	3400	47.92 (1217)	19.49 (495)	28.43 (722)	3.74 (95)	3.98 (101)	45.9
10S20-27	554	3	230	2	■	3399	42.13 (1070)	13.71 (348)	28.43 (722)	3.74 (95)	3.98 (101)	44.1	
			460	2	■	3399	42.13 (1070)	13.71 (348)	28.43 (722)	3.74 (95)	3.98 (101)	44.1	
			1	230	3	●	3418	58.59 (1488)	22.6 (574)	35.99 (914)	3.74 (95)	3.98 (101)	81.9
10S30-34	716	3	208	3	●	3465	53.98 (1371)	18.00 (457)	35.99 (914)	3.74 (95)	3.98 (101)	74.7	
			230	3	●	3465	53.98 (1371)	18.00 (457)	35.99 (914)	3.74 (95)	3.98 (101)	74.7	
			460	3	●	3465	53.98 (1371)	18.00 (457)	35.99 (914)	3.74 (95)	3.98 (101)	74.7	
10S50-48DS	1020	3	1	230	5	●	3476	74.18 (1884)	26.62 (676)	47.56 (1208)	3.74 (95)	4.25 (108)	103.5
			208	5	●	3499	70.16 (1782)	22.60 (574)	47.56 (1208)	3.74 (95)	4.25 (108)	103.5	
			230	5	●	3499	70.16 (1782)	22.60 (574)	47.56 (1208)	3.74 (95)	4.25 (108)	103.5	
10S50-58DS	1225	3	1	230	5	●	3441	89.49 (2272)	26.62 (676)	62.88 (1597)	3.74 (95)	4.25 (108)	132.3
			208	5	●	3473	85.48 (2171)	22.60 (574)	62.88 (1597)	3.74 (95)	4.25 (108)	132.3	
			230	5	●	3473	85.48 (2171)	22.60 (574)	62.88 (1597)	3.74 (95)	4.25 (108)	132.3	
			460	5	●	3470	85.48 (2171)	22.60 (574)	62.88 (1597)	3.74 (95)	4.25 (108)	132.3	

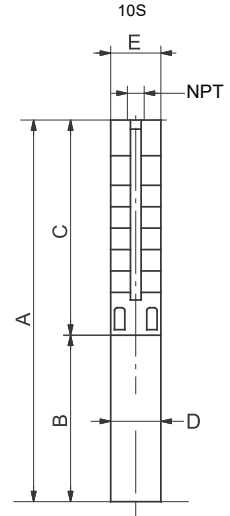

TM05 0204 0711

E = Maximum diameter of pump including cable guard and motor.

Notes:

Control box is required for 3-wire, single-phase applications. Data does not include control box.

DS designation = Built into sleeve, 1 - 1/2" NPT, 6" minimum well diameter.

Performance conforms to ISO 9906. 1999 (E) Annex A. Minimum submergence is 2 ft (0.6 m).

- MS 402 motor.
- MS 4000 motor.

4" and larger wells - continued

SP 16S (16 gpm)

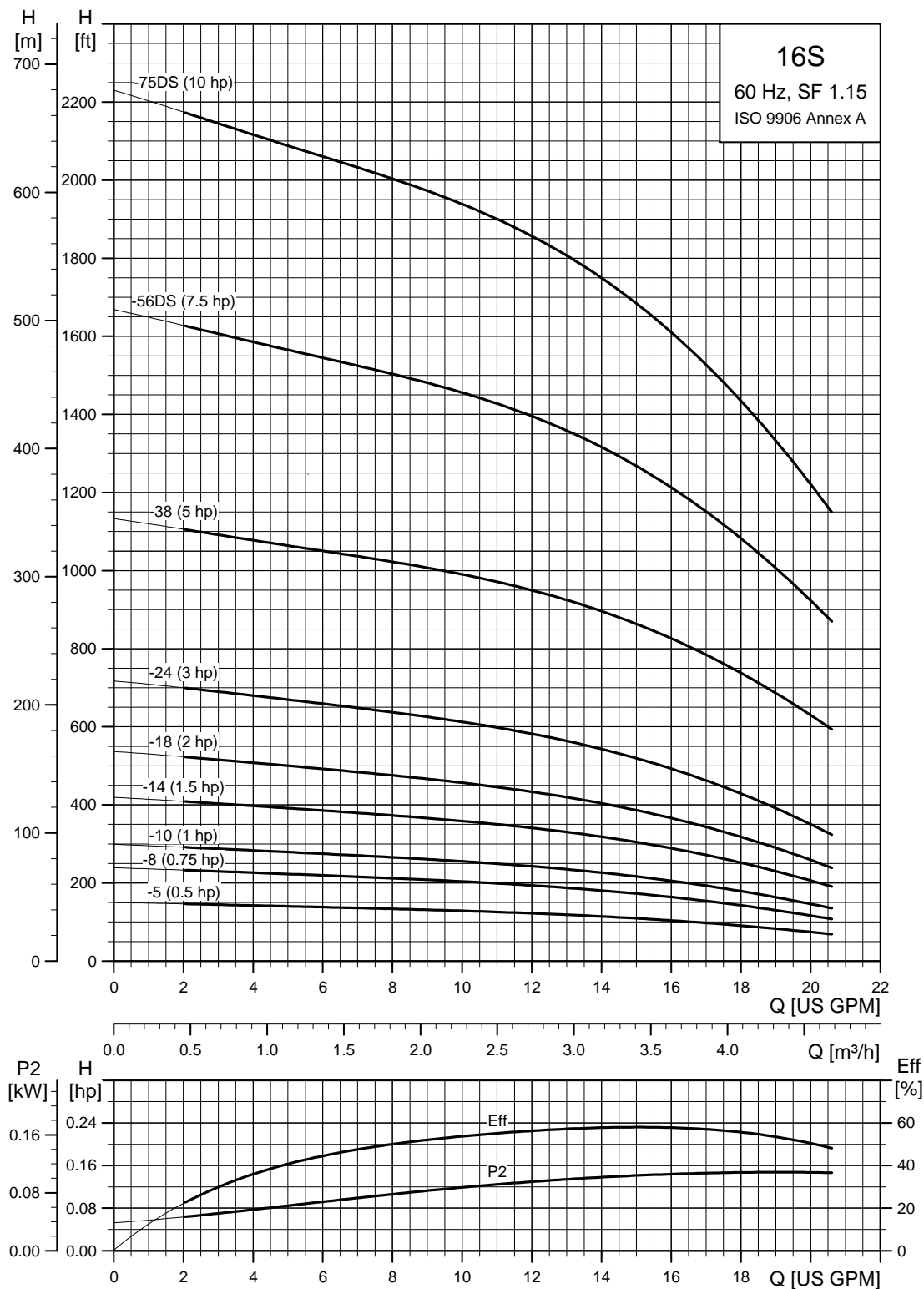

TM05 0231 0112

4" and larger wells - continued

SP 16S (16 gpm) pump with 4", 6" motors

Pump model	Nom. head [ft]	Motor				Dimensions [in (mm)]					Net weight (complete) [lb]		
		Ph	Volts [V]	[Hp]	[rpm]	A	B	C	D	E			
16S, motor diameter 4-inch, 2-wire motor, 60 Hz - rated flow rate 16 gpm (1.25" NPT)													
16S05-5	112	1	115	.5	■	3391	21.26 (540)	11.03 (280)	10.24 (260)	3.74 (95)	3.98 (101)	21.6	
			230	.5	■	3393	21.26 (540)	11.03 (280)	10.24 (260)	3.74 (95)	3.98 (101)	23.4	
16S07-8	177	1	230	.75	■	3464	24.34 (618)	11.62 (295)	12.72 (323)	3.74 (95)	3.98 (101)	24.3	
16S10-10	223	1	230	1	■	3394	26.58 (675)	12.21 (310)	14.38 (365)	3.74 (95)	3.98 (101)	27.9	
16S15-14	313	1	230	1.5	■	3403	31.38 (797)	13.71 (348)	17.68 (449)	3.74 (95)	3.98 (101)	36.0	
16S, motor diameter 4-inch, 3-wire motor, 60 Hz - rated flow rate 16 gpm (1.25" NPT)													
16S05-5	112	1	115	.5	■	3419	21.26 (540)	11.03 (280)	10.24 (260)	3.74 (95)	3.98 (101)	21.6	
			230	.5	■	3396	21.26 (540)	11.03 (280)	10.24 (260)	3.74 (95)	3.98 (101)	21.6	
16S07-8	177	1	230	.75	■	3343	24.34 (618)	11.62 (295)	12.72 (323)	3.74 (95)	3.98 (101)	27.0	
16S10-10	223	1	230	1	■	3369	26.58 (675)	12.21 (310)	14.38 (365)	3.74 (95)	3.98 (101)	27.9	
16S15-14	313	3	230	1.5	■	3414	31.38 (797)	13.71 (348)	17.68 (449)	3.74 (95)	3.98 (101)	32.4	
			230	1.5	■	3430	29.89 (759)	12.21 (310)	17.68 (449)	3.74 (95)	3.98 (101)	28.8	
16S20-18	397	3	460	1.5	■	3430	29.89 (759)	12.21 (310)	17.68 (449)	3.74 (95)	3.98 (101)	28.8	
			1	230	2	●	3414	40.48 (1028)	19.49 (495)	20.99 (533)	3.74 (95)	3.98 (101)	36.0
16S20-18	397	3	230	2	■	3413	34.69 (881)	13.71 (348)	20.99 (533)	3.74 (95)	3.98 (101)	36.0	
			460	2	■	3413	34.69 (881)	13.71 (348)	20.99 (533)	3.74 (95)	3.98 (101)	36.0	
16S30-24	533	3	1	230	3	●	3416	48.55 (1233)	22.60 (574)	25.95 (659)	3.74 (95)	3.98 (101)	62.1
			208	3	●	3464	43.94 (1116)	18.00 (457)	25.95 (659)	3.74 (95)	3.98 (101)	57.6	
16S30-24	533	3	230	3	●	3464	43.94 (1116)	18.00 (457)	25.95 (659)	3.74 (95)	3.98 (101)	57.6	
			460	3	●	3464	43.94 (1116)	18.00 (457)	25.95 (659)	3.74 (95)	3.98 (101)	57.6	
16S50-38	832	3	1	230	5	●	3449	65.91 (1674)	26.62 (676)	39.30 (998)	3.74 (95)	3.98 (101)	97.2
			208	5	●	3479	62.01 (1575)	22.72 (577)	39.30 (998)	3.74 (95)	3.98 (101)	90.0	
16S50-38	832	3	230	5	●	3479	62.01 (1575)	22.72 (577)	39.30 (998)	3.74 (95)	3.98 (101)	90.0	
			460	5	●	3476	62.01 (1575)	22.72 (577)	39.30 (998)	3.74 (95)	3.98 (101)	90.0	
SP 16S, motor diameter 6 inch, 60 Hz - rated flow rate 16 gpm (1.25" NPT)													
-	-	3	208	5	▲	3480	-	23.51 (597)	-	5.50 (139.5)	-	80.0	
			230	5	▲	3510	-	23.51 (597)	-	5.50 (139.5)	-	80.0	
			460	5	▲	3500	-	23.51 (597)	-	5.50 (139.5)	-	80.0	
16S75-56DS	1224	3	208	7.5	▲	3478	92.28 (2344)	23.51 (597)	68.78 (1747)	5.63 (143)	5.51 (140)	165.1	
			230	7.5	▲	3478	92.28 (2344)	23.51 (597)	68.78 (1747)	5.63 (143)	5.51 (140)	165.1	
			460	7.5	▲	3491	92.28 (2344)	23.51 (597)	68.78 (1747)	5.63 (143)	5.51 (140)	165.1	
16S100-75DS	1636	3	460	10	▲	3482	109.18 (2773)	24.69 (627)	84.49 (2146)	5.63 (143)	5.51 (140)	190.0	

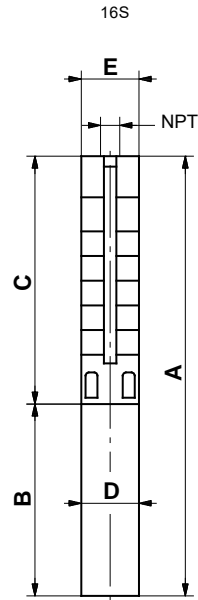

TM00 8521 3196

E = Maximum diameter of pump including cable guard and motor.

Notes:

Control box is required for 3-wire, single-phase applications. Data does not include control box.

DS designation = Built into sleeve, 1 - 1/2" NPT, 6" minimum well diameter.

Performance conforms to ISO 9906. 1999 (E) Annex A. Minimum submergence is 2 ft (0.6 ft).

- MS 402 motor.
- MS 4000 motor.
- ▲ MS 6000C motor.

4" and larger wells - continued

SP 25S (25 gpm)

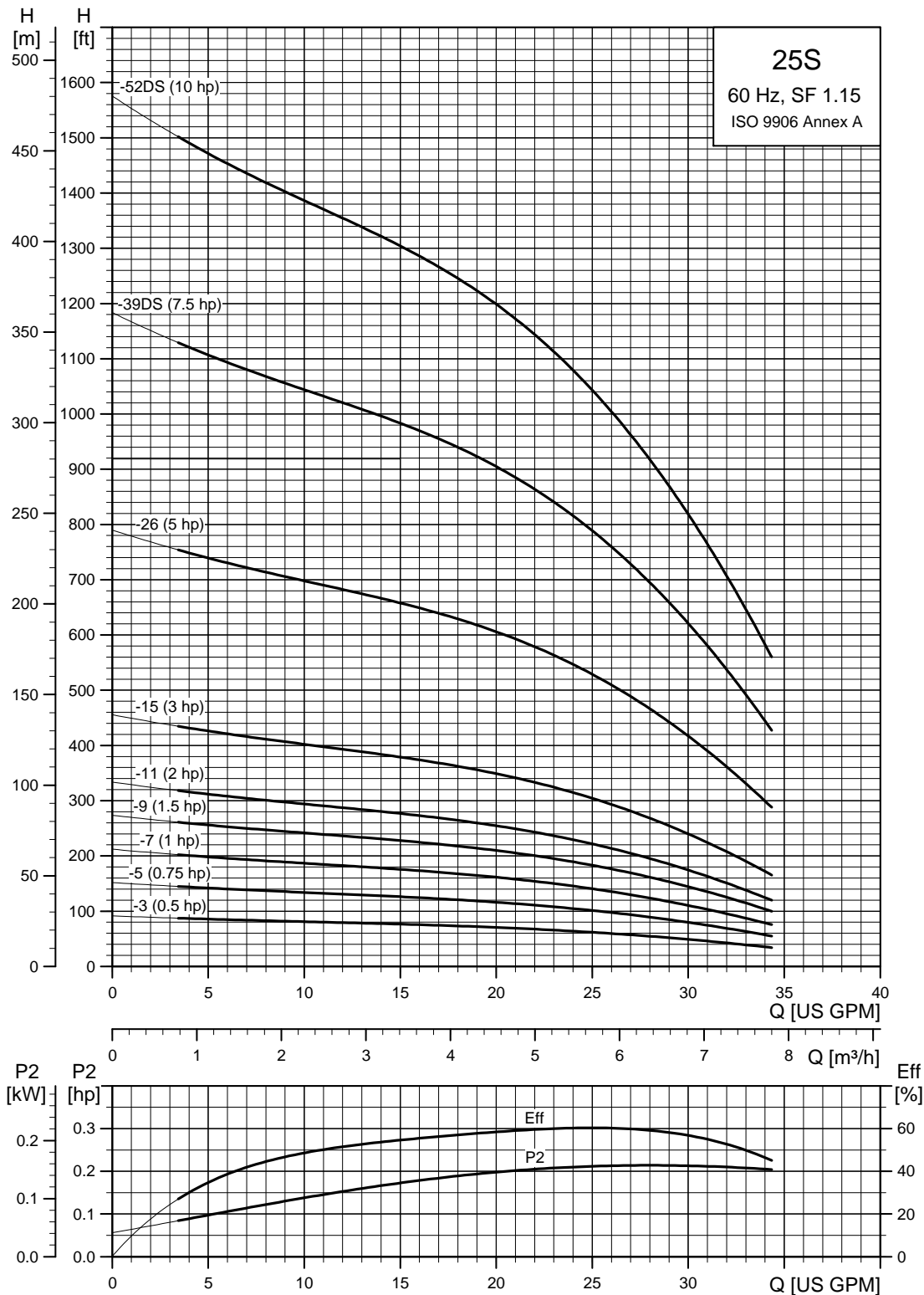

TM05 0232 1812

4" and larger wells - continued

SP 25S (25 gpm) pump with 4", 6" inch motors

Pump model	Nom. head [ft]	Motor				Dimensions [in (mm)]					Net weight (complete) [lb]		
		Ph	Volts [V]	[Hp]	[rpm]	A	B	C	D	E			
25S, motor diameter 4-inch, 2-wire motor, 60 Hz - rated flow rate 25 gpm (1.5" NPT)													
25S05-3	64	1	115	.5	■	3411	19.61 (498)	11.03 (280)	8.59 (218)	3.74 (95)	3.98 (101)	21.6	
			230	.5	■	3505	19.61 (498)	11.03 (280)	8.59 (218)	3.74 (95)	3.98 (101)	21.6	
25S07-5	105	1	230	.75	■	3474	21.86 (555)	11.62 (295)	10.24 (260)	3.74 (95)	3.98 (101)	23.4	
25S10-7	146	1	230	1	■	3383	24.10 (612)	12.21 (310)	11.89 (302)	3.74 (95)	3.98 (101)	25.2	
25S15-9	189	1	230	1.5	■	3410	27.25 (692)	13.71 (348)	13.55 (344)	3.74 (95)	3.98 (101)	28.8	
25S, motor diameter 4-inch, 3-wire motor, 60 Hz - rated flow rate 25 gpm (1.5" NPT)													
25S05-3	64	1	115	.5	■	3441	19.61 (498)	11.03 (280)	8.59 (218)	3.74 (95)	3.98 (101)	21.6	
			230	.5	■	3423	19.61 (498)	11.03 (280)	8.59 (218)	3.74 (95)	3.98 (101)	21.6	
25S07-5	105	1	230	.75	■	3365	21.86 (555)	11.62 (295)	10.24 (260)	3.74 (95)	3.98 (101)	23.4	
25S10-7	146	1	230	1	■	3349	24.10 (612)	12.21 (310)	11.89 (302)	3.74 (95)	3.98 (101)	25.2	
			230	1.5	■	3422	27.25 (692)	13.71 (348)	13.55 (344)	3.74 (95)	3.98 (101)	29.7	
25S15-9	189	3	230	1.5	■	3437	25.75 (654)	12.21 (310)	13.55 (344)	3.74 (95)	3.98 (101)	27.0	
			460	1.5	■	3437	25.75 (654)	12.21 (310)	13.55 (344)	3.74 (95)	3.98 (101)	28.8	
25S20-11	229	1	230	2	●	3434	34.69 (881)	19.49 (495)	15.20 (386)	3.74 (95)	3.98 (101)	33.1	
			230	2	■	3431	28.90 (734)	13.71 (348)	15.20 (386)	3.74 (95)	3.98 (101)	37.0	
			460	2	■	3431	28.90 (734)	13.71 (348)	15.20 (386)	3.74 (95)	3.98 (101)	33.3	
25S30-15	314	3	230	3	●	3432	41.11 (1044)	22.60 (574)	18.51 (470)	3.74 (95)	3.98 (101)	61.2	
			208	3	●	3474	36.50 (927)	18.00 (457)	18.51 (470)	3.74 (95)	3.98 (101)	53.1	
			230	3	●	3474	36.50 (927)	18.00 (457)	18.51 (470)	3.74 (95)	3.98 (101)	53.1	
25S50-26	546	3	460	3	●	3474	36.50 (927)	18.00 (457)	18.51 (470)	3.74 (95)	3.98 (101)	53.1	
			1	230	5	●	3449	54.22 (1377)	26.62 (676)	27.60 (701)	3.74 (95)	3.98 (101)	72.9
			208	5	●	3479	50.32 (1278)	22.72 (577)	27.60 (701)	3.74 (95)	3.98 (101)	72.9	
25S75-39DS	815	3	230	5	●	3479	50.32 (1278)	22.72 (577)	27.60 (701)	3.74 (95)	3.98 (101)	72.9	
			460	5	●	3476	50.32 (1278)	22.72 (577)	27.60 (701)	3.74 (95)	3.98 (101)	72.9	
			208	5	●	3476	50.32 (1278)	22.72 (577)	27.60 (701)	3.74 (95)	3.98 (101)	72.9	
SP 25S, motor diameter 6 inch, 60 Hz - rated flow rate 25 gpm (1.5" NPT)													
-	-	3	208	5	▲	3480	-	23.51 (597)	-	5.50 (139.5)	-	80.0	
			230	5	▲	3510	-	23.51 (597)	-	5.50 (139.5)	-	80.0	
			460	5	▲	3500	-	23.51 (597)	-	5.50 (139.5)	-	80.0	
25S75-39DS	815	3	208	7.5	▲	3475	66.06 (1678)	23.51 (597)	42.56 (1081)	5.63 (143)	5.43 (138)	122.1	
			230	7.5	▲	3475	66.06 (1678)	23.51 (597)	42.56 (1081)	5.63 (143)	5.43 (138)	122.1	
			460	7.5	▲	3488	66.06 (1678)	23.51 (597)	42.56 (1081)	5.63 (143)	5.43 (138)	122.1	
25S100-52DS	1082	3	460	10	▲	3480	90.17 (2290)	24.69 (627)	65.48 (1663)	5.63 (143)	5.51 (140)	163.1	

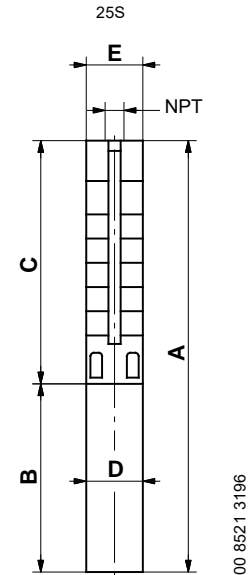

TM00 8521 3196

E = Maximum diameter of pump including cable guard and motor.

Notes:

Control box is required for 3-wire, single-phase applications. Data does not include control box.

DS designation = Built into sleeve, 1 - 1/2" NPT, 6" minimum well diameter.

Performance conforms to ISO 9906. 1999 (E) Annex A. Minimum submergence is 2 ft (0.6 m).

- MS 402 motor.
- MS 4000 motor.
- ▲ MS 6000C motor.

4" and larger wells - continued

SP 35S (35 gpm)

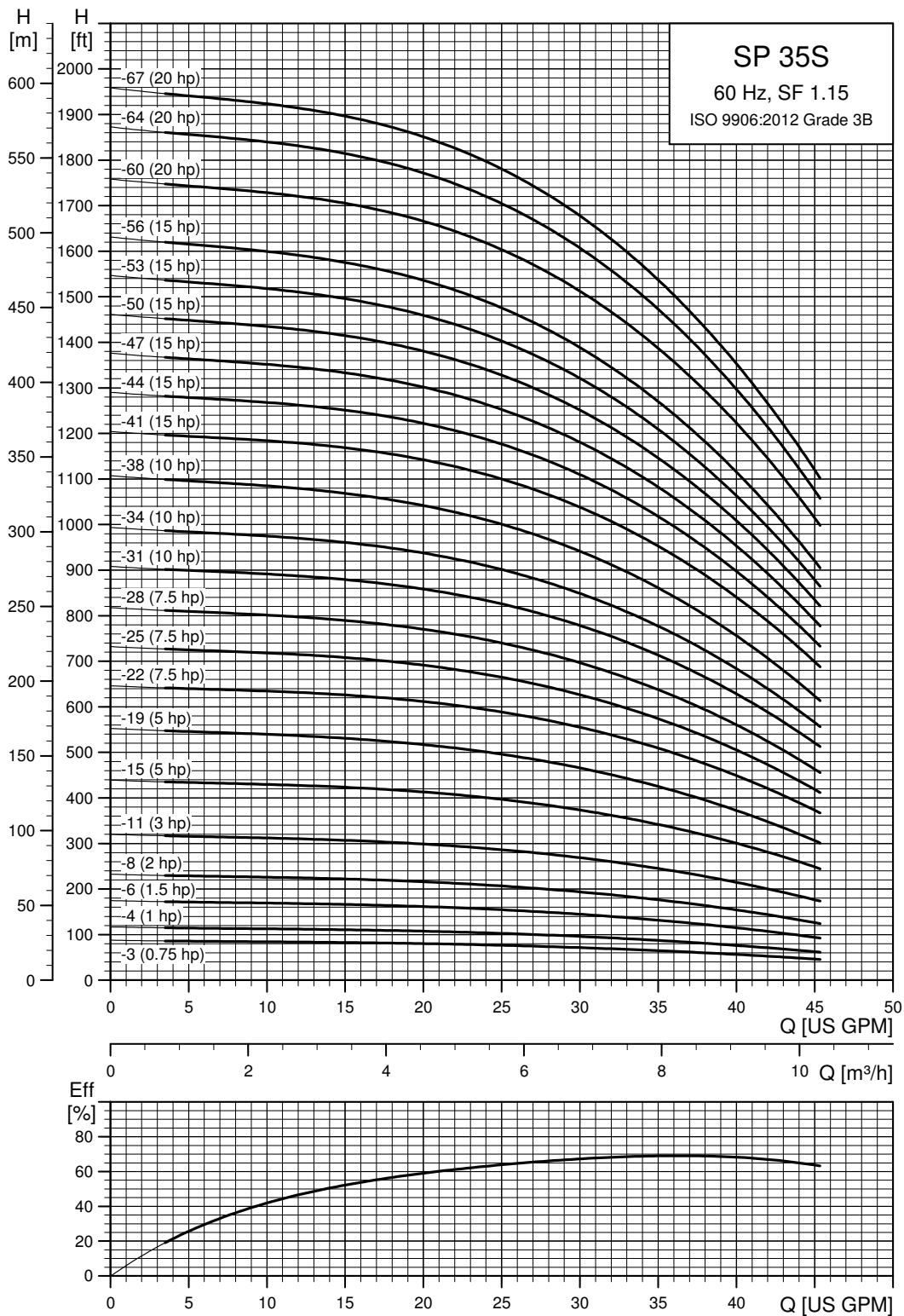

TM06 4614 3215

4" and larger wells - continued

SP 35S (35 gpm) pump power requirement (P2)

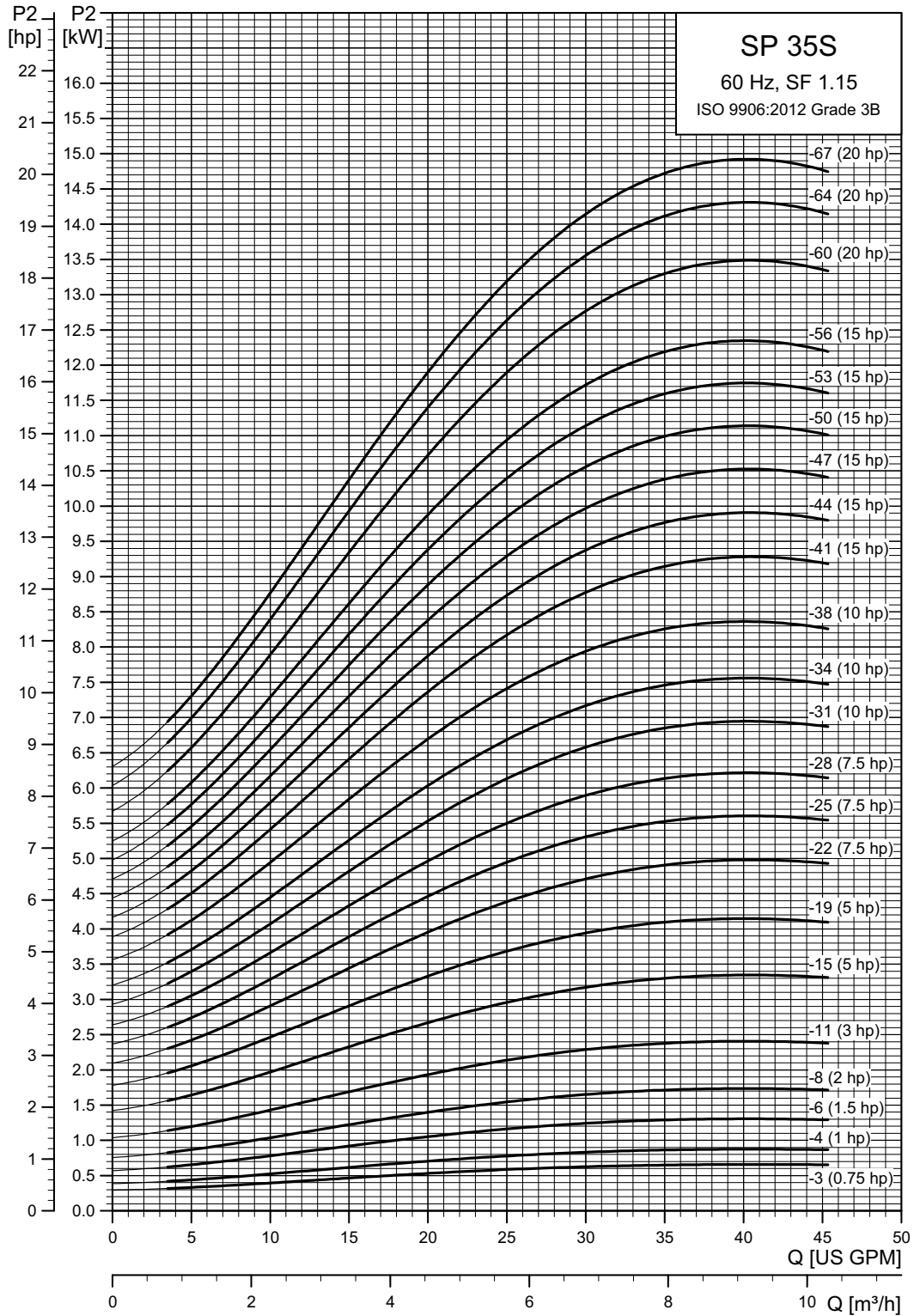

TM06 4615 3215

4" and larger wells - continued

SP 35S (35 gpm) pump with 4" motor

Pump model	Nom. head [ft]	Motor				Dimensions [in (mm)]					Net weight (complete) [lb]	
		Ph	Volts [V]	[Hp]	[rpm]	A	B	C	D	E		
35S - Motor diameter 4-inch, 3-wire motor, 60 Hz, rated flow rate 35 gpm (1 1/2" NPT)												
35S07-3	61	1	230	.75	■	3427	28.35 (720)	13.08 (332)	15.28 (388)	3.75 (95)	3.98 (101)	29.9
		3	230	.75	■	3439	26.97 (685)	11.70 (297)	15.28 (388)	3.75 (95)	3.98 (101)	26.9
		3	460	.75	■	3439	26.97 (685)	11.70 (297)	15.28 (388)	3.75 (95)	3.98 (101)	26.9
		3	575	.75	■	3428	26.97 (685)	11.70 (297)	15.28 (388)	3.75 (95)	3.98 (101)	26.9
35S10-4	82	1	230	1	■	3429	30.91 (785)	13.67 (347)	17.25 (438)	3.75 (95)	3.98 (101)	32.8
		3	230	1	■	3445	29.73 (755)	12.49 (317)	17.25 (438)	3.75 (95)	3.98 (101)	30.1
		3	460	1	■	3445	29.73 (755)	12.49 (317)	17.25 (438)	3.75 (95)	3.98 (101)	29.9
		3	575	1	■	3431	29.73 (755)	12.49 (317)	17.25 (438)	3.75 (95)	3.98 (101)	29.9
35S15-6	126	1	230	1.5	■	3442	36.42 (925)	15.24 (387)	21.19 (538)	3.75 (95)	3.98 (101)	39.1
		3	230	1.5	■	3451	34.85 (885)	13.67 (347)	21.19 (538)	3.75 (95)	3.98 (101)	35.5
		3	460	1.5	■	3451	34.85 (885)	13.67 (347)	21.19 (538)	3.75 (95)	3.98 (101)	35.5
		3	575	1.5	■	3427	34.85 (885)	13.67 (347)	21.19 (538)	3.75 (95)	3.98 (101)	35.3
35S20-8	168	1	230	2	●	3434	44.69 (1135)	19.57 (497)	25.12 (638)	3.75 (95)	3.98 (101)	57.3
		3	230	2	■	3432	40.36 (1025)	15.24 (387)	25.12 (638)	3.75 (95)	3.98 (101)	41.9
		3	460	2	■	3432	40.36 (1025)	15.24 (387)	25.12 (638)	3.75 (95)	3.98 (101)	42.1
		3	575	2	■	3430	40.36 (1025)	15.24 (387)	25.12 (638)	3.75 (95)	3.98 (101)	41.9
35S30-11	232	1	230	3	●	3431	53.75 (1365)	22.72 (577)	31.03 (788)	3.75 (95)	3.98 (101)	69.9
		3	208	3	●	3440	49.02 (1245)	18.00 (457)	31.03 (788)	3.75 (95)	3.98 (101)	56.7
		3	230	3	●	3440	49.02 (1245)	18.00 (457)	31.03 (788)	3.75 (95)	3.98 (101)	56.7
		3	460	3	●	3468	49.02 (1245)	18.00 (457)	31.03 (788)	3.75 (95)	3.98 (101)	56.7
35S50-15	327	1	230	5	●	3483	65.56 (1665)	26.66 (677)	38.90 (988)	3.75 (95)	3.98 (101)	86.1
		3	208	5	●	3502	61.62 (1565)	22.72 (577)	38.90 (988)	3.75 (95)	3.98 (101)	75.1
		3	230	5	●	3502	61.62 (1565)	22.72 (577)	38.90 (988)	3.75 (95)	3.98 (101)	75.1
		3	460	5	●	3501	61.62 (1565)	22.72 (577)	38.90 (988)	3.75 (95)	3.98 (101)	75.1
35S50-19	407	1	230	5	●	3446	73.43 (1865)	26.66 (677)	46.78 (1188)	3.75 (95)	3.98 (101)	91.2
		3	208	5	●	3473	69.49 (1765)	22.72 (577)	46.78 (1188)	3.75 (95)	3.98 (101)	80.2
		3	230	5	●	3473	69.49 (1765)	22.72 (577)	46.78 (1188)	3.75 (95)	3.98 (101)	80.2
		3	460	5	●	3471	69.49 (1765)	22.72 (577)	46.78 (1188)	3.75 (95)	3.98 (101)	80.2
35S75-22	485	3	208	7.5	●	3495	79.34 (2015)	26.66 (677)	52.68 (1338)	3.75 (95)	3.98 (101)	95.0
		3	230	7.5	●	3495	79.34 (2015)	26.66 (677)	52.68 (1338)	3.75 (95)	3.98 (101)	95.0
		3	460	7.5	●	3495	79.34 (2015)	26.66 (677)	52.68 (1338)	3.75 (95)	3.98 (101)	95.0
		3	575	7.5	●	3495	79.34 (2015)	26.66 (677)	52.68 (1338)	3.75 (95)	3.98 (101)	95.0
35S75-25	547	3	208	7.5	●	3479	85.24 (2165)	26.66 (677)	58.59 (1488)	3.75 (95)	3.98 (101)	98.9
		3	230	7.5	●	3479	85.24 (2165)	26.66 (677)	58.59 (1488)	3.75 (95)	3.98 (101)	98.9
		3	460	7.5	●	3479	85.24 (2165)	26.66 (677)	58.59 (1488)	3.75 (95)	3.98 (101)	98.9
		3	575	7.5	●	3479	85.24 (2165)	26.66 (677)	58.59 (1488)	3.75 (95)	3.98 (101)	98.9
35S75-28	607	3	208	7.5	●	3463	91.15 (2315)	26.66 (677)	64.49 (1638)	3.75 (95)	3.98 (101)	102.7
		3	230	7.5	●	3463	91.15 (2315)	26.66 (677)	64.49 (1638)	3.75 (95)	3.98 (101)	102.7
		3	460	7.5	●	3463	91.15 (2315)	26.66 (677)	64.49 (1638)	3.75 (95)	3.98 (101)	102.7
		3	575	7.5	●	3463	91.15 (2315)	26.66 (677)	64.49 (1638)	3.75 (95)	3.98 (101)	102.7
35S100-31	682	3	460	10	●	3487	100.99 (2565)	30.60 (777)	70.40 (1788)	3.75 (95)	3.98 (101)	115.4
		3	575	10	●	3487	100.99 (2565)	30.60 (777)	70.40 (1788)	3.75 (95)	3.98 (101)	115.4
35S100-34	743	3	460	10	●	3475	106.89 (2715)	30.60 (777)	76.30 (1938)	3.75 (95)	3.98 (101)	119.2
		3	575	10	●	3475	106.89 (2715)	30.60 (777)	76.30 (1938)	3.75 (95)	3.98 (101)	119.2
35S100-38	823	3	460	10	●	3459	114.77 (2915)	30.60 (777)	84.18 (2138)	3.75 (95)	3.98 (101)	124.3
		3	575	10	●	3459	114.77 (2915)	30.60 (777)	84.18 (2138)	3.75 (95)	3.98 (101)	124.3

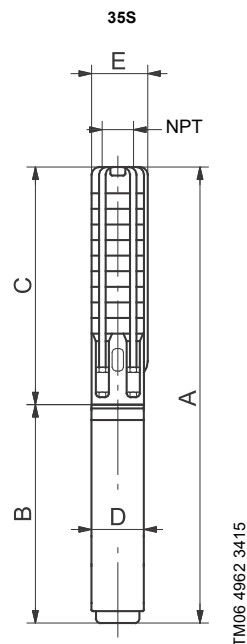

E = Maximum diameter of pump including cable guard and motor.

Notes:

Control box is required for 3-wire, single-phase applications. Data does not include control box. Performance conforms to ISO 9906. 1999 (E) Annex A. Minimum submergence is 5 ft (1.5 m).

- MS 402 motor.
- MS 4000 motor.

4" and larger wells - continued

SP 35S (35 gpm) pump with 6" motor

Pump model	Nom. head [ft]	Motor			Dimensions [in (mm)]					Net weight (complete) [lb]		
		Ph	Volts [V]	[Hp]	[rpm]	A	B	C	D		E	
35S - Motor diameter 6 inch, 60 Hz, rated flow rate 35 gpm (1 1/2" NPT)												
		3	208	5	▲	3480	-	23.51 (597)	-	5.50 (139.5)	-	80.0
		3	230	5	▲	3510	-	23.51 (597)	-	5.50 (139.5)	-	80.0
		3	460	5	▲	3500	-	23.51 (597)	-	5.50 (139.5)	-	80.0
35S75-22	487	3	208	7.5	▲	3502	78.67 (1998)	23.51 (597)	55.16 (1401)	5.50 (140)	5.50 (140)	123.6
	487	3	230	7.5	▲	3502	78.67 (1998)	23.51 (597)	55.16 (1401)	5.50 (140)	5.50 (140)	123.6
	490	3	460	7.5	▲	3510	78.67 (1998)	23.51 (597)	55.16 (1401)	5.50 (140)	5.50 (140)	123.6
35S75-25	489	3	575	7.5	▲	3509	78.67 (1998)	23.51 (597)	55.16 (1401)	5.50 (140)	5.50 (140)	123.6
	549	3	208	7.5	▲	3487	84.57 (2148)	23.51 (597)	61.07 (1551)	5.50 (140)	5.50 (140)	127.5
	549	3	230	7.5	▲	3487	84.57 (2148)	23.51 (597)	61.07 (1551)	5.50 (140)	5.50 (140)	127.5
35S75-28	553	3	460	7.5	▲	3498	84.57 (2148)	23.51 (597)	61.07 (1551)	5.50 (140)	5.50 (140)	127.5
	552	3	575	7.5	▲	3496	84.57 (2148)	23.51 (597)	61.07 (1551)	5.50 (140)	5.50 (140)	127.5
	611	3	208	7.5	▲	3472	90.48 (2298)	23.51 (597)	66.97 (1701)	5.50 (140)	5.50 (140)	131.4
35S100-31	611	3	230	7.5	▲	3472	90.48 (2298)	23.51 (597)	66.97 (1701)	5.50 (140)	5.50 (140)	131.4
	615	3	460	7.5	▲	3484	90.48 (2298)	23.51 (597)	66.97 (1701)	5.50 (140)	5.50 (140)	131.4
	614	3	575	7.5	▲	3483	90.48 (2298)	23.51 (597)	66.97 (1701)	5.50 (140)	5.50 (140)	131.4
35S100-34	688	3	208	10	▲	3489	97.56 (2478)	24.69 (627)	72.88 (1851)	5.50 (140)	5.50 (140)	142.0
	687	3	230	10	▲	3489	97.56 (2478)	24.69 (627)	72.88 (1851)	5.50 (140)	5.50 (140)	142.0
	687	3	460	10	▲	3499	97.56 (2478)	24.69 (627)	72.88 (1851)	5.50 (140)	5.50 (140)	142.0
35S100-38	687	3	575	10	▲	3498	97.56 (2478)	24.69 (627)	72.88 (1851)	5.50 (140)	5.50 (140)	142.0
	744	3	208	10	▲	3476	103.47 (2628)	24.69 (627)	78.78 (2001)	5.50 (140)	5.50 (140)	145.9
	744	3	230	10	▲	3476	103.47 (2628)	24.69 (627)	78.78 (2001)	5.50 (140)	5.50 (140)	145.9
35S100-38	749	3	460	10	▲	3488	103.47 (2628)	24.69 (627)	78.78 (2001)	5.50 (140)	5.50 (140)	145.9
	749	3	575	10	▲	3488	103.47 (2628)	24.69 (627)	78.78 (2001)	5.50 (140)	5.50 (140)	145.9
	824	3	208	10	▲	3459	111.34 (2828)	24.69 (627)	86.66 (2201)	5.50 (140)	5.50 (140)	151.1
35S100-38	824	3	230	10	▲	3459	111.34 (2828)	24.69 (627)	86.66 (2201)	5.50 (140)	5.50 (140)	151.1
	830	3	460	10	▲	3474	111.34 (2828)	24.69 (627)	86.66 (2201)	5.50 (140)	5.50 (140)	151.1
	830	3	575	10	▲	3473	111.34 (2828)	24.69 (627)	86.66 (2201)	5.50 (140)	5.50 (140)	151.1

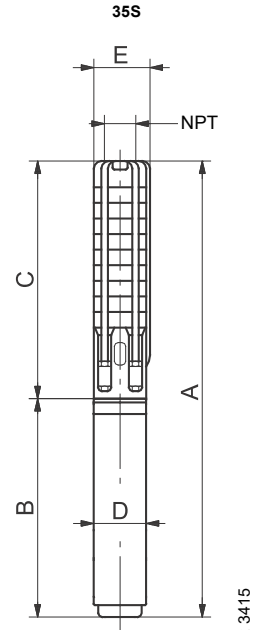

TM06 4962 3415

E = Maximum diameter of pump including cable guard and motor.

Notes: Performance conforms to ISO 9906: 1999 (E) Annex A. Minimum submergence is 5 ft (1.5 m).

▲ MS 6000C motor.

4" and larger wells - continued

SP 35S (35 gpm) pump with 6" motor

Pump model	Nom. head [ft]	Motor				Dimensions [in (mm)]					Net weight (complete) [lb]
		Ph	Volts [V]	[Hp]	[rpm]	A	B	C	D	E	
35S - Motor diameter 6 inch, 60 Hz, rated flow rate 35 gpm (2" NPT)											
35S150-41DS	912	3	208	15	▲ 3503	131.23 (3333)	27.05 (687)	104.18 (2646)	5.50 (140)	5.50 (140)	217.3
	912	3	230	15	▲ 3503	131.23 (3333)	27.05 (687)	104.18 (2646)	5.50 (140)	5.50 (140)	217.3
	914	3	460	15	▲ 3507	131.23 (3333)	27.05 (687)	104.18 (2646)	5.50 (140)	5.50 (140)	217.3
	913	3	575	15	▲ 3506	131.23 (3333)	27.05 (687)	104.18 (2646)	5.50 (140)	5.50 (140)	217.3
35S150-44DS	975	3	208	15	▲ 3496	137.13 (3483)	27.05 (687)	110.08 (2796)	5.50 (140)	5.50 (140)	223.1
	975	3	230	15	▲ 3496	137.13 (3483)	27.05 (687)	110.08 (2796)	5.50 (140)	5.50 (140)	223.1
	977	3	460	15	▲ 3500	137.13 (3483)	27.05 (687)	110.08 (2796)	5.50 (140)	5.50 (140)	223.1
	976	3	575	15	▲ 3499	137.13 (3483)	27.05 (687)	110.08 (2796)	5.50 (140)	5.50 (140)	223.1
35S150-47DS	1037	3	208	15	▲ 3488	143.04 (3633)	27.05 (687)	115.99 (2946)	5.50 (140)	5.50 (140)	228.8
	1037	3	230	15	▲ 3488	143.04 (3633)	27.05 (687)	115.99 (2946)	5.50 (140)	5.50 (140)	228.8
	1040	3	460	15	▲ 3493	143.04 (3633)	27.05 (687)	115.99 (2946)	5.50 (140)	5.50 (140)	228.8
	1039	3	575	15	▲ 3491	143.04 (3633)	27.05 (687)	115.99 (2946)	5.50 (140)	5.50 (140)	228.8
35S150-50DS	1098	3	208	15	▲ 3480	148.94 (3783)	27.05 (687)	121.89 (3096)	5.50 (140)	5.50 (140)	234.6
	1098	3	230	15	▲ 3480	148.94 (3783)	27.05 (687)	121.89 (3096)	5.50 (140)	5.50 (140)	234.6
	1101	3	460	15	▲ 3485	148.94 (3783)	27.05 (687)	121.89 (3096)	5.50 (140)	5.50 (140)	234.6
	1100	3	575	15	▲ 3484	148.94 (3783)	27.05 (687)	121.89 (3096)	5.50 (140)	5.50 (140)	234.6
35S150-53DS	1159	3	208	15	▲ 3472	154.85 (3933)	27.05 (687)	127.80 (3246)	5.50 (140)	5.50 (140)	240.3
	1159	3	230	15	▲ 3472	154.85 (3933)	27.05 (687)	127.80 (3246)	5.50 (140)	5.50 (140)	240.3
	1163	3	460	15	▲ 3478	154.85 (3933)	27.05 (687)	127.80 (3246)	5.50 (140)	5.50 (140)	240.3
	1161	3	575	15	▲ 3476	154.85 (3933)	27.05 (687)	127.80 (3246)	5.50 (140)	5.50 (140)	240.3
35S150-56DS	1218	3	208	15	▲ 3464	160.75 (4083)	27.05 (687)	133.71 (3396)	5.50 (140)	5.50 (140)	246.1
	1218	3	230	15	▲ 3464	160.75 (4083)	27.05 (687)	133.71 (3396)	5.50 (140)	5.50 (140)	246.1
	1223	3	460	15	▲ 3470	160.75 (4083)	27.05 (687)	133.71 (3396)	5.50 (140)	5.50 (140)	246.1
	1222	3	575	15	▲ 3468	160.75 (4083)	27.05 (687)	133.71 (3396)	5.50 (140)	5.50 (140)	246.1
35S200-60DS	1329	3	208	20	▲ 3494	171.19 (4348)	29.61 (752)	141.58 (3596)	5.50 (140)	5.50 (140)	269.2
	1329	3	230	20	▲ 3494	171.19 (4348)	29.61 (752)	141.58 (3596)	5.50 (140)	5.50 (140)	269.2
	1337	3	460	20	▲ 3503	171.19 (4348)	29.61 (752)	141.58 (3596)	5.50 (140)	5.50 (140)	269.2
	1338	3	575	20	▲ 3506	171.19 (4348)	29.61 (752)	141.58 (3596)	5.50 (140)	5.50 (140)	269.2
35S200-64DS	1412	3	208	20	▲ 3486	179.06 (4548)	29.61 (752)	149.45 (3796)	5.50 (140)	5.50 (140)	276.9
	1412	3	230	20	▲ 3486	179.06 (4548)	29.61 (752)	149.45 (3796)	5.50 (140)	5.50 (140)	276.9
	1420	3	460	20	▲ 3497	179.06 (4548)	29.61 (752)	149.45 (3796)	5.50 (140)	5.50 (140)	276.9
	1422	3	575	20	▲ 3499	179.06 (4548)	29.61 (752)	149.45 (3796)	5.50 (140)	5.50 (140)	276.9
35S200-67DS	1473	3	208	20	▲ 3491	184.97 (4698)	29.61 (752)	155.36 (3946)	5.50 (140)	5.50 (140)	282.7
	1473	3	230	20	▲ 3491	184.97 (4698)	29.61 (752)	155.36 (3946)	5.50 (140)	5.50 (140)	282.7
	1482	3	460	20	▲ 3480	184.97 (4698)	29.61 (752)	155.36 (3946)	5.50 (140)	5.50 (140)	282.7
	1485	3	575	20	▲ 3494	184.97 (4698)	29.61 (752)	155.36 (3946)	5.50 (140)	5.50 (140)	282.7

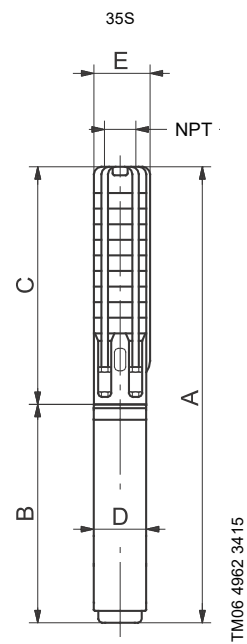

E = Maximum diameter of pump including cable guard and motor.

Notes:
 DS designation = Built into sleeve, 2" NPT, 6" minimum well diameter.
 Performance conforms to ISO 9906, 1999 (E) Annex A. Minimum submergence is 5 ft (1.5 m).
 ▲ MS 6000C motor.

4" and larger wells - continued

SP 45S (45 gpm)

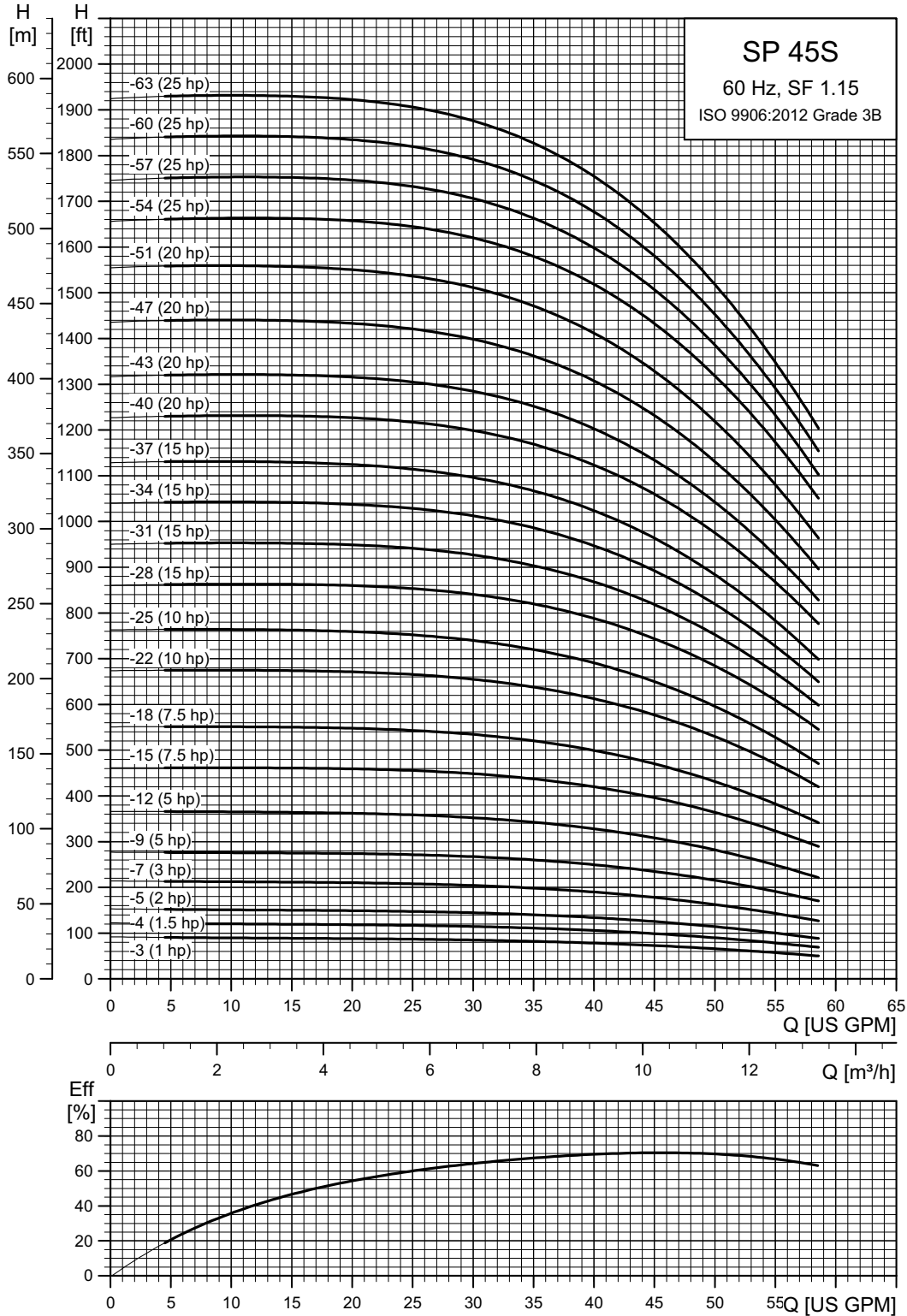

TM06 4616 3215

4" and larger wells - continued

SP 45S (45 gpm) pump power requirement (P2)

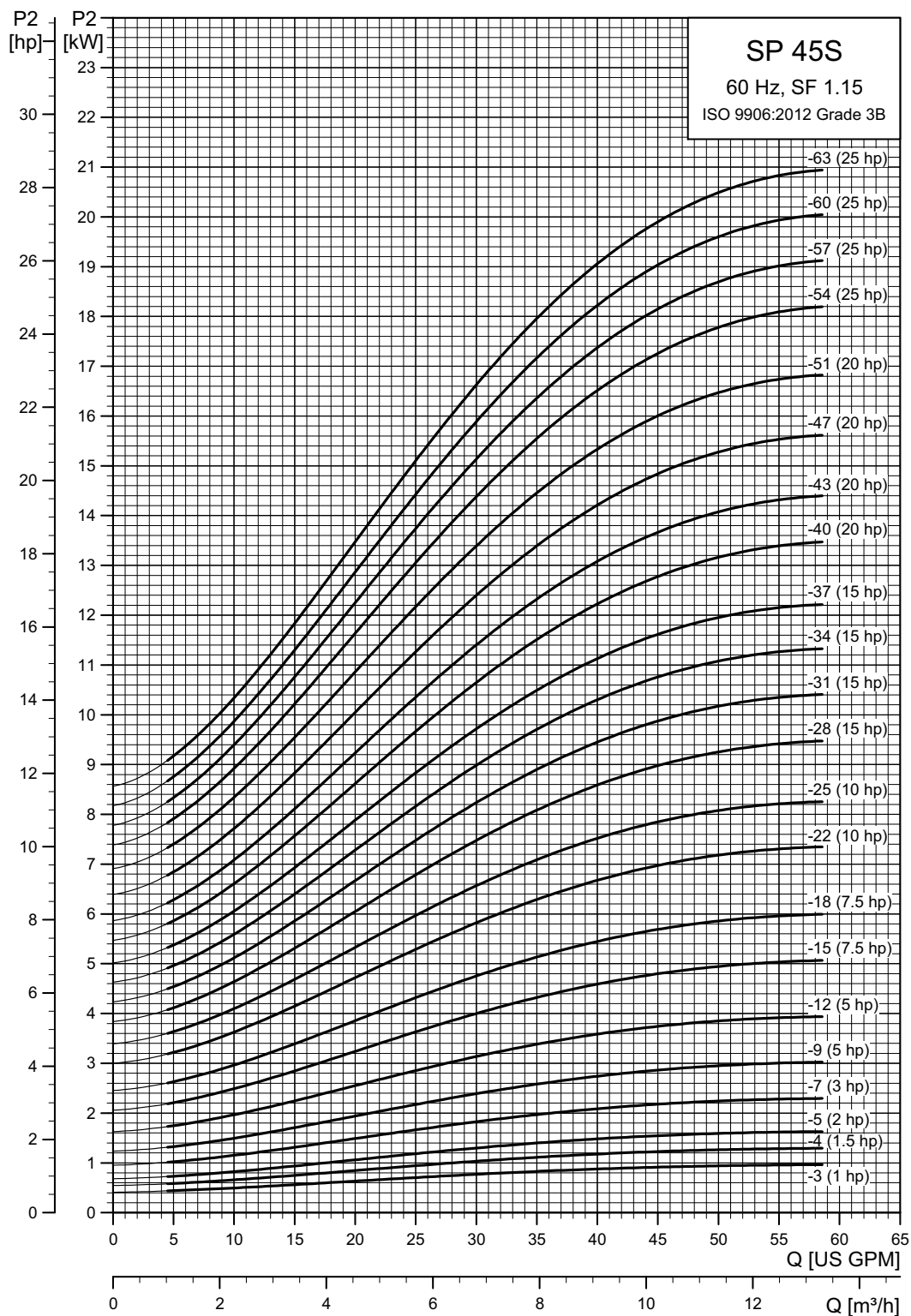

TM06 4617 3215

4" and larger wells - continued

SP 45S (45 gpm) pump with 4" motor

Pump model	Nom. head [ft]	Motor				Dimensions [in (mm)]					Net weight (complete) [lb]	
		Ph	Volts [V]	[Hp]	[rpm]	A	B	C	D	E		
45S - Motor diameter 4-inch, 3-wire motor, 60 Hz, rated flow rate 45 gpm (2" NPT)												
45S10-3	72	1	230	1	■	3416	28.94 (735)	13.67 (347)	15.28 (388)	3.75 (95)	3.98 (101)	31.5
	73	3	230	1	■	3435	27.76 (705)	12.49 (317)	15.28 (388)	3.75 (95)	3.98 (101)	28.8
	73	3	460	1	■	3435	27.76 (705)	12.49 (317)	15.28 (388)	3.75 (95)	3.98 (101)	28.6
45S15-4	72	3	575	1	■	3422	27.76 (705)	12.49 (317)	15.28 (388)	3.75 (95)	3.98 (101)	28.6
	98	1	230	1.5	■	3451	32.49 (825)	15.24 (387)	17.25 (438)	3.75 (95)	3.98 (101)	36.5
	99	3	230	1.5	■	3458	30.91 (785)	13.67 (347)	17.25 (438)	3.75 (95)	3.98 (101)	33.0
45S20-5	99	3	460	1.5	■	3458	30.91 (785)	13.67 (347)	17.25 (438)	3.75 (95)	3.98 (101)	33.0
	97	3	575	1.5	■	3435	30.91 (785)	13.67 (347)	17.25 (438)	3.75 (95)	3.98 (101)	32.8
	124	1	230	2	●	3454	38.78 (985)	19.57 (497)	19.22 (488)	3.75 (95)	3.98 (101)	53.4
45S30-7	124	3	230	2	■	3451	34.45 (875)	15.24 (387)	19.22 (488)	3.75 (95)	3.98 (101)	38.0
	124	3	460	2	■	3451	34.45 (875)	15.24 (387)	19.22 (488)	3.75 (95)	3.98 (101)	38.2
	123	3	575	2	■	3446	34.45 (875)	15.24 (387)	19.22 (488)	3.75 (95)	3.98 (101)	38.0
45S30-7	174	1	230	3	●	3448	45.87 (1165)	22.72 (577)	23.15 (588)	3.75 (95)	3.98 (101)	64.8
	174	3	208	3	●	3452	41.15 (1045)	18.00 (457)	23.15 (588)	3.75 (95)	3.98 (101)	51.6
	174	3	230	3	●	3452	41.15 (1045)	18.00 (457)	23.15 (588)	3.75 (95)	3.98 (101)	51.6
45S50-9	178	3	460	3	●	3481	41.15 (1045)	18.00 (457)	23.15 (588)	3.75 (95)	3.98 (101)	51.6
	185	3	575	3	●	3530	41.15 (1045)	18.00 (457)	23.15 (588)	3.75 (95)	3.98 (101)	51.4
	232	1	230	5	●	3502	53.75 (1365)	26.66 (677)	27.09 (688)	3.75 (95)	3.98 (101)	78.4
45S50-9	234	3	208	5	●	3517	49.81 (1265)	22.72 (577)	27.09 (688)	3.75 (95)	3.98 (101)	67.4
	234	3	230	5	●	3517	49.81 (1265)	22.72 (577)	27.09 (688)	3.75 (95)	3.98 (101)	67.4
	234	3	460	5	●	3516	49.81 (1265)	22.72 (577)	27.09 (688)	3.75 (95)	3.98 (101)	67.4
45S50-12	237	3	575	5	●	3515	49.81 (1265)	22.72 (577)	27.09 (688)	3.75 (95)	3.98 (101)	67.2
	301	1	230	5	●	3462	59.65 (1515)	26.66 (677)	33.00 (838)	3.75 (95)	3.98 (101)	82.2
	306	3	208	5	●	3486	55.71 (1415)	22.72 (577)	33.00 (838)	3.75 (95)	3.98 (101)	71.2
45S75-15	306	3	230	5	●	3486	55.71 (1415)	22.72 (577)	33.00 (838)	3.75 (95)	3.98 (101)	71.2
	306	3	460	5	●	3483	55.71 (1415)	22.72 (577)	33.00 (838)	3.75 (95)	3.98 (101)	71.2
	308	3	575	5	●	3485	55.71 (1415)	22.72 (577)	33.00 (838)	3.75 (95)	3.98 (101)	71.0
45S75-15	386	3	208	7.5	●	3497	65.56 (1665)	26.66 (677)	38.90 (988)	3.75 (95)	3.98 (101)	86.1
	386	3	230	7.5	●	3497	65.56 (1665)	26.66 (677)	38.90 (988)	3.75 (95)	3.98 (101)	86.1
	386	3	460	7.5	●	3497	65.56 (1665)	26.66 (677)	38.90 (988)	3.75 (95)	3.98 (101)	86.1
45S75-18	386	3	575	7.5	●	3497	65.56 (1665)	26.66 (677)	38.90 (988)	3.75 (95)	3.98 (101)	86.1
	458	3	208	7.5	●	3474	71.46 (1815)	26.66 (677)	44.81 (1138)	3.75 (95)	3.98 (101)	89.9
	458	3	230	7.5	●	3474	71.46 (1815)	26.66 (677)	44.81 (1138)	3.75 (95)	3.98 (101)	89.9
45S100-22	458	3	460	7.5	●	3474	71.46 (1815)	26.66 (677)	44.81 (1138)	3.75 (95)	3.98 (101)	89.9
	458	3	575	7.5	●	3474	71.46 (1815)	26.66 (677)	44.81 (1138)	3.75 (95)	3.98 (101)	89.9
	564	3	460	10	●	3484	83.27 (2115)	30.60 (777)	52.68 (1338)	3.75 (95)	3.98 (101)	103.8
45S100-25	564	3	575	10	●	3484	83.27 (2115)	30.60 (777)	52.68 (1338)	3.75 (95)	3.98 (101)	103.8
	632	3	460	10	●	3466	89.18 (2265)	30.60 (777)	58.59 (1488)	3.75 (95)	3.98 (101)	107.7
45S100-25	632	3	575	10	●	3466	89.18 (2265)	30.60 (777)	58.59 (1488)	3.75 (95)	3.98 (101)	107.7

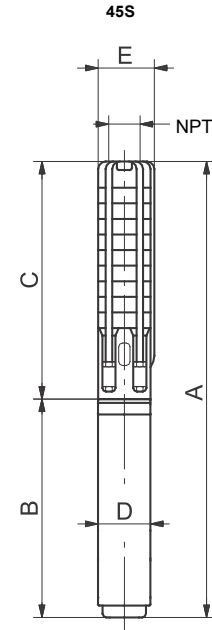

E = Maximum diameter of pump including cable guard and motor.

TM06 4962 3415

Notes:

Control box is required for 3-wire, single-phase applications. Data does not include control box. Performance conforms to ISO 9906: 1999 (E) Annex A. Minimum submergence is 5 ft (1.5 m).

- MS 402 motor.
- MS 4000 motor.

4" and larger wells - continued

SP 45S (45 gpm) pump with 6" motor

Pump model	Nom. head [ft]	Motor			Dimensions [in (mm)]					Net weight (complete) [lb]				
		Ph	Volts [V]	[Hp]	[rpm]	A	B	C	D		E			
45S - Motor diameter 6 inch, 60 Hz, rated flow rate 45 gpm (2" NPT)														
-	-	3	208	5	▲	3480	-	23.51 (597)	-	5.50 (139.5)	-	80.0		
			230	5	▲	3510	-	23.51 (597)	-	5.50 (139.5)	-	80.0		
			460	5	▲	3500	-	23.51 (597)	-	5.50 (139.5)	-	80.0		
45S75-15	3	3	208	7.5	▲	3504	64.89 (1648)	23.51 (597)	41.38 (1051)	5.50 (140)	5.50 (140)	114.4		
			230	7.5	▲	3504	64.89 (1648)	23.51 (597)	41.38 (1051)	5.50 (140)	5.50 (140)	114.4		
			460	7.5	▲	3512	64.89 (1648)	23.51 (597)	41.38 (1051)	5.50 (140)	5.50 (140)	114.4		
45S75-18	3	3	208	7.5	▲	3482	70.79 (1798)	23.51 (597)	47.29 (1201)	5.50 (140)	5.50 (140)	118.3		
			230	7.5	▲	3482	70.79 (1798)	23.51 (597)	47.29 (1201)	5.50 (140)	5.50 (140)	118.3		
			460	7.5	▲	3493	70.79 (1798)	23.51 (597)	47.29 (1201)	5.50 (140)	5.50 (140)	118.3		
45S100-22	3	3	208	10	▲	3485	79.85 (2028)	24.69 (627)	55.16 (1401)	5.50 (140)	5.50 (140)	130.2		
			230	10	▲	3485	79.85 (2028)	24.69 (627)	55.16 (1401)	5.50 (140)	5.50 (140)	130.2		
			460	10	▲	3496	79.85 (2028)	24.69 (627)	55.16 (1401)	5.50 (140)	5.50 (140)	130.2		
45S100-25	3	3	208	10	▲	3467	85.75 (2178)	24.69 (627)	61.07 (1551)	5.50 (140)	5.50 (140)	134.1		
			230	10	▲	3467	85.75 (2178)	24.69 (627)	61.07 (1551)	5.50 (140)	5.50 (140)	134.1		
			460	10	▲	3481	85.75 (2178)	24.69 (627)	61.07 (1551)	5.50 (140)	5.50 (140)	134.1		
45S150-28	3	3	208	15	▲	3505	94.02 (2388)	27.05 (687)	66.97 (1701)	5.50 (140)	5.50 (140)	160.6		
			230	15	▲	3505	94.02 (2388)	27.05 (687)	66.97 (1701)	5.50 (140)	5.50 (140)	160.6		
			460	15	▲	3508	94.02 (2388)	27.05 (687)	66.97 (1701)	5.50 (140)	5.50 (140)	160.6		
45S150-31	3	3	208	15	▲	3494	99.93 (2538)	27.05 (687)	72.88 (1851)	5.50 (140)	5.50 (140)	164.7		
			230	15	▲	3494	99.93 (2538)	27.05 (687)	72.88 (1851)	5.50 (140)	5.50 (140)	164.7		
			460	15	▲	3498	99.93 (2538)	27.05 (687)	72.88 (1851)	5.50 (140)	5.50 (140)	164.7		
45S150-34	3	3	208	15	▲	3482	105.83 (2688)	27.05 (687)	78.78 (2001)	5.50 (140)	5.50 (140)	168.8		
			230	15	▲	3482	105.83 (2688)	27.05 (687)	78.78 (2001)	5.50 (140)	5.50 (140)	168.8		
			460	15	▲	3487	105.83 (2688)	27.05 (687)	78.78 (2001)	5.50 (140)	5.50 (140)	168.8		
45S150-37	3	3	208	15	▲	3470	111.74 (2838)	27.05 (687)	84.69 (2151)	5.50 (140)	5.50 (140)	172.9		
			230	15	▲	3470	111.74 (2838)	27.05 (687)	84.69 (2151)	5.50 (140)	5.50 (140)	172.9		
			460	15	▲	3476	111.74 (2838)	27.05 (687)	84.69 (2151)	5.50 (140)	5.50 (140)	172.9		
45S200-40DS	3	3	208	20	▲	3498	131.82 (3348)	29.61 (752)	102.21 (2596)	5.50 (140)	5.50 (140)	230.8		
			230	20	▲	3498	131.82 (3348)	29.61 (752)	102.21 (2596)	5.50 (140)	5.50 (140)	230.8		
			460	20	▲	3507	131.82 (3348)	29.61 (752)	102.21 (2596)	5.50 (140)	5.50 (140)	230.8		
45S200-43DS	3	3	208	20	▲	3489	137.72 (3498)	29.61 (752)	108.12 (2746)	5.50 (140)	5.50 (140)	236.6		
			230	20	▲	3489	137.72 (3498)	29.61 (752)	108.12 (2746)	5.50 (140)	5.50 (140)	236.6		
			460	20	▲	3500	137.72 (3498)	29.61 (752)	108.12 (2746)	5.50 (140)	5.50 (140)	236.6		
45S200-47DS	3	3	208	20	▲	3478	145.60 (3698)	29.61 (752)	115.99 (2946)	5.50 (140)	5.50 (140)	244.2		
			230	20	▲	3489	145.60 (3698)	29.61 (752)	115.99 (2946)	5.50 (140)	5.50 (140)	244.2		
			460	20	▲	3489	145.60 (3698)	29.61 (752)	115.99 (2946)	5.50 (140)	5.50 (140)	244.2		
45S200-51DS	3	3	208	20	▲	3466	153.47 (3898)	29.61 (752)	123.86 (3146)	5.50 (140)	5.50 (140)	251.9		
			230	20	▲	3466	153.47 (3898)	29.61 (752)	123.86 (3146)	5.50 (140)	5.50 (140)	251.9		
			460	20	▲	3479	153.47 (3898)	29.61 (752)	123.86 (3146)	5.50 (140)	5.50 (140)	251.9		
			1302	3	575	20	▲	3482	153.47 (3898)	29.61 (752)	123.86 (3146)	5.50 (140)	5.50 (140)	251.9

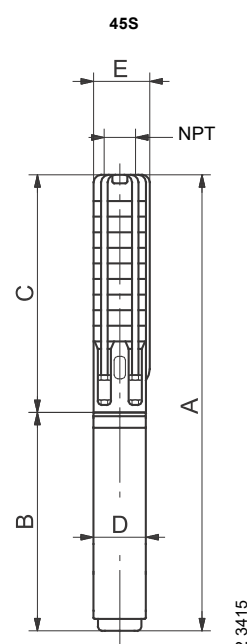

TM06 4962 3415

E = Maximum diameter of pump including cable guard and motor.

Notes: DS designation = Built into sleeve, 2" NPT, 6" minimum well diameter.
 Performance conforms to ISO 9906. 1999 (E) Annex A. Minimum submergence is 5 ft (1.5 m).
 ▲ MS 6000C motor.

4" and larger wells - continued

SP 45S (45 gpm) pump with 6" motor

Pump model	Nom. head [ft]	Motor				Dimensions [in (mm)]					Net weight (complete) [lb]	
		Ph	Volts [V]	[Hp]	[rpm]	A	B	C	D	E		
45S - Motor diameter 6 inch, 60 Hz, rated flow rate 45 gpm (2" NPT)												
45S250-54DS	1389	3	208	25	▲	3490	161.54 (4103)	31.78 (807)	129.77 (3296)	5.50 (140)	5.50 (140)	267.6
	1389	3	230	25	▲	3490	161.54 (4103)	31.78 (807)	129.77 (3296)	5.50 (140)	5.50 (140)	267.6
	1404	3	460	25	▲	3501	161.54 (4103)	31.78 (807)	129.77 (3296)	5.50 (140)	5.50 (140)	267.6
	1405	3	575	25	▲	3501	161.54 (4103)	31.78 (807)	129.77 (3296)	5.50 (140)	5.50 (140)	267.6
45S250-57DS	1460	3	208	25	▲	3484	167.45 (4253)	31.78 (807)	135.67 (3446)	5.50 (140)	5.50 (140)	273.4
	1460	3	230	25	▲	3484	167.45 (4253)	31.78 (807)	135.67 (3446)	5.50 (140)	5.50 (140)	273.4
	1471	3	460	25	▲	3494	167.45 (4253)	31.78 (807)	135.67 (3446)	5.50 (140)	5.50 (140)	273.4
	1471	3	575	25	▲	3495	167.45 (4253)	31.78 (807)	135.67 (3446)	5.50 (140)	5.50 (140)	273.4
45S250-60DS	1530	3	208	25	▲	3477	173.35 (4403)	31.78 (807)	141.58 (3596)	5.50 (140)	5.50 (140)	279.1
	1530	3	230	25	▲	3477	173.35 (4403)	31.78 (807)	141.58 (3596)	5.50 (140)	5.50 (140)	279.1
	1542	3	460	25	▲	3488	173.35 (4403)	31.78 (807)	141.58 (3596)	5.50 (140)	5.50 (140)	279.1
	1543	3	575	25	▲	3489	173.35 (4403)	31.78 (807)	141.58 (3596)	5.50 (140)	5.50 (140)	279.1
45S250-63DS	1599	3	208	25	▲	3470	167.64 (4258)	31.78 (807)	135.87 (3451)	5.50 (140)	5.50 (140)	233.7
	1599	3	230	25	▲	3470	167.64 (4258)	31.78 (807)	135.87 (3451)	5.50 (140)	5.50 (140)	233.7
	1612	3	460	25	▲	3482	167.64 (4258)	31.78 (807)	135.87 (3451)	5.50 (140)	5.50 (140)	233.7
	1613	3	575	25	▲	3483	167.64 (4258)	31.78 (807)	135.87 (3451)	5.50 (140)	5.50 (140)	233.7

Notes:

DS designation = Built into sleeve, 2" NPT, 6" minimum well diameter.

Performance conforms to ISO 9906. 1999 (E) Annex A. Minimum submergence is 5 ft (1.5 m).

▲ MS 6000C motor.

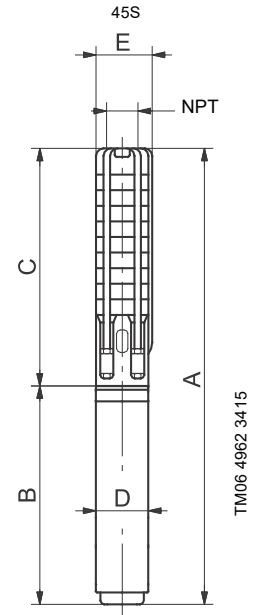

E = Maximum diameter of pump including cable guard and motor.

4" and larger wells - continued

SP 62S (62 gpm)

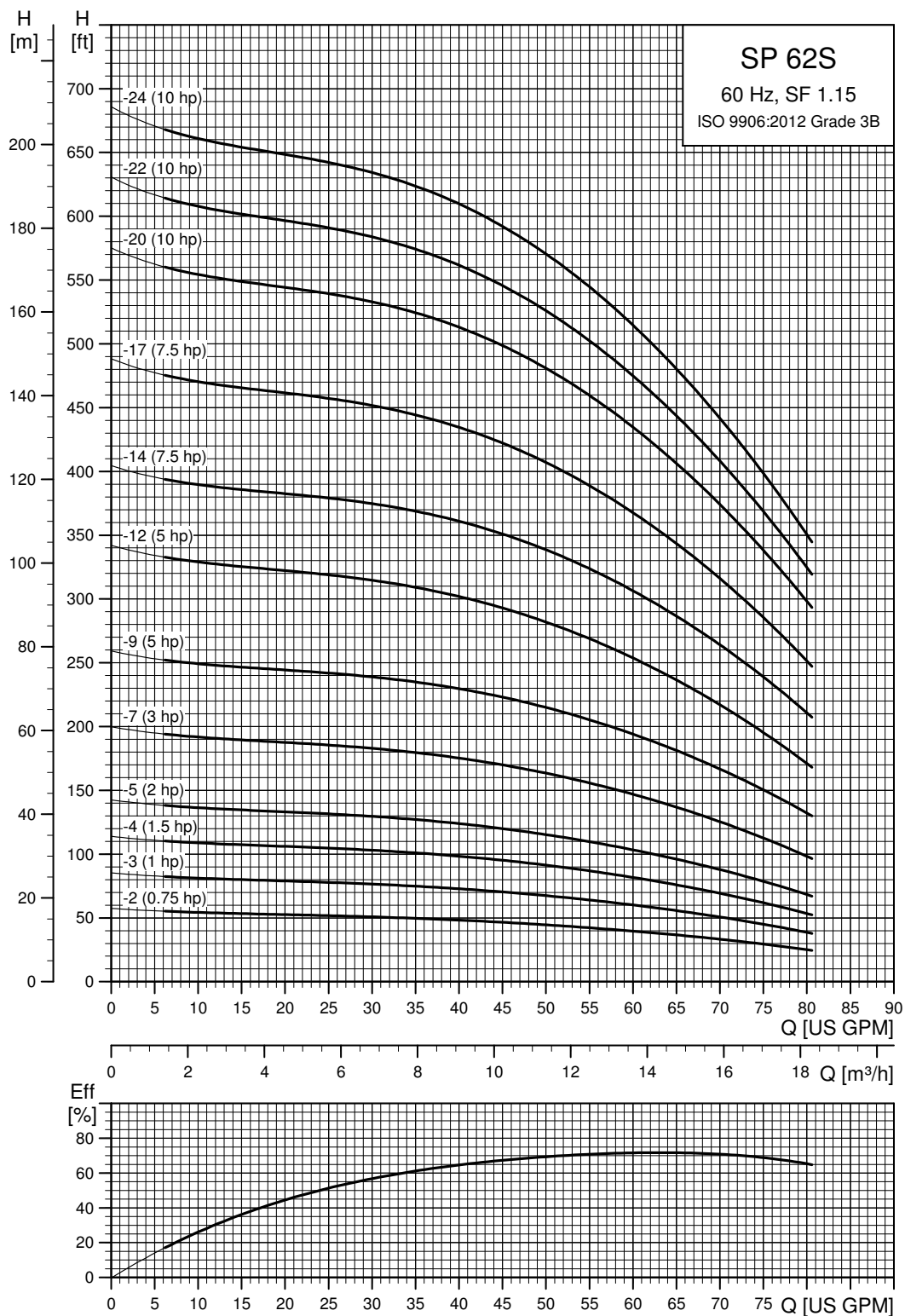

TM06 4618 3215

4" and larger wells - continued

SP 62S (62 gpm) pump power requirement (P2)

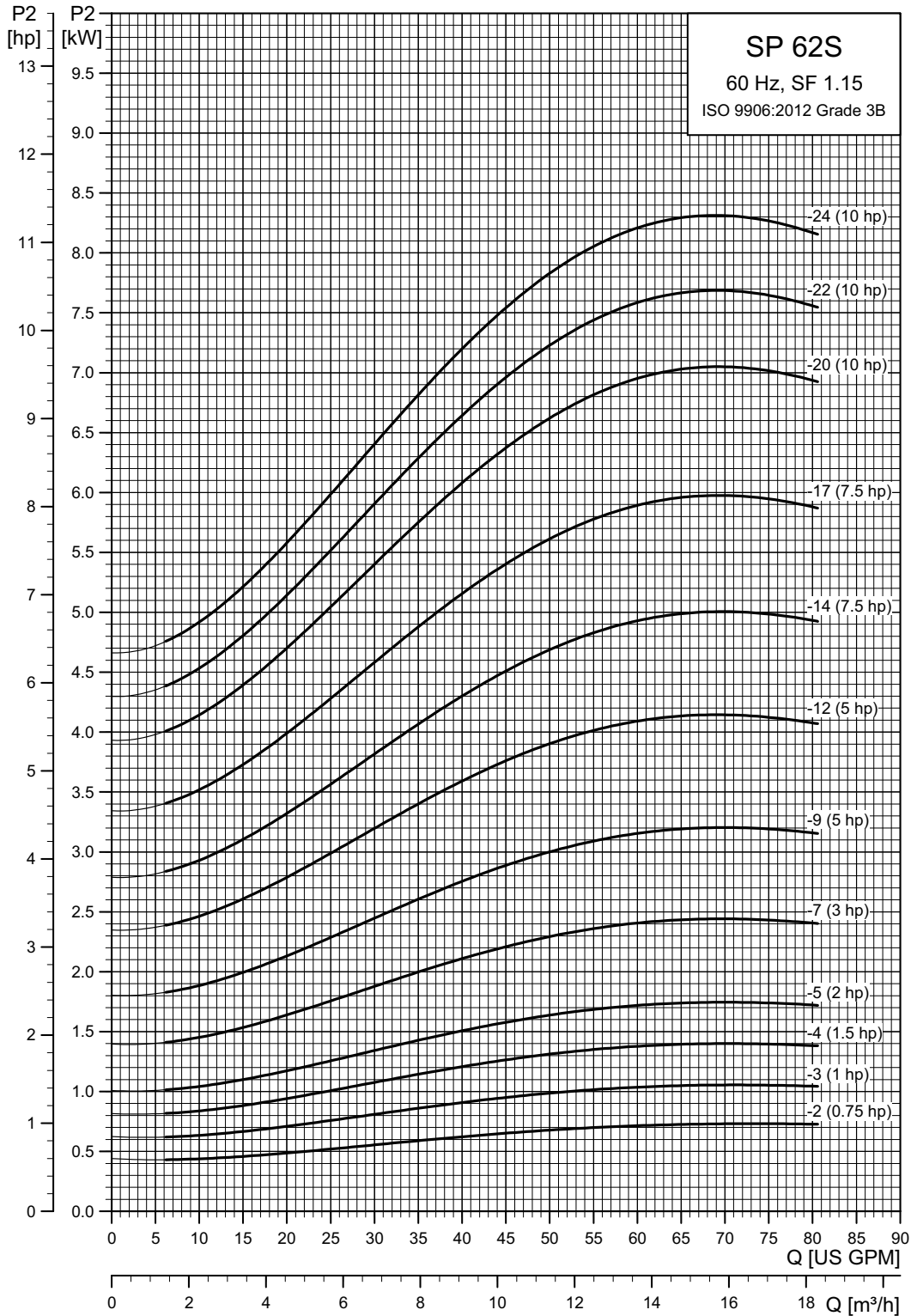

TM06 4619 3215

4" and larger wells - continued

SP 62S (62 gpm) pump with 4" motor

Pump model	Nom. head [ft]	Motor				Dimensions [in (mm)]					Net weight (complete) [lb]	
		Ph	Volts [V]	[Hp]	[rpm]	A	B	C	D	E		
62S - Motor diameter 4-inch, 3-wire motor, 60 Hz, rated flow rate 62 gpm (2" NPT)												
62S07-2	40	1	230	.75	■	3407	28.35 (720)	13.08 (332)	15.28 (388)	3.75 (95)	3.98 (101)	29.7
	40	3	230	.75	■	3423	26.97 (685)	11.70 (297)	15.28 (388)	3.75 (95)	3.98 (101)	26.7
	40	3	460	.75	■	3423	26.97 (685)	11.70 (297)	15.28 (388)	3.75 (95)	3.98 (101)	26.7
62S10-3	40	3	575	.75	■	3414	26.97 (685)	11.70 (297)	15.28 (388)	3.75 (95)	3.98 (101)	26.7
	57	1	230	1	■	3381	31.89 (810)	13.67 (347)	18.23 (463)	3.75 (95)	3.98 (101)	33.0
	58	3	230	1	■	3407	30.71 (780)	12.49 (317)	18.23 (463)	3.75 (95)	3.98 (101)	30.4
62S15-4	58	3	460	1	■	3407	30.71 (780)	12.49 (317)	18.23 (463)	3.75 (95)	3.98 (101)	30.2
	57	3	575	1	■	3398	30.71 (780)	12.49 (317)	18.23 (463)	3.75 (95)	3.98 (101)	30.2
	78	1	230	1.5	■	3427	36.42 (925)	15.24 (387)	21.19 (538)	3.75 (95)	3.98 (101)	38.5
62S20-5	79	3	230	1.5	■	3439	34.85 (885)	13.67 (347)	21.19 (538)	3.75 (95)	3.98 (101)	35.0
	79	3	460	1.5	■	3439	34.85 (885)	13.67 (347)	21.19 (538)	3.75 (95)	3.98 (101)	35.0
	78	3	575	1.5	■	3415	34.85 (885)	13.67 (347)	21.19 (538)	3.75 (95)	3.98 (101)	34.8
62S30-7	98	1	230	2	●	3433	43.71 (1110)	19.57 (497)	24.14 (613)	3.75 (95)	3.98 (101)	56.0
	98	3	230	2	■	3431	39.38 (1000)	15.24 (387)	24.14 (613)	3.75 (95)	3.98 (101)	40.5
	98	3	460	2	■	3431	39.38 (1000)	15.24 (387)	24.14 (613)	3.75 (95)	3.98 (101)	40.7
62S50-9	98	3	575	2	■	3430	39.38 (1000)	15.24 (387)	24.14 (613)	3.75 (95)	3.98 (101)	40.5
	136	1	230	3	●	3427	52.76 (1340)	22.72 (577)	30.04 (763)	3.75 (95)	3.98 (101)	68.3
	138	3	208	3	●	3437	48.04 (1220)	18.00 (457)	30.04 (763)	3.75 (95)	3.98 (101)	55.1
62S75-14	138	3	230	3	●	3437	48.04 (1220)	18.00 (457)	30.04 (763)	3.75 (95)	3.98 (101)	55.1
	141	3	460	3	●	3466	48.04 (1220)	18.00 (457)	30.04 (763)	3.75 (95)	3.98 (101)	55.1
	141	3	575	3	●	3470	48.04 (1220)	18.00 (457)	30.04 (763)	3.75 (95)	3.98 (101)	54.9
62S100-20	184	1	230	5	●	3490	62.60 (1590)	26.66 (677)	35.95 (913)	3.75 (95)	3.98 (101)	82.8
	186	3	208	5	●	3507	58.67 (1490)	22.72 (577)	35.95 (913)	3.75 (95)	3.98 (101)	71.8
	186	3	230	5	●	3507	58.67 (1490)	22.72 (577)	35.95 (913)	3.75 (95)	3.98 (101)	71.8
62S100-22	186	3	460	5	●	3506	58.67 (1490)	22.72 (577)	35.95 (913)	3.75 (95)	3.98 (101)	71.8
	182	3	575	5	●	3470	58.67 (1490)	22.72 (577)	35.95 (913)	3.75 (95)	3.98 (101)	71.6
	237	1	230	5	●	3446	71.46 (1815)	26.66 (677)	44.81 (1138)	3.75 (95)	3.98 (101)	88.1
62S150-12	242	3	208	5	●	3473	67.52 (1715)	22.72 (577)	44.81 (1138)	3.75 (95)	3.98 (101)	77.1
	242	3	230	5	●	3473	67.52 (1715)	22.72 (577)	44.81 (1138)	3.75 (95)	3.98 (101)	77.1
	242	3	460	5	●	3471	67.52 (1715)	22.72 (577)	44.81 (1138)	3.75 (95)	3.98 (101)	77.1
62S200-24	244	3	575	5	●	3470	67.52 (1715)	22.72 (577)	44.81 (1138)	3.75 (95)	3.98 (101)	76.9
	287	3	208	7.5	●	3494	77.37 (1965)	26.66 (677)	50.71 (1288)	3.75 (95)	3.98 (101)	91.6
	287	3	230	7.5	●	3494	77.37 (1965)	26.66 (677)	50.71 (1288)	3.75 (95)	3.98 (101)	91.6
62S250-17	287	3	460	7.5	●	3494	77.37 (1965)	26.66 (677)	50.71 (1288)	3.75 (95)	3.98 (101)	91.6
	342	3	208	7.5	●	3469	86.23 (2190)	26.66 (677)	59.57 (1513)	3.75 (95)	3.98 (101)	96.9
	342	3	230	7.5	●	3469	86.23 (2190)	26.66 (677)	59.57 (1513)	3.75 (95)	3.98 (101)	96.9
62S300-20	342	3	460	7.5	●	3469	86.23 (2190)	26.66 (677)	59.57 (1513)	3.75 (95)	3.98 (101)	96.9
	407	3	460	10	●	3485	99.02 (2515)	30.60 (777)	68.43 (1738)	3.75 (95)	3.98 (101)	111.0
	407	3	575	10	●	3485	99.02 (2515)	30.60 (777)	68.43 (1738)	3.75 (95)	3.98 (101)	111.0
62S400-22	445	3	460	10	●	3472	104.93 (2665)	30.60 (777)	74.34 (1888)	3.75 (95)	3.98 (101)	114.5
	445	3	575	10	●	3472	104.93 (2665)	30.60 (777)	74.34 (1888)	3.75 (95)	3.98 (101)	114.5
62S500-24	478	3	460	10	●	3460	110.83 (2815)	30.60 (777)	80.24 (2038)	3.75 (95)	3.98 (101)	118.0
	478	3	575	10	●	3460	110.83 (2815)	30.60 (777)	80.24 (2038)	3.75 (95)	3.98 (101)	118.0

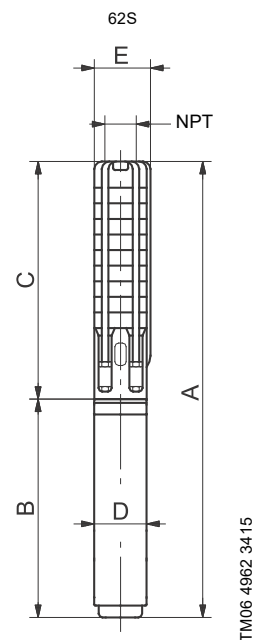

TM06 4962 3415

E = Maximum diameter of pump including cable guard and motor.

Notes:

Control box is required for 3-wire, single-phase applications. Data does not include control box. Performance conforms to ISO 9906: 1999 (E) Annex A. Minimum submergence is 5 ft (1.5 m).

- MS 402 motor.
- MS 4000 motor.

4" and larger wells - continued

SP 62S (62 gpm) pump with 6" motor

Pump model	Nom. head [ft]	Motor			Dimensions [in (mm)]					Net weight (complete) [lb]		
		Ph	Volts [V]	[Hp]	[rpm]	A	B	C	D		E	
62S - Motor diameter 6 inch, 60 Hz, rated flow rate 62 gpm (2" NPT)												
-	-	3	208	5	▲	3480	-	23.51 (597)	-	5.50 (139.5)	-	80.0
			230	5	▲	3510	-	23.51 (597)	-	5.50 (139.5)	-	80.0
			460	5	▲	3500	-	23.51 (597)	-	5.50 (139.5)	-	80.0
62S75-14	-	3	288	7.5	▲	3501	76.70 (1948)	23.51 (597)	53.19 (1351)	5.50 (140)	5.50 (140)	119.3
			288	7.5	▲	3501	76.70 (1948)	23.51 (597)	53.19 (1351)	5.50 (140)	5.50 (140)	119.3
			292	7.5	▲	3510	76.70 (1948)	23.51 (597)	53.19 (1351)	5.50 (140)	5.50 (140)	119.3
			291	7.5	▲	3509	76.70 (1948)	23.51 (597)	53.19 (1351)	5.50 (140)	5.50 (140)	119.3
			344	7.5	▲	3478	85.56 (2173)	23.51 (597)	62.05 (1576)	5.50 (140)	5.50 (140)	124.6
62S75-17	-	3	344	7.5	▲	3478	85.56 (2173)	23.51 (597)	62.05 (1576)	5.50 (140)	5.50 (140)	124.6
			347	7.5	▲	3489	85.56 (2173)	23.51 (597)	62.05 (1576)	5.50 (140)	5.50 (140)	124.6
			347	7.5	▲	3488	85.56 (2173)	23.51 (597)	62.05 (1576)	5.50 (140)	5.50 (140)	124.6
			408	10	▲	3486	95.60 (2428)	24.69 (627)	70.91 (1801)	5.50 (140)	5.50 (140)	136.4
62S100-20	-	3	408	10	▲	3486	95.60 (2428)	24.69 (627)	70.91 (1801)	5.50 (140)	5.50 (140)	136.4
			411	10	▲	3497	95.60 (2428)	24.69 (627)	70.91 (1801)	5.50 (140)	5.50 (140)	136.4
			410	10	▲	3496	95.60 (2428)	24.69 (627)	70.91 (1801)	5.50 (140)	5.50 (140)	136.4
			445	10	▲	3474	101.50 (2578)	24.69 (627)	76.82 (1951)	5.50 (140)	5.50 (140)	139.9
62S100-22	-	3	445	10	▲	3474	101.50 (2578)	24.69 (627)	76.82 (1951)	5.50 (140)	5.50 (140)	139.9
			449	10	▲	3486	101.50 (2578)	24.69 (627)	76.82 (1951)	5.50 (140)	5.50 (140)	139.9
			448	10	▲	3485	101.50 (2578)	24.69 (627)	76.82 (1951)	5.50 (140)	5.50 (140)	139.9
			478	10	▲	3460	107.41 (2728)	24.69 (627)	82.72 (2101)	5.50 (140)	5.50 (140)	143.4
62S100-24	-	3	478	10	▲	3460	107.41 (2728)	24.69 (627)	82.72 (2101)	5.50 (140)	5.50 (140)	143.4
			486	10	▲	3474	107.41 (2728)	24.69 (627)	82.72 (2101)	5.50 (140)	5.50 (140)	143.4
			486	10	▲	3473	107.41 (2728)	24.69 (627)	82.72 (2101)	5.50 (140)	5.50 (140)	143.4

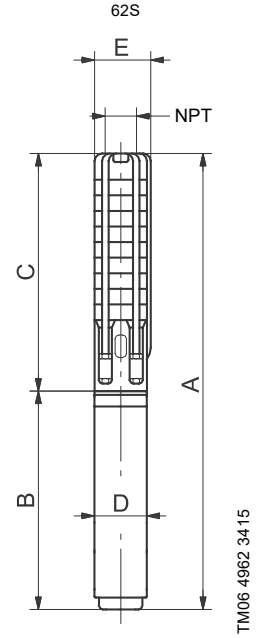

E = Maximum diameter of pump including cable guard and motor.

Notes:

Performance conforms to ISO 9906: 1999 (E) Annex A. Minimum submergence is 5 ft (1.5 m).

▲ MS 6000C motor.

4" and larger wells - continued

SP 77S (77 gpm)

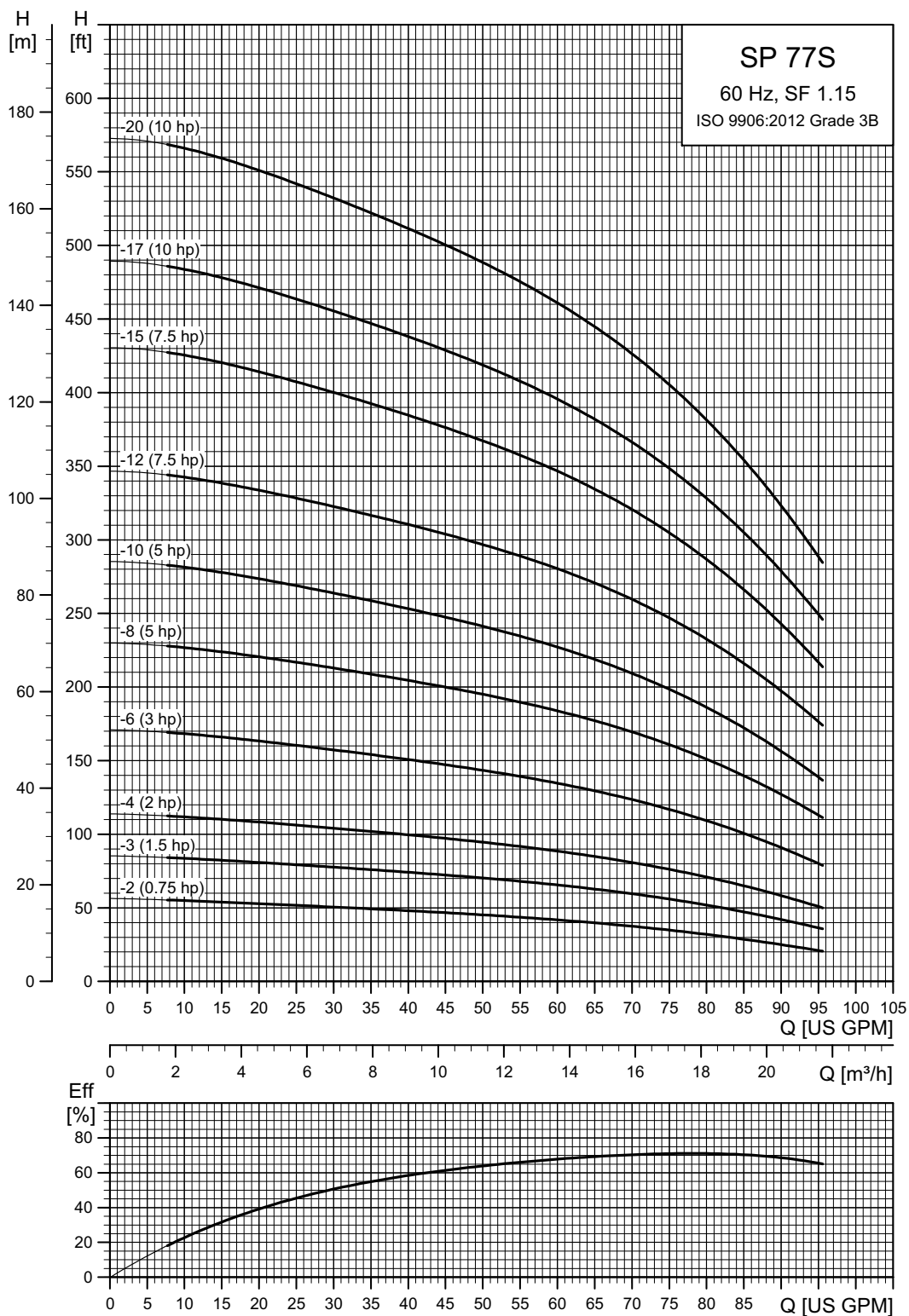

TM06 4620 3215

4" and larger pumps - continued

SP 77S (77 gpm) pump power requirement (P2)

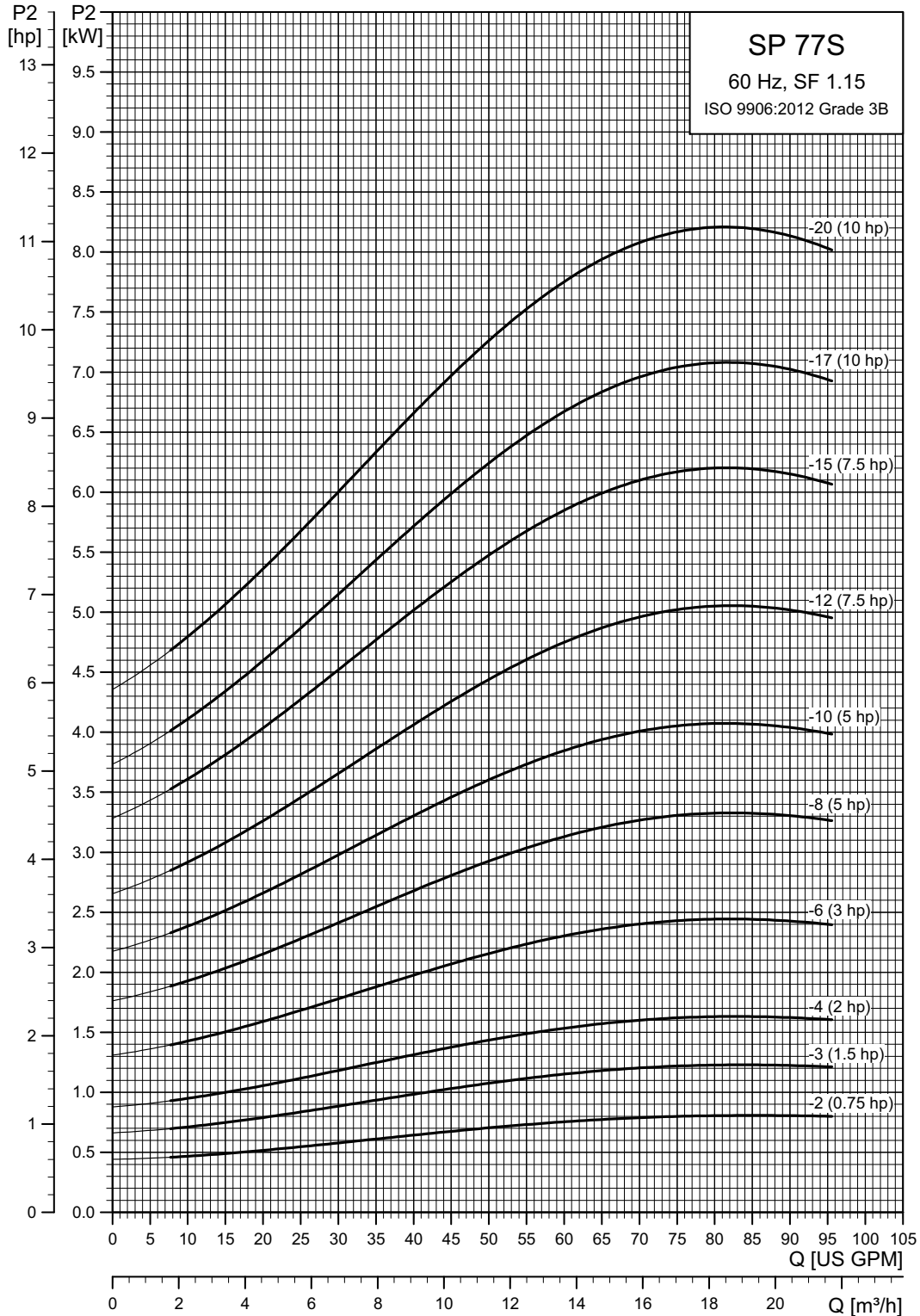

TM06 4621 3215

4" and larger wells - continued

SP 77S (77 gpm) pump with 4" motor

Pump model	Nom. head [ft]	Motor				Dimensions [in (mm)]					Net weight (complete) [lb]	
		Ph	Volts [V]	[Hp]	[rpm]	A	B	C	D	E		
77S - Motor diameter 4-inch, 3-wire motor, 60 Hz, rated flow rate 77 gpm (2" NPT)												
77S07-2	37	1	230	.75	■	3380	28.35 (720)	13.08 (332)	15.28 (388)	3.75 (95)	3.98 (101)	29.7
	38	3	230	.75	■	3401	26.97 (685)	11.70 (297)	15.28 (388)	3.75 (95)	3.98 (101)	26.7
	38	3	460	.75	■	3401	26.97 (685)	11.70 (297)	15.28 (388)	3.75 (95)	3.98 (101)	26.7
77S15-3	61	1	230	1	■	3457	33.47 (850)	15.24 (387)	18.23 (463)	3.75 (95)	3.98 (101)	36.8
	61	3	230	1.5	■	3463	31.89 (810)	13.67 (347)	18.23 (463)	3.75 (95)	3.98 (101)	33.3
	61	3	460	1.5	■	3463	31.89 (810)	13.67 (347)	18.23 (463)	3.75 (95)	3.98 (101)	33.3
77S20-4	77	1	230	2	●	3447	40.75 (1035)	19.57 (497)	21.19 (538)	3.75 (95)	3.98 (101)	54.2
	77	3	230	2	■	3445	36.42 (925)	15.24 (387)	21.19 (538)	3.75 (95)	3.98 (101)	38.8
	77	3	460	2	■	3445	36.42 (925)	15.24 (387)	21.19 (538)	3.75 (95)	3.98 (101)	39.0
77S30-6	113	1	230	3	●	3427	49.81 (1265)	22.72 (577)	27.09 (688)	3.75 (95)	3.98 (101)	66.5
	114	3	208	3	●	3437	45.08 (1145)	18.00 (457)	27.09 (688)	3.75 (95)	3.98 (101)	53.3
	114	3	230	3	●	3437	45.08 (1145)	18.00 (457)	27.09 (688)	3.75 (95)	3.98 (101)	53.3
77S50-8	157	1	230	5	●	3484	59.65 (1515)	26.66 (677)	33.00 (838)	3.75 (95)	3.98 (101)	81.1
	159	3	208	5	●	3503	55.71 (1415)	22.72 (577)	33.00 (838)	3.75 (95)	3.98 (101)	70.1
	159	3	230	5	●	3503	55.71 (1415)	22.72 (577)	33.00 (838)	3.75 (95)	3.98 (101)	70.1
77S50-10	192	1	230	5	●	3449	65.56 (1665)	26.66 (677)	38.90 (988)	3.75 (95)	3.98 (101)	84.6
	195	3	208	5	●	3476	61.62 (1565)	22.72 (577)	38.90 (988)	3.75 (95)	3.98 (101)	73.6
	195	3	230	5	●	3476	61.62 (1565)	22.72 (577)	38.90 (988)	3.75 (95)	3.98 (101)	73.6
77S75-12	237	3	208	7.5	●	3493	71.46 (1815)	26.66 (677)	44.81 (1138)	3.75 (95)	3.98 (101)	88.1
	237	3	230	7.5	●	3493	71.46 (1815)	26.66 (677)	44.81 (1138)	3.75 (95)	3.98 (101)	88.1
	237	3	460	7.5	●	3493	71.46 (1815)	26.66 (677)	44.81 (1138)	3.75 (95)	3.98 (101)	88.1
77S75-15	293	3	208	7.5	●	3463	80.32 (2040)	26.66 (677)	53.67 (1363)	3.75 (95)	3.98 (101)	93.4
	293	3	230	7.5	●	3463	80.32 (2040)	26.66 (677)	53.67 (1363)	3.75 (95)	3.98 (101)	93.4
	293	3	460	7.5	●	3463	80.32 (2040)	26.66 (677)	53.67 (1363)	3.75 (95)	3.98 (101)	93.4
77S100-17	337	3	460	10	●	3484	90.16 (2290)	30.60 (777)	59.57 (1513)	3.75 (95)	3.98 (101)	105.7
	337	3	575	10	●	3484	90.16 (2290)	30.60 (777)	59.57 (1513)	3.75 (95)	3.98 (101)	105.7
77S100-20	392	3	460	10	●	3462	99.02 (2515)	30.60 (777)	68.43 (1738)	3.75 (95)	3.98 (101)	111.0
	392	3	575	10	●	3462	99.02 (2515)	30.60 (777)	68.43 (1738)	3.75 (95)	3.98 (101)	111.0

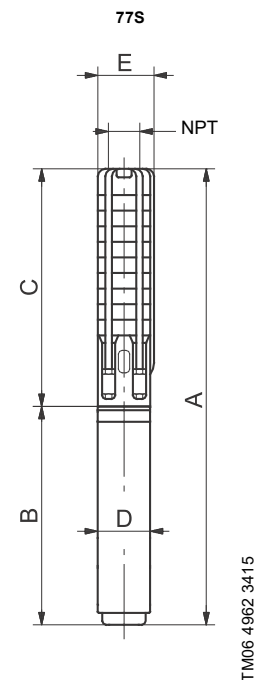

TM06 4962 3415

E = Maximum diameter of pump including cable guard and motor.

Notes:

Control box is required for 3-wire, single-phase applications. Data does not include control box. Performance conforms to ISO 9906: 1999 (E) Annex A. Minimum submergence is 5 ft (1.5 m).

- MS 402 motor.
- MS 4000 motor.

4" and larger wells - continued

SP 77S (77 gpm) pump with 6" motor

Pump model	Nom. head [ft]	Motor				Dimensions [in (mm)]					Net weight (complete) [lb]	
		Ph	Volts [V]	[Hp]	[rpm]	A	B	C	D	E		
77S - Motor diameter 6 inch, 60 Hz, rated flow rate 77 gpm (2" NPT)												
-	-	3	208	5	▲	3480	-	23.51 (597)	-	5.50 (139.5)	-	80.0
			230	5	▲	3510	-	23.51 (597)	-	5.50 (139.5)	-	80.0
			460	5	▲	3500	-	23.51 (597)	-	5.50 (139.5)	-	80.0
77S75-12	-	3	239	7.5	▲	3500	70.79 (1798)	23.51 (597)	47.29 (1201)	5.50 (140)	5.50 (140)	115.8
			239	7.5	▲	3500	70.79 (1798)	23.51 (597)	47.29 (1201)	5.50 (140)	5.50 (140)	115.8
			240	7.5	▲	3509	70.79 (1798)	23.51 (597)	47.29 (1201)	5.50 (140)	5.50 (140)	115.8
77S75-15	-	3	240	7.5	▲	3508	70.79 (1798)	23.51 (597)	47.29 (1201)	5.50 (140)	5.50 (140)	115.8
			295	7.5	▲	3472	79.65 (2023)	23.51 (597)	56.15 (1426)	5.50 (140)	5.50 (140)	121.1
			295	7.5	▲	3472	79.65 (2023)	23.51 (597)	56.15 (1426)	5.50 (140)	5.50 (140)	121.1
77S100-17	-	3	297	7.5	▲	3484	79.65 (2023)	23.51 (597)	56.15 (1426)	5.50 (140)	5.50 (140)	121.1
			297	7.5	▲	3483	79.65 (2023)	23.51 (597)	56.15 (1426)	5.50 (140)	5.50 (140)	121.1
			337	10	▲	3486	86.74 (2203)	24.69 (627)	62.05 (1576)	5.50 (140)	5.50 (140)	131.2
77S100-20	-	3	337	10	▲	3486	86.74 (2203)	24.69 (627)	62.05 (1576)	5.50 (140)	5.50 (140)	131.2
			340	10	▲	3496	86.74 (2203)	24.69 (627)	62.05 (1576)	5.50 (140)	5.50 (140)	131.2
			340	10	▲	3496	86.74 (2203)	24.69 (627)	62.05 (1576)	5.50 (140)	5.50 (140)	131.2
77S100-20	-	3	393	10	▲	3462	95.60 (2428)	24.69 (627)	70.91 (1801)	5.50 (140)	5.50 (140)	136.4
			393	10	▲	3476	95.60 (2428)	24.69 (627)	70.91 (1801)	5.50 (140)	5.50 (140)	136.4
			396	10	▲	3476	95.60 (2428)	24.69 (627)	70.91 (1801)	5.50 (140)	5.50 (140)	136.4
			396	10	▲	3475	95.60 (2428)	24.69 (627)	70.91 (1801)	5.50 (140)	5.50 (140)	136.4

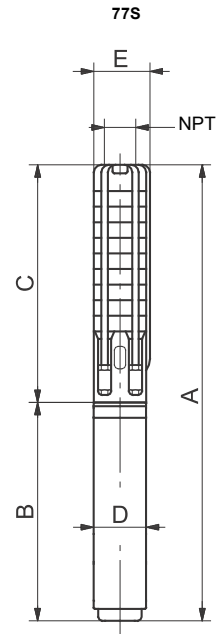

TM06 4962 3415

Notes:

Performance conforms to ISO 9906: 1999 (E) Annex A. Minimum submergence is 5 ft (1.5 m).

▲ MS 6000C motor.

E = Maximum diameter of pump including cable guard and motor.

6" and larger wells

SP 85S (85 gpm)

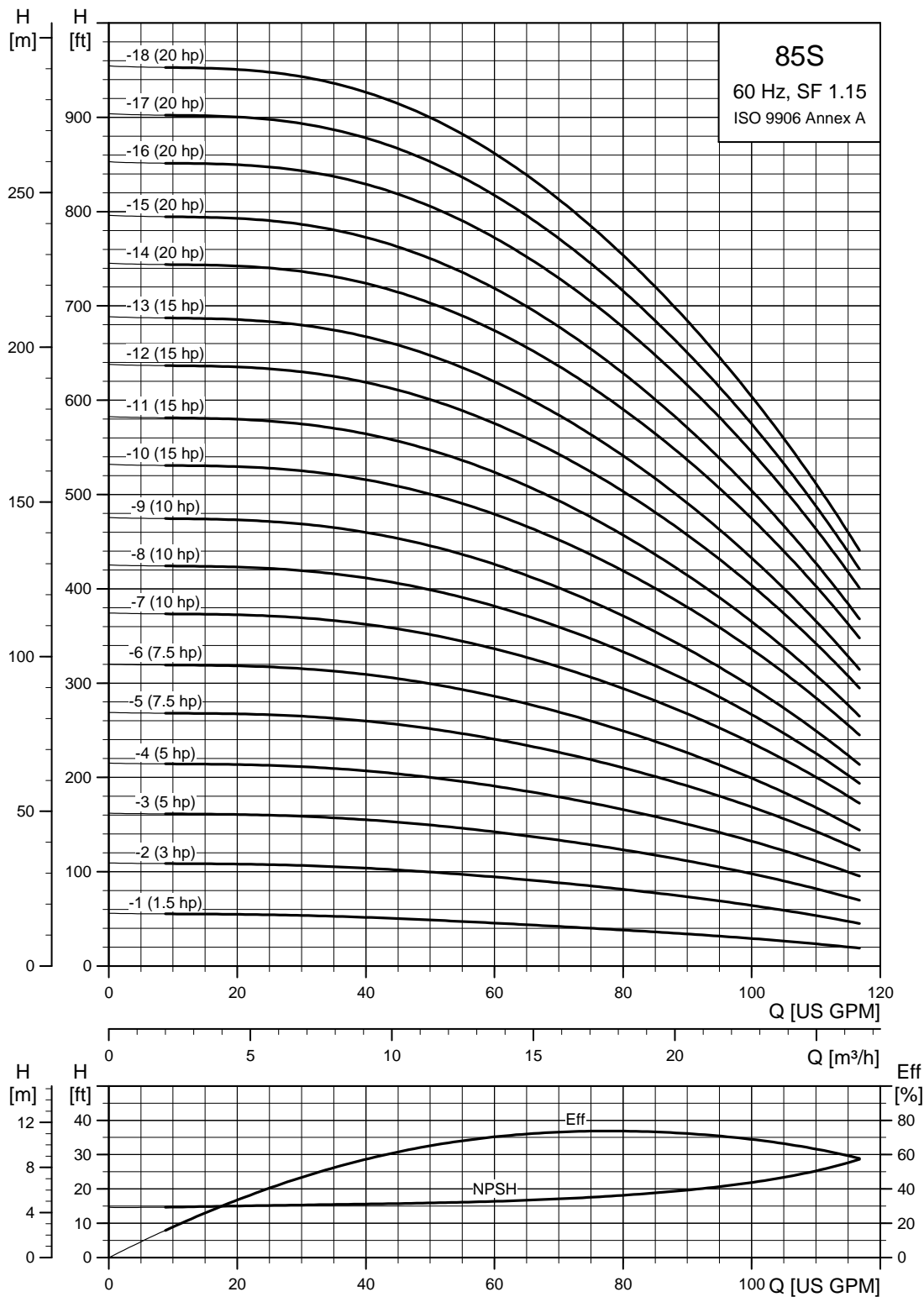

TM05 0235 1812

6" and larger wells - continued

SP 85S (85 gpm)

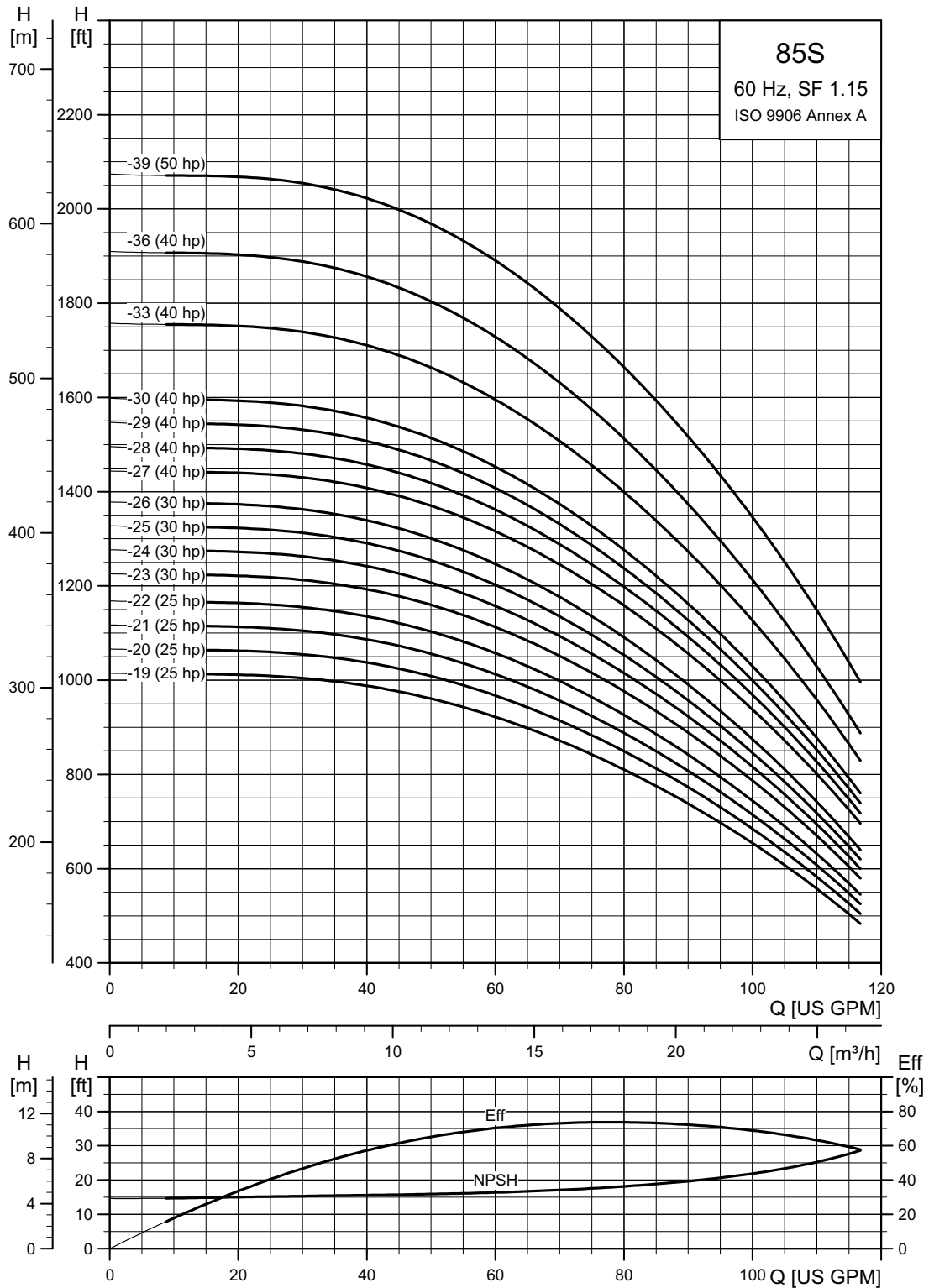

TM05 0236 3815

6" and larger wells - continued

SP 85S (85 gpm) pump power requirement (P2)

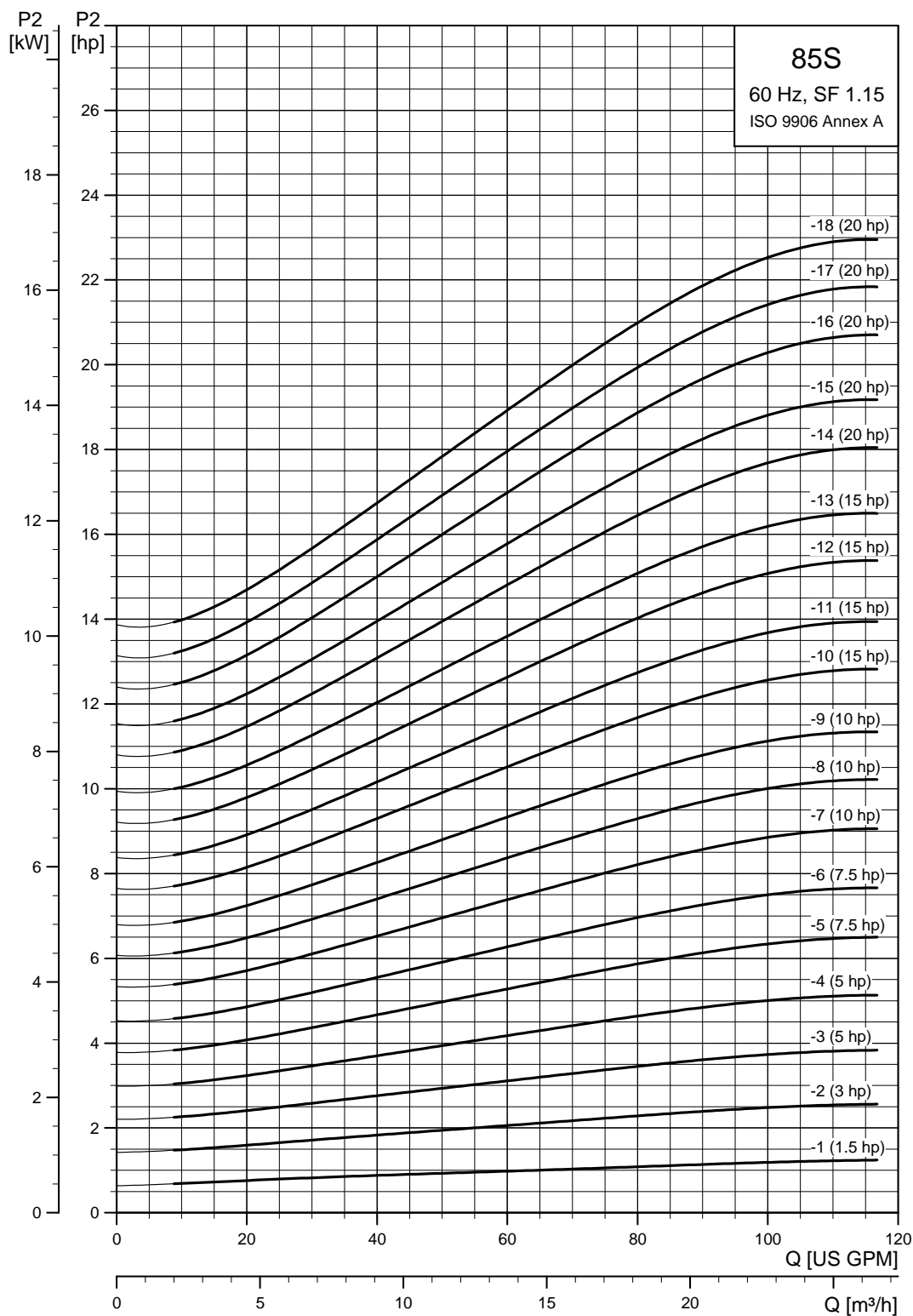

TM05 0237 1812

6" and larger wells - continued

SP 85S (85 gpm) pump power requirement (P2)

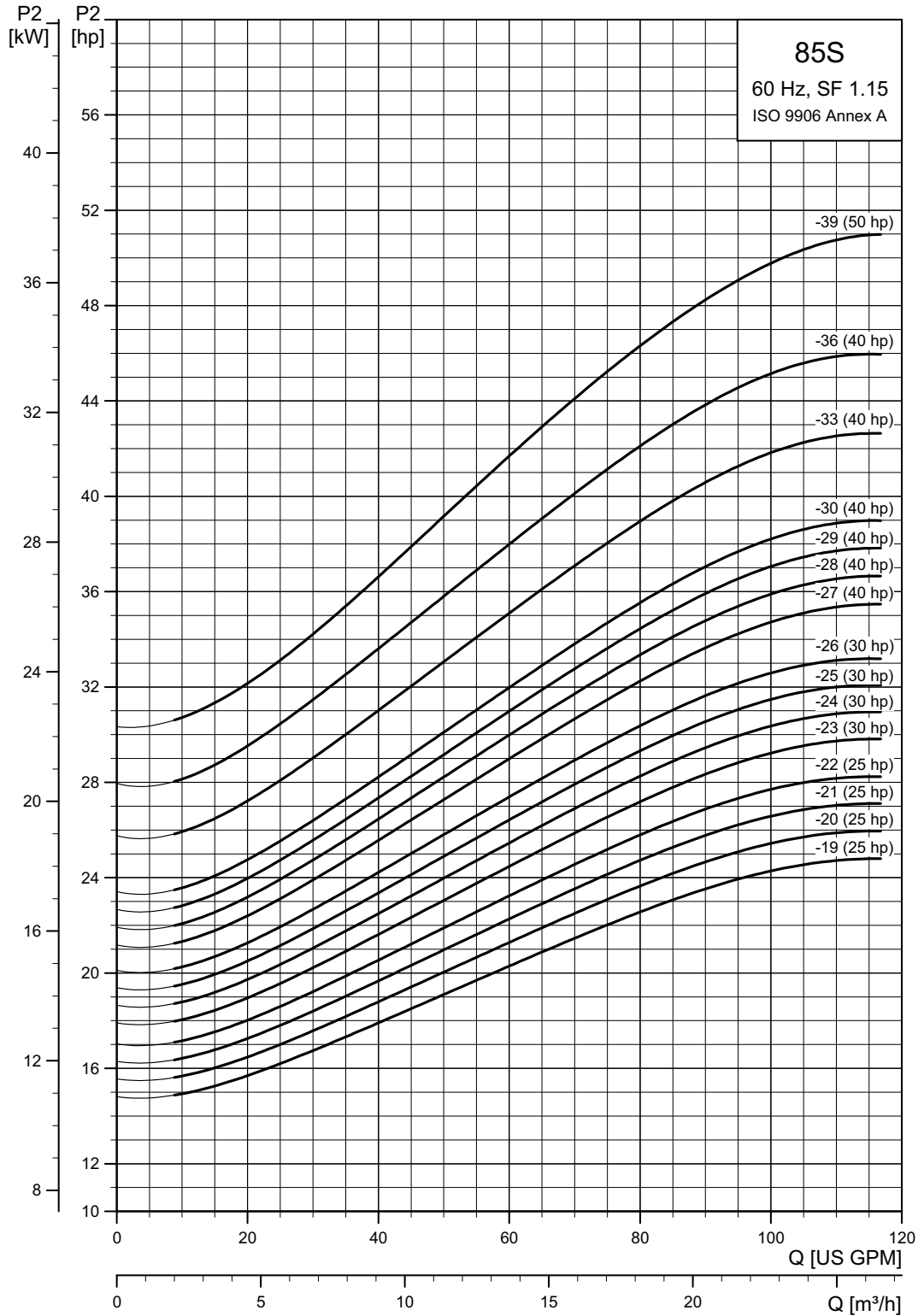

TMM05 0238 3815

6" and larger wells - continued

SP 85S (85 gpm) pump with 4", 6" motors

Pump model	Nom. head [ft]	Motor				Dimensions [in (mm)]					Net weight (complete) [lb]	
		Ph	Volts [V]	[Hp]	[rpm]	A	B	C	D	E		
85S - Motor diameter 4-inch, 3-wire motor, 60 Hz, rated flow rate 85 gpm (3" NPT)												
85S15-1	42	1	230	1.5	■	3519	28.04 (712)	15.24 (387)	12.80 (325)	3.75 (95)	5.28 (134)	29.7
		3	230	1.5	■	3516	26.46 (672)	13.67 (347)	12.80 (325)	3.75 (95)	5.28 (134)	29.7
		3	460	1.5	■	3516	26.46 (672)	13.67 (347)	12.80 (325)	3.75 (95)	5.28 (134)	29.7
85S30-2	87	1	230	3	●	3500	37.88 (962)	22.72 (577)	15.16 (385)	3.75 (95)	5.28 (134)	55.8
		3	230	3	●	3491	33.12 (841)	17.96 (456)	15.16 (385)	3.75 (95)	5.28 (134)	47.7
		3	460	3	●	3517	33.12 (841)	17.96 (456)	15.16 (385)	3.75 (95)	5.28 (134)	47.7
85S50-3	135	1	230	5	●	3520	44.22 (1123)	26.66 (677)	17.56 (446)	3.75 (95)	5.28 (134)	67.5
		3	230	5	●	3531	40.24 (1022)	22.68 (576)	17.56 (446)	3.75 (95)	5.28 (134)	51.3
		3	460	5	●	3530	40.24 (1022)	22.68 (576)	17.56 (446)	3.75 (95)	5.28 (134)	51.3
85S50-4	170	1	230	5	●	3482	46.58 (1183)	26.66 (677)	19.93 (506)	3.75 (95)	5.28 (134)	69.3
		3	230	5	●	3502	42.60 (1082)	22.68 (576)	19.93 (506)	3.75 (95)	5.28 (134)	61.2
		3	460	5	●	3500	42.60 (1082)	22.68 (576)	19.93 (506)	3.75 (95)	5.28 (134)	61.2
85S75-5	215	3	230	7.5	●	3510	48.94 (1243)	26.62 (676)	22.33 (567)	3.75 (95)	5.28 (134)	73.8
		3	460	7.5	●	3510	48.94 (1243)	26.62 (676)	22.33 (567)	3.75 (95)	5.28 (134)	73.8
		3	230	7.5	●	3490	51.30 (1303)	26.62 (676)	24.69 (627)	3.75 (95)	5.28 (134)	85.5
85S75-6	256	3	460	7.5	●	3490	51.30 (1303)	26.62 (676)	24.69 (627)	3.75 (95)	5.28 (134)	76.5
		3	230	7.5	●	3503	57.64 (1464)	30.56 (776)	27.09 (688)	3.75 (95)	5.28 (134)	136.8
		3	460	7.5	●	3488	60.00 (1524)	30.56 (776)	29.45 (748)	3.75 (95)	5.28 (134)	138.6
85S100-9	382	3	460	10	●	3472	62.41 (1585)	30.56 (776)	31.86 (809)	3.75 (95)	5.28 (134)	140.4
85S - Motor diameter 6-inch, 3-wire motor, 60 Hz, rated flow rate 85 gpm (3" NPT)												
-	-	3	208	5	▲	3480	-	23.51 (597)	-	5.50 (139.5)	-	80.0
		3	230	5	▲	3510	-	23.51 (597)	-	5.50 (139.5)	-	80.0
		3	460	5	▲	3500	-	23.51 (597)	-	5.50 (139.5)	-	80.0
85S75-5	216	3	230	7.5	▲	3516	46.58 (1183)	23.51 (597)	23.08 (586)	5.52 (140)	5.52 (140)	98.1
		3	460	7.5	▲	3523	46.58 (1183)	23.51 (597)	23.08 (586)	5.52 (140)	5.52 (140)	98.1
85S75-6	257	3	230	7.5	▲	3498	48.94 (1243)	23.51 (597)	25.44 (646)	5.52 (140)	5.52 (140)	99.9
		3	460	7.5	▲	3507	48.94 (1243)	23.51 (597)	25.44 (646)	5.52 (140)	5.52 (140)	99.9
85S100-7	301	3	230	10	▲	3505	52.52 (1334)	24.69 (627)	27.84 (707)	5.52 (140)	5.52 (140)	103.5
		3	460	10	▲	3513	52.52 (1334)	24.69 (627)	27.84 (707)	5.52 (140)	5.52 (140)	103.5
85S100-8	342	3	230	10	▲	3490	54.89 (1394)	24.69 (627)	30.20 (767)	5.52 (140)	5.52 (140)	105.3
		3	460	10	▲	3500	54.89 (1394)	24.69 (627)	30.20 (767)	5.52 (140)	5.52 (140)	105.3
85S100-9	383	3	230	10	▲	3474	57.29 (1455)	24.69 (627)	32.60 (828)	5.52 (140)	5.52 (140)	108.0
		3	460	10	▲	3486	57.29 (1455)	24.69 (627)	32.60 (828)	5.52 (140)	5.52 (140)	108.0
85S150-10	432	3	230	15	▲	3509	62.01 (1575)	27.05 (687)	34.97 (888)	5.52 (140)	5.52 (140)	122.4
		3	460	15	▲	3513	62.01 (1575)	27.05 (687)	34.97 (888)	5.52 (140)	5.52 (140)	122.4
85S150-11	473	3	230	15	▲	3499	64.41 (1636)	27.05 (687)	37.37 (949)	5.52 (140)	5.52 (140)	126.0
		3	460	15	▲	3503	64.41 (1636)	27.05 (687)	37.37 (949)	5.52 (140)	5.52 (140)	126.0
85S150-12	513	3	230	15	▲	3489	66.78 (1696)	27.05 (687)	39.73 (1009)	5.52 (140)	5.52 (140)	133.2
		3	460	15	▲	3494	66.78 (1696)	27.05 (687)	39.73 (1009)	5.52 (140)	5.52 (140)	133.2
85S150-13	553	3	230	15	▲	3479	69.18 (1757)	27.05 (687)	42.13 (1070)	5.52 (140)	5.52 (140)	135.0
		3	460	15	▲	3484	69.18 (1757)	27.05 (687)	42.13 (1070)	5.52 (140)	5.52 (140)	135.0

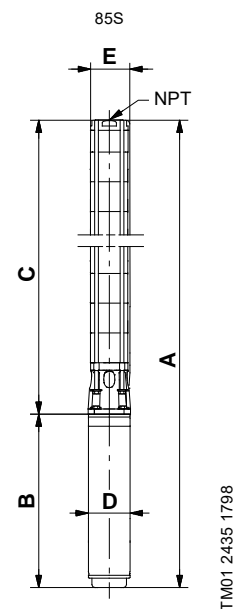

TM01 2435 1798

E = Maximum diameter of pump including cable guard and motor.

Notes:

Control box is required for 3-wire, single-phase applications. Data does not include control box. Performance conforms to ISO 9906. 1999 (E) Annex A. Minimum submergence is 5 ft (1.5 m)

- MS 402 motor.
- MS 4000 motor.
- ▲ MS 6000C motor.

6" and larger wells - continued

SP 85S (85 gpm) pump with 6", 8" motors

Pump model	Nom. head [ft]	Motor				Dimensions [in (mm)]					Net weight complete [lb]	
		Ph	Volts [V]	[Hp]	[rpm]	A	B	C	D	E		
85S - Motor diameter 6 inch, 60 Hz, rated flow rate 85 gpm (3" NPT)												
85S200-14	604	3	230	20	▲	3505	74.10 (1882)	29.61 (752)	44.49 (1130)	5.52 (140)	5.52 (140)	143.1
	607	3	460	20	▲	3513	74.10 (1882)	29.61 (752)	44.49 (1130)	5.52 (140)	5.52 (140)	143.1
85S200-15	644	3	230	20	▲	3497	76.50 (1943)	29.61 (752)	46.89 (1191)	5.52 (140)	5.52 (140)	147.6
	648	3	460	20	▲	3507	76.50 (1943)	29.61 (752)	46.89 (1191)	5.52 (140)	5.52 (140)	147.6
85S200-16	685	3	230	20	▲	3490	78.86 (2003)	29.61 (752)	49.26 (1251)	5.52 (140)	5.52 (140)	157.5
	689	3	460	20	▲	3500	78.86 (2003)	29.61 (752)	49.26 (1251)	5.52 (140)	5.52 (140)	157.5
85S200-17	724	3	230	20	▲	3482	81.26 (2064)	29.61 (752)	51.66 (1312)	5.52 (140)	5.52 (140)	160.2
	729	3	460	20	▲	3493	81.26 (2064)	29.61 (752)	51.66 (1312)	5.52 (140)	5.52 (140)	160.2
85S200-18	764	3	230	20	▲	3474	83.63 (2124)	29.61 (752)	54.02 (1372)	5.52 (140)	5.52 (140)	161.1
	769	3	460	20	▲	3486	83.63 (2124)	29.61 (752)	54.02 (1372)	5.52 (140)	5.52 (140)	179.0
85S250-19	817	3	230	25	▲	3497	88.19 (2240)	31.78 (807)	56.42 (1433)	5.52 (140)	5.52 (140)	191.7
	821	3	460	25	▲	3506	88.19 (2240)	31.78 (807)	56.42 (1433)	5.52 (140)	5.52 (140)	191.7
85S250-20	857	3	230	25	▲	3491	90.56 (2300)	31.78 (807)	58.78 (1493)	5.52 (140)	5.52 (140)	195.3
	862	3	460	25	▲	3501	90.56 (2300)	31.78 (807)	58.78 (1493)	5.52 (140)	5.52 (140)	195.3
85S250-21	897	3	230	25	▲	3485	92.96 (2361)	31.78 (807)	61.19 (1554)	5.52 (140)	5.52 (140)	198.0
	902	3	460	25	▲	3496	92.96 (2361)	31.78 (807)	61.19 (1554)	5.52 (140)	5.52 (140)	198.0
85S250-22	936	3	230	25	▲	3479	95.32 (2421)	31.78 (807)	63.55 (1614)	5.52 (140)	5.52 (140)	199.8
	942	3	460	25	▲	3490	95.32 (2421)	31.78 (807)	63.55 (1614)	5.52 (140)	5.52 (140)	199.8
85S300-23	984	3	230	30	▲	3487	100.08 (2542)	34.14 (867)	65.95 (1675)	5.52 (140)	5.52 (140)	199.8
	989	3	460	30	▲	3498	100.08 (2542)	34.14 (867)	65.95 (1675)	5.52 (140)	5.52 (140)	199.8
85S300-24	1023	3	230	30	▲	3482	102.45 (2602)	34.14 (867)	68.31 (1735)	5.52 (140)	5.52 (140)	216.0
	1030	3	460	30	▲	3493	102.45 (2602)	34.14 (867)	68.31 (1735)	5.52 (140)	5.52 (140)	216.0
85S300-25	1063	3	230	30	▲	3476	104.85 (2663)	34.14 (867)	70.71 (1796)	5.52 (140)	5.52 (140)	219.6
	1070	3	460	30	▲	3488	104.85 (2663)	34.14 (867)	70.71 (1796)	5.52 (140)	5.52 (140)	219.6
85S300-26	1102	3	230	30	▲	3471	107.21 (2723)	34.14 (867)	73.08 (1856)	5.52 (140)	5.52 (140)	221.4
	1110	3	460	30	▲	3483	107.21 (2723)	34.14 (867)	73.08 (1856)	5.52 (140)	5.52 (140)	221.4
85S400-27	1171	3	460	40	▲	3512	109.61 (2784)	34.14 (867)	75.48 (1917)	5.52 (140)	5.52 (140)	234.9
85S400-28	1212	3	460	40	▲	3508	117.09 (2974)	39.26 (997)	77.84 (1977)	5.52 (140)	5.52 (140)	246.6
85S400-29	1253	3	460	40	▲	3505	119.49 (3035)	39.26 (997)	80.24 (2038)	5.52 (140)	5.52 (140)	248.4
85S400-30	1294	3	460	40	▲	3501	121.86 (3095)	39.26 (997)	82.60 (2098)	5.52 (140)	5.52 (140)	270.0
85S400-33DS	1416	3	460	40	▲	3490	142.88 (3629)	39.26 (997)	103.63 (2632)	5.52 (140)	6.89 (175)	515.5
85S400-36DS	1535	3	460	40	▲	3479	150.00 (3810)	39.26 (997)	110.75 (2813)	5.52 (140)	6.89 (175)	454.8
85S500-39DS	1670	3	460	50	☆	3487	173.94 (4418)	56.03 (1423)	117.92 (2995)	5.63 (143)	6.89 (175)	469.0
85S - Motor diameter 8 inch, 60 Hz, rated flow rate 85 gpm (3" NPT)												
85S400-33DS	1427	3	460	40	*	3505	145.12 (3686)	43.71 (1110)	101.42 (2576)	7.56 (192)	7.56 (192)	652.7
85S400-36DS	1549	3	460	40	*	3496	152.25 (3867)	43.71 (1110)	108.55 (2757)	7.56 (192)	7.56 (192)	592.0
85S400-39DS	1690	3	460	50	*	3508	159.41 (4049)	43.71 (1110)	115.71 (2939)	7.56 (192)	7.56 (192)	537.2

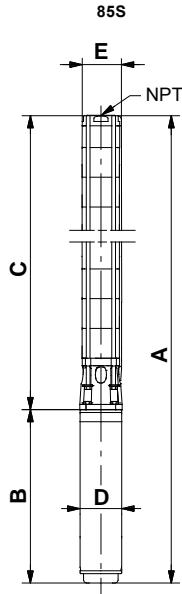

E = Maximum diameter of pump including cable guard and motor.

TM01 2435 1798

Notes:

Control box is required for 3-wire, single-phase applications. Data does not include control box.

DS designation = Built into sleeve, 3" NPT, 8" minimum well diameter.

Performance conforms to ISO 9906: 1999 (E) Annex A. Minimum submergence is 5 ft (1.5 m).

- ▲ MS 6000C motor.
- ☆ Takes MMS 6 motor; not available as complete.
- * Takes MMS 8000 motor; not available as complete.

6" and larger wells - continued

SP 150S (150 gpm)

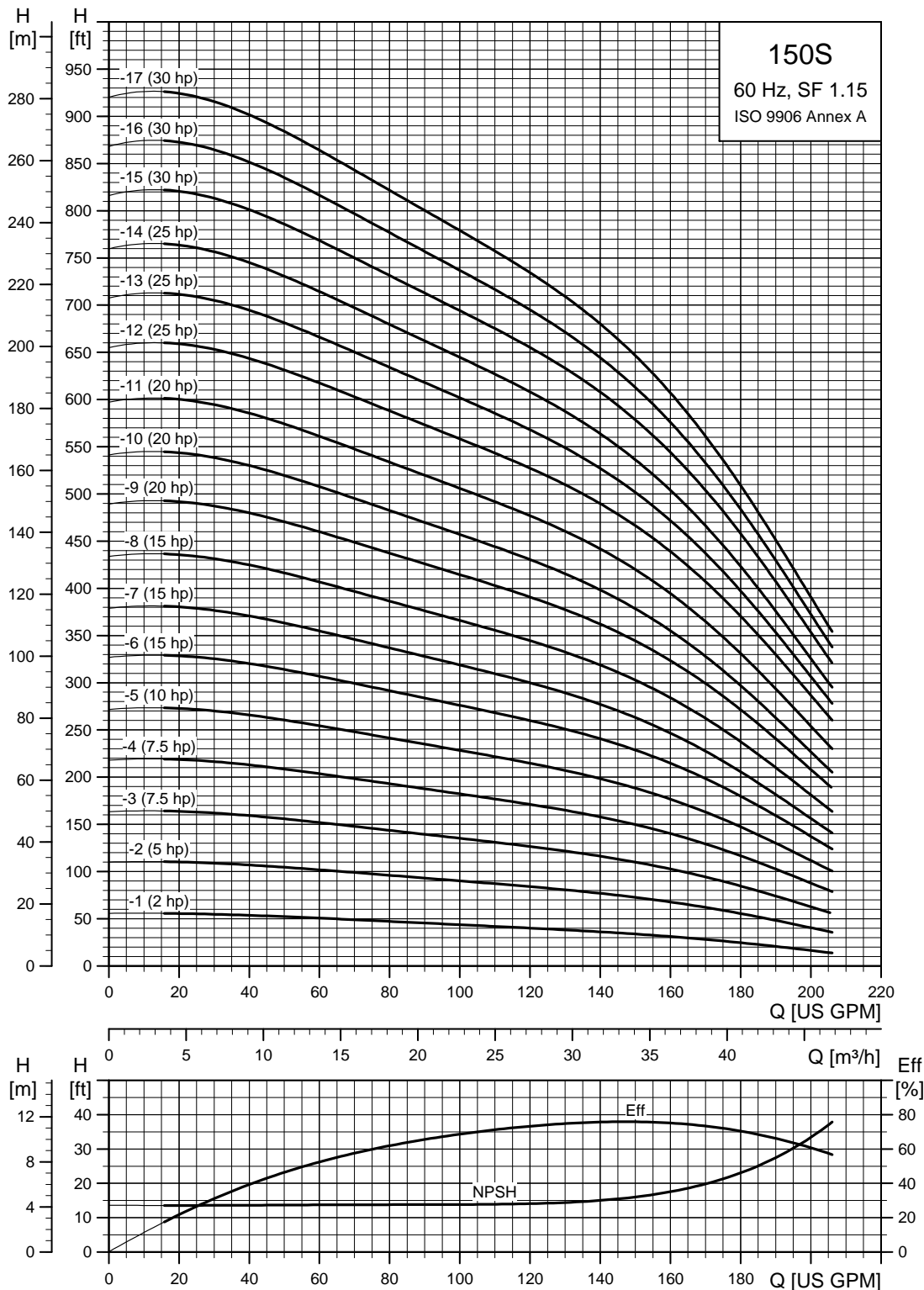

TM05 0239 1812

6" and larger wells - continued

SP 150S (150 gpm)

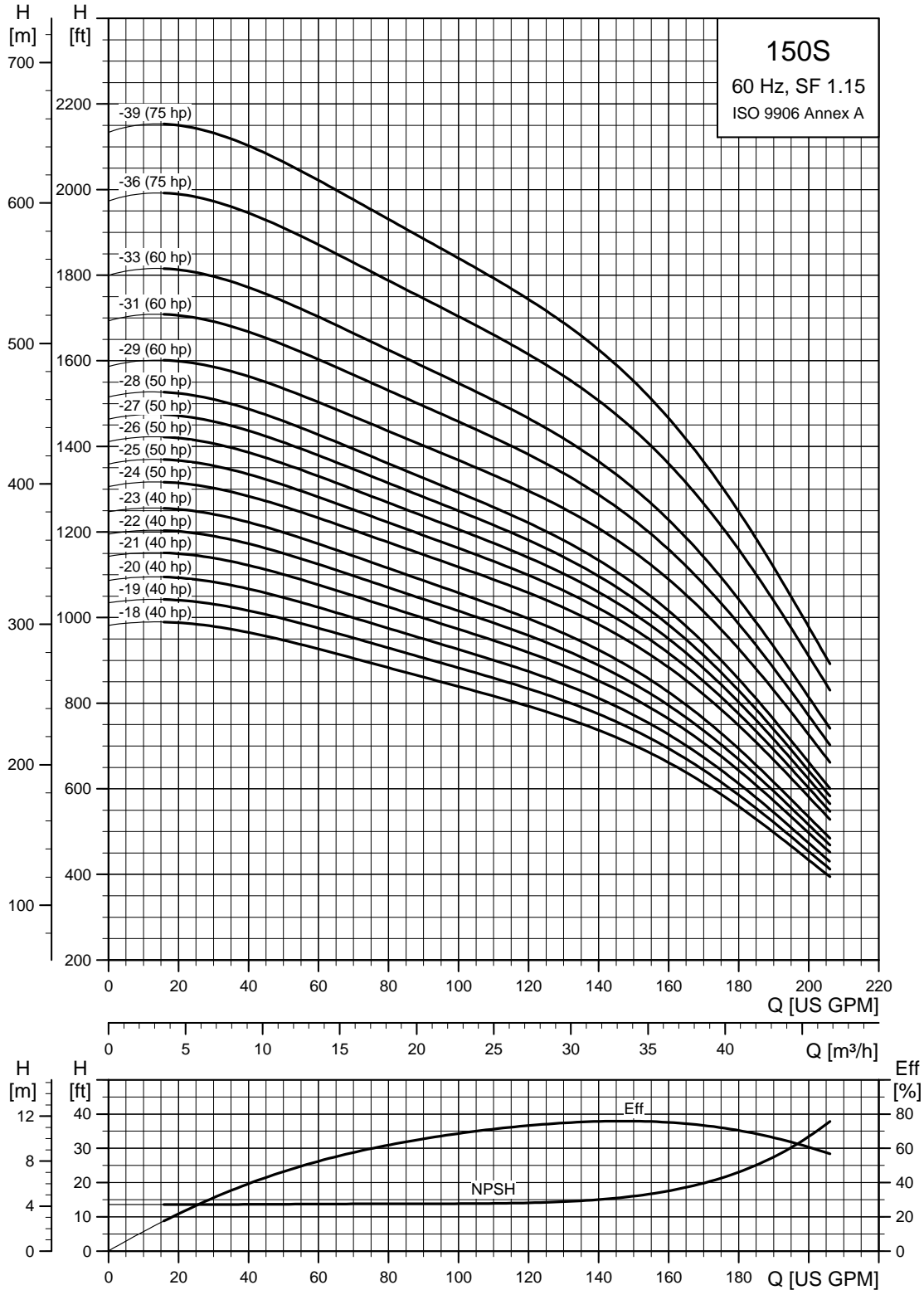

TM05 0240 1812

6" and larger wells - continued

SP 150S (150 gpm) pump power requirement (P2)

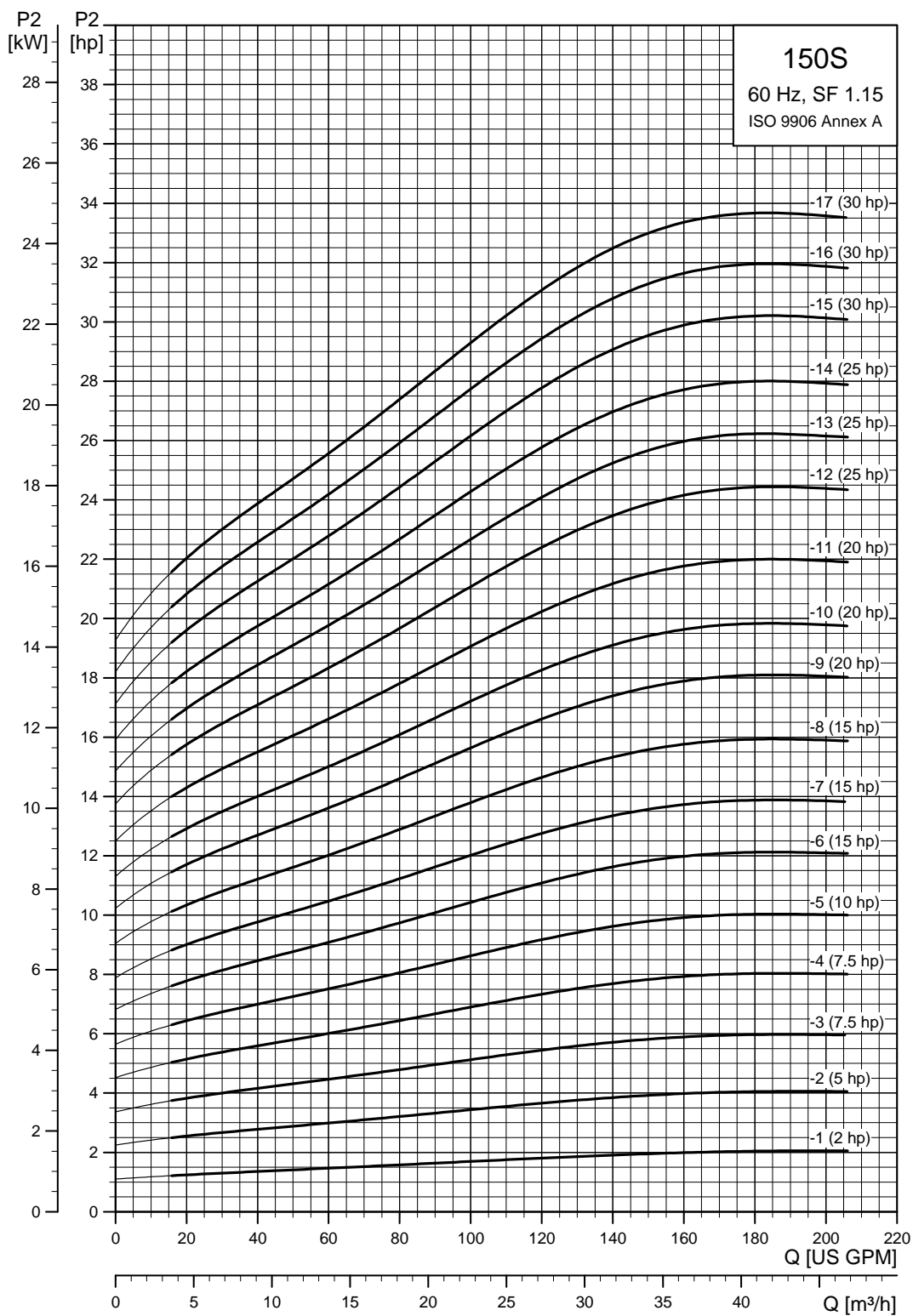

TM05 0241 1812

6" and larger wells - continued

SP 150S (150 gpm) pump power requirement (P2)

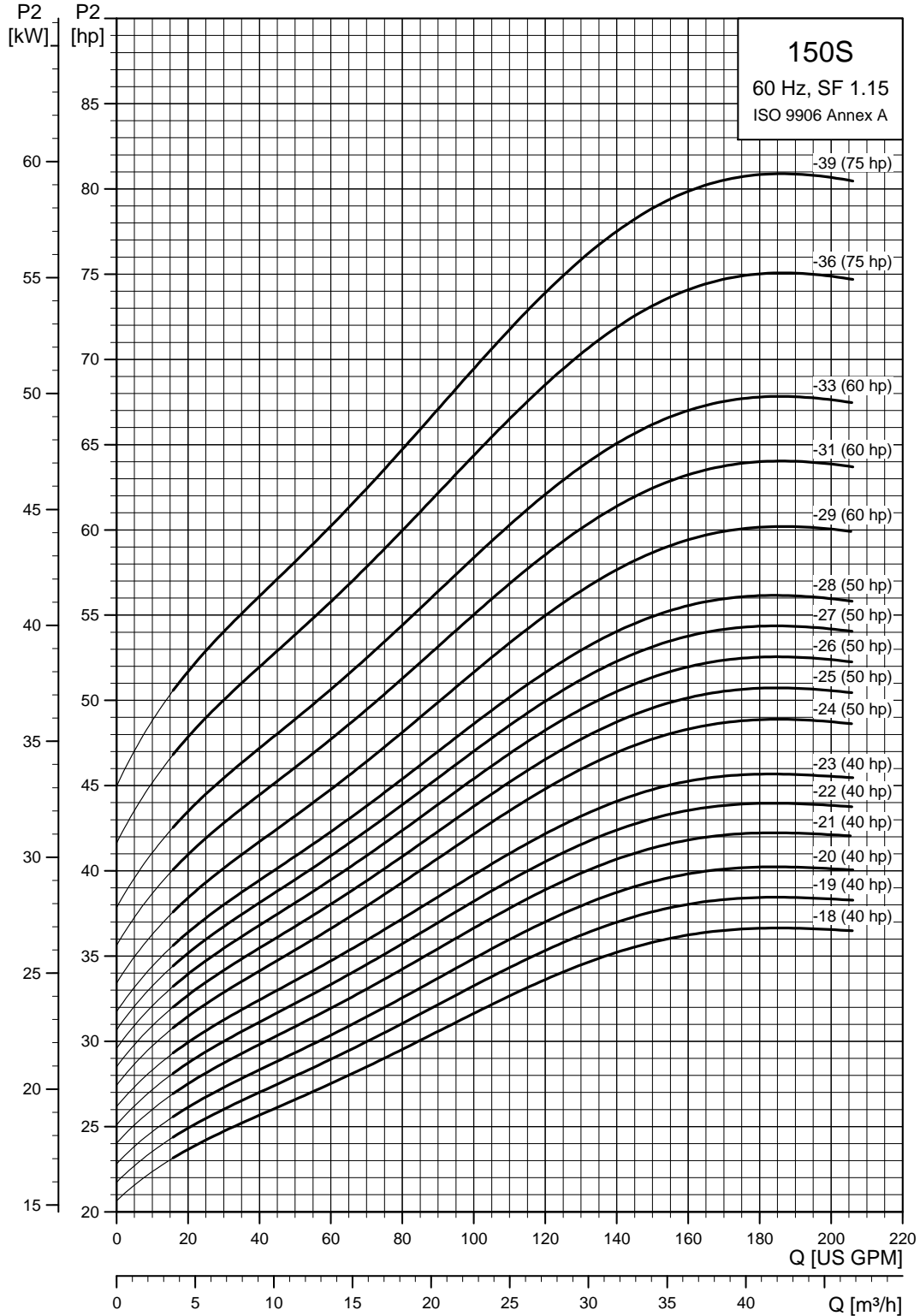

6" and larger wells - continued

SP 150S (150 gpm) pump with 4" motor

Pump model	Nom. head [ft]	Motor				Dimensions [in (mm)]					Net weight (complete) [lb]
		Ph	Volts [V]	[Hp]	[rpm]	A	B	C	D	E	
150S - Motor diameter 4-inch, 3-wire motor, 60 Hz, rated flow rate 150 gpm (3" NPT)											
150S20-1	39	1	230	2	● 3477	33.67 (855)	19.57 (497)	14.10 (358)	3.75 (95)	5.28 (134)	49.5
	39	3	230	2	■ 3474	29.34 (745)	15.24 (387)	14.10 (358)	3.75 (95)	5.28 (134)	45.0
	39	3	460	2	■ 3474	29.34 (745)	15.24 (387)	14.10 (358)	3.75 (95)	5.28 (134)	45.0
150S50-2	78	1	230	5	● 3502	44.53 (1131)	26.66 (677)	17.88 (454)	3.75 (95)	5.28 (134)	67.5
	79	3	230	5	● 3517	40.56 (1030)	22.68 (576)	17.88 (454)	3.75 (95)	5.28 (134)	42.3
150S75-3	79	3	460	5	● 3516	40.56 (1030)	22.68 (576)	17.88 (454)	3.75 (95)	5.28 (134)	42.3
	118	3	230	7.5	● 3508	48.27 (1226)	26.62 (676)	21.66 (550)	3.75 (95)	5.28 (134)	51.3
150S75-4	118	3	460	7.5	● 3508	48.27 (1226)	26.62 (676)	21.66 (550)	3.75 (95)	5.28 (134)	82.8
	154	3	230	7.5	● 3473	52.05 (1322)	26.62 (676)	25.44 (646)	3.75 (95)	5.28 (134)	85.5
150S100-5	154	3	460	7.5	● 3473	52.05 (1322)	26.62 (676)	25.44 (646)	3.75 (95)	5.28 (134)	85.5
	195	3	460	10	● 3481	59.77 (1518)	30.56 (776)	29.22 (742)	3.75 (95)	5.28 (134)	135.9

150S - Motor diameter 6 inch, 60 Hz, rated flow rate 150 gpm (3" NPT)											
-	-	3	208	5	▲ 3480	-	23.51 (597)	-	5.50 (139.5)	-	80.0
			230	5	▲ 3510	-	23.51 (597)	-	5.50 (139.5)	-	80.0
			460	5	▲ 3500	-	23.51 (597)	-	5.50 (139.5)	-	80.0
150S75-4	155	3	230	7.5	▲ 3482	49.69 (1262)	23.51 (597)	26.19 (665)	5.52 (140)	5.52 (140)	99.9
	156	3	460	7.5	▲ 3493	49.69 (1262)	23.51 (597)	26.19 (665)	5.52 (140)	5.52 (140)	99.9
150S100-5	195	3	230	10	▲ 3482	54.65 (1388)	24.69 (627)	29.97 (761)	5.52 (140)	5.52 (140)	73.8
	196	3	460	10	▲ 3493	54.65 (1388)	24.69 (627)	29.97 (761)	5.52 (140)	5.52 (140)	73.8
150S150-6	238	3	230	15	▲ 3508	60.79 (1544)	27.05 (687)	33.75 (857)	5.52 (140)	5.52 (140)	119.7
	239	3	460	15	▲ 3511	60.79 (1544)	27.05 (687)	33.75 (857)	5.52 (140)	5.52 (140)	119.7
150S150-7	276	3	230	15	▲ 3492	64.57 (1640)	27.05 (687)	37.52 (953)	5.52 (140)	5.52 (140)	127.8
	277	3	460	15	▲ 3496	64.57 (1640)	27.05 (687)	37.52 (953)	5.52 (140)	5.52 (140)	127.8
150S150-8	313	3	230	15	▲ 3474	68.35 (1736)	27.05 (687)	41.30 (1049)	5.52 (140)	5.52 (140)	137.7
	314	3	460	15	▲ 3480	68.35 (1736)	27.05 (687)	41.30 (1049)	5.52 (140)	5.52 (140)	137.7
150S200-9	357	3	230	20	▲ 3496	74.69 (1897)	29.61 (752)	45.08 (1145)	5.52 (140)	5.52 (140)	141.3
	359	3	460	20	▲ 3506	74.69 (1897)	29.61 (752)	45.08 (1145)	5.52 (140)	5.52 (140)	141.3
150S200-10	395	3	230	20	▲ 3484	78.47 (1993)	29.61 (752)	48.86 (1241)	5.52 (140)	5.52 (140)	151.2
	397	3	460	20	▲ 3495	78.47 (1993)	29.61 (752)	48.86 (1241)	5.52 (140)	5.52 (140)	151.2
150S200-11	431	3	230	20	▲ 3471	82.25 (2089)	29.61 (752)	52.64 (1337)	5.52 (140)	5.52 (140)	166.5
	435	3	460	20	▲ 3483	82.25 (2089)	29.61 (752)	52.64 (1337)	5.52 (140)	5.52 (140)	166.5
150S250-12	477	3	230	25	▲ 3490	88.19 (2240)	31.78 (807)	56.42 (1433)	5.52 (140)	5.52 (140)	188.1
	479	3	460	25	▲ 3500	88.19 (2240)	31.78 (807)	56.42 (1433)	5.52 (140)	5.52 (140)	188.1
150S250-13	514	3	230	25	▲ 3480	91.97 (2336)	31.78 (807)	60.20 (1529)	5.52 (140)	5.52 (140)	201.6
	517	3	460	25	▲ 3492	91.97 (2336)	31.78 (807)	60.20 (1529)	5.52 (140)	5.52 (140)	201.6
150S250-14	550	3	230	25	▲ 3470	95.75 (2432)	31.78 (807)	63.98 (1625)	5.52 (140)	5.52 (140)	206.1
	554	3	460	25	▲ 3482	95.75 (2432)	31.78 (807)	63.98 (1625)	5.52 (140)	5.52 (140)	206.1

Notes:

Control box is required for 3-wire, single-phase applications. Data does not include control box. Performance conforms to ISO 9906. 1999 (E) Annex A. Minimum submergence is 5 ft (1.5 m).

- MS 402 motor.
- MS 4000 motor.
- ▲ MS 6000C motor.

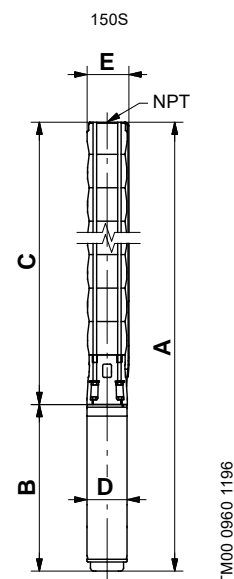

E = Maximum diameter of pump including cable guard and motor.

6" and larger wells - continued

SP 150S (150 gpm) pump with 6", 8" motor

Pump model	Nom. head [ft]	Motor				Dimensions [in (mm)]					Net weight (complete) [lb]
		Ph	Volts [V]	[Hp]	[rpm]	A	B	C	D	E	
150S - Motor diameter 6 inch, 60 Hz, rated flow rate 150 gpm (3" NPT)											
150S300-15	592	3	230	30	▲ 3476	101.89 (2588)	34.14 (867)	67.76 (1721)	5.52 (140)	5.52 (140)	209.7
	596	3	460	30	▲ 3488	101.89 (2588)	34.14 (867)	67.76 (1721)	5.52 (140)	5.52 (140)	209.7
150S300-16	628	3	230	30	▲ 3466	105.67 (2684)	34.14 (867)	71.54 (1817)	5.52 (140)	5.52 (140)	211.5
	633	3	460	30	▲ 3479	105.67 (2684)	34.14 (867)	71.54 (1817)	5.52 (140)	5.52 (140)	211.5
150S300-17	664	3	230	30	▲ 3456	109.45 (2780)	34.14 (867)	75.32 (1913)	5.52 (140)	5.52 (140)	216.0
	670	3	460	30	▲ 3471	109.45 (2780)	34.14 (867)	75.32 (1913)	5.52 (140)	5.52 (140)	216.0
150S400-18	721	3	460	40	▲ 3501	118.35 (3006)	39.26 (997)	79.10 (2009)	5.52 (140)	5.52 (140)	246.6
150S400-19	759	3	460	40	▲ 3495	122.13 (3102)	39.26 (997)	82.88 (2105)	5.52 (140)	5.52 (140)	248.4
150S400-20	797	3	460	40	▲ 3489	125.91 (3198)	39.26 (997)	86.66 (2201)	5.52 (140)	5.52 (140)	291.0
150S400-21	834	3	460	40	▲ 3483	129.69 (3294)	39.26 (997)	90.44 (2297)	5.52 (140)	5.52 (140)	271.8
150S400-22	871	3	460	40	▲ 3476	133.47 (3390)	39.26 (997)	94.22 (2393)	5.52 (140)	5.52 (140)	305.9
150S400-23	907	3	460	40	▲ 3470	137.25 (3486)	39.26 (997)	98.00 (2489)	5.52 (140)	5.52 (140)	277.2
150S500-24	954	3	460	50	☼ 3483	157.88 (4010)	56.11 (1425)	101.78 (2585)	5.67 (144)	5.67 (144)	411.8
150S500-25	991	3	460	50	☼ 3478	161.66 (4106)	56.11 (1425)	105.56 (2681)	5.67 (144)	5.67 (144)	419.0
150S500-26	1028	3	460	50	☼ 3473	165.44 (4202)	56.11 (1425)	109.34 (2777)	5.67 (144)	5.67 (144)	426.2
150S500-27	1064	3	460	50	☼ 3467	169.22 (4298)	56.11 (1425)	113.12 (2873)	5.67 (144)	5.67 (144)	433.4
150S500-28	1100	3	460	50	☼ 3462	173.00 (4394)	56.11 (1425)	116.89 (2969)	5.67 (144)	5.67 (144)	440.6
150S600-29DS	1131	3	460	60	☼ 3465	190.64 (4842)	56.11 (1425)	134.53 (3417)	5.67 (144)	6.89 (175)	605.0
150S600-31DS	1209	3	460	60	☼ 3455	198.20 (5034)	56.11 (1425)	142.09 (3609)	5.67 (144)	6.89 (175)	617.0
150S600-33DS	1288	3	460	60	☼ 3446	205.76 (5226)	56.11 (1425)	149.65 (3801)	5.67 (144)	6.89 (175)	629.0
150S - Motor diameter 8 inch, 60 Hz, rated flow rate 150 gpm (3" NPT)											
150S500-24	966	3	460	50	* 3505	162.45 (4126)	45.67 (1160)	116.78 (2966)	7.56 (192)	7.56 (192)	484.5
150S500-25	1004	3	460	50	* 3501	166.23 (4222)	45.67 (1160)	120.56 (3062)	7.56 (192)	7.56 (192)	491.7
150S500-26	1042	3	460	50	* 3497	170.00 (4318)	45.67 (1160)	124.34 (3158)	7.56 (192)	7.56 (192)	498.9
150S500-27	1080	3	460	50	* 3493	173.78 (4414)	45.67 (1160)	128.12 (3254)	7.56 (192)	7.56 (192)	506.1
150S500-28	1117	3	460	50	* 3489	177.56 (4510)	45.67 (1160)	131.89 (3350)	7.56 (192)	7.56 (192)	513.3
150S600-29DS	1177	3	460	60	* 3519	182.33 (4631)	50.00 (1270)	132.33 (3361)	7.56 (192)	7.56 (192)	612.7
150S600-31DS	1255	3	460	60	* 3513	189.89 (4823)	50.00 (1270)	139.89 (3553)	7.56 (192)	7.56 (192)	623.7
150S600-33DS	1332	3	460	60	* 3508	197.45 (5015)	50.00 (1270)	147.45 (3745)	7.56 (192)	7.56 (192)	639.1
150S750-36DS	1467	3	460	75	* 3524	211.93 (5383)	53.15 (1350)	158.78 (4033)	7.56 (192)	7.56 (192)	689.2
150S750-39DS	1584	3	460	75	* 3518	223.27 (5671)	53.15 (1350)	170.12 (4321)	7.56 (192)	7.56 (192)	704.6

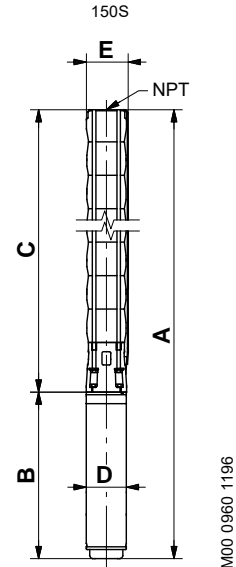

TM00 0960 1196

E = Maximum diameter of pump including cable guard and motor.

Notes:

Control box is required for 3-wire, single-phase applications. Data does not include control box.

DS designation = Built into sleeve, 3" NPT, 8" minimum well diameter.

Performance conforms to ISO 9906: 1999 (E) Annex A. Minimum submergence is 5 ft (1.5 m).

- ▲ MS 6000C motor.
- ☼ Takes MMS 6 motor; not available as complete.
- * Takes MMS 8000 motor; not available as complete.

6" and larger wells - continued

SP 230S (230 gpm)

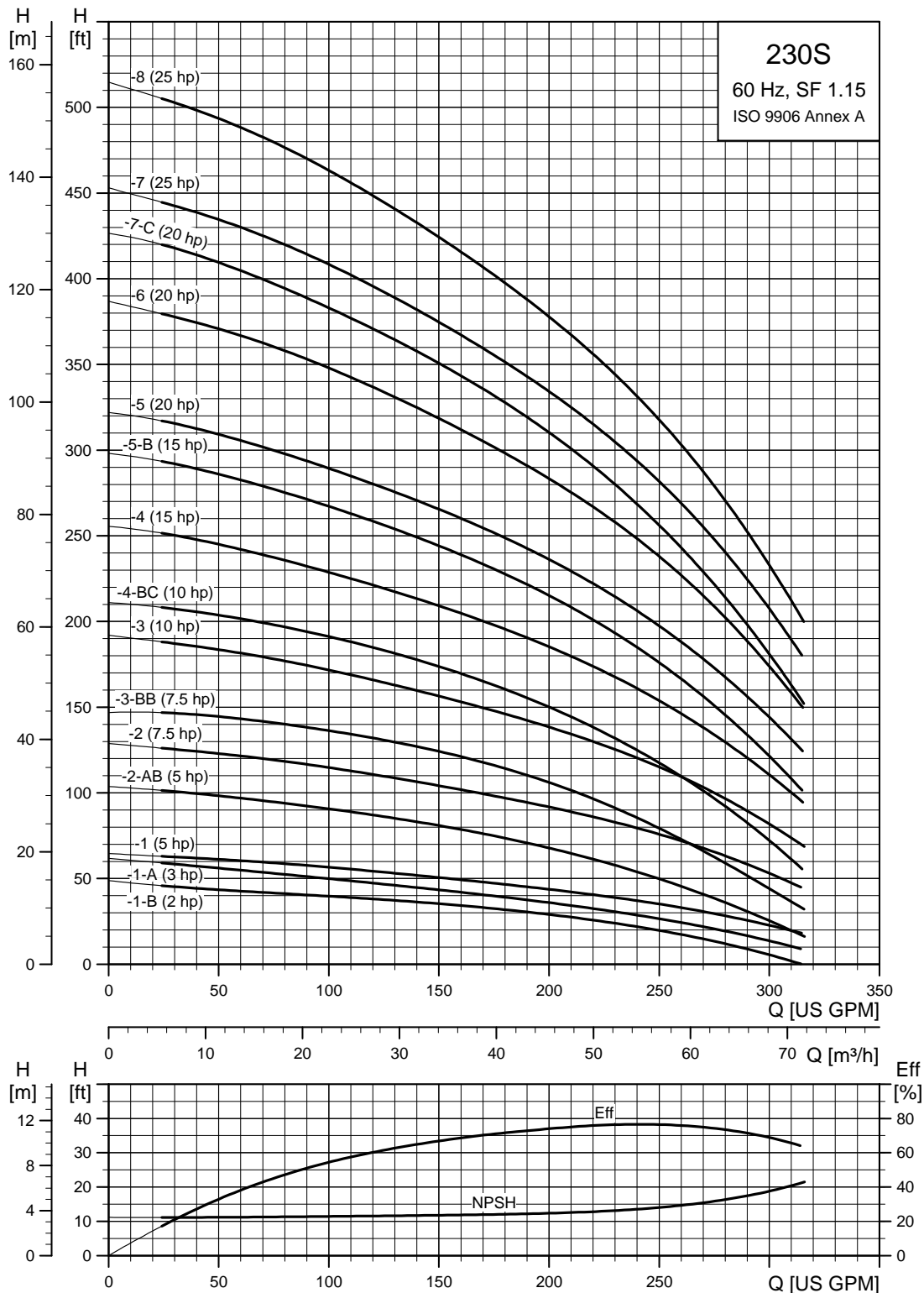

TM05 0243 1812

6" and larger wells - continued

SP 230S (230 gpm)

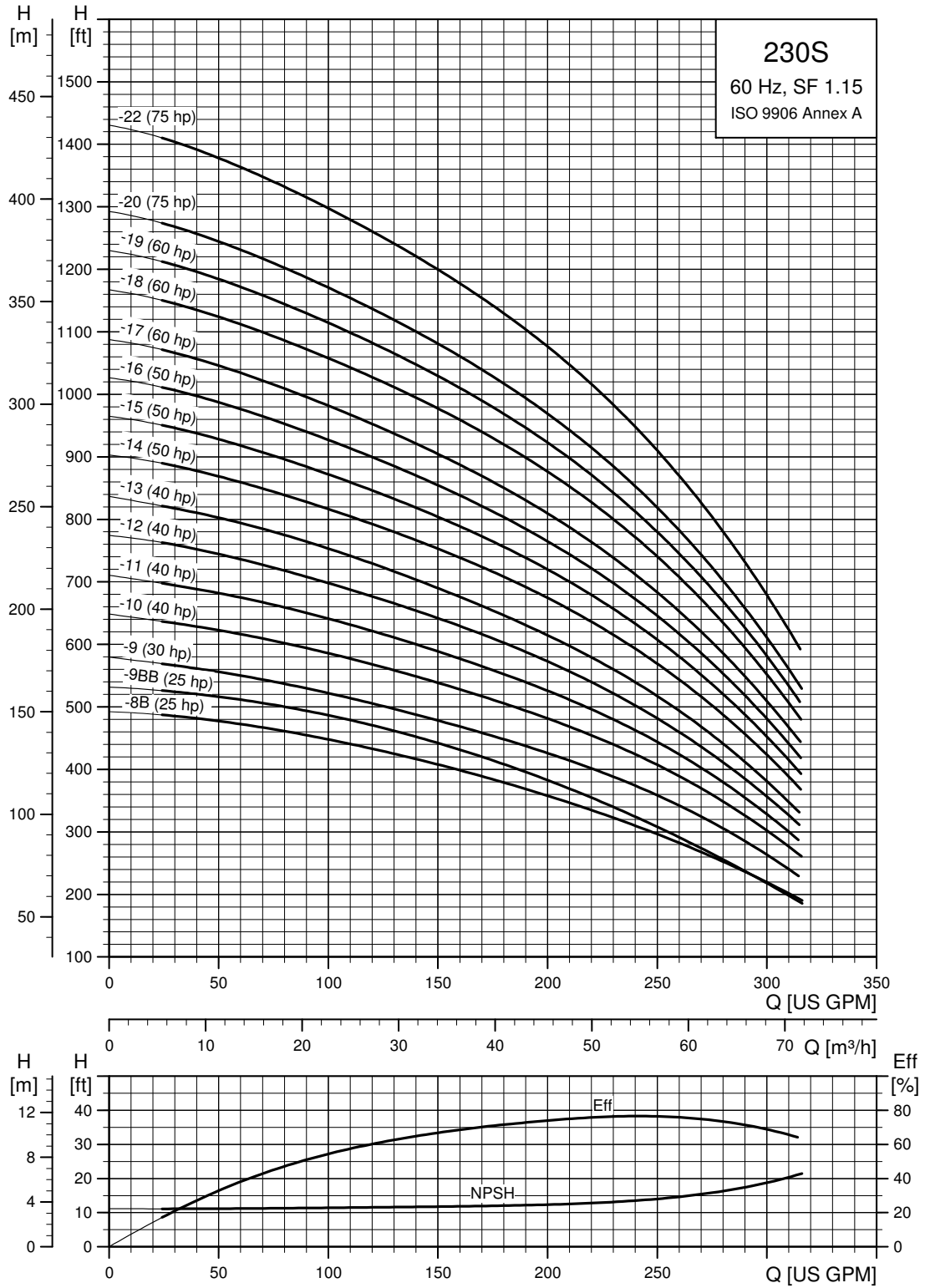

TM05 0244 5014

6" and larger wells - continued

SP 230S (230 gpm) pump power requirement (P2)

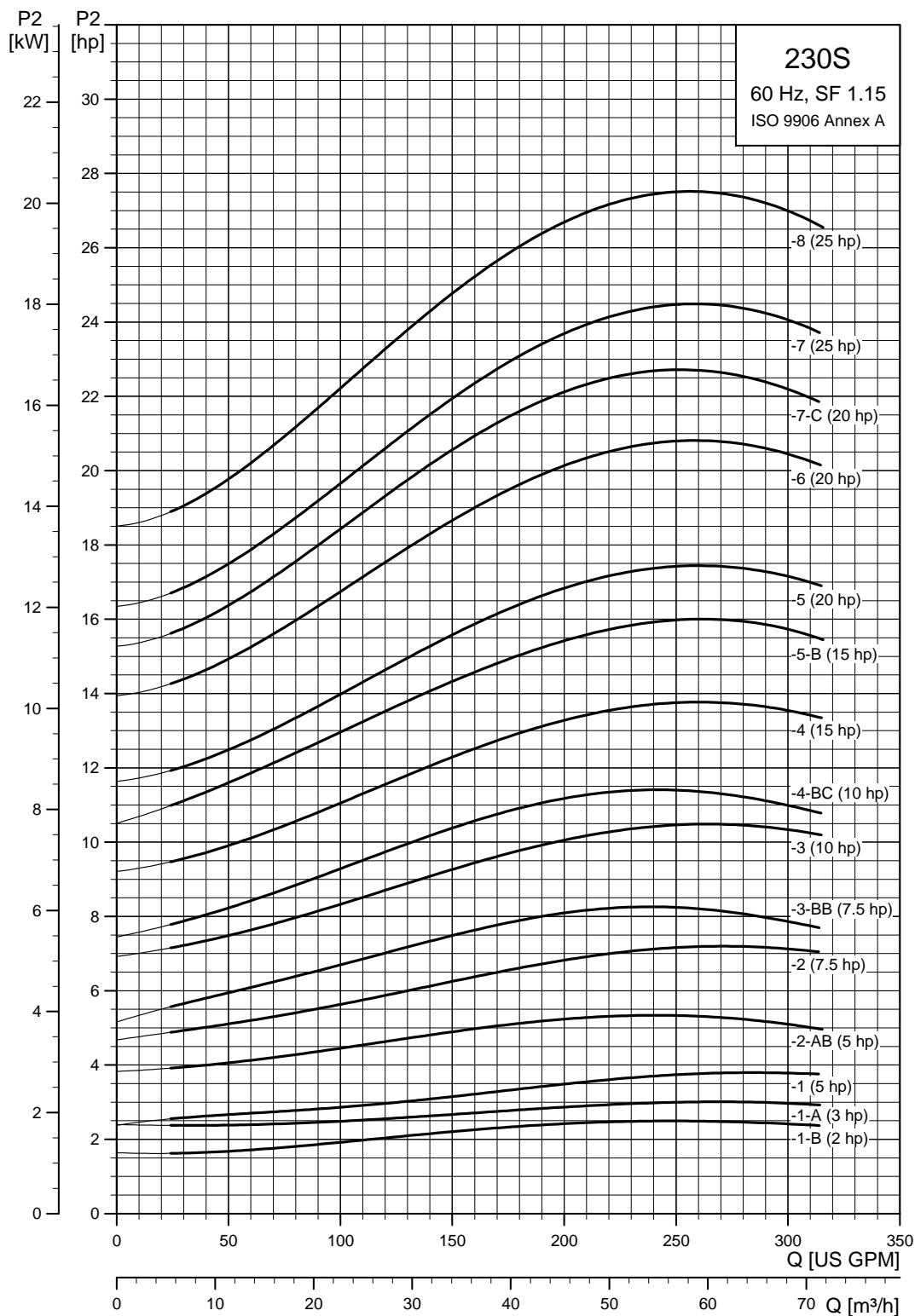

TM05 0245 1812

6" and larger wells - continued

SP 230S (230 gpm) pump power requirement (P2)

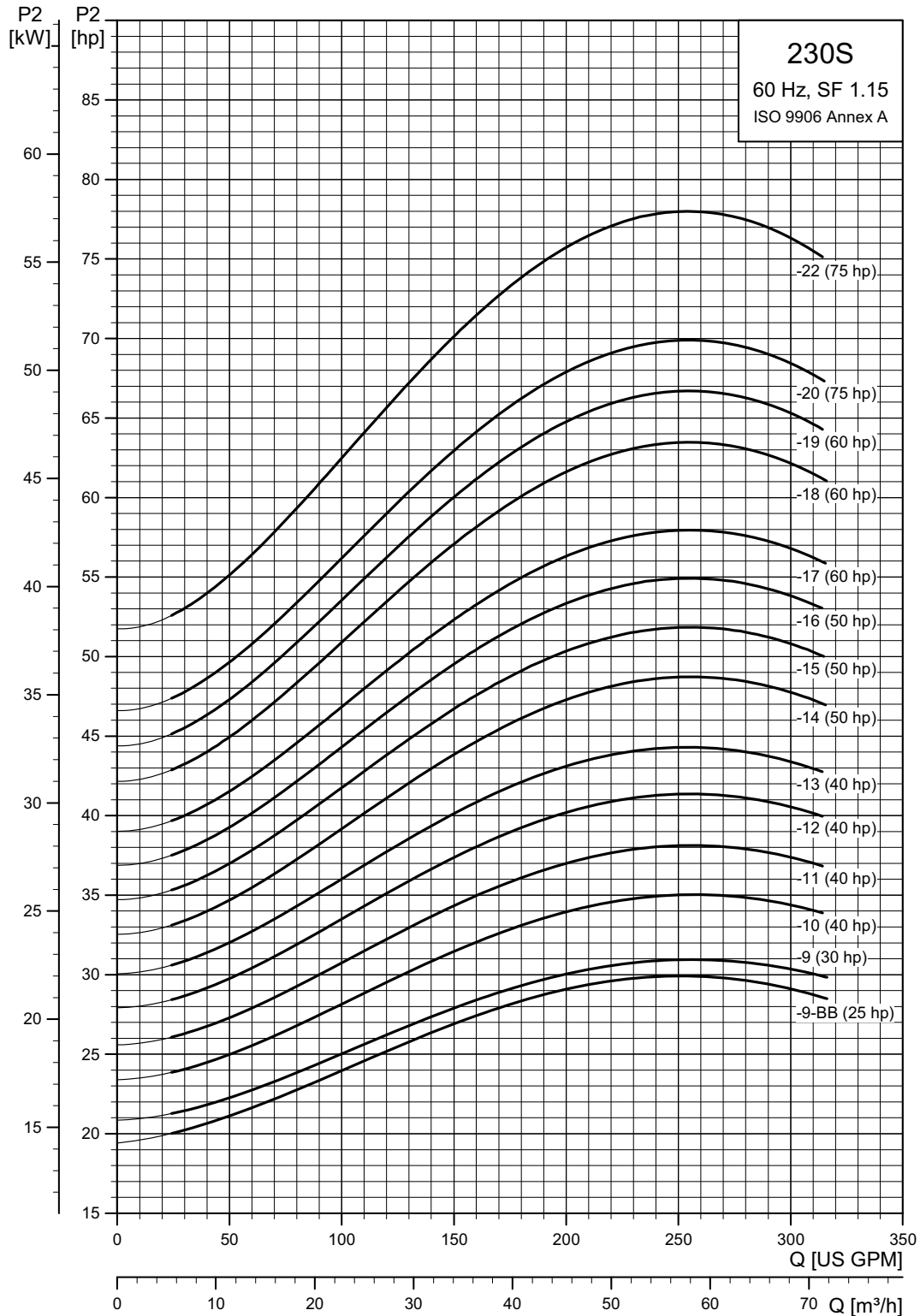

TMM05 0246 5014

6" and larger wells - continued

SP 230S (230 gpm) pump with 4", 6" motor

Pump model	Nom. head [ft]	Motor				Dimensions [in (mm)]					Net weight (complete) [lb]	
		Ph	Volts [V]	[Hp]	[rpm]	A	B	C	D	E		
230S - Motor diameter 4-inch, 3-wire motor, 60 Hz, rated flow rate 230 gpm (3" NPT)												
230S20-1B	32	1	230	2	●	3434	34.45 (875)	19.57 (497)	14.89 (378)	3.75 (95)	5.75 (146)	49.5
	32	3	230	2	■	3432	30.12 (765)	15.24 (387)	14.89 (378)	3.75 (95)	5.75 (146)	49.5
	32	3	460	2	■	3432	30.12 (765)	15.24 (387)	14.89 (378)	3.75 (95)	5.75 (146)	49.5
230S30-1A	38	1	230	3	●	3459	37.60 (955)	22.72 (577)	14.89 (378)	3.75 (95)	5.75 (146)	49.5
	38	3	230	3	●	3460	32.84 (834)	17.96 (456)	14.89 (378)	3.75 (95)	5.75 (146)	49.5
230S50-1	39	3	460	3	●	3489	32.84 (834)	17.96 (456)	14.89 (378)	3.75 (95)	5.75 (146)	49.5
	46	1	230	5	●	3516	41.54 (1055)	26.66 (677)	14.89 (378)	3.75 (95)	5.75 (146)	49.5
230S50-2AB	46	3	230	5	●	3528	37.56 (954)	22.68 (576)	14.89 (378)	3.75 (95)	5.75 (146)	49.5
	46	3	460	5	●	3527	37.56 (954)	22.68 (576)	14.89 (378)	3.75 (95)	5.75 (146)	49.5
	71	1	230	5	●	3459	45.99 (1168)	26.66 (677)	19.34 (491)	3.75 (95)	5.75 (146)	49.5
230S75-2	71	3	230	5	●	3487	42.01 (1067)	22.68 (576)	19.34 (491)	3.75 (95)	5.75 (146)	79.2
	71	3	460	5	●	3484	42.01 (1067)	22.68 (576)	19.34 (491)	3.75 (95)	5.75 (146)	79.2
230S75-3BB	86	3	230	7.5	●	3488	45.95 (1167)	26.62 (676)	19.34 (491)	3.75 (95)	5.75 (146)	79.2
	86	3	460	7.5	●	3488	45.95 (1167)	26.62 (676)	19.34 (491)	3.75 (95)	5.75 (146)	79.2
230S100-3	110	3	230	7.5	●	3468	50.40 (1280)	26.62 (676)	23.78 (604)	3.75 (95)	5.75 (146)	126.0
	110	3	460	7.5	●	3468	50.40 (1280)	26.62 (676)	23.78 (604)	3.75 (95)	5.75 (146)	126.0
230S100-3	129	3	460	10	●	3472	54.34 (1380)	30.56 (776)	23.78 (604)	3.75 (95)	5.75 (146)	126.0
230S100-4BC	141	3	460	10	●	3456	58.78 (1493)	30.56 (776)	28.23 (717)	3.75 (95)	5.75 (146)	144.9

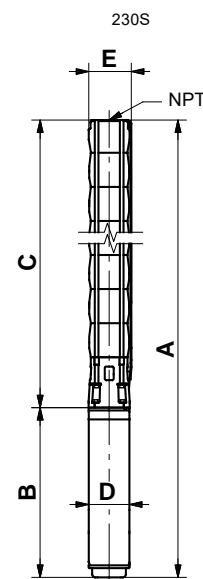

TM00 0961 1196

E = Maximum diameter of pump including cable guard and motor.

230S - Motor diameter 6 inch, 60 Hz, rated flow rate 230 gpm (3" NPT)												
-	-	3	208	5	▲	3480	-	23.51 (597)	-	5.50 (139.5)	-	80.0
			230	5	▲	3510	-	23.51 (597)	-	5.50 (139.5)	-	80.0
			460	5	▲	3500	-	23.51 (597)	-	5.50 (139.5)	-	80.0
230S75-2	87	3	230	7.5	▲	3496	43.47 (1104)	23.51 (597)	19.97 (507)	5.52 (140)	5.79 (147)	111.6
			460	7.5	▲	3505	43.47 (1104)	23.51 (597)	19.97 (507)	5.52 (140)	5.79 (147)	111.6
230S75-3BB	111	3	230	7.5	▲	3477	47.92 (1217)	23.51 (597)	24.41 (620)	5.52 (140)	5.79 (147)	131.4
			460	7.5	▲	3488	47.92 (1217)	23.51 (597)	24.41 (620)	5.52 (140)	5.79 (147)	131.4
230S100-3	129	3	230	10	▲	3474	49.10 (1247)	24.69 (627)	24.41 (620)	5.52 (140)	5.79 (147)	126.0
			460	10	▲	3486	49.10 (1247)	24.69 (627)	24.41 (620)	5.52 (140)	5.79 (147)	126.0
230S100-4BC	141	3	230	10	▲	3457	53.55 (1360)	24.69 (627)	28.86 (733)	5.52 (140)	5.79 (147)	144.9
			460	10	▲	3472	53.55 (1360)	24.69 (627)	28.86 (733)	5.52 (140)	5.79 (147)	144.9
230S150-4	176	3	230	15	▲	3491	55.91 (1420)	27.05 (687)	28.86 (733)	5.52 (140)	5.79 (147)	144.9
			460	15	▲	3495	55.91 (1420)	27.05 (687)	28.86 (733)	5.52 (140)	5.79 (147)	144.9
230S150-5B	202	3	230	15	▲	3470	60.36 (1533)	27.05 (687)	33.31 (846)	5.52 (140)	5.79 (147)	161.1
			460	15	▲	3476	60.36 (1533)	27.05 (687)	33.31 (846)	5.52 (140)	5.79 (147)	161.1
230S200-5	222	3	230	20	▲	3499	62.92 (1598)	29.61 (752)	33.31 (846)	5.52 (140)	5.79 (147)	161.1
			460	20	▲	3508	62.92 (1598)	29.61 (752)	33.31 (846)	5.52 (140)	5.79 (147)	161.1
230S200-6	248	3	230	20	▲	3476	67.37 (1711)	29.61 (752)	37.76 (959)	5.52 (140)	5.79 (147)	167.4
			460	20	▲	3488	67.37 (1711)	29.61 (752)	37.76 (959)	5.52 (140)	5.79 (147)	167.4
230S200-7C	288	3	230	20	▲	3462	71.82 (1824)	29.61 (752)	42.21 (1072)	5.52 (140)	5.79 (147)	181.8
			460	20	▲	3475	71.82 (1824)	29.61 (752)	42.21 (1072)	5.52 (140)	5.79 (147)	181.8

Notes:

Control box is required for 3-wire, single-phase applications. Data does not include control box. Performance conforms to ISO 9906: 1999 (E) Annex A. Minimum submergence is 8 ft (2.4 m).

- MS 402 motor.
- MS 4000 motor.
- ▲ MS 6000C motor.

6" and larger wells - continued

SP 230S (230 gpm) pump with 6", 8" motor

Pump model	Nom. head [ft]	Motor				Dimensions [in (mm)]					Net weight (complete) [lb]	
		Ph	Volts [V]	[Hp]	[rpm]	A	B	C	D	E		
230S - Motor diameter 6 inch, 60 Hz, rated flow rate 230 gpm (3" NPT)												
230S250-7	291	3	230	25	▲	3487	73.98 (1879)	31.78 (807)	42.21 (1072)	5.52 (140)	5.79 (147)	149.9
	294	3	460	25	▲	3497	73.98 (1879)	31.78 (807)	42.21 (1072)	5.52 (140)	5.79 (147)	181.8
230S250-8B	315	3	230	25	▲	3476	78.43 (1992)	31.78 (807)	46.66 (1185)	5.52 (140)	5.79 (147)	188.1
	316	3	460	25	▲	3487	78.43 (1992)	31.78 (807)	46.66 (1185)	5.52 (140)	5.79 (147)	188.1
230S250-8	329	3	230	25	▲	3469	78.43 (1992)	31.78 (807)	46.66 (1185)	5.52 (140)	5.79 (147)	188.1
	332	3	460	25	▲	3482	78.43 (1992)	31.78 (807)	46.66 (1185)	5.52 (140)	5.79 (147)	188.1
230S250-9BB	363	3	230	25	▲	3463	82.88 (2105)	31.78 (807)	51.11 (1298)	5.52 (140)	5.79 (147)	205.2
	366	3	460	25	▲	3476	82.88 (2105)	31.78 (807)	51.11 (1298)	5.52 (140)	5.79 (147)	205.2
230S300-9	368	3	230	30	▲	3468	85.24 (2165)	34.14 (867)	51.11 (1298)	5.52 (140)	5.79 (147)	205.2
	374	3	460	30	▲	3481	85.24 (2165)	34.14 (867)	51.11 (1298)	5.52 (140)	5.79 (147)	205.2
230S400-10	414	3	460	40	▲	3476	94.81 (2408)	39.26 (997)	55.56 (1411)	5.52 (140)	5.79 (147)	241.2
230S400-11	457	3	460	40	▲	3493	99.26 (2521)	39.26 (997)	60.00 (1524)	5.52 (140)	5.79 (147)	245.7
230S400-12	495	3	460	40	▲	3482	103.71 (2634)	39.26 (997)	64.45 (1637)	5.52 (140)	5.79 (147)	251.1
230S400-13	533	3	460	40	▲	3472	108.15 (2747)	39.26 (997)	68.90 (1750)	5.52 (140)	5.79 (147)	255.6
230S500-14	577	3	460	50	☼	3481	129.45 (3288)	56.11 (1425)	73.35 (1863)	5.67 (144)	5.79 (147)	356.0
230S500-15	615	3	460	50	☼	3471	133.90 (3401)	56.11 (1425)	77.80 (1976)	5.67 (144)	5.79 (147)	360.5
230S500-16	653	3	460	50	☼	3462	138.35 (3514)	56.11 (1425)	82.25 (2089)	5.67 (144)	5.79 (147)	365.0
230S600-17	700	3	460	60	☼	3460	142.81 (3624)	56.11 (1425)	86.70 (2202)	5.67 (144)	5.79 (147)	381.0
230S600-18	742	3	460	60	☼	3452	147.26 (3740)	56.11 (1425)	91.15 (2315)	5.67 (144)	5.79 (147)	386.0
230S600-19	783	3	460	60	☼	3444	151.71 (3853)	56.11 (1425)	95.60 (2428)	5.67 (144)	5.79 (147)	391.0
230S - Motor diameter 8 inch, 60 Hz, rated flow rate 230 gpm (3" NPT)												
230S600-17	700	3	460	60	*	3460	138.47 (3517)	50.00 (1270)	88.47 (2247)	7.56 (192)	7.56 (192)	546.0
230S600-18	741	3	460	60	*	3452	142.92 (3630)	50.00 (1270)	92.92 (2360)	7.56 (192)	7.56 (192)	568.5
230S600-19	783	3	460	60	*	3444	147.37 (3743)	50.00 (1270)	97.37 (2473)	7.56 (192)	7.56 (192)	591.0
230S750-20DS	850	3	460	75	*	3526	164.69 (4183)	53.15 (1350)	111.54 (2833)	7.56 (192)	7.56 (192)	549.9
230S750-22DS	931	3	460	75	*	3519	173.59 (4409)	53.15 (1350)	120.44 (3059)	7.56 (192)	7.56 (192)	620.4

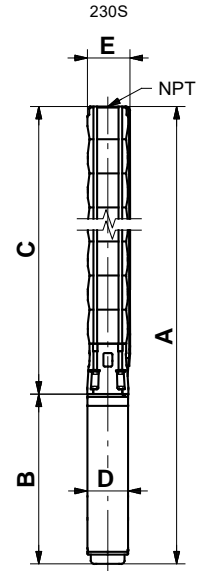

TM00 0961 1196

E = Maximum diameter of pump including cable guard and motor.

Notes:

Control box is required for 3-wire, single-phase applications. Data does not include control box.

DS designation = Built into sleeve, 3" NPT, 8" minimum well diameter.

Performance conforms to ISO 9906. 1999 (E) Annex A. Minimum submergence is 8 ft (2.4 m).

- ▲ MS 6000C motor.
- ☼ Takes MMS 6 motor; not available as complete.
- * Takes MMS 8000 motor; not available as complete.

6" and larger wells - continued

SP 300S (300 gpm)

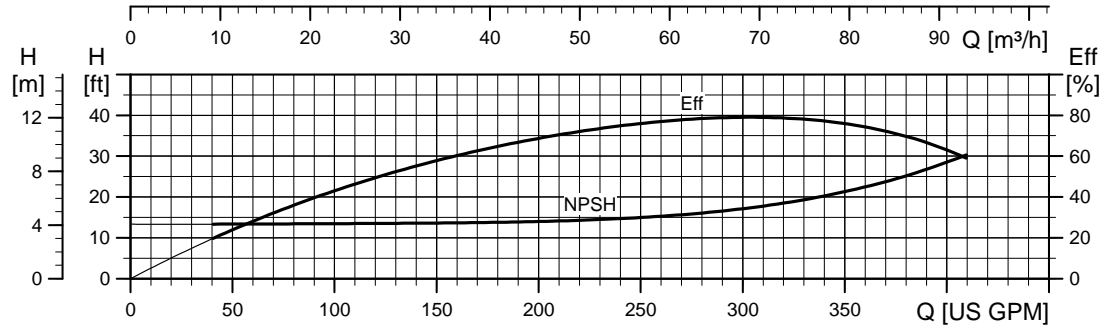
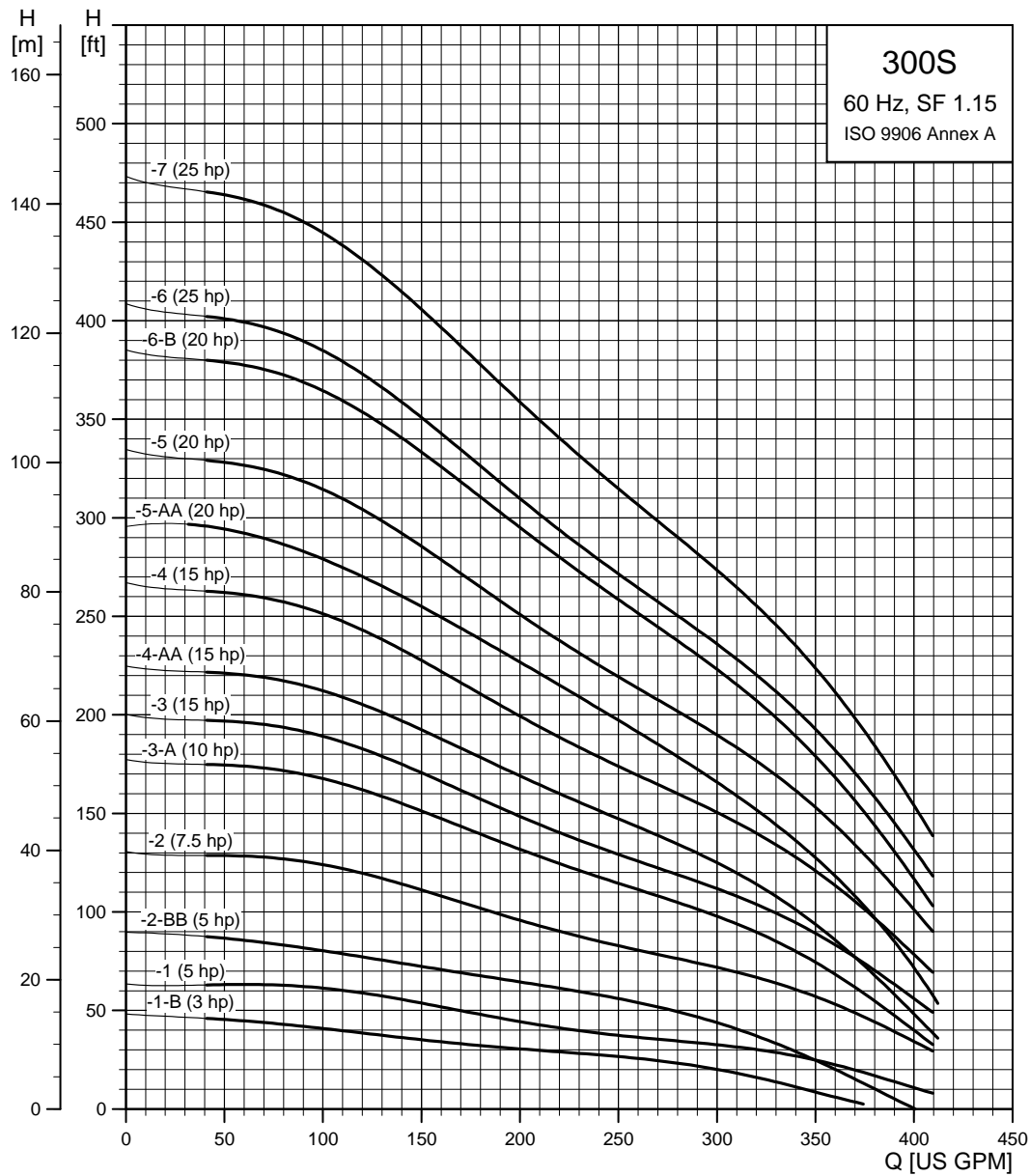

TM05 0247 1812

6" and larger wells - continued

SP 300S (300 gpm)

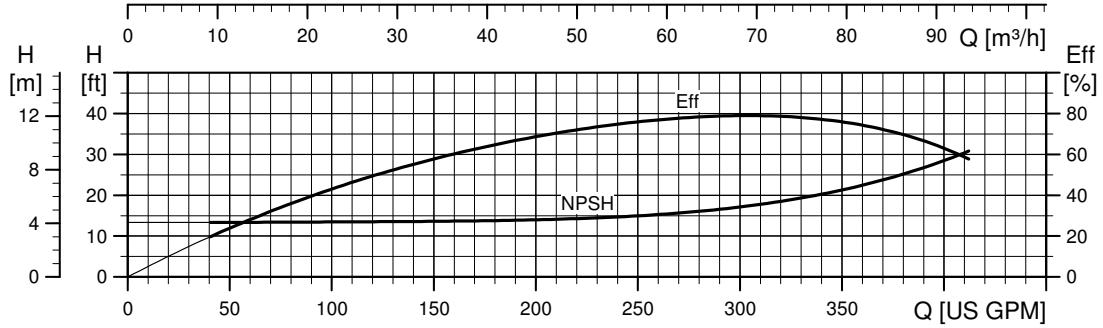
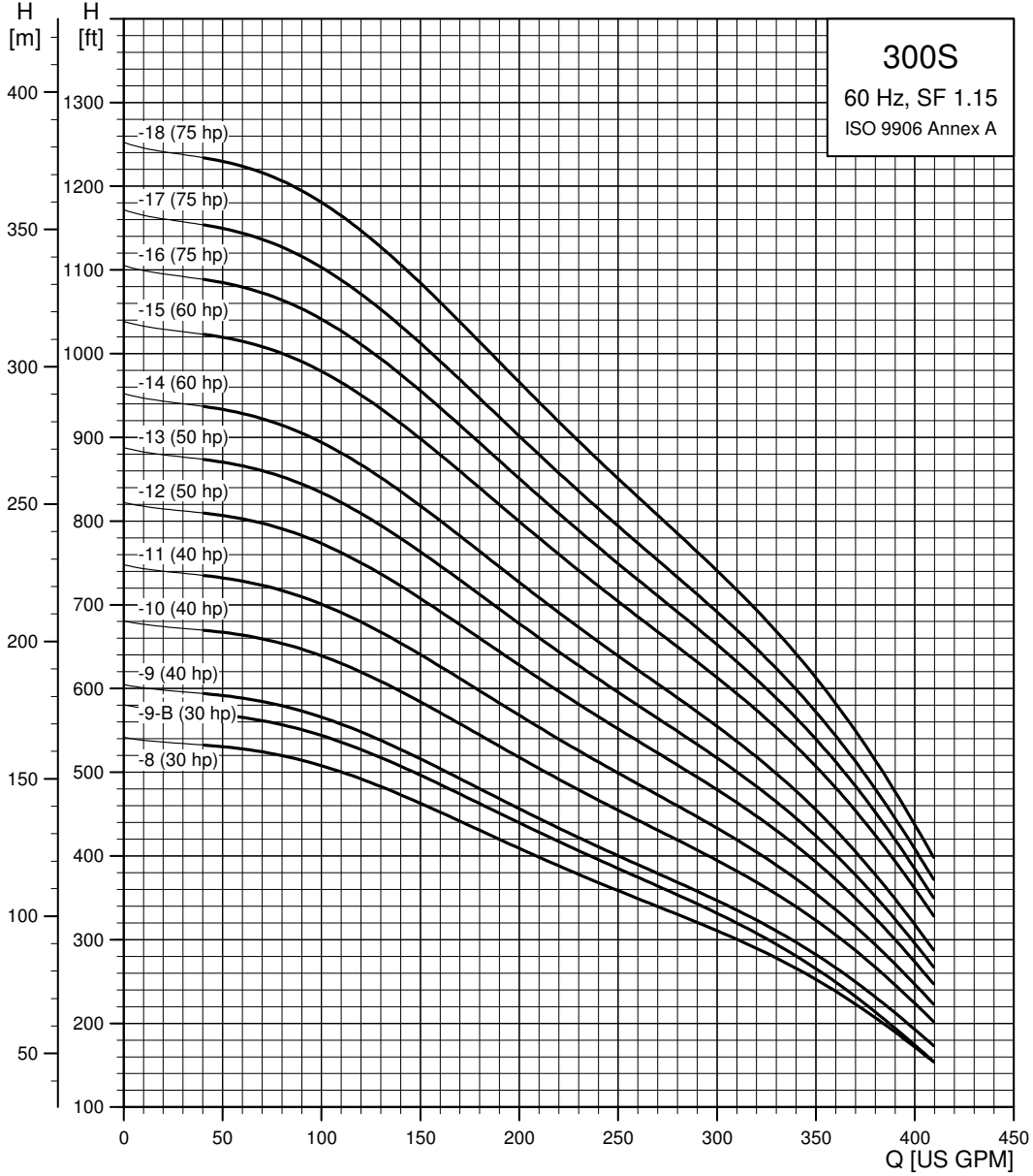

TM05 0248 5014

6" and larger wells - continued

SP 300S (300 gpm) pump power requirement (P2)

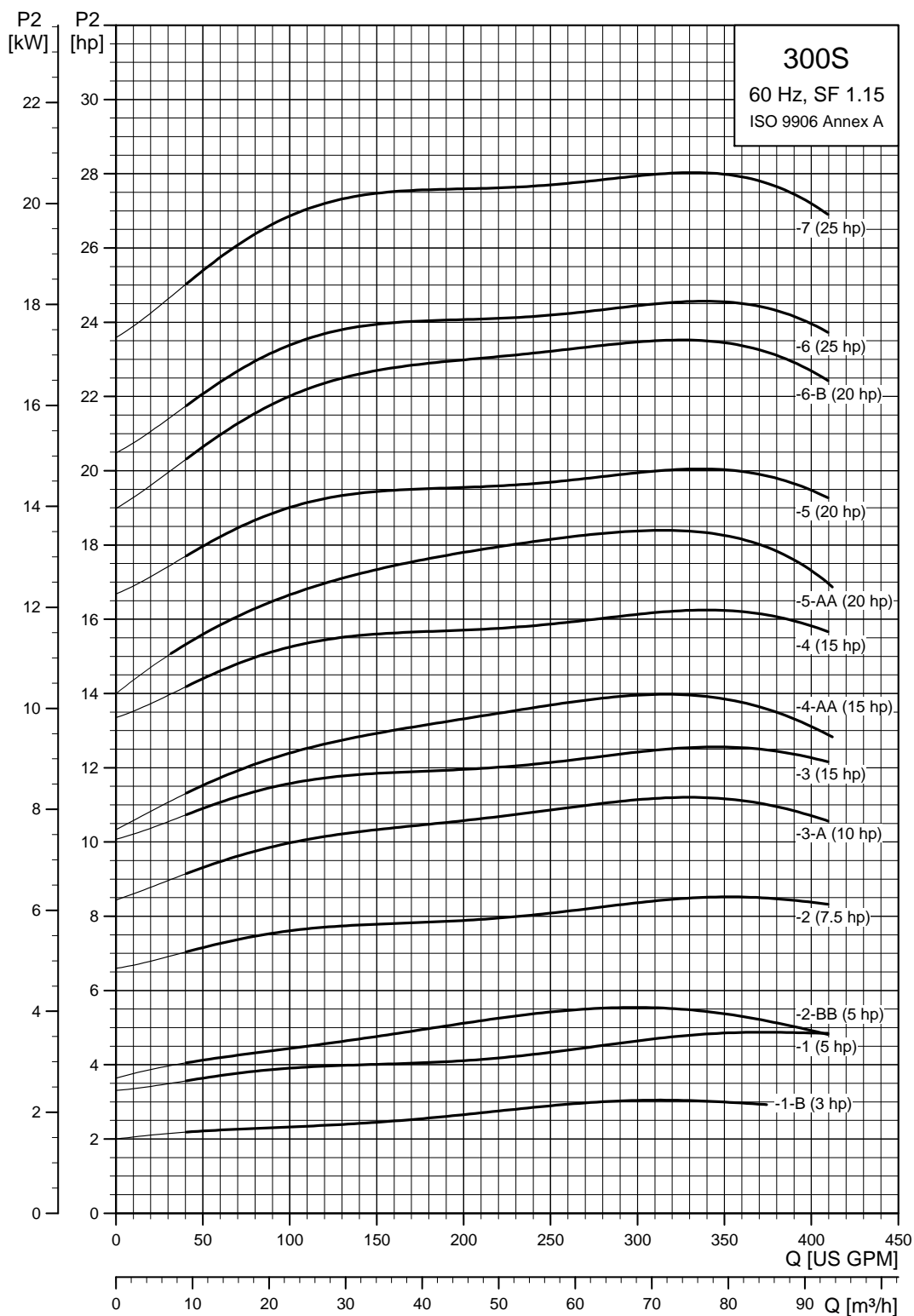

TM05 0249 1812

6" and larger wells - continued

SP 300S (300 gpm) pump power requirement (P2)

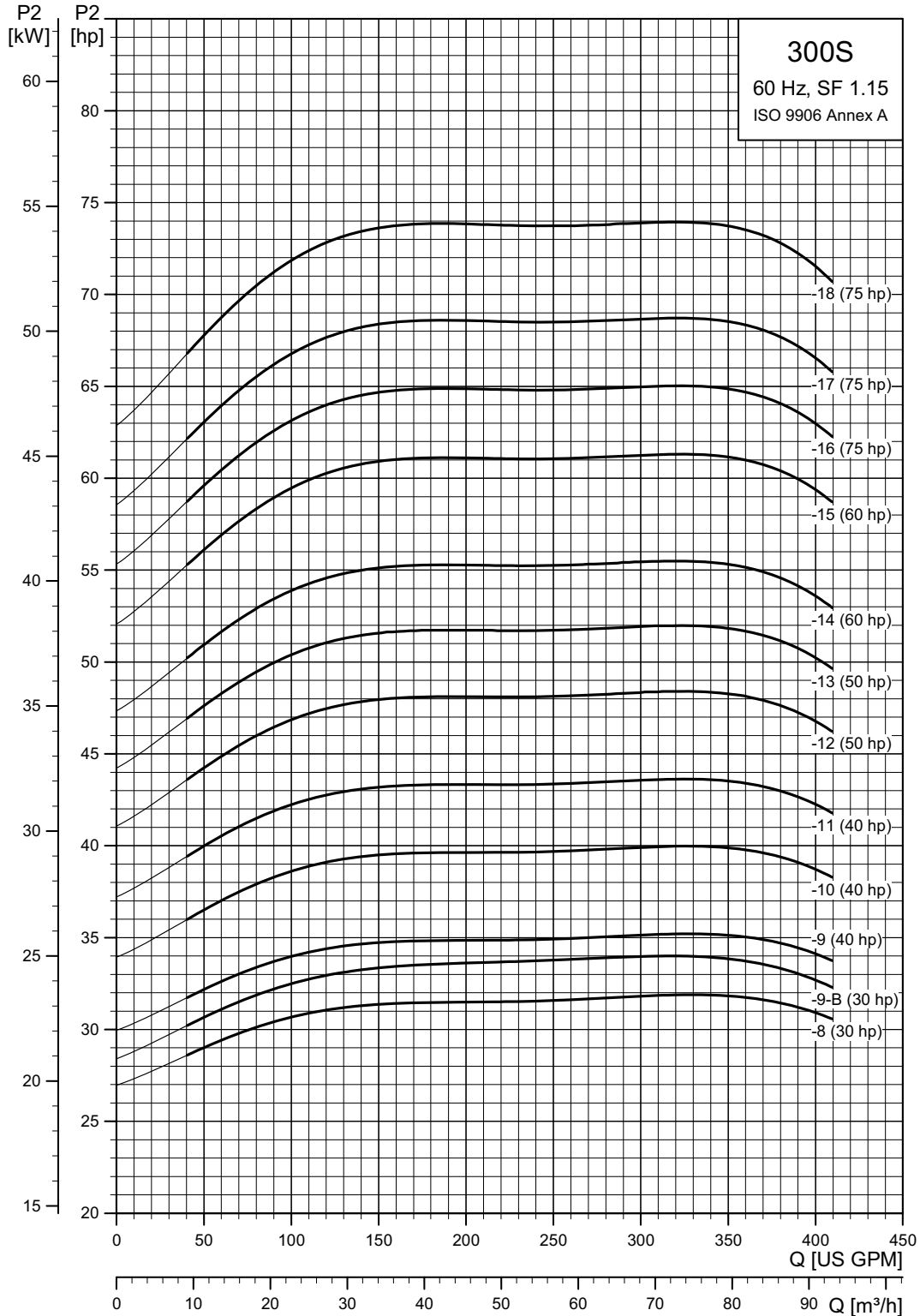

TM05 0250 5014

6" and larger wells - continued

SP 300S (300 gpm) pump with 4", 6" motor

Pump model	Nom. head [ft]	Ph	Motor			Dimensions [in (mm)]					Net weight (complete) [lb]	
			Volts [V]	[Hp]	[rpm]	A	B	C	D	E		
300S - Motor diameter 4-inch, 3-wire motor, 60 Hz, rated flow rate 300 gpm (3" NPT)												
300S30-1B	29	1	230	3	●	3470	37.60 (955)	22.72 (577)	14.89 (378)	3.75 (95)	5.75 (146)	72.0
	30	3	230	3	●	3466	32.84 (834)	17.96 (456)	14.89 (378)	3.75 (95)	5.75 (146)	72.0
	30	3	460	3	●	3494	32.84 (834)	17.96 (456)	14.89 (378)	3.75 (95)	5.75 (146)	72.0
300S50-1	38	1	230	5	●	3490	41.54 (1055)	26.66 (677)	14.89 (378)	3.75 (95)	5.75 (146)	74.7
	38	3	230	5	●	3508	37.56 (954)	22.68 (576)	14.89 (378)	3.75 (95)	5.75 (146)	74.7
	38	3	460	5	●	3506	37.56 (954)	22.68 (576)	14.89 (378)	3.75 (95)	5.75 (146)	74.7
300S50-2BB	57	1	230	5	●	3443	45.99 (1168)	26.66 (677)	19.34 (491)	3.75 (95)	5.75 (146)	135.0
	57	3	230	5	●	3480	42.01 (1067)	22.68 (576)	19.34 (491)	3.75 (95)	5.75 (146)	135.0
	57	3	460	5	●	3477	42.01 (1067)	22.68 (576)	19.34 (491)	3.75 (95)	5.75 (146)	135.0
300S75-2	77	3	230	7.5	●	3463	45.95 (1167)	26.62 (676)	19.34 (491)	3.75 (95)	5.75 (146)	101.7
	77	3	460	7.5	●	3463	45.95 (1167)	26.62 (676)	19.34 (491)	3.75 (95)	5.75 (146)	101.7
300S100-3A	107	3	460	10	●	3461	54.34 (1380)	30.56 (776)	23.78 (604)	3.75 (95)	5.75 (146)	145.8
300S - Motor diameter 6 inch, 60 Hz, rated flow rate 300 gpm (3" NPT)												
-	-	3	208	5	▲	3480	-	23.51 (597)	-	5.50 (139.5)	-	80.0
			230	5	▲	3510	-	23.51 (597)	-	5.50 (139.5)	-	80.0
			460	5	▲	3500	-	23.51 (597)	-	5.50 (139.5)	-	80.0
300S75-2	77	3	230	7.5	▲	3472	43.47 (1104)	23.51 (597)	19.97 (507)	5.52 (140)	5.79 (147)	167.4
	78	3	460	7.5	▲	3484	43.47 (1104)	23.51 (597)	19.97 (507)	5.52 (140)	5.79 (147)	167.4
300S100-3A	107	3	230	10	▲	3461	49.10 (1247)	24.69 (627)	24.41 (620)	5.52 (140)	5.79 (147)	216.0
	107	3	460	10	▲	3475	49.10 (1247)	24.69 (627)	24.41 (620)	5.52 (140)	5.79 (147)	216.0
300S150-3	119	3	230	15	▲	3503	51.46 (1307)	27.05 (687)	24.41 (620)	5.52 (140)	5.79 (147)	216.0
	119	3	460	15	▲	3506	51.46 (1307)	27.05 (687)	24.41 (620)	5.52 (140)	5.79 (147)	216.0
300S150-4AA	138	3	230	15	▲	3488	55.91 (1420)	27.05 (687)	28.86 (733)	5.52 (140)	5.79 (147)	222.3
	139	3	460	15	▲	3492	55.91 (1420)	27.05 (687)	28.86 (733)	5.52 (140)	5.79 (147)	222.3
300S150-4	157	3	230	15	▲	3469	55.91 (1420)	27.05 (687)	28.86 (733)	5.52 (140)	5.79 (147)	222.3
	158	3	460	15	▲	3474	55.91 (1420)	27.05 (687)	28.86 (733)	5.52 (140)	5.79 (147)	222.3
300S200-5AA	179	3	230	20	▲	3493	62.92 (1598)	29.61 (752)	33.31 (846)	5.52 (140)	5.79 (147)	194.4
	180	3	460	20	▲	3503	62.92 (1598)	29.61 (752)	33.31 (846)	5.52 (140)	5.79 (147)	194.4
300S200-5	200	3	230	20	▲	3479	62.92 (1598)	29.61 (752)	33.31 (846)	5.52 (140)	5.79 (147)	194.4
	201	3	460	20	▲	3491	62.92 (1598)	29.61 (752)	33.31 (846)	5.52 (140)	5.79 (147)	194.4
300S200-6B	222	3	230	20	▲	3462	67.37 (1711)	29.61 (752)	37.76 (959)	5.52 (140)	5.79 (147)	198.0
	224	3	460	20	▲	3476	67.37 (1711)	29.61 (752)	37.76 (959)	5.52 (140)	5.79 (147)	198.0
300S250-6	243	3	230	25	▲	3487	69.53 (1766)	31.78 (807)	37.76 (959)	5.52 (140)	5.79 (147)	198.0
	244	3	460	25	▲	3497	69.53 (1766)	31.78 (807)	37.76 (959)	5.52 (140)	5.79 (147)	198.0

Notes:

Performance conforms to ISO 9906: 1999 (E) Annex A. Minimum submergence is 8 ft (2.4 m).

- MS 4000 motor.
- ▲ MS 6000C motor.

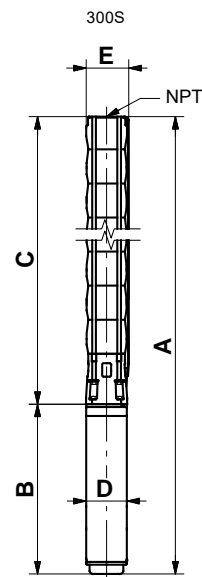

TM00 0961 1196

E = Maximum diameter of pump including cable guard and motor.

6" and larger wells - continued

SP 300S (300 gpm) pump with 6", 8" motor

Pump model	Nom. head [ft]	Ph	Motor			Dimensions [in (mm)]					Net weight (complete) [lb]	
			Volts [V]	[Hp]	[rpm]	A	B	C	D	E		
300S - Motor diameter 6 inch, 60 Hz, rated flow rate 300 gpm (4" NPT)												
300S250-7AA	260	3	230	25	▲	3478	73.98 (1879)	31.78 (807)	42.21 (1072)	5.52 (140)	5.79 (147)	217.8
	262	3	460	25	▲	3489	73.98 (1879)	31.78 (807)	42.21 (1072)	5.52 (140)	5.79 (147)	217.8
300S300-7	283	3	230	30	▲	3482	76.34 (1939)	34.14 (867)	42.21 (1072)	5.52 (140)	5.79 (147)	217.8
	285	3	460	30	▲	3493	76.34 (1939)	34.14 (867)	42.21 (1072)	5.52 (140)	5.79 (147)	217.8
300S300-8	321	3	230	30	▲	3463	80.79 (2052)	34.14 (867)	46.66 (1185)	5.52 (140)	5.79 (147)	224.1
	324	3	460	30	▲	3477	80.79 (2052)	34.14 (867)	46.66 (1185)	5.52 (140)	5.79 (147)	224.1
300S300-9B	343	3	230	30	▲	3450	85.24 (2165)	34.14 (867)	51.11 (1298)	5.52 (140)	5.79 (147)	261.0
	346	3	460	30	▲	3466	85.24 (2165)	34.14 (867)	51.11 (1298)	5.52 (140)	5.79 (147)	261.0
300S400-9	370	3	460	40	▲	3499	90.36 (2295)	39.26 (997)	51.11 (1298)	5.52 (140)	5.79 (147)	296.0
300S400-10	409	3	460	40	▲	3487	94.81 (2408)	39.26 (997)	55.56 (1411)	5.52 (140)	5.79 (147)	300.5
300S400-11	442	3	460	40	☼	3443	99.26 (2521)	39.26 (997)	60.00 (1524)	5.52 (140)	5.79 (147)	352.0
300S500-12	491	3	460	50	☼	3482	120.56 (3062)	56.11 (1425)	64.45 (1637)	5.67 (144)	5.79 (147)	348.8
300S500-13	529	3	460	50	☼	3471	125.00 (3175)	56.11 (1425)	68.90 (1750)	5.67 (144)	5.79 (147)	355.1
300S600-14	594	3	460	60	☼	3456	129.46 (3288)	56.11 (1425)	73.35 (1863)	5.67 (144)	5.79 (147)	371.0
300S600-15	606	3	460	60	☼	3458	133.91 (3401)	56.11 (1425)	77.80 (1976)	5.67 (144)	5.79 (147)	378.0
SP 300S - Motor diameter 8 inch, 60 Hz, rated flow rate 230 gpm (4" NPT)												
300S600-14	594	3	460	60	*	3456	125.12 (3178)	50.00 (1270)	75.12 (1908)	7.56 (192)	7.56 (192)	479.4
300S600-15	629	3	460	60	*	3515	129.57 (3291)	50.00 (1270)	79.57 (2021)	7.56 (192)	7.56 (192)	519.4
300S750-16	678	3	460	75	*	3532	137.17 (3484)	53.15 (1350)	84.02 (2134)	7.56 (192)	7.56 (192)	569.1
300S750-17	719	3	460	75	*	3528	141.62 (3597)	53.15 (1350)	88.47 (2247)	7.56 (192)	7.56 (192)	575.4
300S750-18	760	3	460	75	*	3523	146.07 (3710)	53.15 (1350)	92.92 (2360)	7.56 (192)	7.56 (192)	581.7

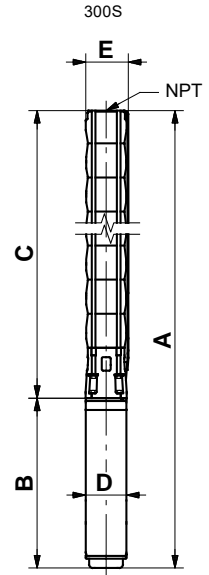

TM00 0961 1196

E = Maximum diameter of pump including cable guard and motor.

Notes:

Performance conforms to ISO 9906 Annex A. Minimum submergence is 8 ft (2.4 m).

- ▲ MS 6000C motor.
- ☼ Takes MMS 6 motor; not available as complete.
- * Takes MMS 8000 motor; not available as complete.

8" and larger wells

SP 385S (385 gpm)

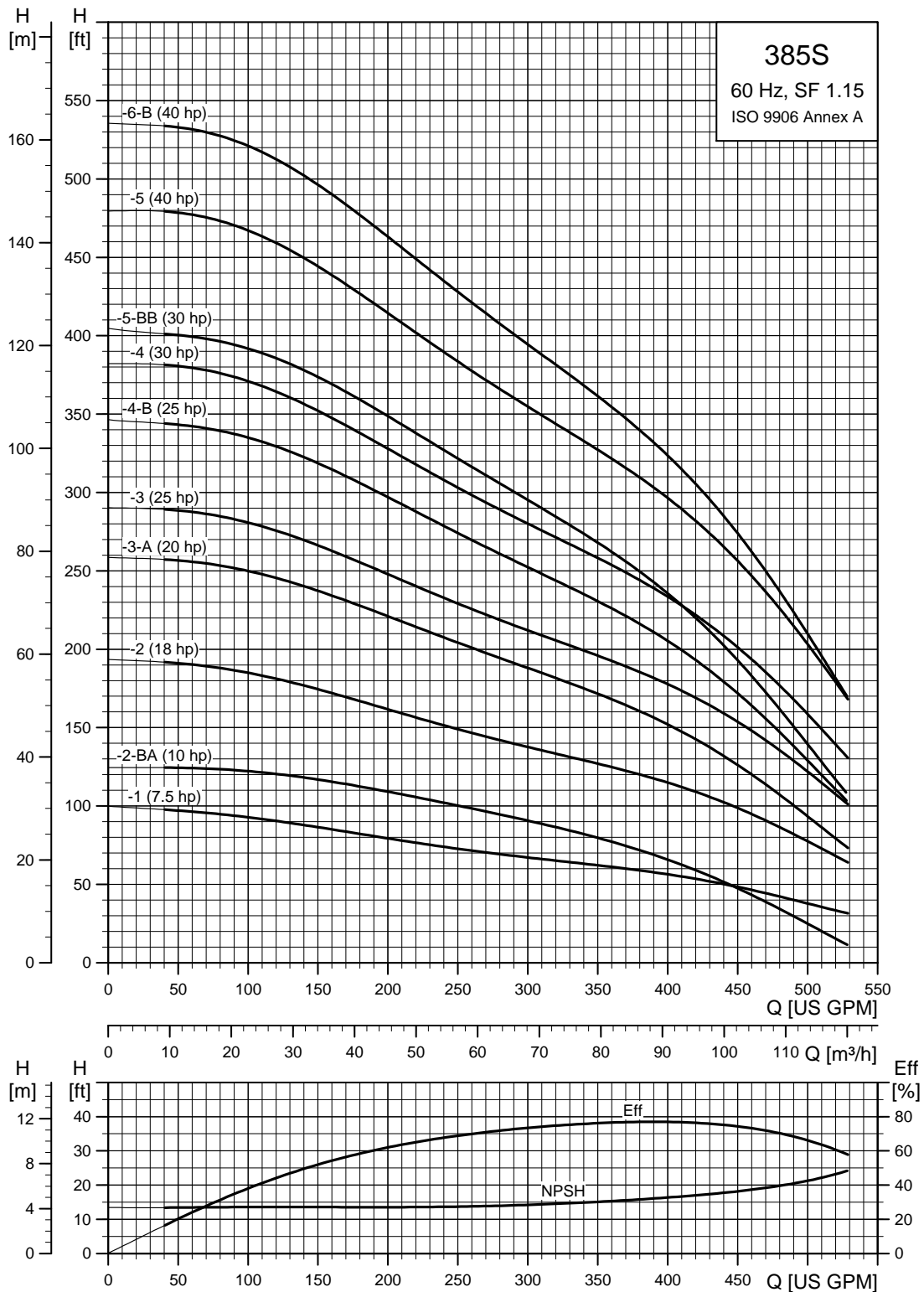

TM05 0251 1812

8" and larger wells - continued

SP 385S (385 gpm)

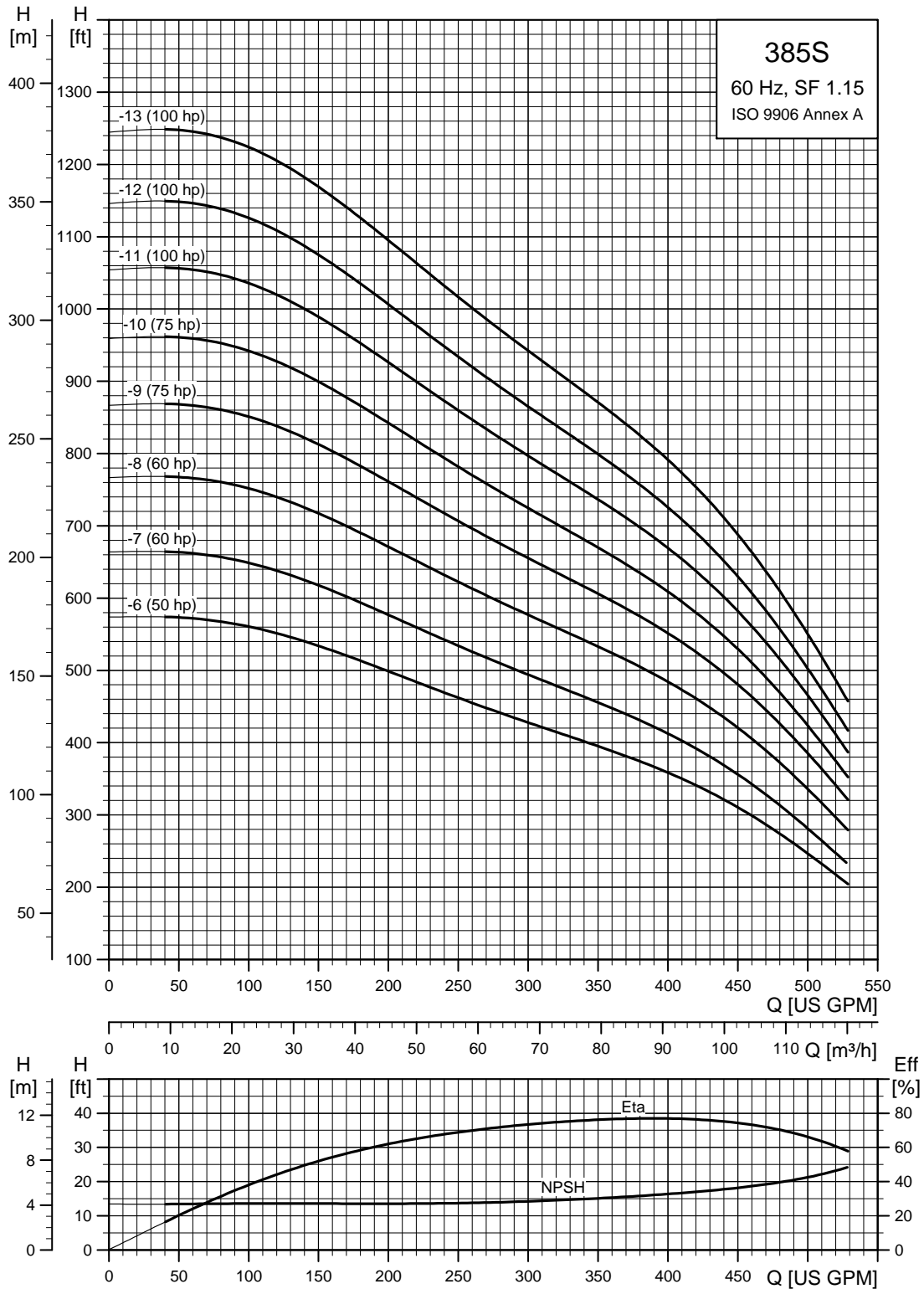

TM05 0252 1812

8" and larger wells - continued

SP 385S (385 gpm) pump power requirement (P2)

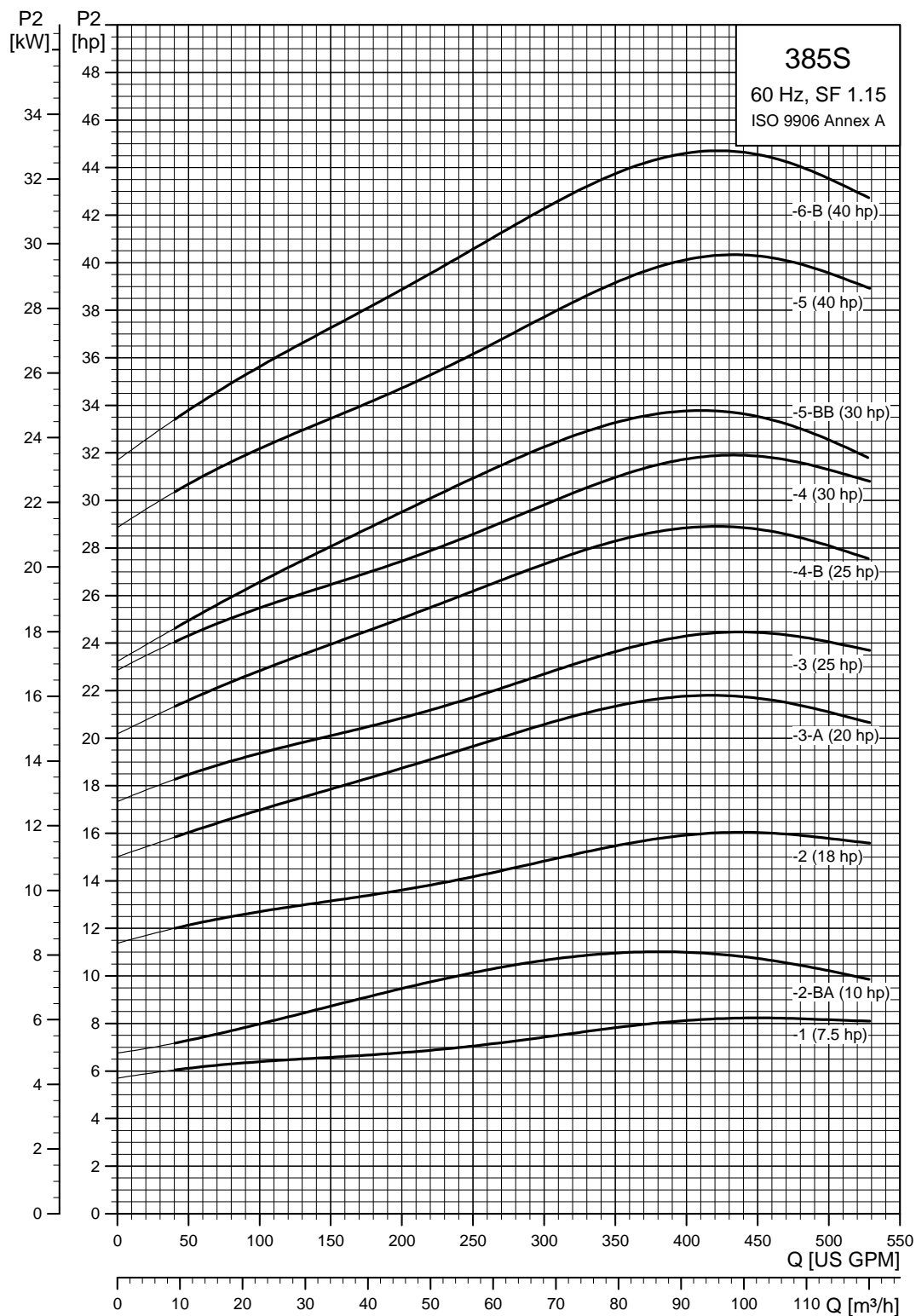

TM05 0253 1812

8" and larger wells - continued

SP 385S (385 gpm) pump power requirement (P2)

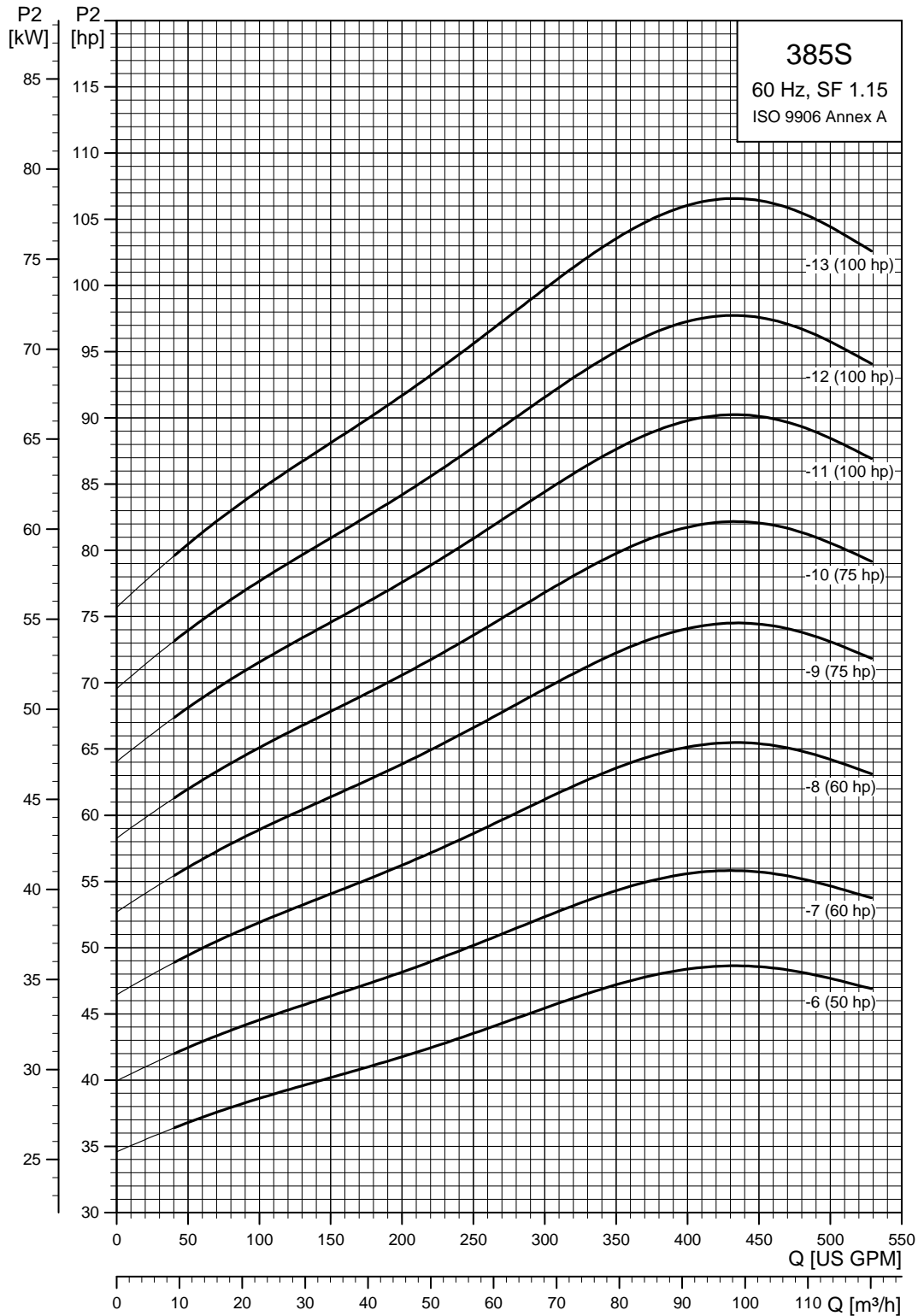

TM05 0254 1812

8" and larger wells - continued

SP 385S (385 gpm) pump with 6", 8", 10" motor

Pump model	Nom. head [ft]	Ph	Motor			Dimensions [in (mm)]					Net weight (complete) [lb]	
			Volts [V]	[Hp]	[rpm]	A	B	C	D	E		
385S - Motor diameter 6 inch, 60 Hz, rated flow rate 385 gpm (4" NPT)												
-	-	3	208	5	▲	3480	-	23.51 (597)	-	5.50 (139.5)	-	80.0
-	-	3	230	5	▲	3510	-	23.51 (597)	-	5.50 (139.5)	-	80.0
-	-	3	460	5	▲	3500	-	23.51 (597)	-	5.50 (139.5)	-	80.0
385S75-1	60	3	230	7.5	▲	3478	46.58 (1183)	22.25 (565)	24.34 (618)	5.63 (143)	7.01 (178)	135.9
	61	3	460	7.5	▲	3489	46.58 (1183)	22.25 (565)	24.34 (618)	5.63 (143)	7.01 (178)	135.9
385S100-2AB	87	3	230	10	▲	3467	52.6 (1336)	23.23 (590)	29.38 (746)	5.63 (143)	7.01 (178)	169.2
	87	3	460	10	▲	3482	52.6 (1336)	23.23 (590)	29.38 (746)	5.63 (143)	7.01 (178)	169.2
385S150-2	123	3	230	15	▲	3472	57.25 (1454)	27.88 (708)	29.38 (746)	5.63 (143)	7.01 (178)	169.2
	123	3	460	15	▲	3477	57.25 (1454)	27.88 (708)	29.38 (746)	5.63 (143)	7.01 (178)	169.2
385S200-3A	163	3	230	20	▲	3469	65.24 (1657)	30.83 (783)	34.41 (874)	5.63 (143)	7.01 (178)	188.1
	165	3	460	20	▲	3482	65.24 (1657)	30.83 (783)	34.41 (874)	5.63 (143)	7.01 (178)	188.1
385S250-3	187	3	230	25	▲	3489	67.41 (1712)	33.00 (838)	34.41 (874)	5.63 (143)	7.01 (178)	188.1
	189	3	460	25	▲	3499	67.41 (1712)	33.00 (838)	34.41 (874)	5.63 (143)	7.01 (178)	188.1
385S250-4B	220	3	230	25	▲	3461	72.45 (1840)	33.00 (838)	39.45 (1002)	5.63 (143)	7.01 (178)	239.4
	222	3	460	25	▲	3475	72.45 (1840)	33.00 (838)	39.45 (1002)	5.63 (143)	7.01 (178)	239.4
385S300-4	234	3	230	30	▲	3463	75.00 (1905)	35.56 (903)	39.45 (1002)	5.63 (143)	7.01 (178)	239.4
	249	3	460	30	▲	3478	75.00 (1905)	35.56 (903)	39.45 (1002)	5.63 (143)	7.01 (178)	239.4
385S300-5BB	254	3	230	30	▲	3452	80.04 (2033)	35.56 (903)	44.49 (1130)	5.63 (143)	7.01 (178)	247.5
	257	3	460	30	▲	3467	80.04 (2033)	35.56 (903)	44.49 (1130)	5.63 (143)	7.01 (178)	247.5
385S400-5	314	3	460	40	▲	3488	84.77 (2153)	40.28 (1023)	44.49 (1130)	5.63 (143)	7.01 (178)	247.5
385S400-6B	347	3	460	40	▲	3471	89.81 (2281)	40.28 (1023)	49.53 (1258)	5.63 (143)	7.01 (178)	252.0
385S500-6	375	3	460	50	☼	3447	110.99 (2825)	56.11 (1425)	54.88 (1394)	5.67 (144)	7.88 (200)	376.0
385S500-7A	414	3	460	50	☼	3467	110.99 (2825)	56.11 (1425)	54.88 (1394)	5.67 (144)	7.88 (200)	407.0
385S600-7	449	3	460	60	☼	3414	111.23 (2825)	56.11 (1425)	55.12 (1400)	5.67 (144)	7.88 (200)	385.0
385S600-8	494	3	460	60	☼	3449	111.23 (2825)	56.11 (1425)	55.12 (1400)	5.67 (144)	7.88 (200)	385.0

385S - Motor diameter 8 inch, 60 Hz, rated flow rate 385 gpm (4" NPT)												
385S400-6B	351	3	460	40	*	3490	93.78 (2382)	43.71 (1110)	50.08 (1272)	7.56 (192)	7.88 (200)	428.3
385S500-6	375	3	460	50	*	3481	95.75 (2432)	45.67 (1160)	50.08 (1272)	7.56 (192)	7.88 (200)	451.2
385S500-7A	420	3	460	50	*	3492	100.79 (2560)	45.67 (1160)	55.12 (1400)	7.56 (192)	7.88 (200)	461.1
385S600-7	449	3	460	60	*	3459	105.12 (2670)	50.00 (1270)	55.12 (1400)	7.56 (192)	7.88 (200)	507.3
385S600-8	511	3	460	60	*	3510	110.16 (2798)	50.00 (1270)	60.16 (1528)	7.56 (192)	7.88 (200)	517.2
385S750-9	582	3	460	75	*	3508	118.35 (3006)	53.15 (1350)	65.2 (1656)	7.56 (192)	7.88 (200)	558.7
385S750-10	643	3	460	75	*	3498	123.39 (3134)	53.15 (1350)	70.24 (1784)	7.56 (192)	7.88 (200)	568.6
385S1000-11	711	3	460	100	*	3512	137.88 (3502)	62.60 (1590)	75.28 (1912)	7.56 (192)	7.88 (200)	677.5
385S1000-12	771	3	460	100	*	3505	142.92 (3630)	62.60 (1590)	80.32 (2040)	7.56 (192)	7.88 (200)	687.4
385S1000-13	831	3	460	100	*	3497	147.96 (3758)	62.60 (1590)	85.36 (2168)	7.56 (192)	7.88 (200)	697.3

Notes:

Performance conforms to ISO 9906 Annex A. Minimum submergence is 8 ft (2.4 m).

▲ MS 6000C motor.

☼ Takes MMS 6 motor; not available as complete.

* Takes MMS 8000 motor; not available as complete.

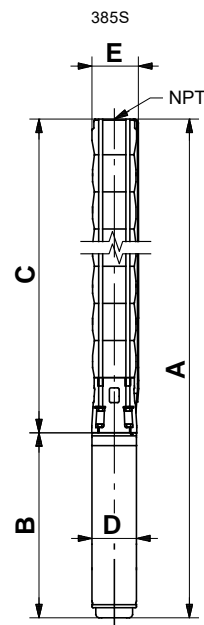

TM00 7872 2196

E = Maximum diameter of pump including cable guard and motor.

8" and larger wells - continued

SP 475S (475 gpm)

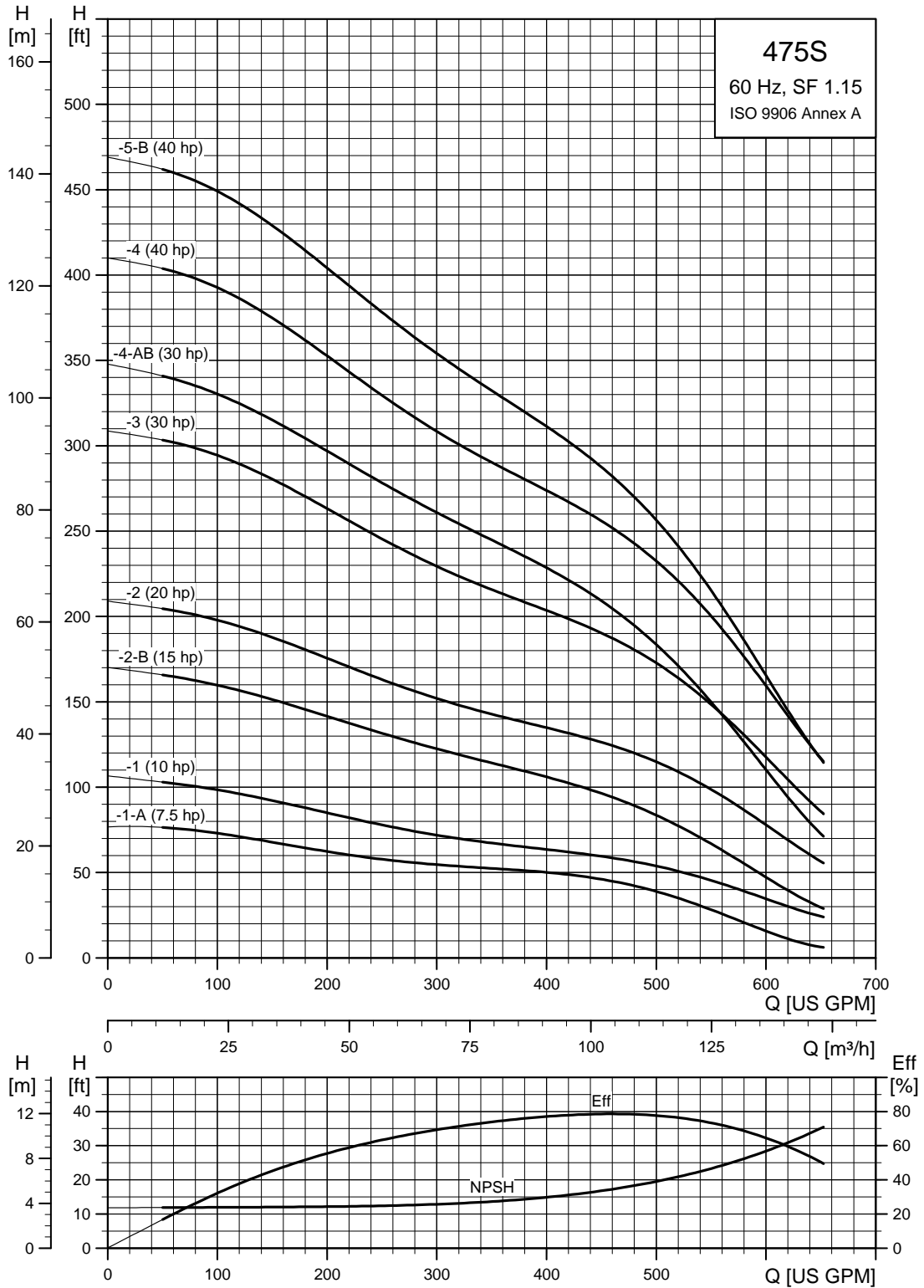

TM05 0255 2112

8" and larger wells - continued

SP 475S (475 gpm)

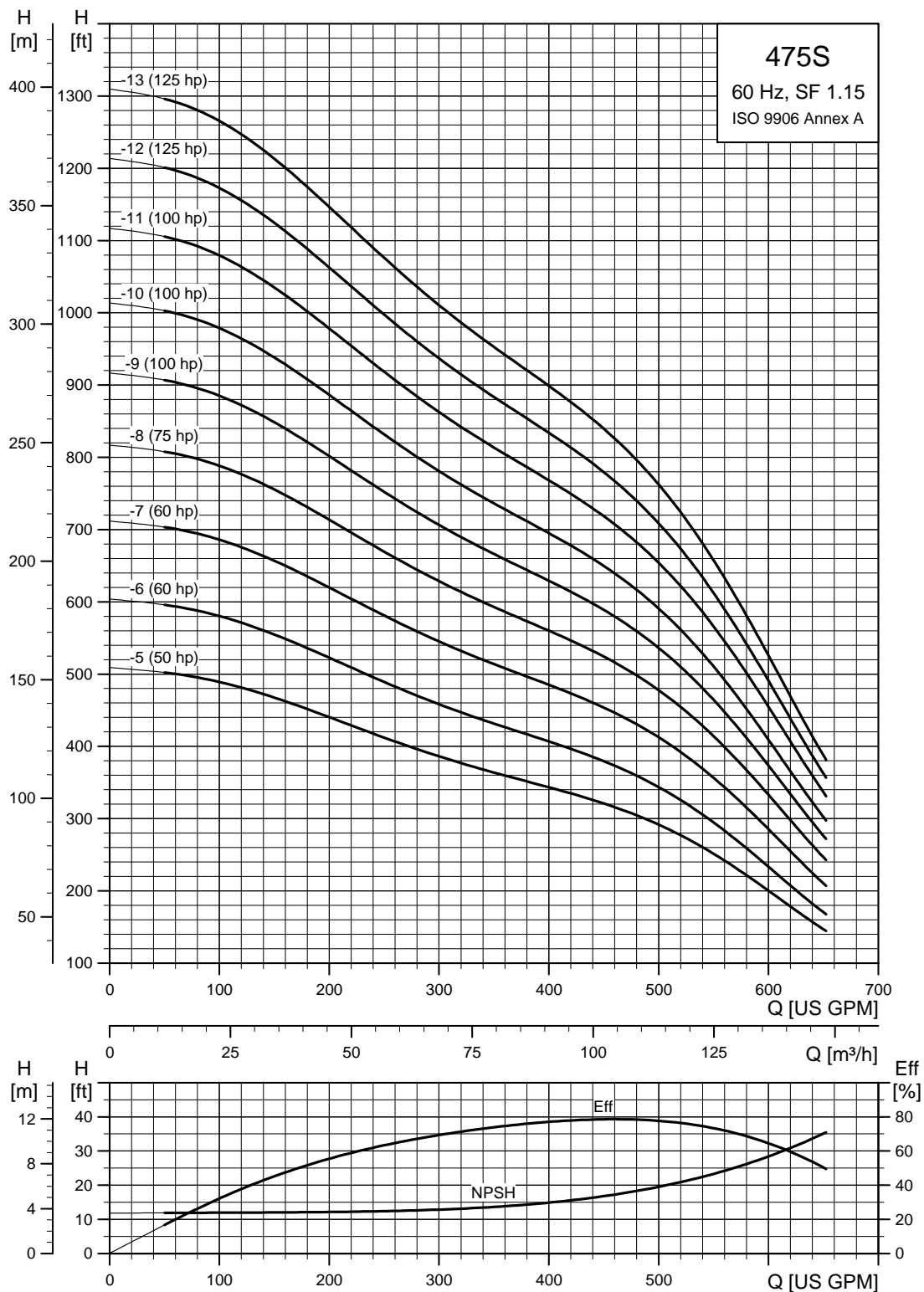

TM05 0256 2112

8" and larger wells - continued

SP 475S (475 gpm) pump power requirement (P2)

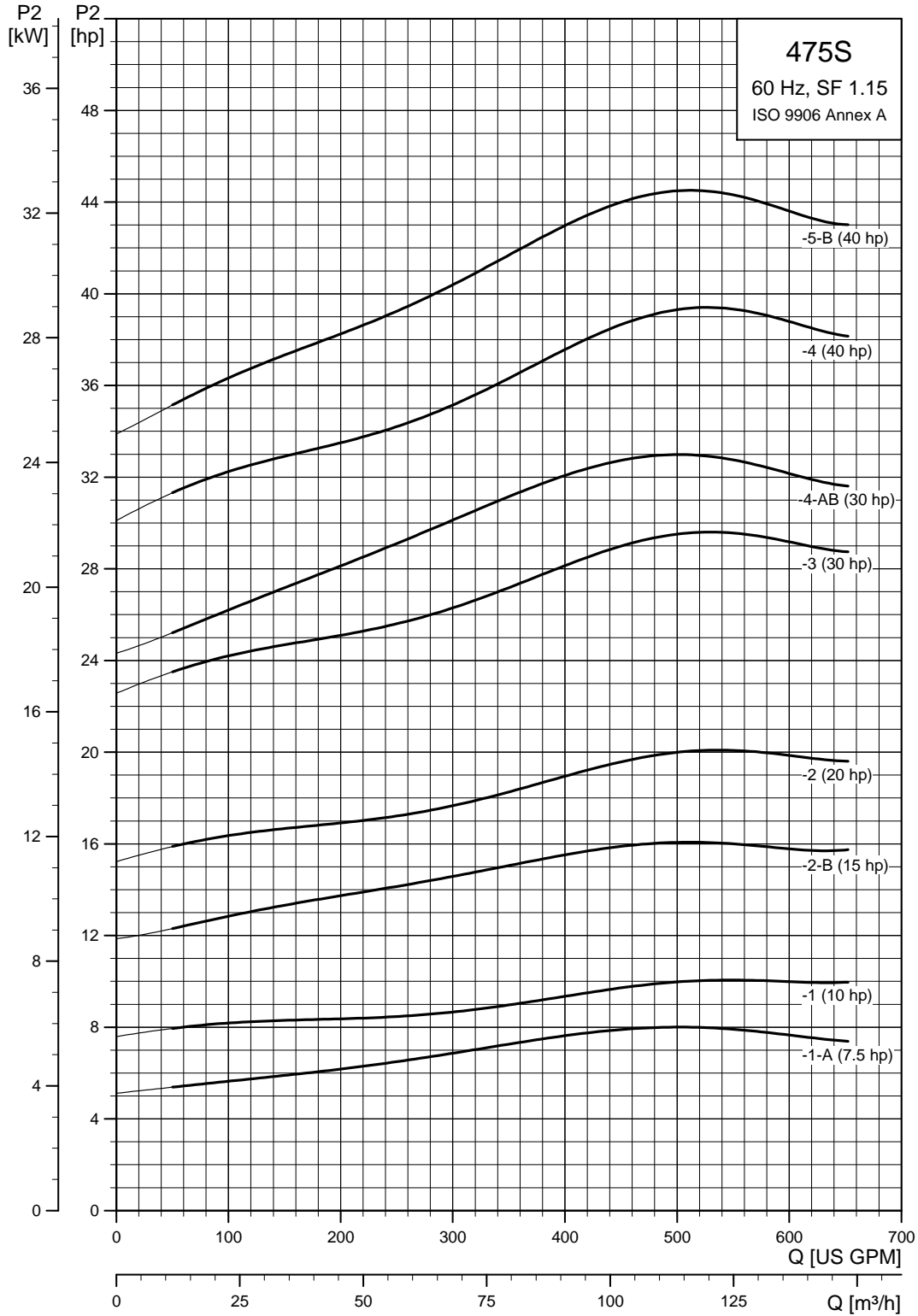

TM05 0257 1812

8" and larger wells - continued

SP 475S (475 gpm) pump power requirement (P2)

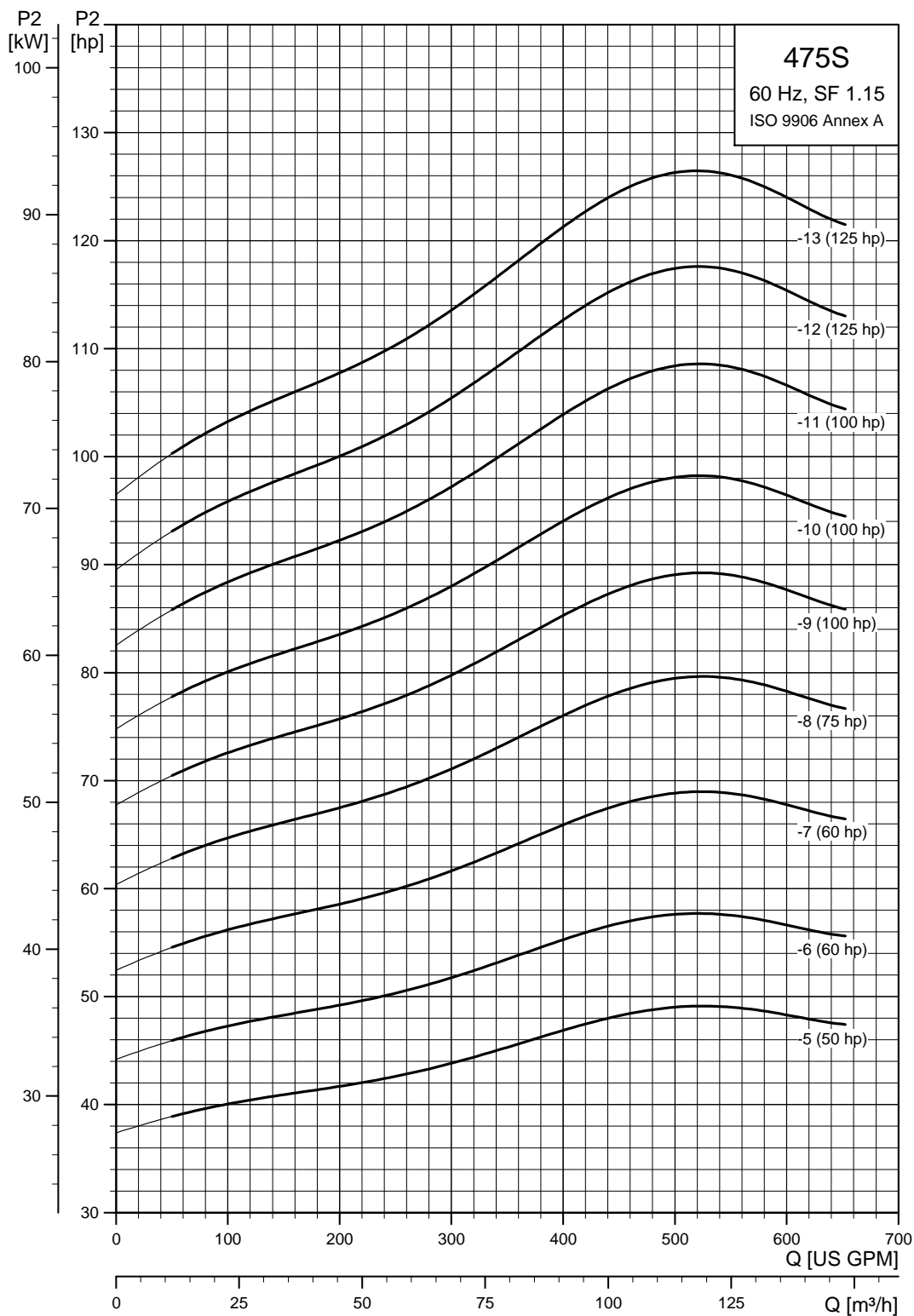

TM05 0258 1812

8" and larger wells - continued

SP 475S (475 gpm) pump with 6", 8" motors

Pump model	Nom. head [ft]	Ph	Motor			Dimensions [in (mm)]					Net weight (complete) [lb]	
			Volts [V]	[Hp]	[rpm]	A	B	C	D	E		
475S - Motor diameter 6 inch, 60 Hz, rated flow rate 475 gpm (6" NPT)												
-	-	3	208	5	▲	-	-	23.51 (597)	-	5.50 (139.5)	-	80.0
			230	5	▲	-	-	23.51 (597)	-	5.50 (139.5)	-	80.0
			460	5	▲	-	-	23.51 (597)	-	5.50 (139.5)	-	80.0
475S75-1A	51	3	230	7.5	▲	3484	46.58 (1183)	22.25 (565)	24.34 (618)	5.63 (143)	7.05 (179)	132.3
	51	3	460	7.5	▲	3495	46.58 (1183)	22.25 (565)	24.34 (618)	5.63 (143)	7.05 (179)	132.3
475S100-1	61	3	230	10	▲	3478	47.56 (1208)	23.23 (590)	24.34 (618)	5.63 (143)	7.05 (179)	132.3
	61	3	460	10	▲	3490	47.56 (1208)	23.23 (590)	24.34 (618)	5.63 (143)	7.05 (179)	132.3
475S150-2B	108	3	230	15	▲	3474	57.25 (1454)	27.88 (708)	29.38 (746)	5.63 (143)	7.05 (179)	170.1
	108	3	460	15	▲	3480	57.25 (1454)	27.88 (708)	29.38 (746)	5.63 (143)	7.05 (179)	170.1
475S200-2	124	3	230	20	▲	3484	60.20 (1529)	30.83 (783)	29.38 (746)	5.63 (143)	7.05 (179)	198.7
	124	3	460	20	▲	3494	60.20 (1529)	30.83 (783)	29.38 (746)	5.63 (143)	7.05 (179)	198.7
475S250-3A	172	3	230	25	▲	3471	67.41 (1712)	33.00 (838)	34.41 (874)	5.63 (143)	7.05 (179)	218.2
	173	3	460	25	▲	3484	67.41 (1712)	33.00 (838)	34.41 (874)	5.63 (143)	7.05 (179)	218.2
475S300-3	186	3	230	30	▲	3477	69.97 (1777)	35.56 (903)	34.41 (874)	5.63 (143)	7.05 (179)	233.6
	187	3	460	30	▲	3489	69.97 (1777)	35.56 (903)	34.41 (874)	5.63 (143)	7.05 (179)	233.6
475S300-4AB	210	3	230	30	▲	3457	75.00 (1905)	35.56 (903)	39.45 (1002)	5.63 (143)	7.05 (179)	239.9
	212	3	460	30	▲	3472	75.00 (1905)	35.56 (903)	39.45 (1002)	5.63 (143)	7.05 (179)	239.9
475S400-4	251	3	460	40	▲	3491	79.73 (2025)	40.28 (1023)	39.45 (1002)	5.63 (143)	7.05 (179)	268.5
475S400-5B	284	3	460	40	▲	3460	84.77 (2153)	40.28 (1023)	44.49 (1130)	5.63 (143)	7.05 (179)	356.0
475S500-5	313	3	460	50	☼	3460	100.6 (2555)	56.11 (1425)	44.49 (1130)	5.67 (144)	7.05 (179)	384.0
475S500-6A	357	3	460	50	☼	3460	105.63 (2683)	56.11 (1425)	49.53 (1258)	5.67 (144)	7.05 (179)	385.0
475S600-6	375	3	460	60	☼	3456	106.19 (2697)	56.11 (1425)	50.08 (1272)	5.67 (144)	7.05 (179)	436.0
475S600-7	449	3	460	60	☼	3433	111.23 (2825)	56.11 (1425)	55.12 (1400)	5.67 (144)	7.05 (179)	446.0
475S - Motor diameter 8 inch, 60 Hz, rated flow rate 475 gpm (6" NPT)												
475S400-4	245	3	460	40	*	3462	83.71 (2126)	43.71 (1110)	40.00 (1016)	7.56 (192)	8.08 (205)	406.5
475S400-5B	284	3	460	40	*	3441	88.75 (2254)	43.71 (1110)	45.04 (1144)	7.56 (192)	8.08 (205)	444.0
475S500-5	317	3	460	50	*	3480	90.71 (2304)	45.67 (1160)	45.04 (1144)	7.56 (192)	8.08 (205)	420.4
475S500-6A	363	3	460	50	*	3480	95.75 (2432)	45.67 (1160)	50.08 (1272)	7.56 (192)	8.08 (205)	422.0
475S600-6	375	3	460	60	*	3519	100.08 (2542)	50.00 (1270)	50.08 (1272)	7.56 (192)	8.08 (205)	476.0
475S600-7	449	3	460	60	*	3505	105.12 (2670)	50.00 (1270)	55.12 (1400)	7.56 (192)	8.08 (205)	482.6
475S750-8	513	3	460	75	*	3518	113.31 (2878)	53.15 (1350)	60.16 (1528)	7.56 (192)	8.08 (205)	524.4
475S1000-9	582	3	460	100	*	3529	127.8 (3246)	62.60 (1590)	65.20 (1656)	7.56 (192)	8.08 (205)	631.0
475S1000-10	643	3	460	100	*	3512	132.84 (3374)	62.60 (1590)	70.24 (1784)	7.56 (192)	8.08 (205)	637.6
475S1000-11	711	3	460	100	*	3512	137.88 (3502)	62.60 (1590)	75.28 (1912)	7.56 (192)	8.08 (205)	644.3
475S1250-12	771	3	460	125	*	3505	152.37 (3870)	72.05 (1830)	80.32 (2040)	7.56 (192)	8.08 (205)	754.1
475S1250-13	831	3	460	125	*	3497	157.41 (3998)	72.05 (1830)	85.36 (2168)	7.56 (192)	8.08 (205)	760.7

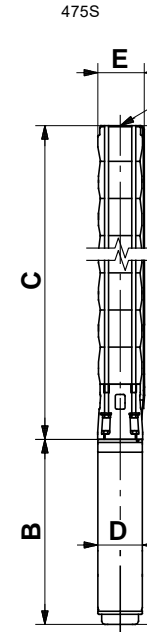

TM00 7872 2196

E = Maximum diameter of pump including cable guard and motor.

Notes:

Performance conforms to ISO 9906. 1999 (E) Annex A. Minimum submergence is 8 ft (2.4 m).

- ▲ MS 6000C motor.
- ☼ Takes MMS 6 motor; not available as complete.
- * Takes MMS 8000 motor; not available as complete.

10" and larger wells

SP 625S (625 gpm)

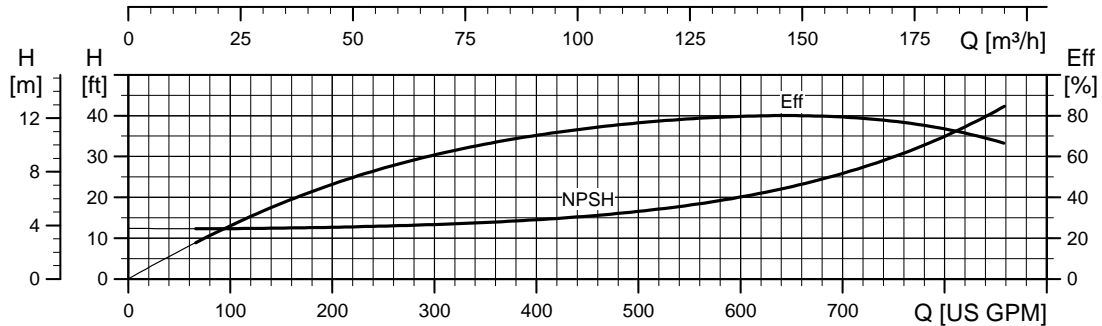
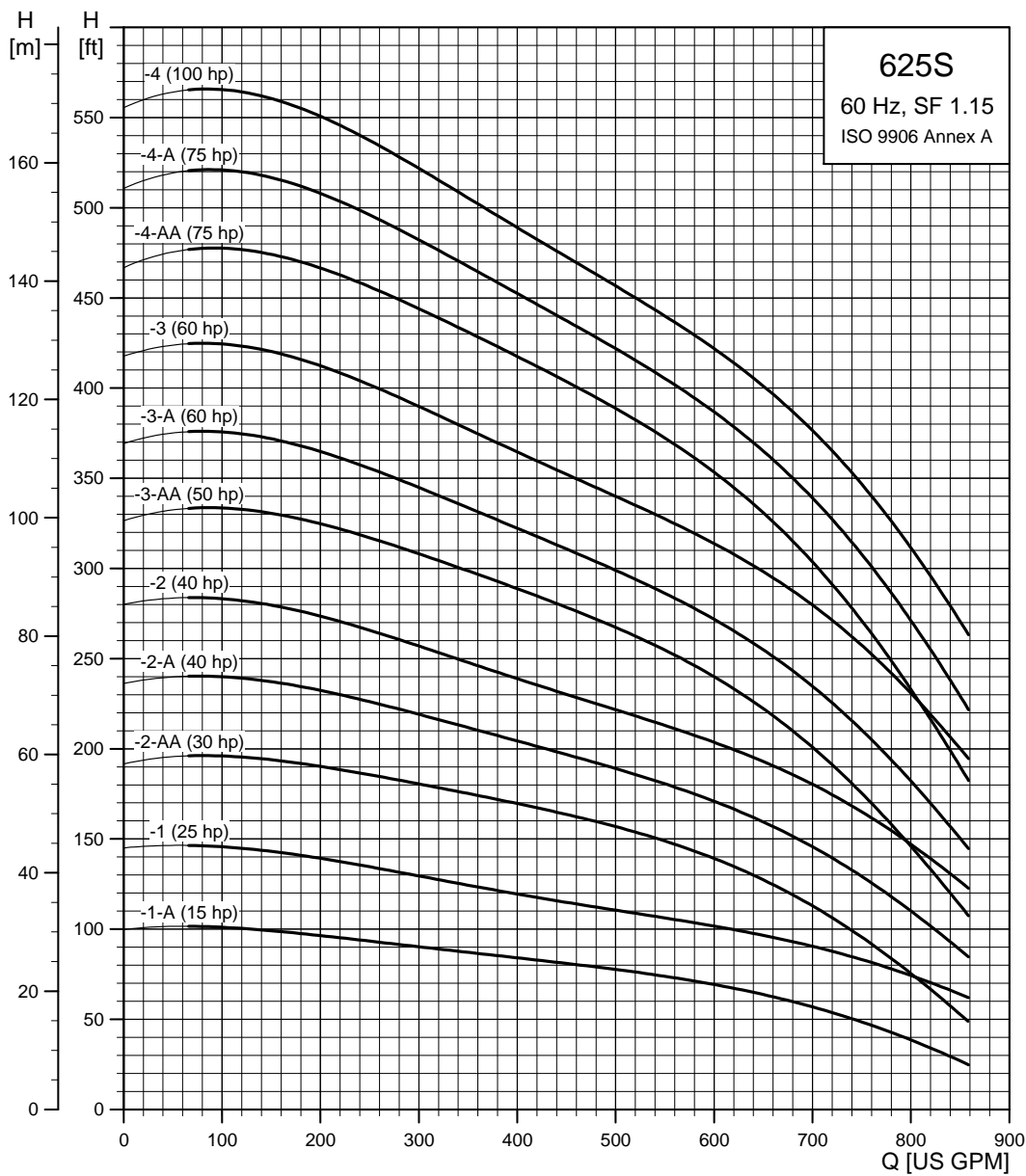

TM05 0259 1812

10" and larger wells - continued

SP 625S (625 gpm)

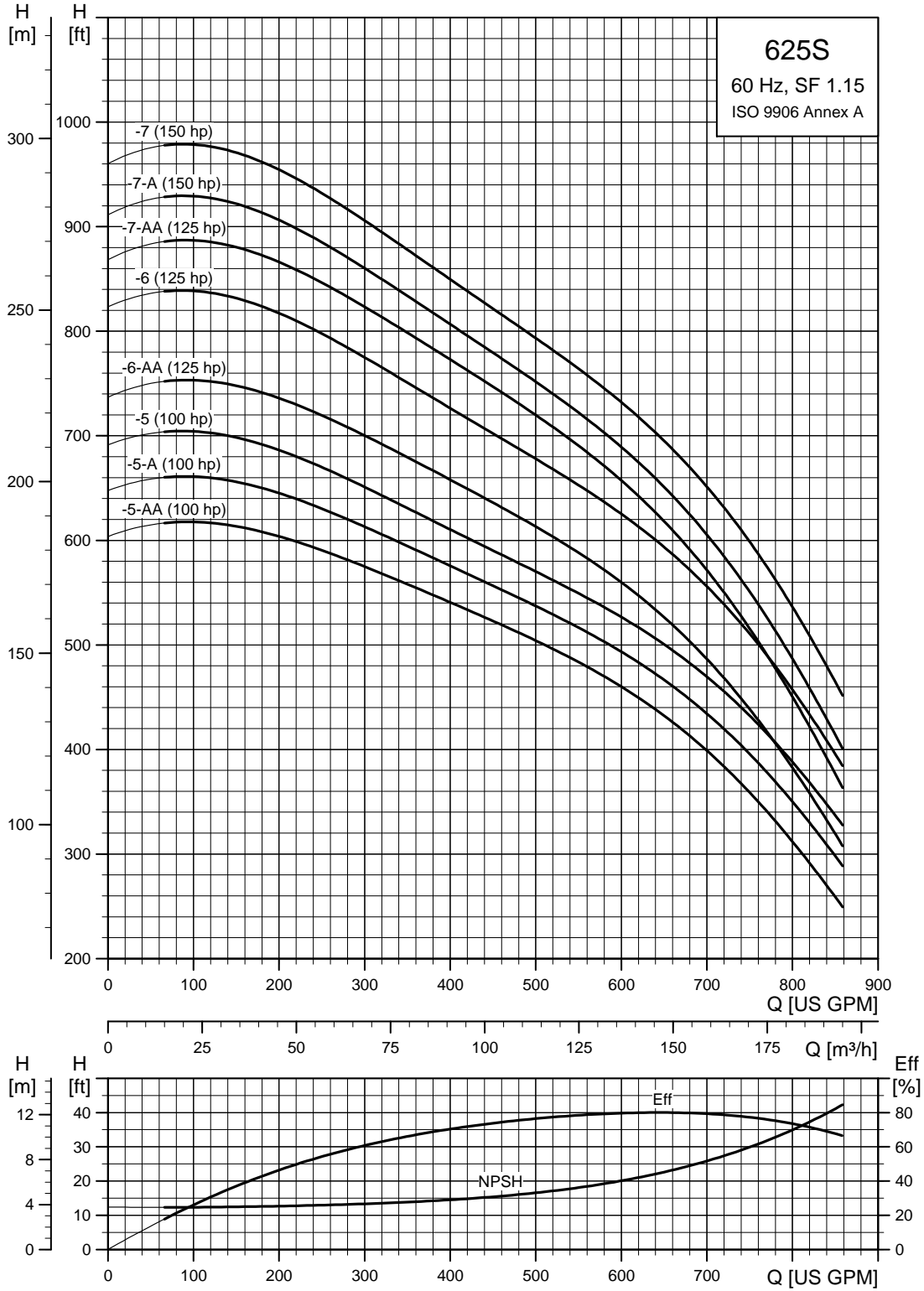

TM05 0260 1812

10" and larger wells - continued

SP 625S (625 gpm) pump power requirement (P2)

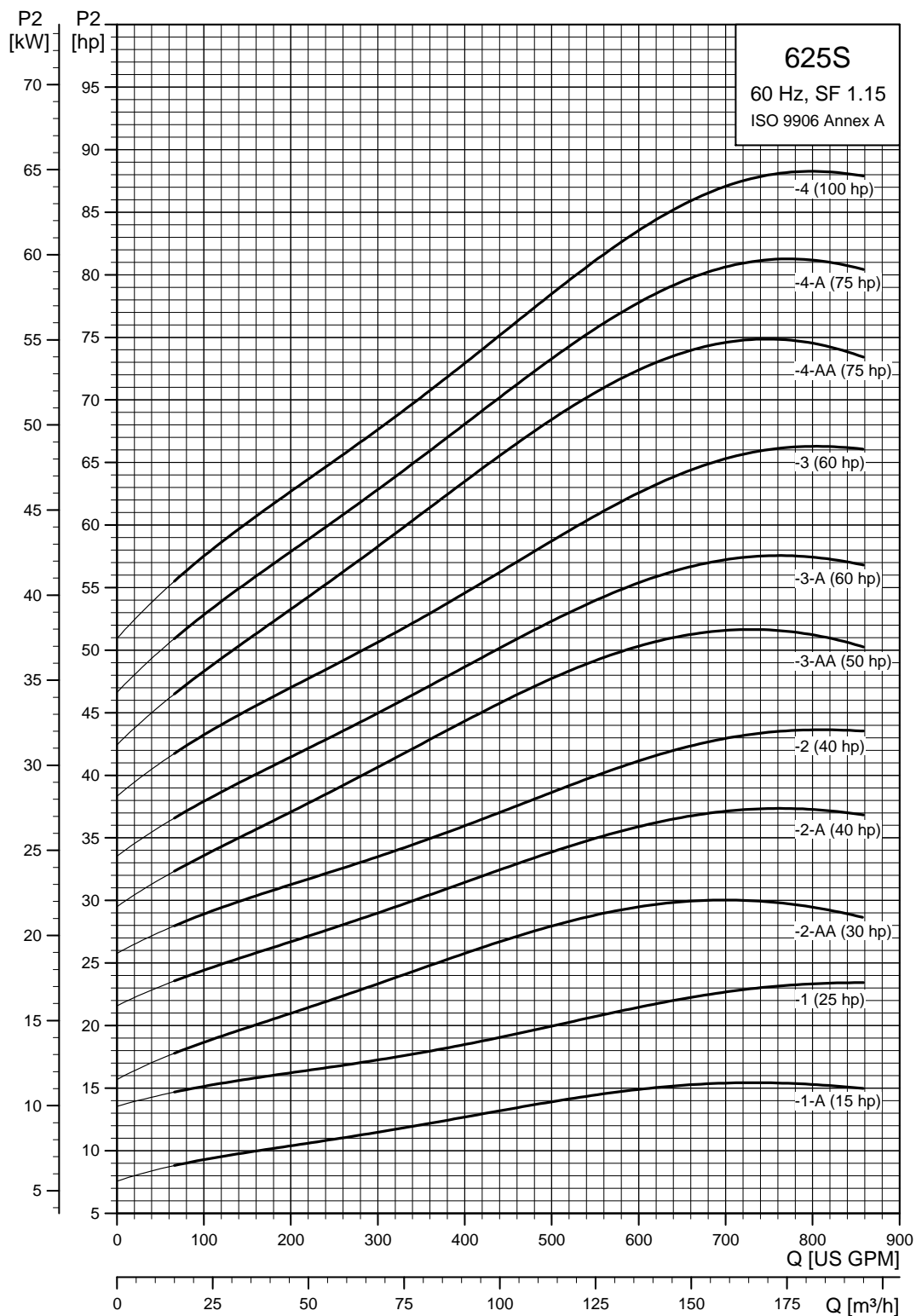

TM05 0261 1812

10" and larger wells - continued

SP 625S (625 gpm) pump power requirement (P2)

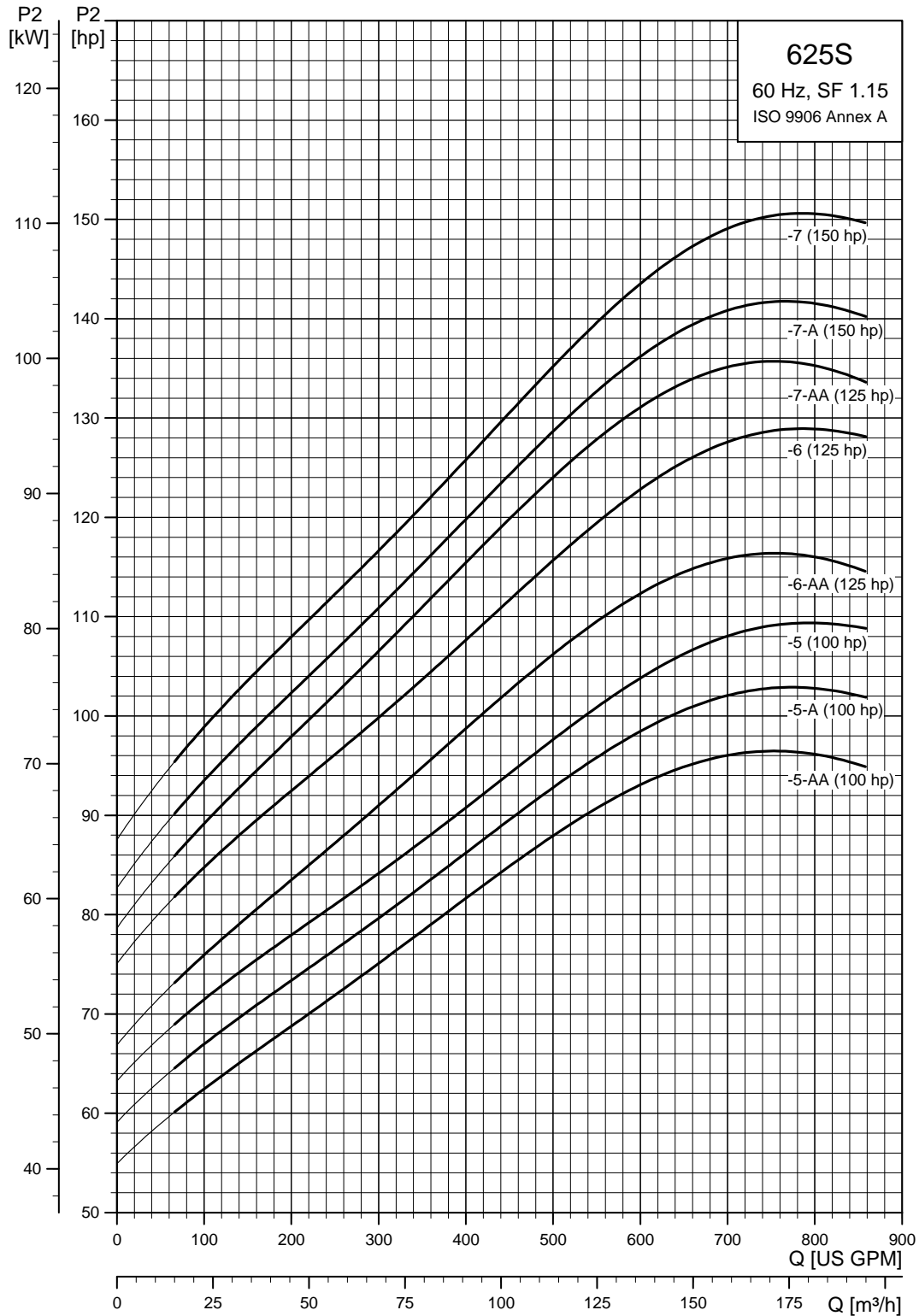

TMM05 0262 1812

10" and larger wells - continued

SP 625S (625 gpm) pump with 6", 8" motors

Pump model	Nom. head [ft]	Motor				Dimensions [in (mm)]					Net weight (complete) [lb]	
		Ph	Volts [V]	[Hp]	[rpm]	A	B	C	D	E		
625S - Motor diameter 6 inch, 60 Hz, rated flow rate 625 gpm (6" NPT)												
625S150-1A	76	3	230	15	▲	3486	53.51 (1359)	27.88 (708)	25.63 (651)	5.63 (143)	8.31 (211)	193.0
		3	460	15	▲	3491	53.51 (1359)	27.88 (708)	25.63 (651)	5.63 (143)	8.31 (211)	193.0
625S250-1	101	3	230	25	▲	3502	58.63 (1489)	33.00 (838)	25.63 (651)	5.63 (143)	8.31 (211)	189.9
		3	460	25	▲	3511	58.63 (1489)	33.00 (838)	25.63 (651)	5.63 (143)	8.31 (211)	198.9
625S300-2AA	143	3	230	30	▲	3476	67.33 (1710)	35.56 (903)	31.78 (807)	5.63 (143)	8.31 (211)	213.0
		3	460	30	▲	3488	67.33 (1710)	35.56 (903)	31.78 (807)	5.63 (143)	8.31 (211)	222.3
625S400-2A	171	3	460	40	▲	3499	72.05 (1830)	40.28 (1023)	31.78 (807)	5.63 (143)	8.31 (211)	333.8
625S400-2	203	3	460	40	▲	3482	72.05 (1830)	40.28 (1023)	31.78 (807)	5.63 (143)	8.31 (211)	333.8
625S500-3AA	240	3	460	50	☼	3475	94.02 (2388)	56.11 (1425)	37.94 (963)	5.63 (143)	8.31 (211)	376.4
625S600-3A	267	3	460	60	☼	3467	94.03 (2388)	56.11 (1425)	37.92 (963)	5.63 (143)	8.31 (211)	382.0
625S600-3	301	3	460	60	☼	3453	94.03 (2388)	56.11 (1425)	37.92 (963)	5.63 (143)	8.31 (211)	382.0
625S - Motor diameter 8 inch, 60 Hz, rated flow rate 625 gpm (6" NPT)												
625S400-2	205	3	460	40	*	3498	76.03 (1931)	43.71 (1110)	32.33 (821)	7.56 (192)	8.39 (213)	409.4
625S500-3AA	243	3	460	50	*	3498	83.59 (2123)	45.67 (1160)	37.92 (963)	7.56 (192)	8.39 (213)	444.6
625S600-3A	278	3	460	60	*	3520	87.92 (2233)	50.00 (1270)	37.92 (963)	7.56 (192)	8.39 (213)	490.8
625S600-3	299	3	460	60	*	3510	87.92 (2233)	50.00 (1270)	37.92 (963)	7.56 (192)	8.39 (213)	490.8
625S750-4AA	350	3	460	75	*	3524	97.21 (2469)	53.15 (1350)	44.06 (1119)	7.56 (192)	8.39 (213)	534.8
625S750-4A	384	3	460	75	*	3518	97.21 (2469)	53.15 (1350)	44.06 (1119)	7.56 (192)	8.39 (213)	534.8
625S1000-4	402	3	460	100	*	3529	106.66 (2709)	62.60 (1590)	44.06 (1119)	7.56 (192)	8.39 (213)	633.8
625S1000-5AA	460	3	460	100	*	3524	112.76 (2864)	62.60 (1590)	50.16 (1274)	7.56 (192)	8.39 (213)	649.3
625S1000-5A	490	3	460	100	*	3519	112.76 (2864)	62.60 (1590)	50.16 (1274)	7.56 (192)	8.39 (213)	649.3
625S1000-5	500	3	460	100	*	3513	112.76 (2864)	62.60 (1590)	50.16 (1274)	7.56 (192)	8.39 (213)	649.3
625S1250-6AA	557	3	460	125	*	3507	128.31 (3259)	72.05 (1830)	56.26 (1429)	7.56 (192)	8.39 (213)	761.5
625S1250-6	590	3	460	125	*	3495	128.31 (3259)	72.05 (1830)	56.26 (1429)	7.56 (192)	8.39 (213)	761.5
625S1250-7AA	655	3	460	125	*	3490	134.45 (3415)	72.05 (1830)	62.41 (1585)	7.56 (192)	8.39 (213)	774.7
625S1500-7A	696	3	460	150	*	3505	143.51 (3645)	81.11 (2060)	62.41 (1585)	7.56 (192)	8.39 (213)	884.7
625S1500-7	690	3	460	150	*	3499	143.51 (3645)	81.11 (2060)	62.41 (1585)	7.56 (192)	8.39 (213)	884.7

Notes:

Performance conforms to ISO 9906. 1999 (E) Annex A. Minimum submergence is 10 ft (3 m).

- ▲ MS 6000C motor.
- ☼ Takes MMS 6 motor; not available as complete.
- * Takes MMS 8000 motor; not available as complete.

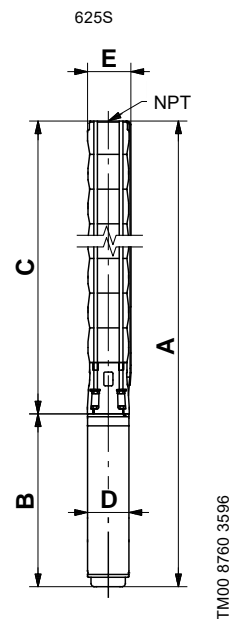

E = Maximum diameter of pump including cable guard and motor.

10" and larger wells - continued

SP 800S (800 gpm)

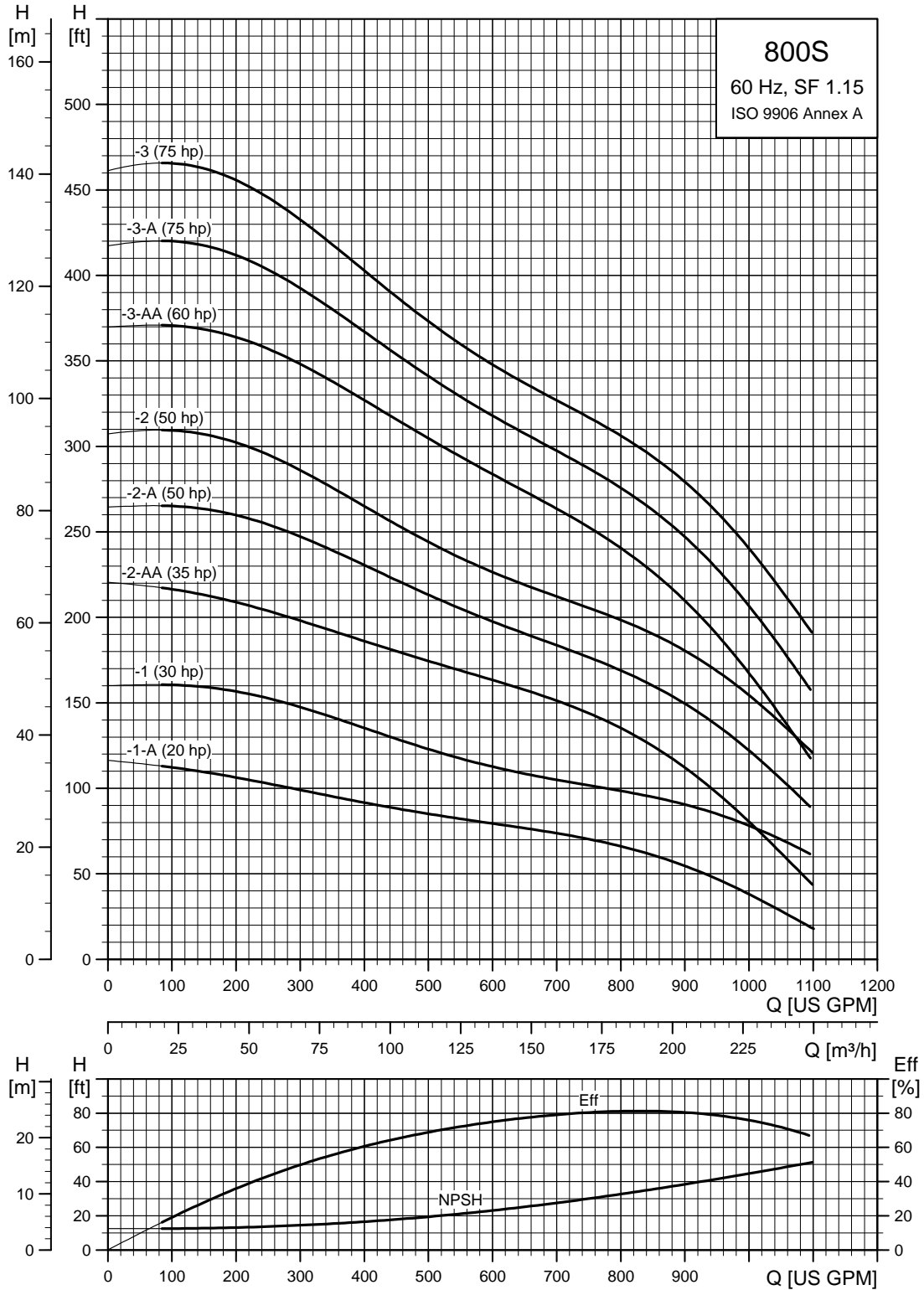

TM05 0263 1812

10" and larger wells - continued

SP 800S (800 gpm)

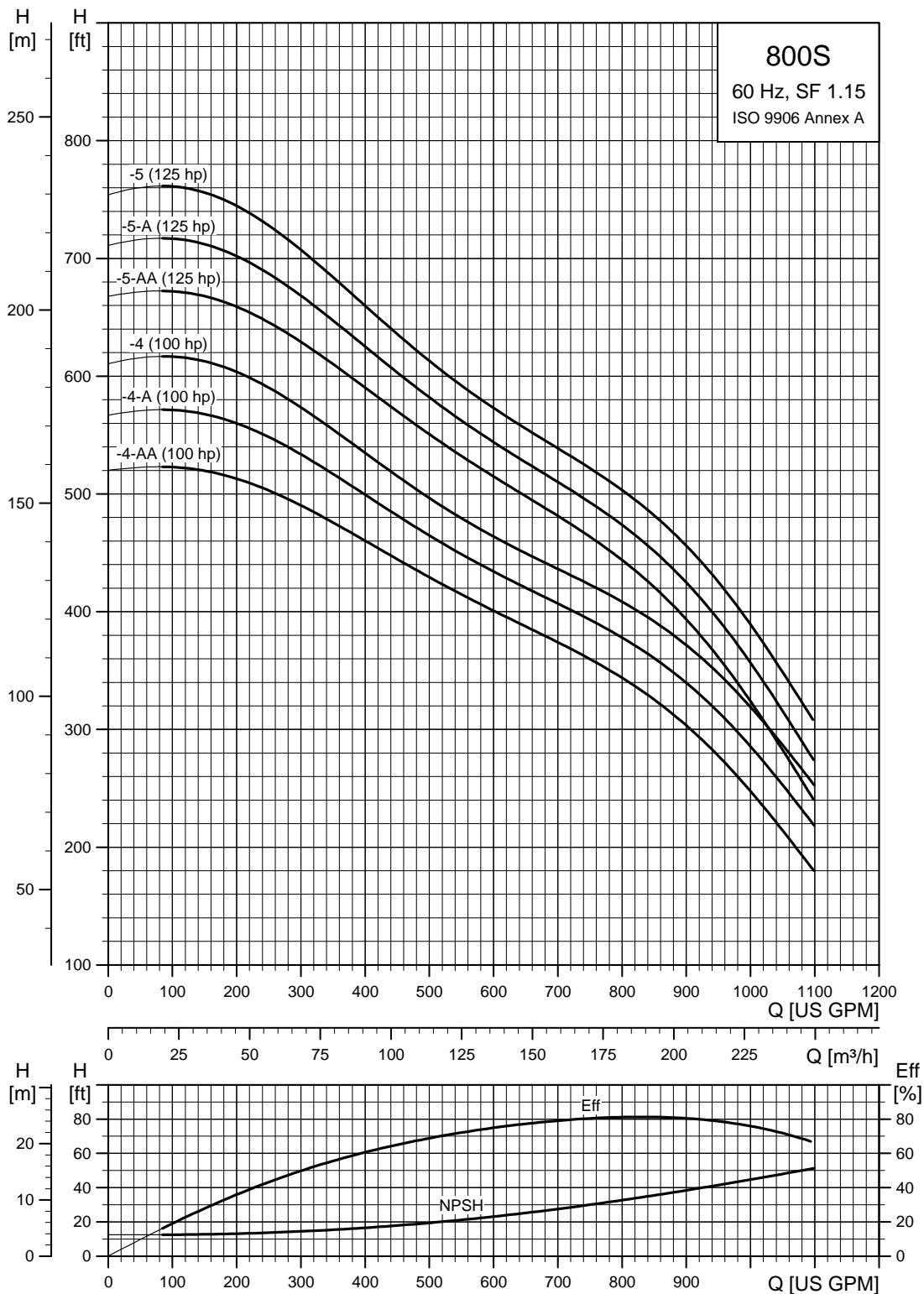

TM05 0264 1812

10" and larger wells - continued

SP 800S (800 gpm) pump power requirement (P2)

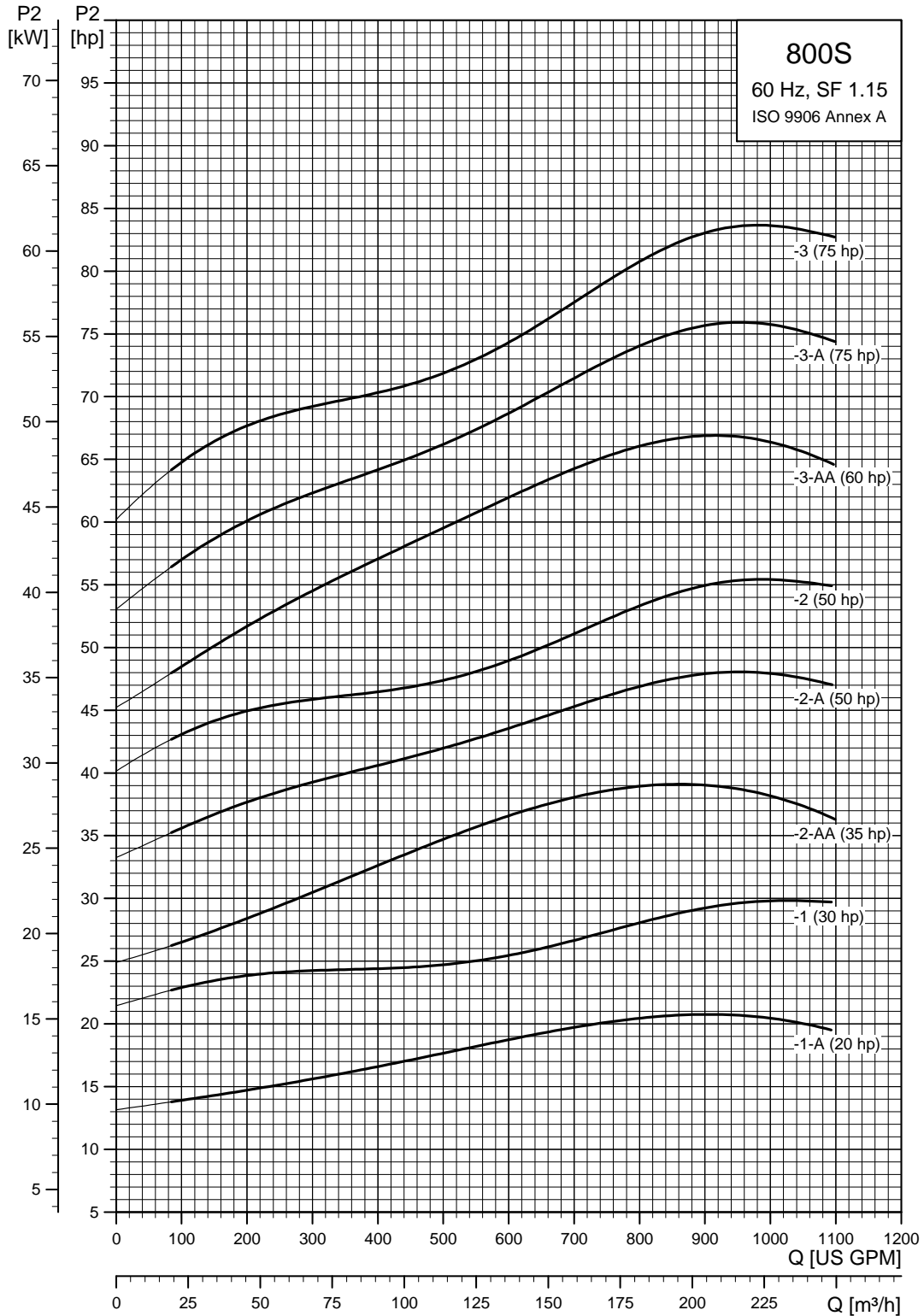

TM05 0265 1812

10" and larger wells - continued

SP 800S (800 gpm) pump power requirement (P2)

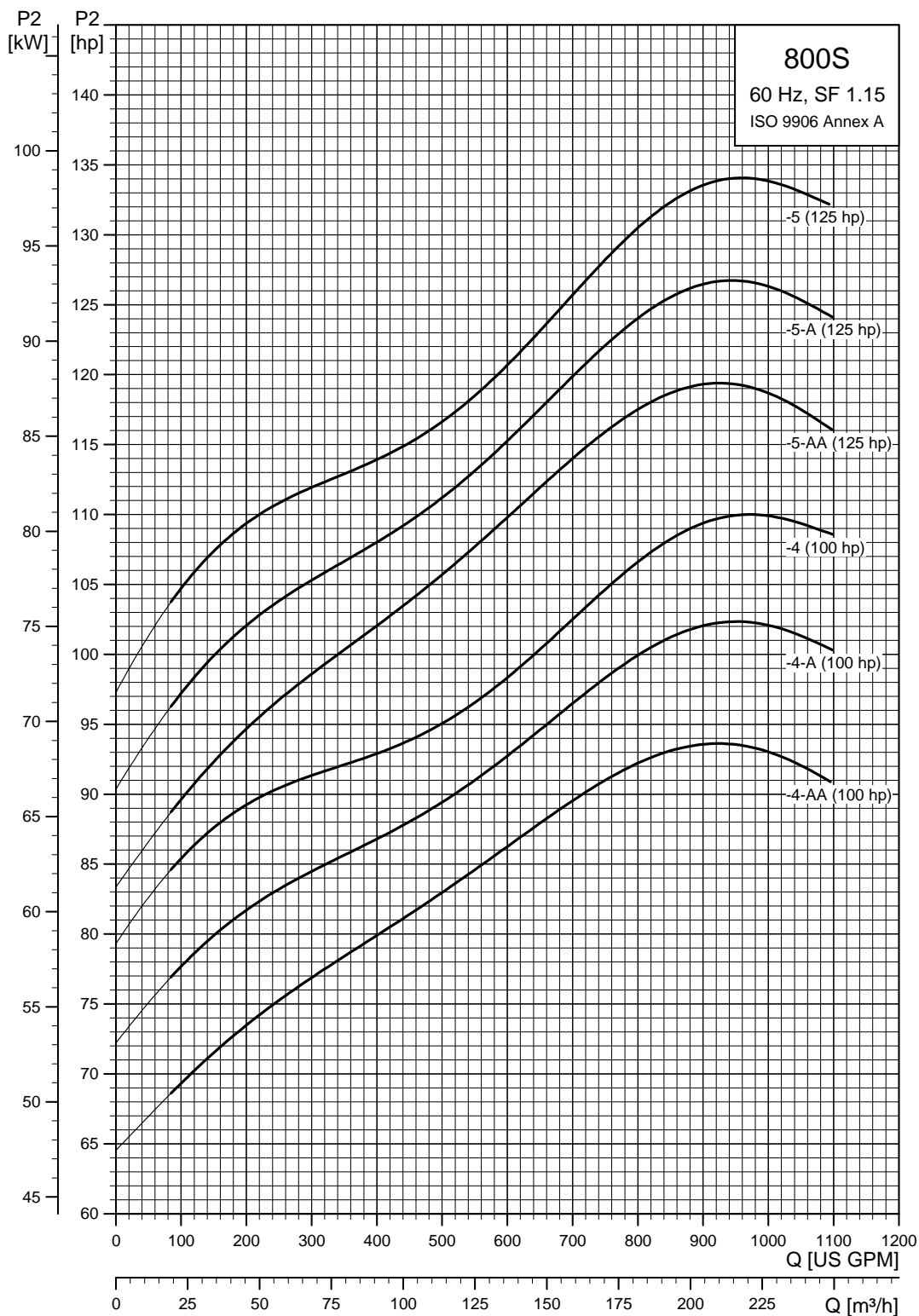

TM05 0266 1812

10" and larger wells - continued

SP 800S (800 gpm) pump with 6", 8" motors

Pump model	Nom. head [ft]	Motor				Dimensions [in (mm)]					Net weight (complete) [lb]	
		Ph	Volts [V]	[Hp]	[rpm]	A	B	C	D	E		
800S - Motor diameter 6 inch, 60 Hz, rated flow rate 800 gpm (6" NPT)												
800S200-1A	72	3	230	20	▲	3481	56.50 (1435)	30.83 (783)	25.67 (652)	5.63 (143)	8.31 (211)	180.0
	72	3	460	20	▲	3492	56.50 (1435)	30.83 (783)	25.67 (652)	5.63 (143)	8.31 (211)	180.0
800S300-1	95	3	230	30	▲	3479	61.23 (1555)	35.56 (903)	25.67 (652)	5.63 (143)	8.31 (211)	202.5
	96	3	460	30	▲	3491	61.23 (1555)	35.56 (903)	25.67 (652)	5.63 (143)	8.31 (211)	202.5
800S400-2AA	143	3	460	40	▲	3490	72.05 (1830)	40.28 (1023)	31.78 (807)	5.63 (143)	8.31 (211)	257.4
800S500-2A	172	3	460	50	☼	3486	88.00 (2235)	56.11 (1425)	31.87 (810)	5.63 (143)	8.39 (213)	363.2
800S500-2	189	3	460	50	☼	3463	88.00 (2235)	56.11 (1425)	31.87 (810)	5.63 (143)	8.39 (213)	363.2
800S600-3AA	239	3	460	60	☼	3446	94.03 (2388)	56.11 (1425)	37.92 (963)	5.63 (143)	8.39 (213)	381.4
800S - Motor diameter 8 inch, 60 Hz, rated flow rate 800 gpm (6" NPT)												
800S400-2AA	141	3	460	40	*	3462	75.48 (1917)	43.71 (1110)	31.78 (807)	7.56 (192)	8.39 (213)	409.4
800S500-2A	174	3	460	50	*	3507	77.45 (1967)	45.67 (1160)	31.78 (807)	7.56 (192)	8.39 (213)	431.4
800S500-2	192	3	460	50	*	3489	77.45 (1967)	45.67 (1160)	31.78 (807)	7.56 (192)	8.39 (213)	438.0
800S600-3AA	247	3	460	60	*	3508	87.92 (2233)	50.00 (1270)	37.92 (963)	7.56 (192)	8.39 (213)	490.8
800S750-3A	281	3	460	75	*	3523	91.07 (2313)	53.15 (1350)	37.92 (963)	7.56 (192)	8.39 (213)	523.8
800S750-3	293	3	460	75	*	3514	91.07 (2313)	53.15 (1350)	37.92 (963)	7.56 (192)	8.39 (213)	523.8
800S1000-4AA	354	3	460	100	*	3524	106.62 (2708)	62.60 (1590)	44.02 (1118)	7.56 (192)	8.39 (213)	633.8
800S1000-4A	385	3	460	100	*	3519	106.62 (2708)	62.60 (1590)	44.02 (1118)	7.56 (192)	8.39 (213)	633.8
800S1000-4	390	3	460	100	*	3511	106.62 (2708)	62.60 (1590)	44.02 (1118)	7.56 (192)	8.39 (213)	633.8
800S1250-5AA	454	3	460	125	*	3503	122.21 (3104)	72.05 (1830)	50.16 (1274)	7.56 (192)	8.39 (213)	748.3
800S1250-5A	457	3	460	125	*	3496	122.21 (3104)	72.05 (1830)	50.16 (1274)	7.56 (192)	8.39 (213)	748.3
800S1250-5	479	3	460	125	*	3489	122.21 (3104)	72.05 (1830)	50.16 (1274)	7.56 (192)	8.39 (213)	746.6

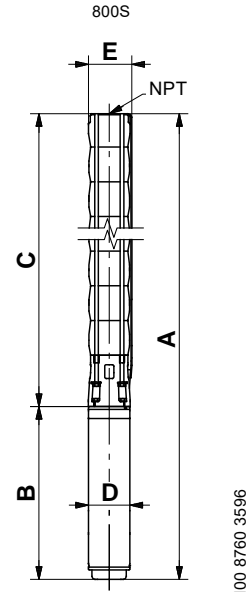

TM00 8760 3596

E = Maximum diameter of pump including cable guard and motor.

Notes:

Performance conforms to ISO 9906. 1999 (E) Annex A. Minimum submergence is 25 ft (7.6 m).

- ▲ MS 6000C motor.
- ☼ Takes MMS 6 motor; not available as complete.
- * Takes MMS 8000 motor; not available as complete.

10" and larger wells - continued

SP 1100S (1100 gpm)

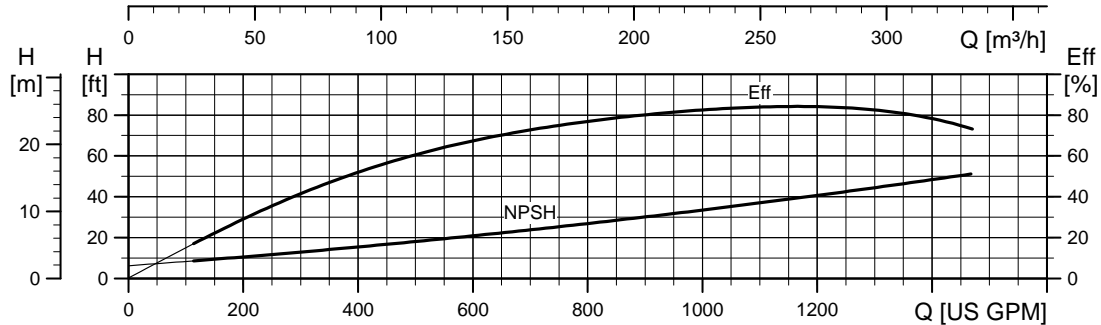
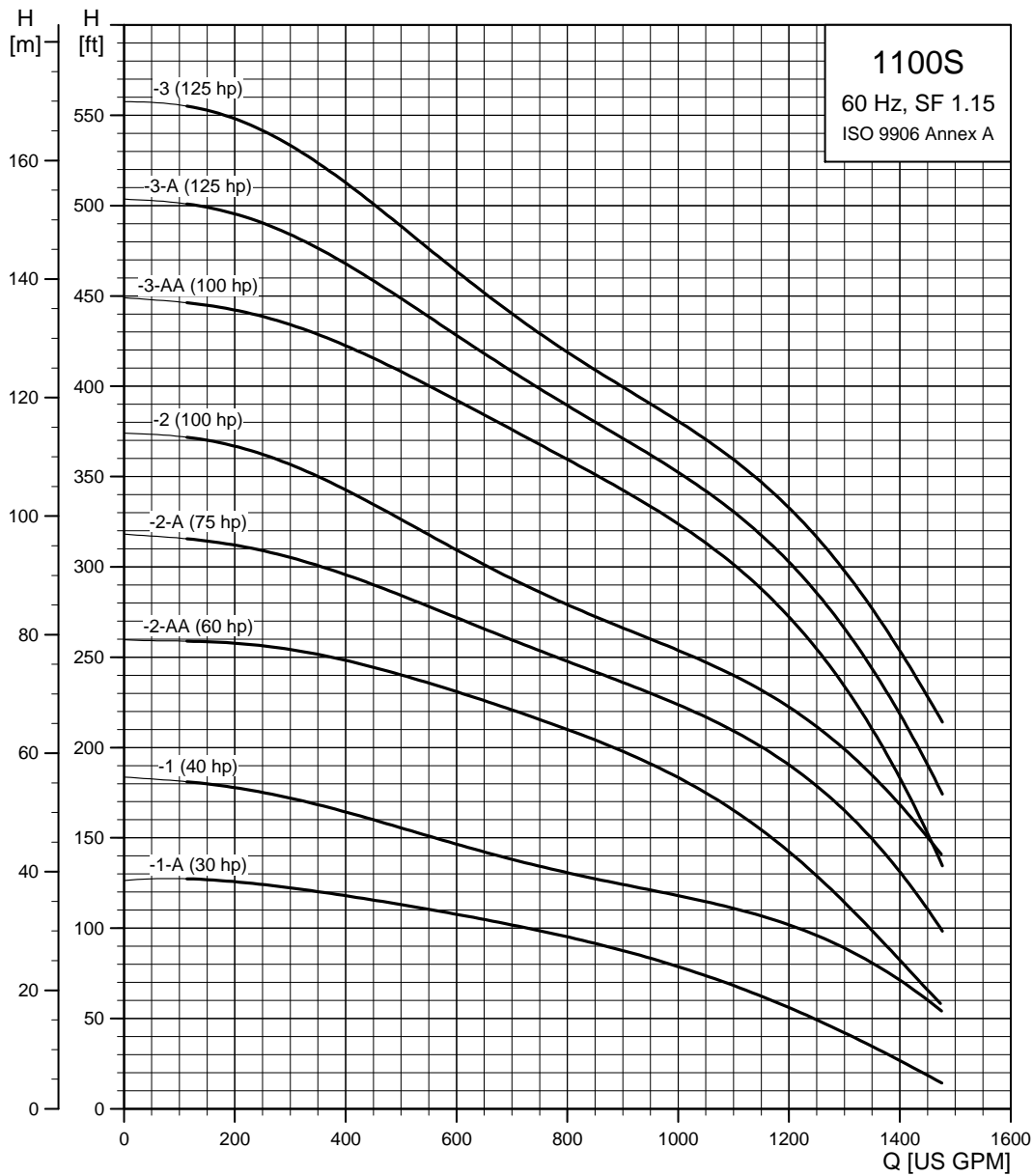

TM05 0267 1812

10" and larger wells - continued

SP 1100S (1100 gpm)

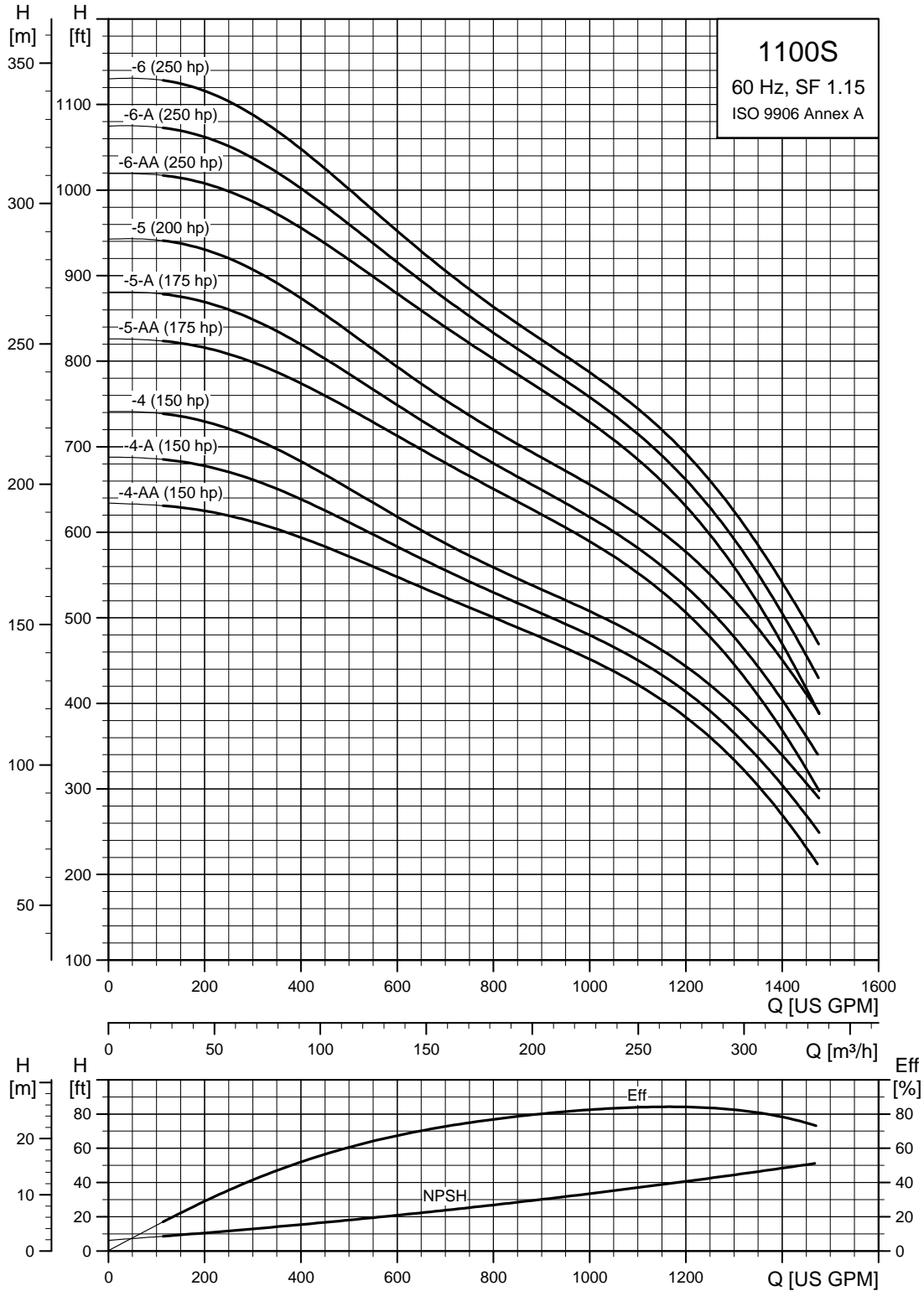

TM05 0268 1812

10" and larger wells - continued

SP 1100S (1100 gpm) pump power requirement (P2)

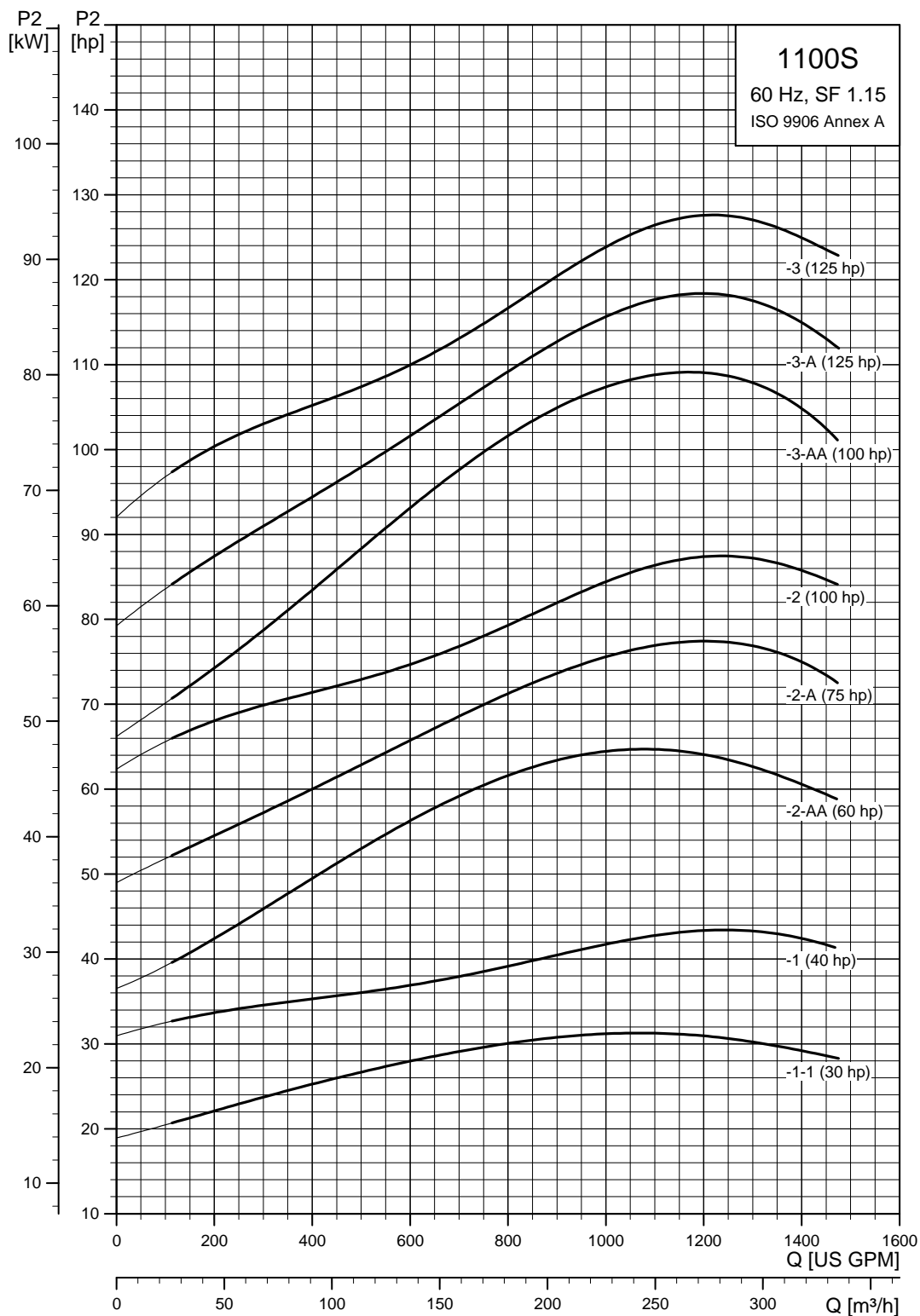

TM05 0269 1812

10" and larger wells - continued

SP 1100S (1100 gpm) pump power requirement (P2)

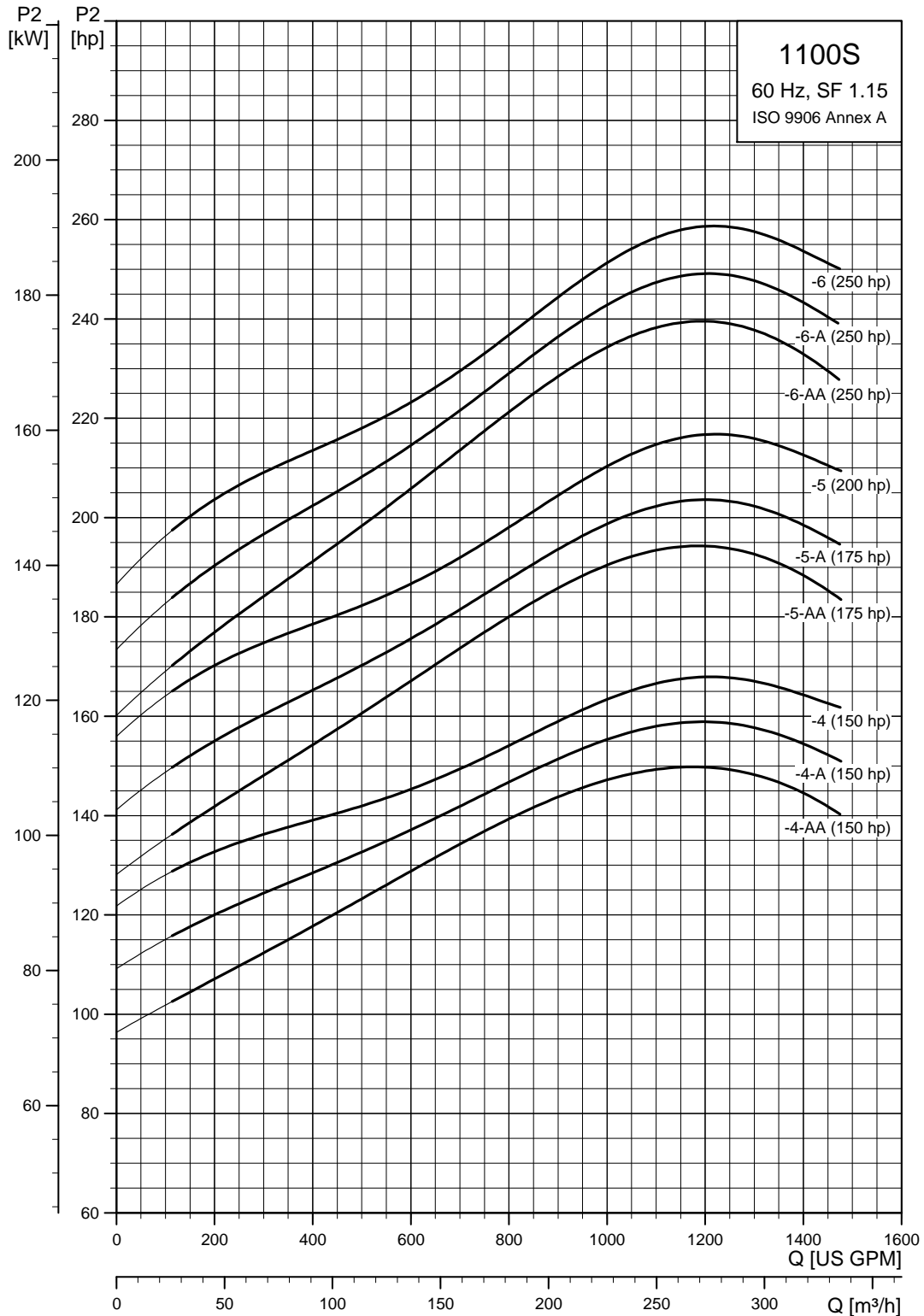

TM05 0270 1812

10" and larger wells - continued

SP 1100S (1100 gpm) pump with 6", 8", 10" motors

Pump model	Nom. head [ft]	Motor				Dimensions [in (mm)]					Net weight (complete) [lb]	
		Ph	Volts [V]	[Hp]	[rpm]	A	B	C	D	E		
1100S - Motor diameter 6 inch, 60 Hz, rated flow rate 1100 gpm (6" NPT)												
1100S300-1A	77	3	230	30	▲	3449	66.66 (1693)	35.56 (903)	31.11 (790)	5.63 (143)	9.30 (236)	261.0
	89	3	460	30	▲	3481	66.66 (1693)	35.56 (903)	31.11 (790)	5.63 (143)	9.30 (236)	261.0
1100S400-1	109	3	460	40	▲	3476	71.38 (1813)	40.28 (1023)	31.11 (790)	5.63 (143)	9.30 (236)	290.6
1100S600-2AA	178	3	460	60	☼	3455	94.15 (2391)	56.11 (1425)	38.04 (966)	5.63 (143)	9.30 (236)	389.8
1100S - Motor diameter 8 inch, 60 Hz, rated flow rate 1100 gpm (6" NPT)												
1100S400-1	110	3	460	40	*	3493	74.81 (1900)	43.71 (1110)	31.11 (790)	7.56 (192)	9.41 (239)	407.2
1100S600-2AA	180	3	460	60	*	3510	88.04 (2236)	50.00 (1270)	38.04 (966)	7.56 (192)	9.41 (239)	501.8
1100S750-2A	217	3	460	75	*	3521	91.19 (2316)	53.15 (1350)	38.04 (966)	7.56 (192)	9.41 (239)	534.8
1100S1000-2	230	3	460	100	*	3529	100.63 (2556)	62.60 (1590)	38.04 (966)	7.56 (192)	9.41 (239)	633.8
1100S1000-3AA	314	3	460	100	*	3511	107.56 (2732)	62.60 (1590)	44.97 (1142)	7.56 (192)	9.41 (239)	655.9
1100S1250-3A	319	3	460	125	*	3503	117.01 (2972)	72.05 (1830)	44.97 (1142)	7.56 (192)	9.41 (239)	757.1
1100S1250-3	340	3	460	125	*	3495	117.01 (2972)	72.05 (1830)	44.97 (1142)	7.56 (192)	9.41 (239)	757.1
1100S1500-4AA	411	3	460	150	*	3498	133.00 (3378)	81.11 (2060)	51.89 (1318)	7.56 (192)	9.41 (239)	889.1
1100S1500-4A	431	3	460	150	*	3485	133.00 (3378)	81.11 (2060)	51.89 (1318)	7.56 (192)	9.41 (239)	889.1
1100S1500-4	450	3	460	150	*	3491	133.00 (3378)	81.11 (2060)	51.89 (1318)	7.56 (192)	9.41 (239)	889.1
1100S - Motor diameter 10 inch, 60 Hz, rated flow rate 1100 gpm (6" NPT)												
1100S1750-5AA	524	3	460	175	†	3510	132.45 (3364)	73.63 (1870)	58.82 (1494)	9.34 (237)	9.85 (250)	1142.2
1100S1750-5A	559	3	460	175	†	3446	132.45 (3364)	73.63 (1870)	58.82 (1494)	9.34 (237)	9.85 (250)	1137.0
1100S2000-5	577	3	460	200	†	3522	140.32 (3564)	81.5 (2070)	58.82 (1494)	9.34 (237)	9.85 (250)	1285.2
1100S2600-6AA	658	3	460	250	†	3520	160.24 (4070)	94.49 (2400)	65.75 (1670)	9.34 (237)	9.85 (250)	1478.0
1100S2600-6A	673	3	460	250	†	3520	160.24 (4070)	94.49 (2400)	65.75 (1670)	9.34 (237)	9.85 (250)	1483.2
1100S2600-6	703	3	460	250	†	3520	160.24 (4070)	94.49 (2400)	65.75 (1670)	9.34 (237)	9.85 (250)	1483.2

Notes:

Performance conforms to ISO 9906: 1999 (E) Annex A. Minimum submergence is 30 ft (9.1 m).

▲ MS 6000C motor.

☼ Takes MMS 6 motor; not available as complete.

* Takes MMS 8000 motor; not available as complete.

† Takes MMS 10000 motor; not available as complete.

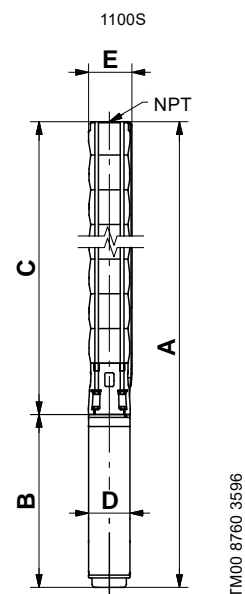









E = Maximum diameter of pump including cable guard and motor.

Motor type	Hp	kW	Volt [V]	Service factor	Full load				Service factor (max. load)				Locked rotor [A]**	KVA code	Max. thrust	RPM	
					[A]	[W]*	Power factor	Eff. [%]	[A]	[W]*	Power factor	Eff. [%]					
6" three phase 60 Hz motors																	
MS 6000C	5	3.70	208	1.15	16.9	4932	0.81	79.3	19.0	5681	0.83	79.3	95.0	H	6070	3480	
			230	1.15	16.2	4969	0.77	79.2	17.8	5673	0.80	79.9	105.0	H	6070	3510	
			460	1.15	8.0	4908	0.77	79.4	8.8	5609	0.80	80.2	51.3	H	6070	3500	
	7.5	5.50	208	1.15	24.2	7149	0.82	80.2	27.5	8223	0.83	79.4	114.0	H	6070	3450	
			230	1.15	23.4	7178	0.77	80.6	26.0	8286	0.80	80.8	130.0	H	6070	3480	
			440	1.15	11.6	7161	0.81	80.6	13.2	8249	0.82	80.4	61.0	J	6070	3470	
			460	1.15	11.6	7117	0.77	80.6	13.0	8286	0.80	80.8	64.5	J	6070	3480	
			480	1.15	12.0	7283	0.73	80.2	13.0	8322	0.77	80.7	68.0	J	6070	3490	
			575	1.15	9.3	7186	0.78	80.6	10.2	8228	0.81	80.8	51.0	H	6070	3480	
	10	7.50	208	1.15	32.0	9684	0.84	80.5	37.5	11483	0.85	79.2	126.0	G	6070	3420	
			230	1.15	30.0	9680	0.81	81.7	33.5	11077	0.83	81.5	142.0	G	6070	3470	
			440	1.15	15.2	9615	0.83	81.5	17.4	11139	0.84	81.7	67.5	G	6070	3450	
			460	1.15	15.0	9680	0.81	81.8	16.8	11110	0.83	81.7	71.0	G	6070	3470	
			480	1.15	15.0	9602	0.77	81.8	16.6	11041	0.80	82.0	75.0	G	6070	3480	
			575	1.15	12.0	9680	0.81	81.4	13.4	11077	0.83	81.2	56.5	G	6070	3470	
	15	11.00	208	1.15	46.5	14072	0.84	82.1	53.5	16383	0.85	81.1	198.0	G	6070	3430	
			230	1.15	44.5	14005	0.79	83.0	49.5	16170	0.82	82.9	224.0	G	6070	3470	
			440	1.15	22.0	13916	0.83	82.8	25.0	16004	0.84	82.1	100.0	H	6070	3450	
			460	1.15	21.6	13940	0.81	83.1	24.4	16136	0.83	82.8	106.0	H	6070	3470	
			480	1.15	21.6	13828	0.77	83.1	24.0	15963	0.80	83.2	112.0	H	6070	3480	
			575	1.15	17.2	13875	0.81	83.0	19.4	16036	0.83	82.7	84.0	G	6070	3460	
	20	15.00	208	1.15	61.5	19054	0.86	82.7	71.5	22153	0.86	81.5	310.0	H	6070	3430	
			230	1.15	57.5	18783	0.82	84.0	65.0	21751	0.84	83.7	350.0	H	6070	3470	
			440	1.15	29.0	18565	0.84	83.7	33.5	21701	0.85	82.9	166.0	J	6070	3450	
			460	1.15	29.0	18947	0.82	84.0	32.5	21751	0.84	83.7	176.0	J	6070	3470	
			480	1.15	29.0	18806	0.78	83.9	32.0	21549	0.81	83.9	186.0	J	6070	3480	
			575	1.15	23.4	18877	0.81	83.8	26.0	21492	0.83	83.5	144.0	J	6070	3480	
	25	18.50	208	1.15	75.0	23237	0.86	83.4	87.0	26955	0.86	82.3	395.0	J	6070	3430	
			230	1.15	71.0	22910	0.81	84.6	80.0	26452	0.83	84.3	445.0	J	6070	3480	
			440	1.15	36.0	23046	0.84	84.3	41.0	26559	0.85	83.6	212.0	J	6070	3460	
			460	1.15	35.5	22910	0.81	84.6	40.0	26452	0.83	84.3	224.0	J	6070	3480	
			480	1.15	36.0	23046	0.77	84.3	39.5	26272	0.80	84.4	236.0	J	6070	3490	
			575	1.15	28.5	23275	0.82	84.0	32.0	26452	0.83	83.7	180.0	J	6070	3480	
	30	22.00	208	1.15	88.0	27582	0.87	83.3	104.0	32597	0.87	81.8	445.0	H	6070	3420	
			230	1.15	81.0	27105	0.84	85.1	92.0	31153	0.85	84.4	500.0	H	6070	3470	
			440	1.15	41.5	27199	0.86	84.5	48.0	31825	0.87	83.5	238.0	J	6070	3450	
			460	1.15	40.5	27105	0.84	85.1	46.0	31153	0.85	84.4	250.0	J	6070	3470	
			480	1.15	40.0	26937	0.81	85.2	45.0	31052	0.83	85.0	265.0	J	6070	3480	
			575	1.15	32.0	27089	0.85	84.8	37.0	31690	0.86	84.0	194.0	H	6070	3460	
	40	30.00	440	1.15	56.0	37130	0.87	84.7	65.0	43592	0.88	83.6	290.0	H	6070	3440	
			460	1.15	54.5	36909	0.85	85.2	62.0	42482	0.86	84.7	310.0	H	6070	3460	
			480	1.15	54.5	37155	0.82	85.3	61.0	42600	0.84	85.1	330.0	H	6070	3480	
				575	1.15	43.5	36824	0.85	85.2	49.5	42890	0.87	84.7	250.0	G	6070	3470
	6" three phase 60 Hz motors																
	MMS 6	50	37.00	460	1.15	73.0	47111	0.81	83.2	82.0	54226	0.83	82.6	405	H	6000	3450
	MMS 6	60	45.00	460	1.15	86.3	57070	0.83	85.0	97.0	66464	0.86	86.0	525	G	6000	3455
	8" three phase 60 Hz motors																
	MMS 8000	40	30.00	460	1.15	53.3	36096	0.85	82.5	64.0	43853	0.86	83.0	371	K	13000	3490
50		37.00	460	1.15	65.6	44426	0.85	83.7	78.0	53446	0.86	84.0	429	J	13000	3480	
60		45.00	460	1.15	77.5	52485	0.85	85.4	92.5	64118	0.87	86.0	592	K	13000	3500	
75		55.00	460	1.15	101.0	65182	0.81	85.8	112.0	77635	0.87	86.0	650	J	13000	3500	
100		75.00	460	1.15	126.0	86335	0.86	86.6	150.0	105170	0.88	87.0	855	J	13000	3500	
125		92.00	460	1.15	155.5	107787	0.87	86.9	184.0	129009	0.88	87.0	1104	J	13000	3480	
150		110.00	460	1.15	186.2	129068	0.87	86.6	220.0	154250	0.88	86.0	1276	J	13000	3480	
40		30.0	575	1.15	43.3	37086	0.86	81.0	49.0	42456	0.87	85.0	202	J	13000	3500	
50		37.0	575	1.15	55.5	46983	0.85	79.0	62.2	53274	0.86	84.0	257	G	13000	3500	
60		45.0	575	1.15	62.0	53720	0.87	84.0	71.0	62226	0.88	85.0	465	J	13000	3500	
75		55.0	575	1.15	79.1	67749	0.86	81.0	89.4	78352	0.88	85.0	586	L	13000	3485	
100		75.0	575	1.15	104.0	91147	0.88	82.0	118.0	104592	0.89	86.0	786	N	13000	3470	
125	92.0	575	1.15	118.4	104947	0.89	88.0	144.0	127638	0.89	86.0	1007	R	13000	3470		
150	110.0	575	1.15	156.0	127399	0.82	86.0	176.0	147238	0.84	89.0	1230	H	13000	3470		
10" three phase 60 Hz motors																	
MMS 10000	175	132.00	460	1.15	226.2	151388	0.84	86.5	265.0	181578	0.86	88.0	1511	J	13000	3510	
	200	147.00	460	1.15	266.4	171924	0.81	86.6	305.0	204126	0.84	87.0	1891	K	13000	3520	
	250	190.00	460	1.15	339.8	213879	0.79	86.7	405.0	264598	0.82	87.0	2471	K	13000	3520	

* Calculated value (voltage x current x Cos F)
 ** Calculated value (full load current x locked rotor current %)

8. Approvals

Product	Approval		
SP 4"			
SP 4" pump end (5S - 77S)		 CLASSIFIED C UL US WATER QUALITY Drinking Water System Component NSF/ANSI 61 MH26400 NSF/ANSI 372	
MS 6000C motor		 CLASSIFIED C UL US Submersible Motor NSF/ANSI 372 MH26400	
MS 4000 motor		IAPMO File 6591 0.25 % lead	
MS 402 motor			IAPMO File 6591 0.25 % lead

Grundfos SP pumps are certified when driven by a certified motor provided with suitable overheating protection.

9. Accessories

Grundfos RSI (Renewable Solar Inverter)

Grundfos RSI is an off-grid solar inverter that converts the DC power output from a solar panel to AC power supply for pump operation.

RSI is designed for continuous as well as intermittent operation. The system is suitable for various water supply systems including irrigation.

The RSI can be used in existing systems with submersible pumps or dry-installed pumps, thus providing a very wide range of applications allowing you to leverage renewable energy sources with the ability to back up the system with grid or generator power.

RSI features:

- Weatherproof (enclosure class IP66).
- Setup wizard.
- Can operate without the detachable, magnetic control panel.
- AC/DC* compatibility for connecting to the grid or use as a generator as back-up power during solar panel disruptions.
- Maximum power point tracking (MPPT) optimizes available solar irradiation and environmental conditions.
- Overvoltage and undervoltage protection.
- Overload protection.
- Overcurrent protection.
- Overtemperature protection**.
- No-load protection.
- Operating history memory.



TM06 8226 4816

Fig. 19 Grundfos RSI

System components

An RSI system consists of a three-phase Grundfos motor, an RSI solar inverter, and other components such as:

- circuit breaker, AC (optional)
- circuit breaker, DC
- surge protection, DC
- solar panel
- dry-running switch
- level switch (optional)
- sine-wave filter (optional)
- combiner box (junction box).

Pump requirements:

- 50 or 60 Hz
- 3 x 380-440 VAC or 3 x 220 VAC.

As standard, Grundfos three-phase pumps can only be operated via an AC voltage supply. Therefore, the solar panels must not be connected directly to the pump but must be connected via an RSI.

* Solar power (DC) and AC power must never under any circumstances be connected at the same time.

** The inverter does not detect motor temperature or protect the motor against overtemperature.

Technical data

Voltage			3 x 208-240 V	3 x 380-440 V
Installation environment	Minimum ambient temperature	[°F (°C)]	14 (-10)	14 (-10)
	Maximum ambient temperature	[°F (°C)]	140 (60)	140 (60)
	Maximum relative humidity	[%]	100	100
Electrical data	DC minimum MPP voltage	[VDC]	230	400
	DC recommended MPP voltage	[VDC]	290-336	530-615
	DC maximum input voltage	[VDC]	380	800
	AC input voltage	[VAC]	208-240	380-460
	AC rated output voltage	[VAC]	220	380-440
	Minimum frequency	[Hz]	5	5
	Maximum frequency	[Hz]	60	60
	Phases		3	3
	Enclosure class		IP66	IP66

Low voltage range (3 x 208-240 V)

Power [kW]	Product number	Electrical data			Frame size
		Max. P2 [Hp]	Max. P2 [kW]	Rated output current [Amps]	
1.5	99090622	2	1.5	8	A
2.2	99090633	3	2.2	11	A
3	99090634	4	3.0	12.5	A
4	99090635	5	4.0	18	B
5.5	99090636	7.5	5.5	24.2	B
7.5	99090637	10	7.5	31	B
11	99090638	15	11	48	C
15	99090639	20	15	62	C

High voltage range (3 x 380-440 V)

Power [kW]	Product number	Electrical data			Frame size
		Max. P2 [Hp]	Max. P2 [kW]	Rated output current [Amps]	
2.2	99044348	3	2.2	5.6	A
3.0	99044349	4	3.0	8	A
4.0	99044350	5	4.0	9.6	A
5.5	99044351	7.5	5.5	12	A
7.5	99044352	10	7.5	16	B
11	99044363	15	11	23	B
15	99044364	20	15	31	B
18.5	99044365	25	18.5	38	C
22	99044366	30	22	46	C
30	99044367	40	30	61	C
37	99044368	50	37	72	C

Optional

CU331SP variable frequency drive

Description	Product number
Combiner box (junction box) components kit, DC	98298572
Circuit breaker, DC	98341686
Surge protection, DC	98341687

CU331SP constant pressure drive kits (with sensor)

Enclosure type	NEMA	Hp	Input Ph	Input volts	Product number	Approximate ship wt. [lb]
Indoor	Type 12	2	1	200 - 240	98370277	60
		3	1	200 - 240	98370280	60
		5	1	200 - 240	98370304	60
Outdoor	Type 4X	2	1	200 - 240	98370279	60
		3	1	200 - 240	98370301	60
		5	1	200 - 240	98370305	60



TM05 5801 4012

Fig. 20 CU331SP variable frequency drive and sensor

Features

User interface

The user interface offers these possibilities:

- Local operation via a operating panel with graphic display where the menu structure is based on the well-known system from Grundfos E-pumps.
- Monitoring of operating status via indicator lights and signal relays.
- Display of alarm or warning and logging of the last five alarms and warnings.

Functions

Control mode: Constant pressure

CU331SP has only one control mode, Constant pressure. The pressure is kept constant, independently of the flow rate.

Startup guide

CU331SP has a startup guide, which is launched at the first power up. Parameters are set manually on the basis of the installation. The startup guide can be repeated, if necessary.

Thanks to the startup guide, the installer can quickly set a few parameters and put CU331SP into operation.

Direction of rotation test

During startup, CU331SP automatically tests and sets the correct direction of rotation without changing the cable connections. The direction of rotation test can be performed manually if it fails for any reason.

Dry-running protection

To protect the pump, CU331SP will automatically set up dry-running protection so that water shortage can be detected. The dry-running alarm will automatically reset 30 minutes after the alarm is declared.

Low-flow stop function

The low-flow stop function is used for changing between on/off operation at low flow rate and continuous operation at high flow rate.

The low-flow stop function protects the pump and saves energy.

Applications

For 4" or larger wells. Main applications:

- Domestic and light commercial water supply
- irrigation
- livestock watering
- water transfer.

System components

- Compact, efficient, and reliable variable frequency drive
- rugged stainless steel pump end and proven, reliable, three-phase motor
- pressure sensor
- diaphragm tank (sold separately).

CU331SP identification

Nameplate

CU331SP can be identified by means of the nameplate. An example is shown below.

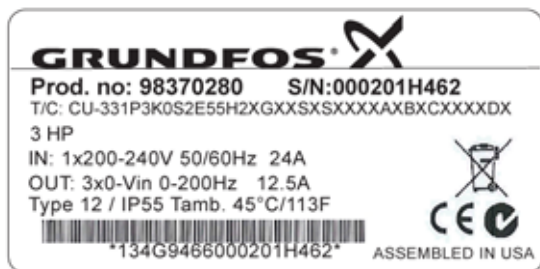

TM05 6001 4012

Fig. 21 Example of nameplate

Key	
Text	Description
T/C:	CU-331 (product name)
Prod. no:	Product number (98370280)
S/N:	Serial number (000201H462) The last four digits indicate the production date. In this case, 46 is the week, and 2 is the year 2012.
3.0 hp	Typical shaft power on the motor
IN:	Supply voltage, frequency and maximum input current.
OUT:	Motor voltage, frequency and maximum output current. The maximum output frequency usually depends on the pump type.
Type 12 / IP55	Enclosure class
Tamb.	Maximum ambient temperature

CU331SP performance range

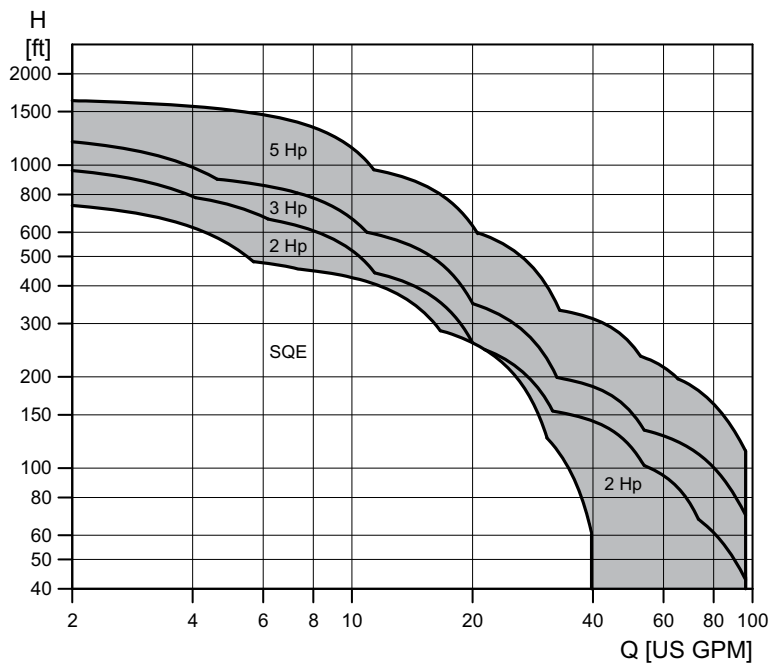

TM05 6380 5012

CU331SP sizing

Step 1

Calculate maximum head requirements at rated flow rate conditions:

$$H_{max} = \text{dynamic head} + \text{system psi (in feet)} + \text{friction loss} + \text{above grade elevation.}$$

Step 2

Select pump from performance curves as follows:

Select a model in which the calculated value of H_{max} is within the maximum performance curve of the pump. Refer to section [CU331SP curve charts](#) on page 126.

Step 3

Select the CU331SP that corresponds to the correct motor Hp and enclosure type.

CU331SP product range

Enclosure type	NEMA	Hp	Input Ph	Input volts
Indoor	Type 12	2	1	200 - 240
		3	1	200 - 240
		5	1	200 - 240
Outdoor	Type 4X	2	1	200 - 240
		3	1	200 - 240
		5	1	200 - 240

CU331SP operation

Menu structure

CU331SP has a startup guide, which is launched at the first power up. After the startup guide, CU331SP has a menu structure divided into four main menus:

0. **GENERAL** gives access to the startup guide for the general setting of CU331SP.
1. **OPERATION** enables the setting of setpoint and resetting of alarms. It is also possible to see the latest five warnings and alarms.
2. **STATUS** shows the status of CU331SP and the pump. It is not possible to change or set values.
3. **INSTALLATION** gives access to available parameters.

CU331SP menu overview

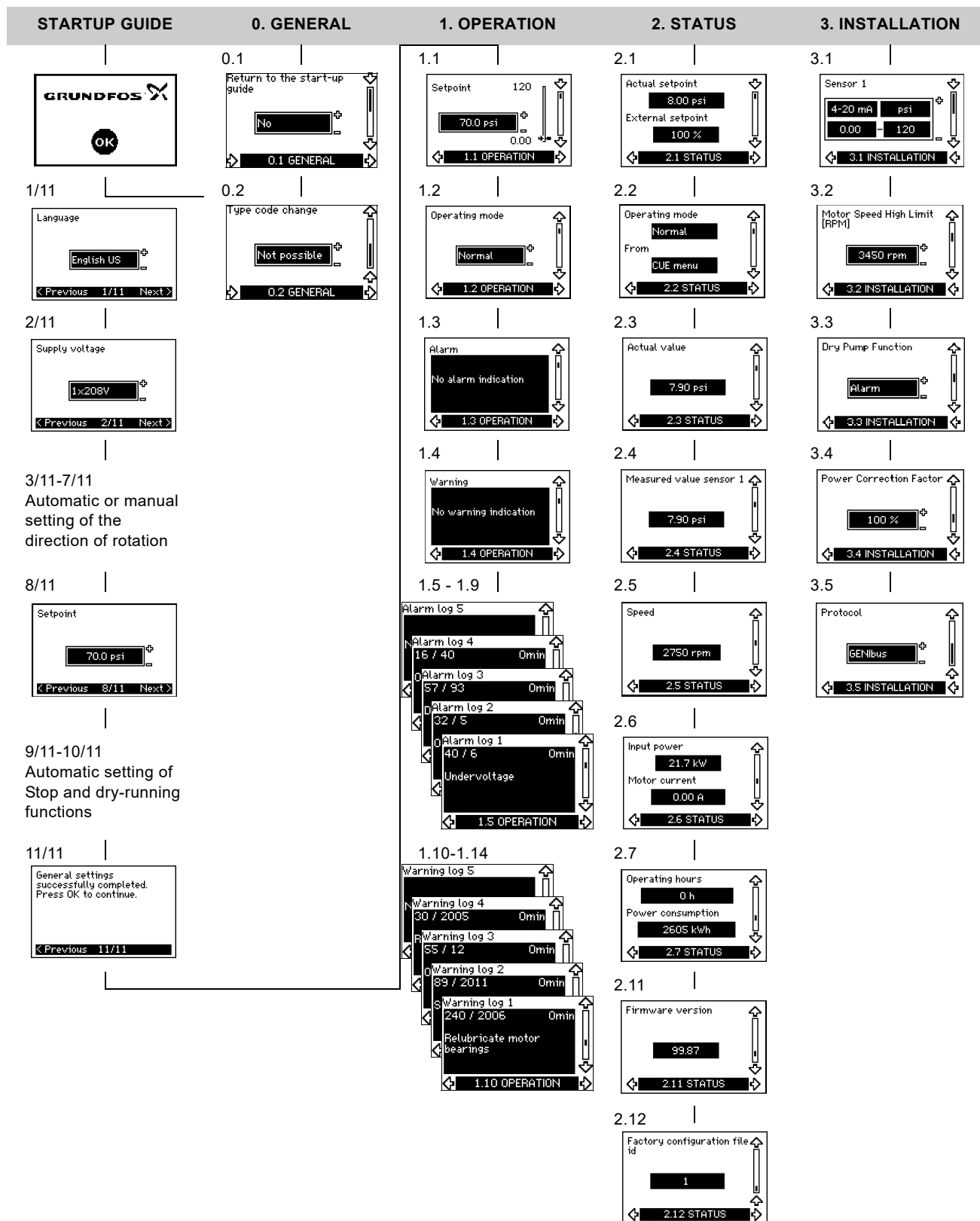

Fig. 22 Menu overview

Operating modes

These operating modes can be selected with CU331SP:

- Normal
- Stop
- Minimum
- Maximum

You can set the operating modes without changing the setpoint setting.

Normal

The pump operates in constant pressure mode.

Stop

The pump has been stopped by user.

Minimum curve

The pump is running at a set minimum speed value. See fig. 23.

For instance, this operating mode can be used during periods with a very small flow requirement.

Maximum curve

The pump is running at a set maximum speed value.

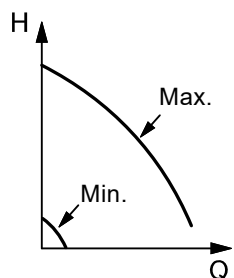

Fig. 23 Minimum and maximum curves

Control mode

CU331SP has been developed specifically to operate submersible pumps in constant pressure mode. This closed-loop control mode uses an analog pressure transducer to provide pressure feedback to the drive.

Constant pressure with stop function

The outlet pressure is kept constant at high flow rate ($Q > Q_{min}$). On/off operation at low flow rate. See fig. 24.

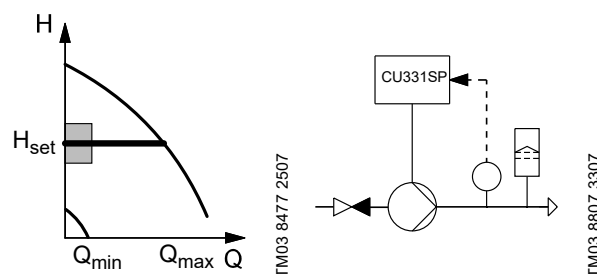

Fig. 24 Constant pressure with stop function

The pump is controlled according to a constant pressure measured after the pump. This means that the pump offers a constant pressure in the Q_{min} to Q_{max} , represented by the horizontal line in the QH diagram.

Setting the setpoint by means of the "OPERATION" menu

The setpoint can be set or changed during operation using the setpoint display in the "OPERATION" menu shown below. It is not necessary to run the startup guide to change the setpoint.

Low flow and stop functions

The pump will check the flow regularly by reducing the speed for a short time. If there is no or only a small change in pressure, this means that there is low flow.

The speed will be increased until the stop pressure (actual setpoint + $0.5 \times \Delta H$) is reached and the pump will stop after a few moments. The pump will restart at the latest when the pressure has fallen to the start pressure (actual setpoint - $0.5 \times \Delta H$).

TM03 8813 2507

TM03 8477 2507

TM03 8807 3307

Operating conditions for the stop function

It is only possible to use the stop function if the system incorporates a pressure sensor, a check valve and a diaphragm tank.

The check valve must always be installed before the pressure sensor.

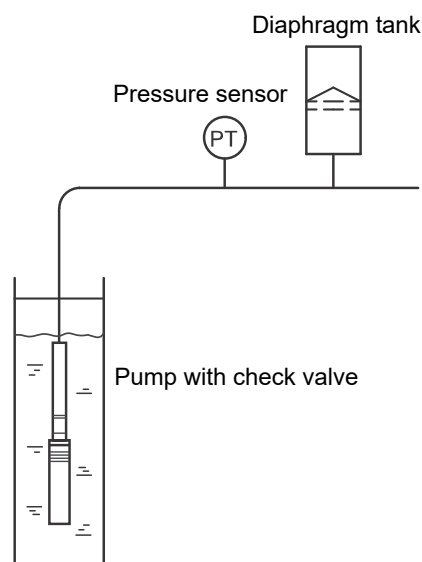

Fig. 25 Position of the pressure sensor and diaphragm tank

Diaphragm tank

The stop function requires a diaphragm tank of a certain minimum size. The tank must be installed as close as possible after the pump and the precharge pressure must be 0.7 x actual setpoint.

Recommended diaphragm tank size:

Rated flow rate of pump [gpm (m ³ /h)]	Minimum diaphragm tank size [gal (l)]
0-26 (0-6)	2 (8)
27-105 (7-24)	4.4 (18)
106-176 (25-40)	14 (50)
177-308 (41-70)	34 (120)
309-440 (71-100)	62 (180)

If a diaphragm tank of the above size is installed in the system, the factory setting of ΔH is the correct setting. If the tank installed is too small, the pump will start and stop too often.

Setting the direction of rotation

The startup guide is started the first time CU331SP is connected to supply voltage. Then while going through the startup guide, CU331SP tests and sets the correct direction of rotation without changing the cable connections to the motor.

The correct direction of rotation can be set in these ways:

- automatic setting.
- manual setting when the direction of rotation is not visible.

Automatic setting

CU331SP automatically tests and sets the correct direction of rotation without changing the cable connections.

Automatic setting requires a sensor.

This test is not suitable for all pump types and will in certain cases not be able to determine for certainty the correct direction of rotation. In these cases, CU331SP changes over to manual setting where the direction of rotation is determined on the basis of the installer's observations.

Manual setting when the direction of rotation is not visible

The correct direction of rotation is set manually without changing the cable connections. This requires that it is possible to observe the head or flow rate.

Status functions

CU331SP shows the following data:

- power consumption
- operating hours
- measured value
- speed
- input power
- motor current.

The status information can be shown in the display.

Power consumption

The value of the power consumption is an accumulated value calculated from the pump's startup date and cannot be reset. No additional sensor is required.

TM05 5804 4012

Operating hours

The value of operating hours is an accumulated value calculated from the pump's startup date and cannot be reset. No additional sensor is required.

Measured value

The sensor display will show the actual pressure as received from the pressure transducer.

Speed

The display will show the motor speed in RPM's (calculated).

Input power

The display will show the power consumption in kW.

Motor current

The display will show the actual motor current being used.

Logging functions

Alarm and warning log

The latest five alarms and five warnings are logged with a timestamp corresponding to the power-on time after the fault has occurred. The alarm and warning log can be shown directly on the display.

See section [Warning and alarm list](#).

Signal relays

The table shows the function of the signal relays.

Type	Function
Relay 1	<ul style="list-style-type: none"> Pump running
Relay 2	<ul style="list-style-type: none"> Alarm

See also fig. 26.

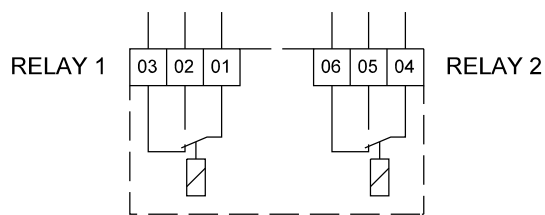

TM03 8801 3407

Fig. 26 Terminals for signal relays (normal state, not activated)

Terminal		Function
C1	C2	Common
NO 1	NO 2	Normally open contact
NC1	NC2	Normally closed contact

CU331SP installation

Mechanical installation

The individual CU331SP cabinet sizes are characterized by their enclosures. The table in section [CU331SP technical data](#) shows the relationship of enclosure class and enclosure type.

Reception and storage

Check on receipt that the packaging is intact, and the unit is complete. In case of damage during transport, contact the transport company to file a claim.

Note that CU331SP is delivered in a packaging which is not suitable for outdoor storage.

Transportation and unpacking

CU331SP must only be unpacked at the installation site to prevent damage during the transport to the site.

The packaging contains accessory bag(s), documentation and the unit itself. See fig. 27.



Fig. 27 CU331SP packaging

TM05 5990 4012

Space requirements and air circulation

CU331SP units can be mounted side by side, but as a sufficient air circulation is required for cooling these requirements must be met:

- Sufficient free space above and below CU331SP
- Ambient temperature up to 122°F (50 °C)
- Hang CU331SP directly on the wall, or fit it with a back plate. See fig. 28.

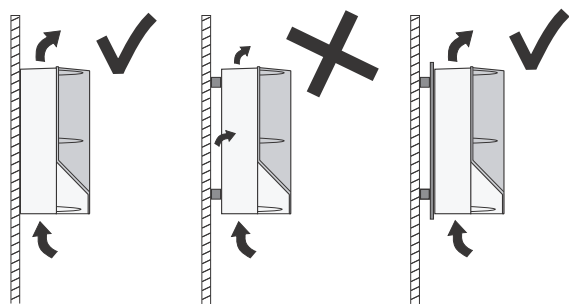

TM03 8859 2607

Fig. 28 CU331SP hung directly on the wall or fitted with a back plate

Required free space above and below CU331SP:

Enclosure	Space [in (mm)]
B1	7.9 (200)

For information about enclosure, see section [Enclosure](#).

Mounting

CU331SP must be mounted securely on a firm surface. Ensure that screws are sized appropriately for the weight of CU331SP (approximately 60 lbs) and anchored securely to the mounting surface.

1. Mark and drill holes. See fig. 29; also see section [Main dimensions and weight](#).
2. Fit the screws, but leave loose. Mount CU331SP, and tighten the four screws.

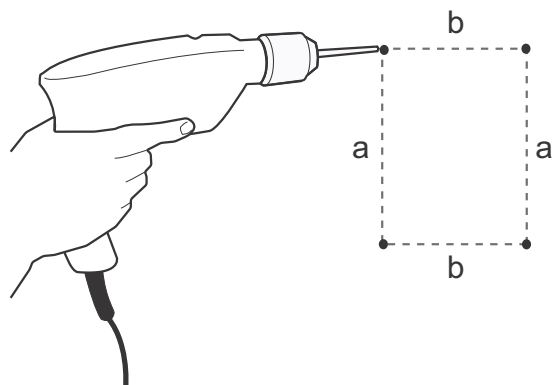

TM03 8860 2607

Fig. 29 Drilling holes for mounting

CU331SP electrical connection

Ensure the correct grounding and protection procedures are used for the installation. Before the electrical installation, ensure that the power supply and other voltage inputs are switched off.

Electrical protection

Protection against electric shock, indirect contact

The leakage current to ground exceeds 3.5 mA, and a reinforced ground connection is required.

Protective conductors must always have a yellow and green (PE) or yellow and green and blue (PEN) color marking.

Instructions according to EN IEC 61800-5-1:

- CU331SP must be stationary, installed permanently and connected permanently to the mains supply.
- The ground connection must be carried out with duplicate protective conductors or with a single reinforced protective conductor with a cross-section of minimum AWG 7 (10 mm²).

Protection against short-circuit, fuses

CU331SP and the supply system must be protected against short-circuit.

Grundfos requires that the backup fuses are used for protection against short-circuit.

CU331SP offers complete short-circuit protection in case of a short-circuit on the motor output.

Additional protection

The leakage current to ground exceeds 3.5 mA.

We recommend to connect CU331SP to an electrical installation where a Ground Fault Circuit Interrupter (GFCI) type B is used as additional protection. The total leakage current of all the electrical equipment in the installation must be taken into account.

During startup and in asymmetrical supply systems, the leakage current can be higher than normal and may cause the GFCI to trip.

Motor protection

The motor requires no external motor protection. CU331SP protects the motor against thermal overloading and blocking.

Protection against overcurrent

CU331SP has an internal overcurrent protection for overload protection on the motor output.

Protection against mains voltage transients

CU331SP is protected against mains voltage transients.

Mains and motor connection

The supply voltage and frequency are marked on the CU331SP nameplate. Make sure that CU331SP is suitable for the power supply of the installation site.

The maximum output voltage of CU331SP is equal to the input.

Example: if the supply voltage is rated at 208V choose a 208V motor for operation.

Main switch

A main switch can be installed before CU331SP according to local regulations. See fig. 30.

Wiring diagram

The wires in the terminal box must be as short as possible. Excepted from this is the ground wire, which must be so long that it is the last one to be disconnected in case the cable is inadvertently pulled out of the cable entry.

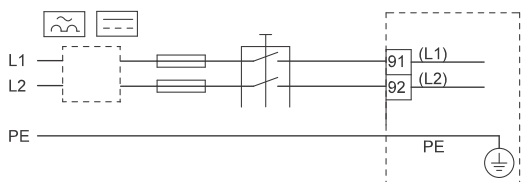

TM05 5867 3912

Fig. 30 CU331SP wiring diagram

Terminal	Function
91 (L1)	Single-phase supply
92 (L2)	
95/99 (PE)	Ground connection

For single-phase connection, use L1 and L2.

Mains connection

Check that mains voltage and frequency correspond to the values on the nameplate of CU331SP and the motor.

1. Connect the ground wire to terminal 95 (PE). See fig. 31.
2. Connect the power leads to the terminals 91 (L1), 92 (L2).
3. Fix the mains cable with a cable clamp.

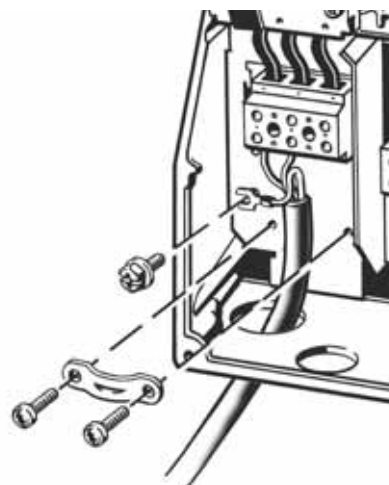

Fig. 31 Mains connection

CU331SP drive is usable with three-phase input power by connecting leads to 91 (L1), 92 (L2), and 93 (L3).

Motor connection

The motor cable must be screened for CU331SP to meet EMC requirements.

1. Connect the ground wire to terminal 99 (PE). See fig. 32.
2. Connect the motor leads to the terminals 96 (U), 97 (V), 98 (W).
3. Fix the screened cable with a cable clamp.

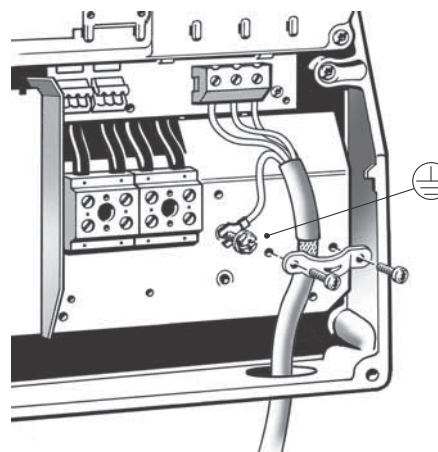

TM03 9020 2807

Fig. 32 Motor connection

The cable screen must be exposed and in physical contact with the mounting plate and clamp

9.1 Connecting the signal terminals

As a precaution, signal cables must be separated from other groups by reinforced insulation in their entire lengths.

If no external on/off switch is connected, short-circuit terminals 18 and 20 using a short wire.

Connect the signal cables according to the guidelines for good practice to ensure EMC-correct installation.

See section [EMC-correct installation](#).

- Use screened signal cables with a conductor cross-section of minimum AWG 20 (0.5 mm²) and maximum AWG 16 (1.5 mm²).
- Use a 3-conductor screened bus cable in new systems.

Minimum connection, signal terminal

Operation is only possible when the terminals 18 and 20 are connected, for instance by means of an external on/off switch or a short wire.

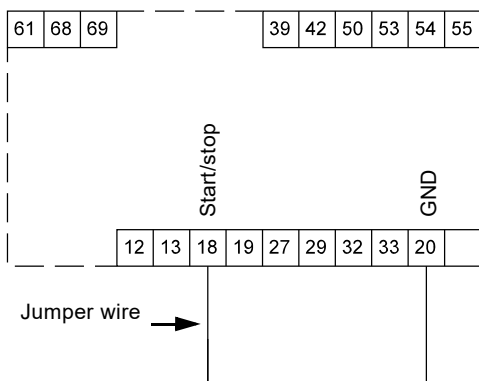

TM03 9057 3207

Fig. 33 Required minimum connection, signal terminal

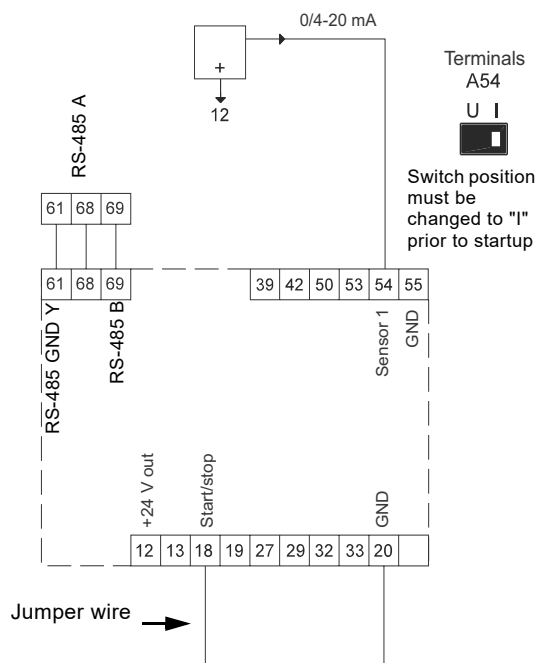

TM05 5802 3913

Fig. 34 Wiring diagram for CU331SP

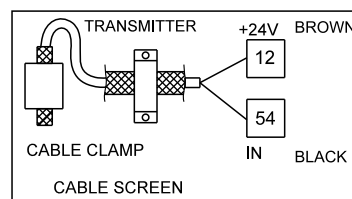

TM05 6776 5112

Fig. 35 Sensor wiring diagram

Setting the analog input 54

The contact A54 is positioned behind the control panel and is used for setting the signal type of the analog input.

The factory setting of the inputs is voltage signal "U". This setting must be changed to "I" prior to starting CU331SP. Be sure the power supply is switched off.

Remove the control panel to set the contact. See fig. 36.

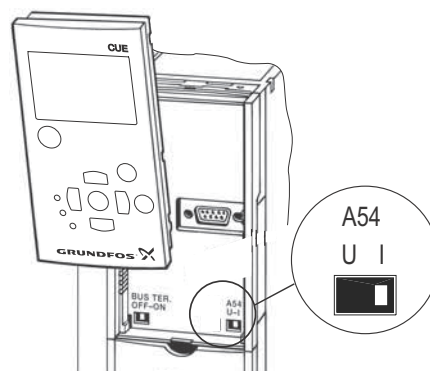

TM05 5803 3912

Fig. 36 Setting contact A54 to current signal "I"

Terminal key

Terminal	Type	Function
12	+24 V out	Supply to sensor
18	DI 1	Digital input, start/stop
20	GND	Common frame for digital inputs
55	GND	Common frame for analog inputs
54	AI 2	Sensor input, sensor 1, 0/4-20 mA
61	RS-485 GND Y	GENIbus, frame
68	RS-485 A	GENIbus, signal A (+)
69	RS-485 B	GENIbus, signal B (-)

The RS-485 screen must be connected to frame.

Access to signal terminals

All signal terminals are behind the terminal cover of CU331SP front. Remove the terminal cover as shown in fig. 37.

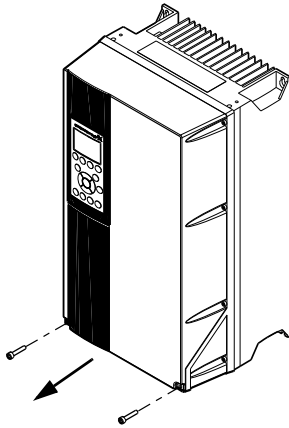

Fig. 37 Access to signal terminals

TM03 9004 2807

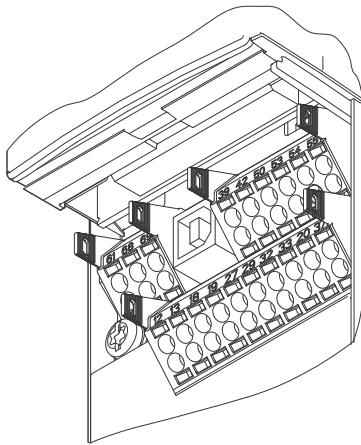

Fig. 38 Signal terminals

TM03 9025 2807

Fitting the conductor

1. Remove the insulation at a length of 0.35 to 0.40 inches (9 to 10 mm).
2. Insert a screwdriver with a tip of maximum 0.015 X 0.1 in (0.4 X 2.5 mm) into the square hole.
3. Insert the conductor into the corresponding round hole. Remove the screwdriver. The conductor is now fixed in the terminal.

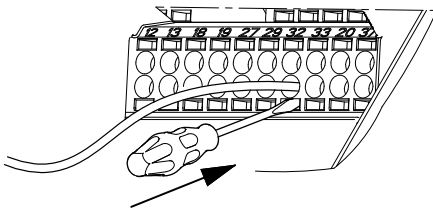
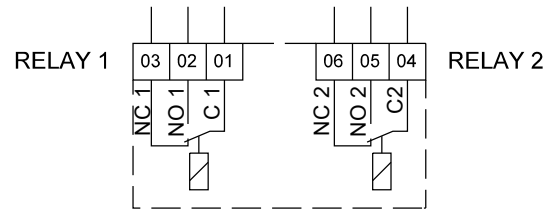

Fig. 39 Fitting the conductor into the signal terminal

TM03 9026 2807

Connecting the signal relays

As a precaution, signal cables must be separated from other groups by reinforced insulation in their entire lengths.



TM03 8801 2507

Fig. 40 Terminals for signal relays (normal state, not activated)

Terminal	Function
C 1 C 2	Common
NO 1 NO 2	Normally open contact
NC 1 NC 2	Normally closed contact

Signal relay

The signal relays on CU331SP are predefined as follows:

- Relay 1: Pump running
- Relay 2: Alarm

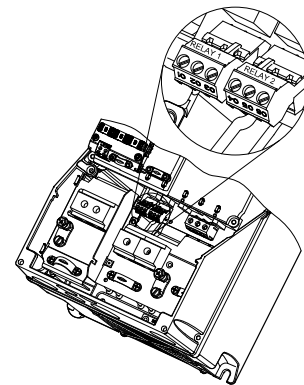

Fig. 41 Terminals for relay connection

TM03 9008 2807

EMC-correct installation

This section gives guidelines for good practice when installing CU331SP. Follow these guidelines to meet EN 61800-3, first environment.

- Use only motor and signal cables with a braided metal screen in applications without output filter.
- There are no special requirements to supply cables, apart from local requirements.
- Leave the screen as close to the connecting terminals as possible. See fig. 42.
- Avoid terminating the screen by twisting the ends. See fig. 43. Use cable clamps or EMC screwed cable entries instead.
- Connect the screen to frame at both ends for both motor and signal cables. If the controller has no cable clamps, connect only the screen to CU331SP.
- Avoid unscreened motor and signal cables in electrical cabinets with variable frequency drives.
- Make the motor cable as short as possible in applications without output filter to limit the noise level and minimize leakage currents.
- Screws for frame connections must always be tightened whether a cable is connected or not.
- Keep main cables, motor cables and signal cables separated in the installation, if possible.

Other installation methods may give similar EMC results if the above guidelines for good practice are followed.

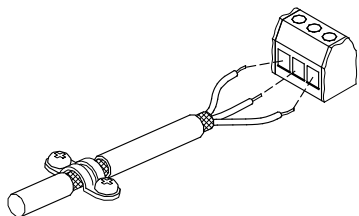

Fig. 42 Example of stripped cable with screen

TM02 1325 0901

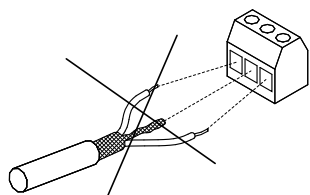

Fig. 43 Do not twist the screen ends

TM03 8812 2507

Line disturbance and transient protection

To protect itself from AC line voltage disturbances, CU331SP monitors the input power supply and interrupts drive operation in the event of phase loss or imbalance. Transients on the AC line are suppressed by MOVs as well as zener diodes for extreme transients. CU331SP meets VDE 0160 (European standard - 2.3 x line voltage for 1.3 msec) for transient protection.

RFI filters

To meet the EMC requirements, CU331SP comes with the following types of built-in radio frequency interference filter (RFI).

Voltage	Typical shaft power P2	RFI filter type
1 x 200-240 V *	1.5 - 10 hp	C1

* Single-phase input - three-phase output.

Description of RFI filter types

C1: For use in domestic areas.

RFI filter types are according to EN61800-3.

Control panel

The on/off button on the control panel does not disconnect CU331SP from the power supply and must therefore not be used as a safety switch.

 The On/Off button has the highest priority. In "Off" condition, pump operation is not possible.

The control panel is used for local setting of CU331SP. The functions available are preset in CU331SP.

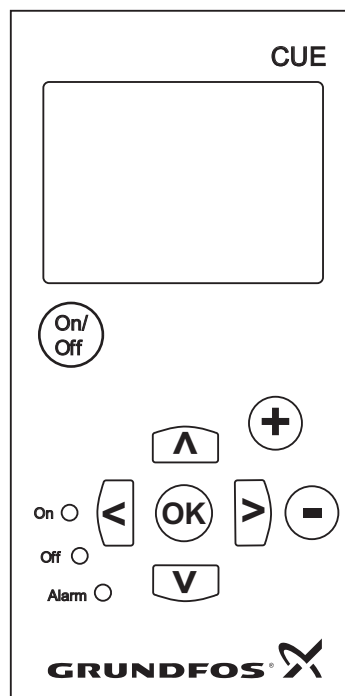









Fig. 44 Control panel of CU331SP

TM03 8719 2507

Editing buttons

Button	Function
	With this button you can start and stop the pump and ake it ready for operation.
	With this button you can save changed values, resets alarms and expands the value field.
	These buttons change values in the value field.

Navigating buttons

Button	Function
 	With these buttons you can navigate from one menu to another. When the menu is changed, the display shown will always be the top display of the new menu.
 	With these buttons you can navigate up and down in the individual menu.

Adjusting the display contrast

Press OK and + for darker display.

Press OK and - for brighter display.

Button lock

To lock the buttons on the panel press and hold the up and down arrows simultaneously.

Indicator lights

The operating condition of the pump is indicated by the indicator lights on the front of the control panel. See fig. 44.

The table shows the function of the indicator lights.

Indicator light	Function
On (green)	The pump is running or has been stopped by a stop function. If flashing, the pump has been stopped by the user (CU331SP menu), external start/stop or bus.
Off (orange)	The pump has been stopped with the on/off button.
Alarm (red)	Indicates an alarm or a warning.

Displays, general terms

Figures 45 and 46 show the general terms of the display.

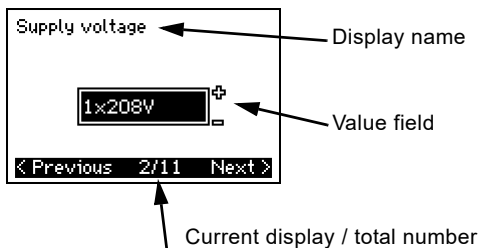

Fig. 45 Example of display in the startup guide

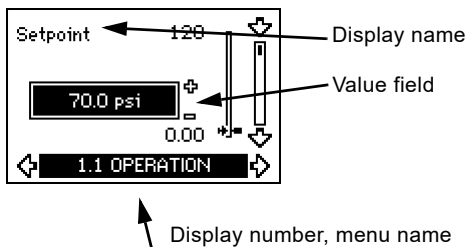

Fig. 46 Example of display in the user menu

Warning and alarm list

Code and display text	Status			Operating mode	Resetting
	Warning	Alarm	Locked alarm		
1 Too high leakage current			•	Stop	Man.
2 Mains phase failure		•		Stop	Aut.
3 External fault		•		Stop	Man.
16 Other fault		•		Stop	Aut.
32 Overvoltage	•			-	Aut.
40 Undervoltage	•			Stop	Aut.
48 Overload		•		Stop	Aut.
49 Overload		•	•	Stop	Man.
55 Overload	•			-	Aut.
57 Dry running		•		Stop	Aut.
64 Too high CU331SP temperature		•		Stop	Aut.
89 Sensor 1 outside range		•		1)	Aut.
96 Setpoint signal outside range		•		1)	Aut.
155 Inrush fault		•		Stop	Aut.
241 Motor phase failure	•			-	Aut.
		•		Stop	Aut.

1) In case of an alarm, CU331SP will change the operating mode depending on the pump type. Warning is reset in display 3.20.

CU331SP technical data

Enclosure

All CU331SP enclosures are size B1.

The enclosure rating can be either IP 55 / TYPE 12 or IP 66 / TYPE 4X.

Main dimensions and weight

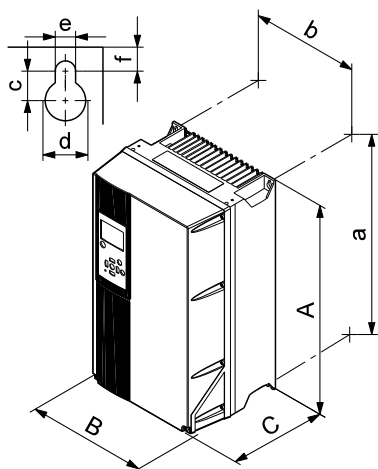

TM03 9002 2807

Fig. 47 Enclosure B1

Note: The dimensions shown for CU331SP enclosures are maximum height, width and depth.

Enclosure	Height [in]		Width [in]		Depth [in]
	A	a	B	b	C
B1	18.9	17.9	9.5	8.3	10.2
	Screw holes [in]				Weight [lbs]
c	d	e	f	50.7	
	0.47	0.75	0.35	0.35	

Surroundings

Relative humidity	5-95 % RH
Ambient temperature	Max. 122 °F (50 °C)
Average ambient temperature over 24 hours	Max. 113 °F (45 °C)
Minimum ambient temperature at full operation	32 °F (0 °C)
Minimum ambient temperature at reduced operation	14 °F (-10 °C)
Temperature during storage and transportation	-13 to 150 °F (-25 to 65 °C)
Storage duration	Max. 6 months
Maximum altitude above sea level without performance reduction	3280 ft (1000 m)
Maximum altitude above sea level with performance reduction	9840 ft (3000 m)

CU331SP comes in a packaging which is not suitable for outdoor storage.

Terminal tightening torques

Enclosure	Tightening torque [ft-lb]			
	Mains	Motor	Earth	Relay
B1	1.3	1.3	2.2	0.4

Cable length

Maximum length, screened motor cable	500 ft (152 m)
Maximum length, unscreened motor cable	1000 ft (305 m)
Maximum length, signal cable	1000 ft (305 m)

Fuses and cable cross-section

Always comply with national and local regulations as to cable cross-sections.

Cable cross-section to signal terminals

Maximum cable cross-section to signal terminals, rigid conductor	AWG 14
Maximum cable cross-section to signal terminals, flexible conductor	AWG 18
Minimum cable cross-section to signal terminals	AWG 20

Non-UL fuses and conductor cross-section to mains and motor

Typical shaft power P2 [Hp]	Maximum fuse size [A]	Fuse type	Maximum conductor cross section ¹	
			[AWG]	[mm ²]
2	40	gG	7	10
3	40	gG	7	10
5	80	gG	7	10

¹⁾ Screened motor cable, unscreened supply cable.

UL fuses and conductor cross-section to mains and motor

Typical shaft power P2 [Hp]	Maximum fuse size [A]	Bussmann RK1	Maximum conductor cross section ¹
			[AWG]
2	40	KTN-R40	7
3	40	KTN-R40	7
5	80	KTN-R80	7

¹⁾ Screened motor cable, unscreened supply cable.

Inputs and outputs

Mains supply (L1, L2)

Supply voltage	200-240 V ± 10 %
Supply frequency	60 Hz
Maximum temporary imbalance between phases	3 % of rated value
Leakage current to earth	> 3.5 mA
Number of cut-ins	Max. 1 time/min.

Do not use the power supply for switching CU331SP on and off.

Motor output (U, V, W)

Output voltage	0-100 % ¹⁾
Output frequency	0-60 Hz
Switching on output	Not recommended

¹⁾ Output voltage in % of supply voltage.

RS-485 GENibus connection

Terminal number	68 (A), 69 (B), 61 GND (Y)
-----------------	----------------------------

The RS-485 circuit is functionally separated from other central circuits and galvanically separated from the supply voltage (PELV).

Digital inputs

Terminal number	18
Voltage level	0-24 VDC
Voltage level, open contact	> 19 VDC
Voltage level, closed contact	< 14 VDC
Maximum voltage on input	28 VDC
Input resistance, R_i	Approx. 4 k Ω

All digital inputs are galvanically separated from the supply voltage (PELV) and other high-voltage terminals.

Signal relays

Relay 01 , terminal number	1 (C), 2 (NO), 3 (NC)
Relay 02 , terminal number	4 (C), 5 (NO), 6 (NC)
Maximum terminal load (AC-1) ¹⁾	240 VAC, 2 A
Maximum terminal load (AC-15) ¹⁾	240 VAC, 0.2 A
Maximum terminal load (DC-1) ¹⁾	50 VDC, 1 A
Minimum terminal load	24 V DC 10 mA 24 V AC 20 mA

¹⁾ IEC 60947, parts 4 and 5.

- C Common
- NO Normally open
- NC Normally closed

The relay contacts are galvanically separated from other circuits by reinforced insulation (PELV).

Analog input

Terminal number	54
Current signal	A54 = "I" ¹⁾
Current range	0-20, 4-20 mA
Input resistance, R_i	Approx. 200 Ω
Maximum current	30 mA
Maximum fault, terminals 53, 54	0.5 % of full scale

¹⁾ The factory setting is voltage signal "U".

All analog inputs are galvanically separated from the supply voltage (PELV) and other high-voltage terminals.

Sound pressure level

The sound pressure of CU331SP is maximum 70 dB(A).

The sound pressure level of a motor controlled by a variable frequency drive may be higher than that of a corresponding motor which is not controlled by a variable frequency drive.

CU331SP curve charts

CU331SP, 2 Hp

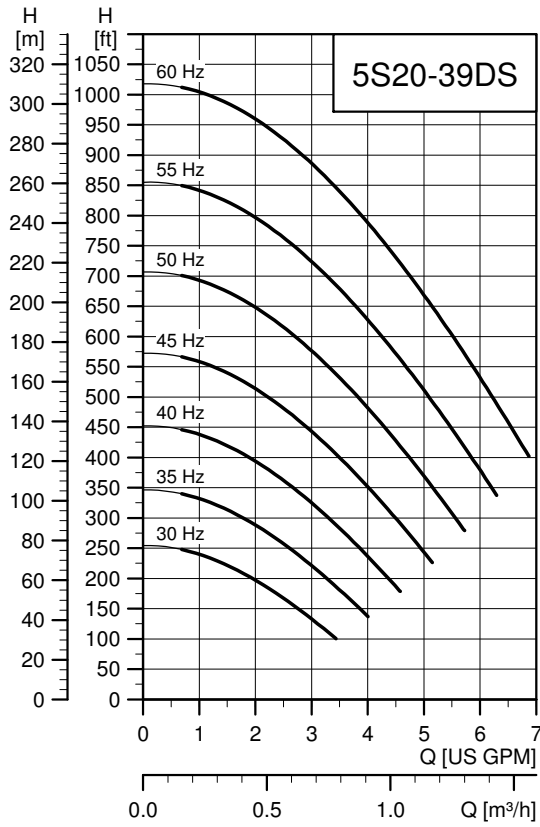

TM05 6410 5012

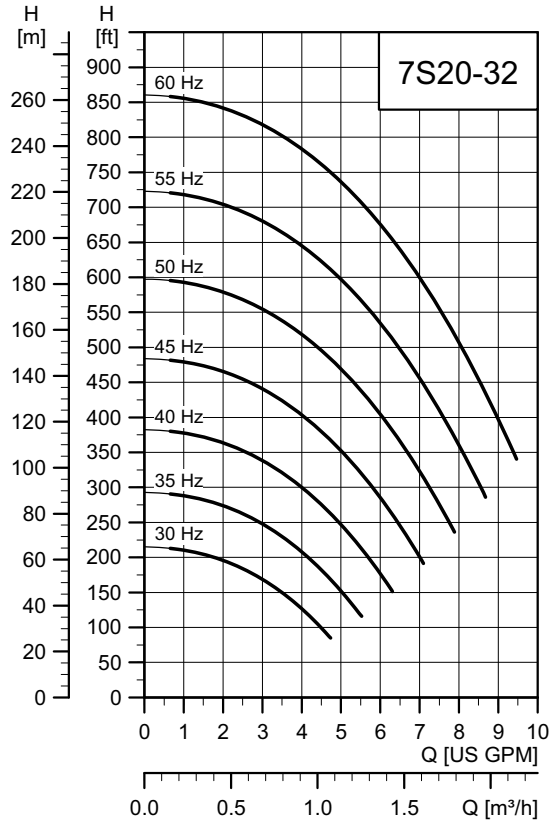

TM05 6411 5012

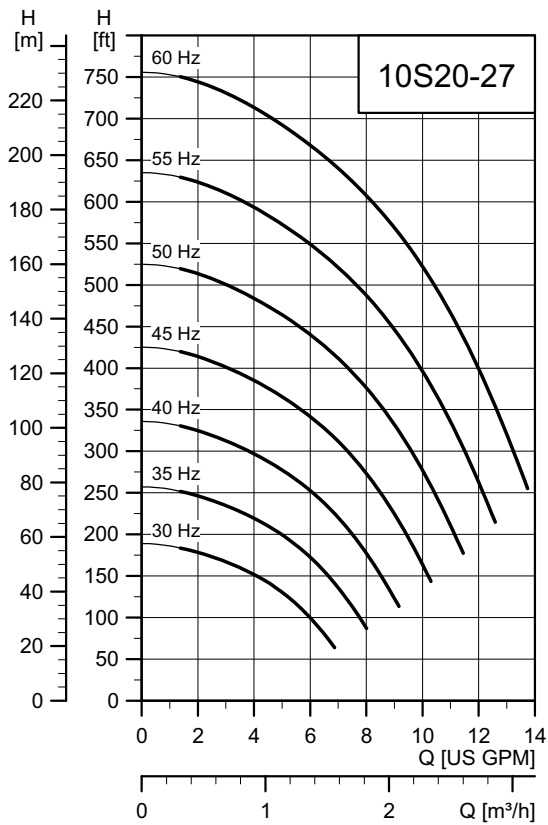

TM05 6412 5012

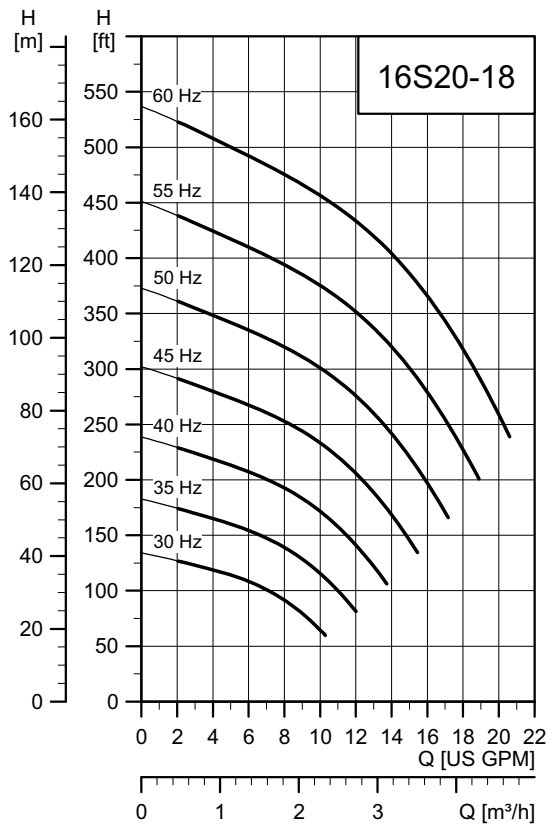

TM05 6413 5012

CU331SP, 2 Hp, continued

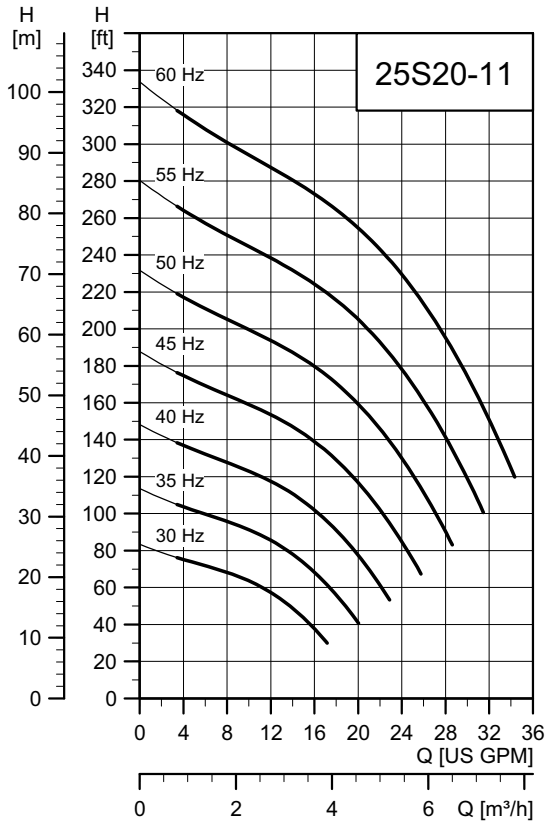

TM05 6414 5012

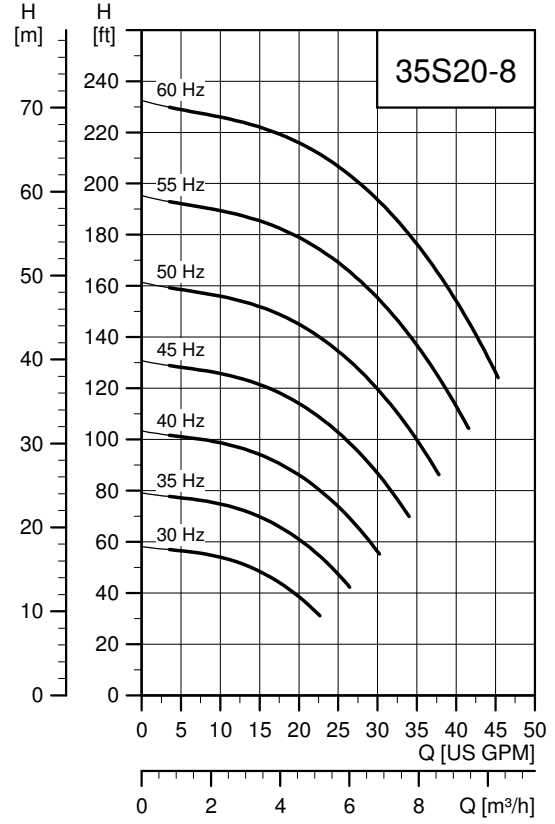

TM06 9747 3217

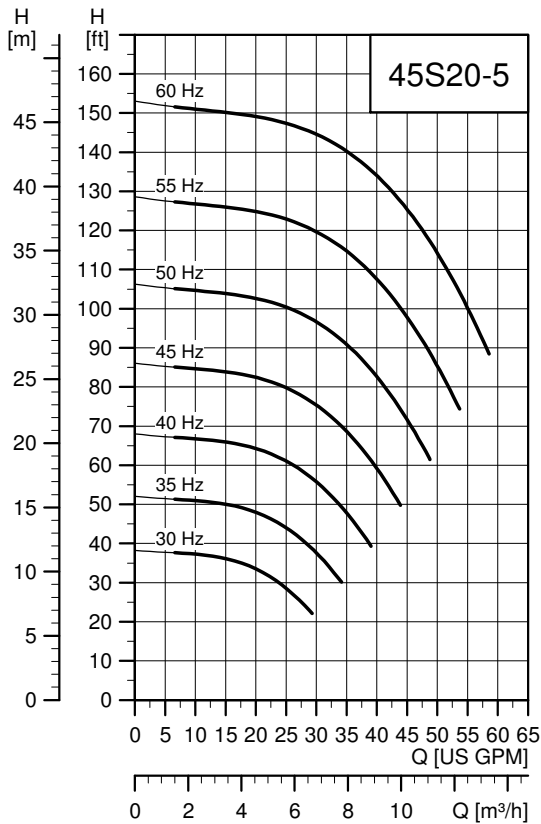

TM06 9751 3217

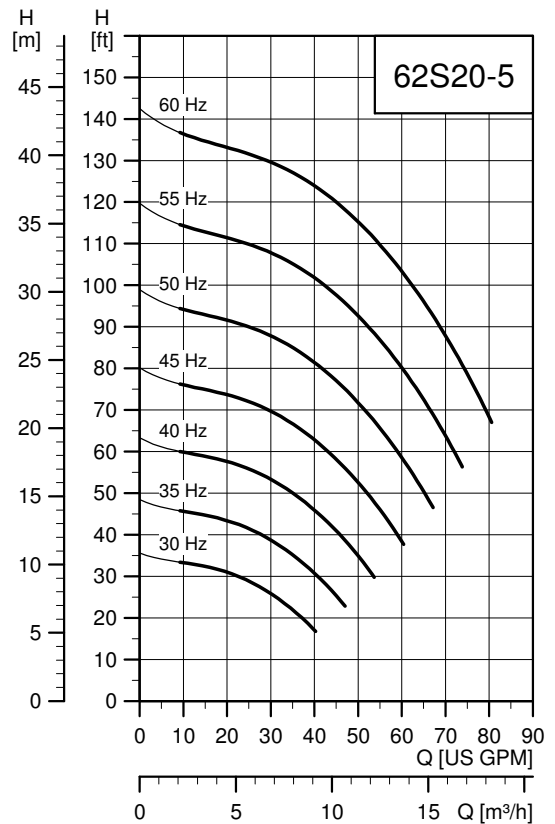

TM06 9759 3217

CU331SP, 2 Hp, continued

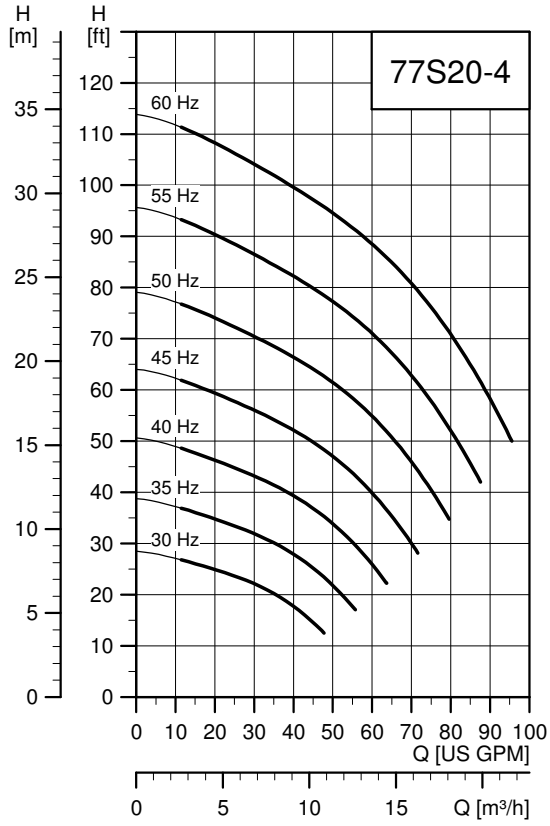

TM06 9755 3217

CU331SP, 3 Hp

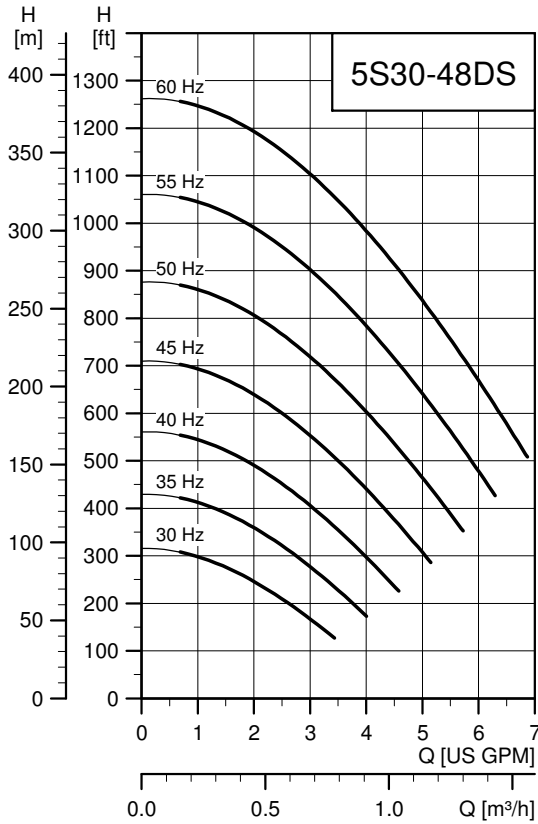

TM05 6418 5012

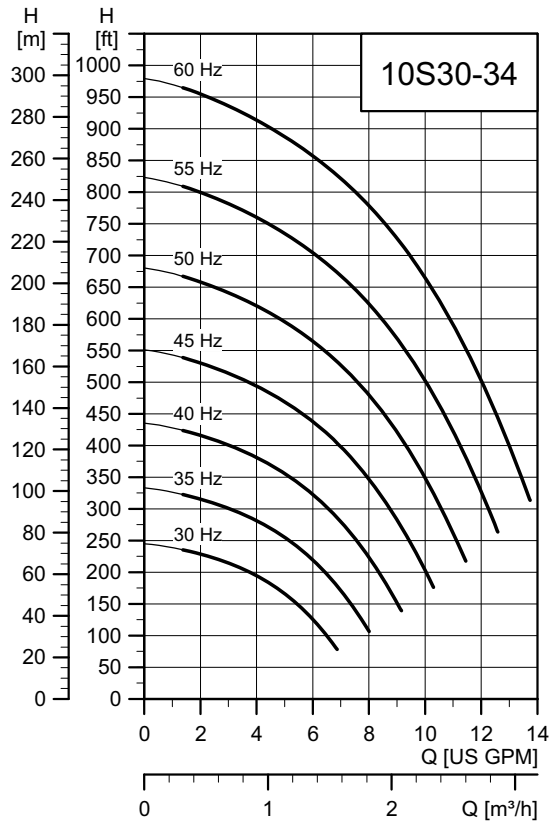

TM05 6419 5012

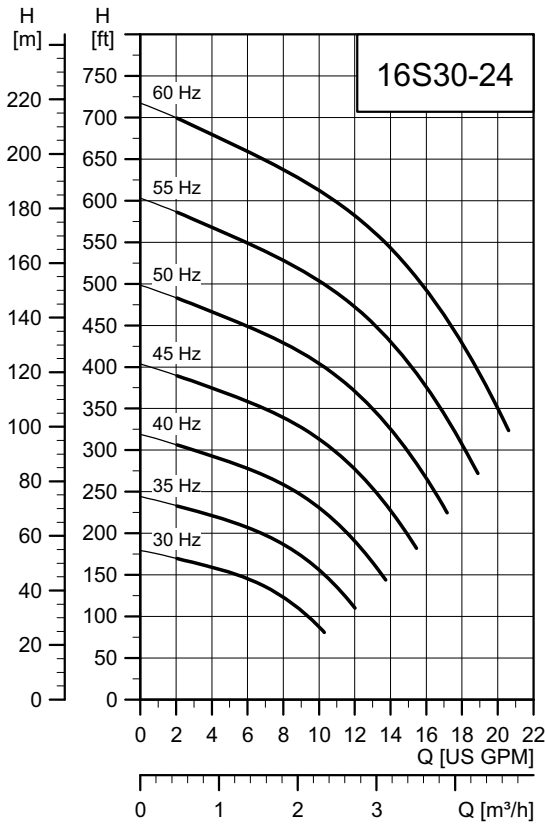

TM05 6420 5012

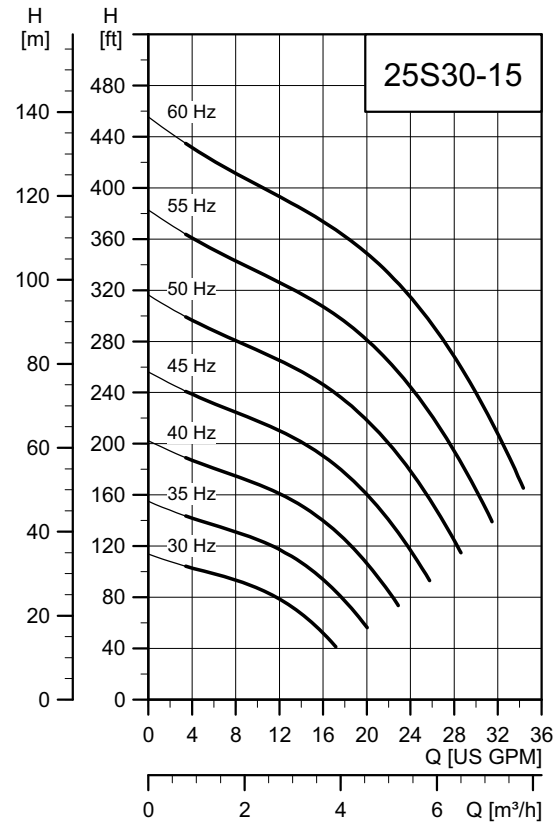

TM05 6421 5012

CU331SP, 3 Hp, continued

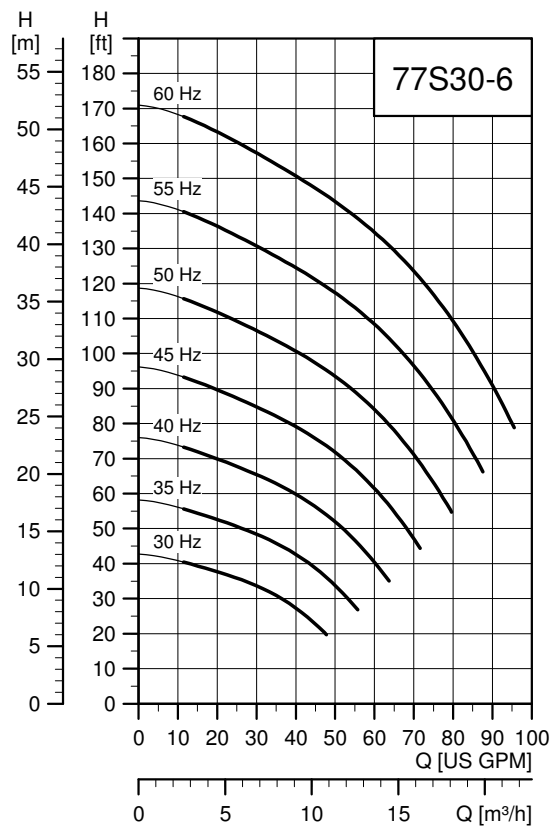
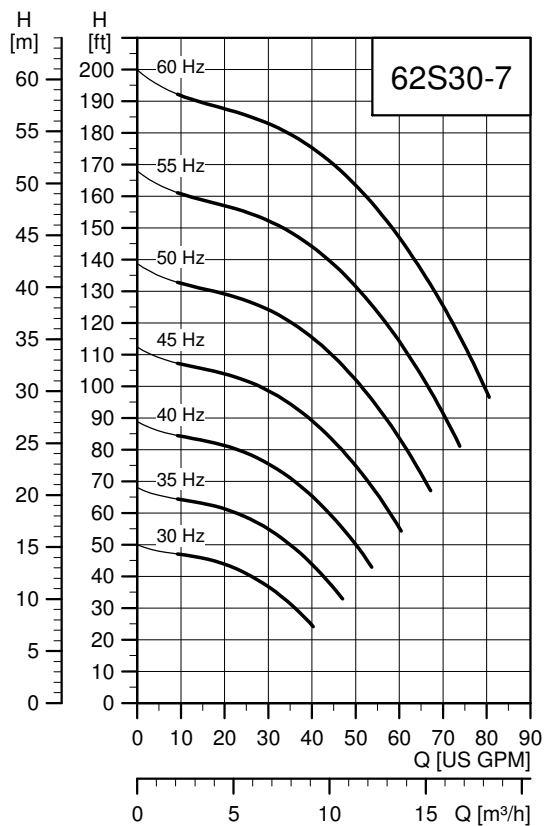
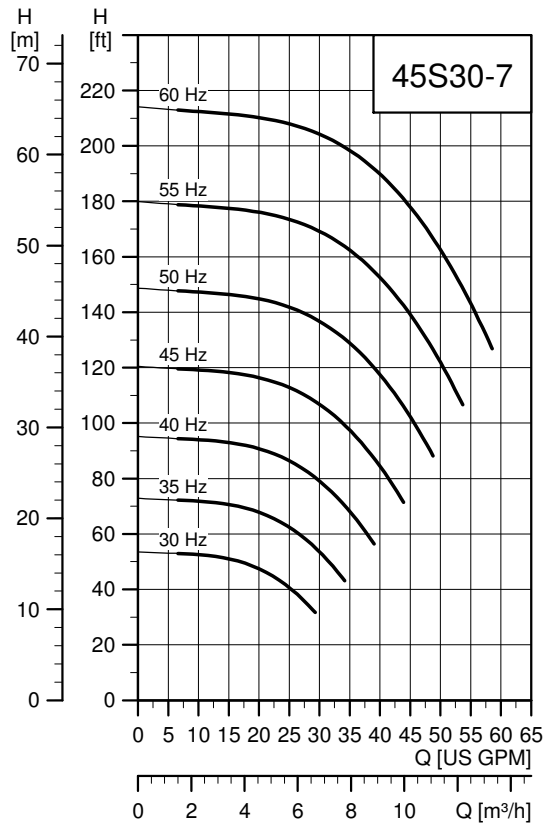
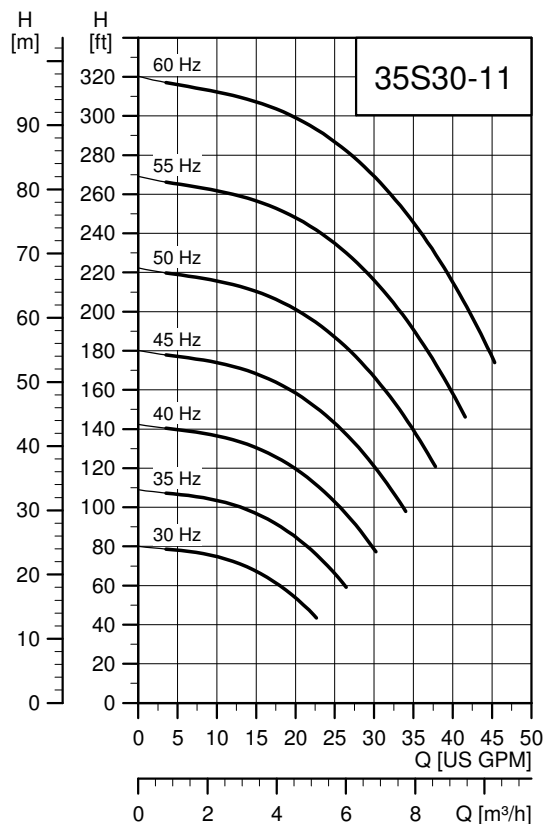

CU331SP, 5 Hp

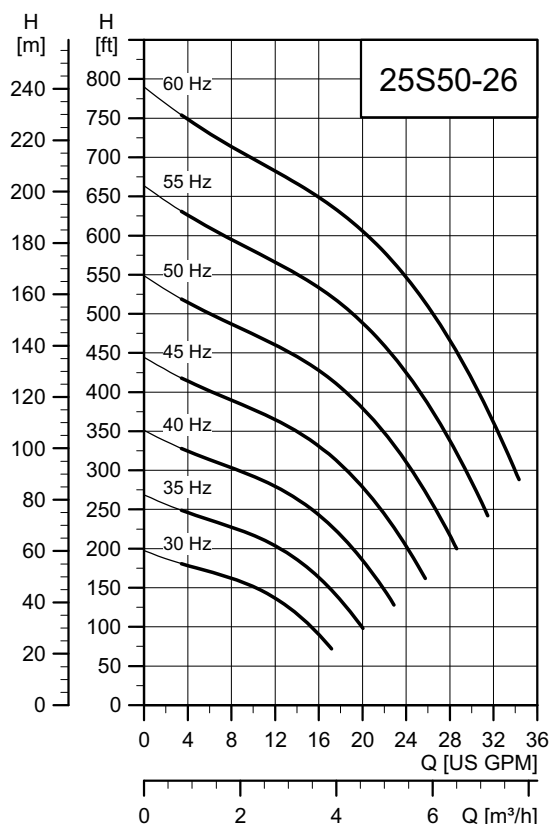
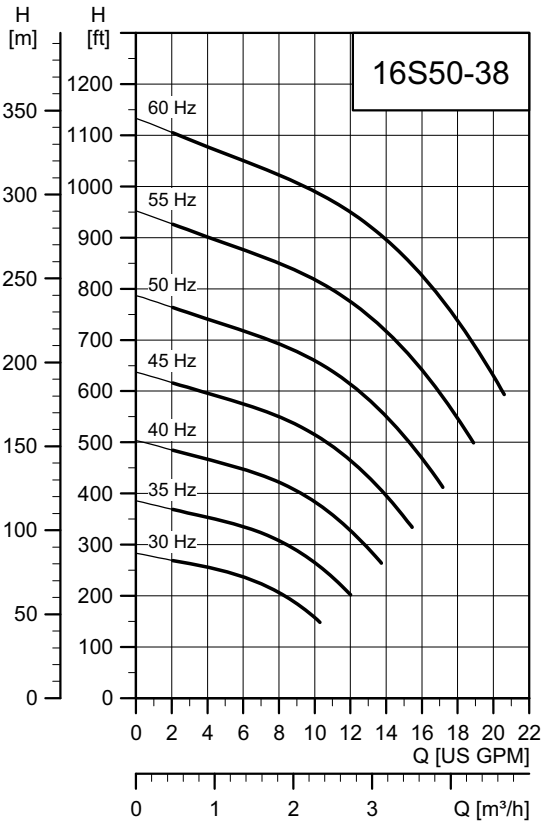
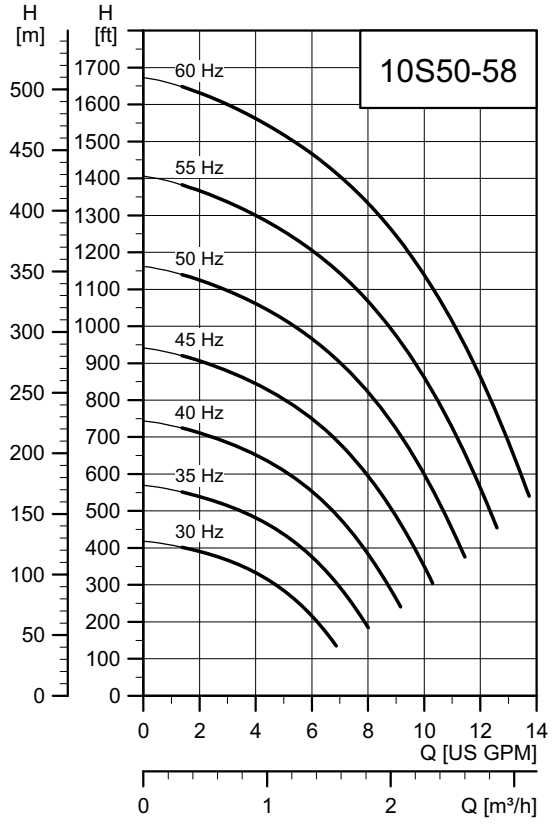
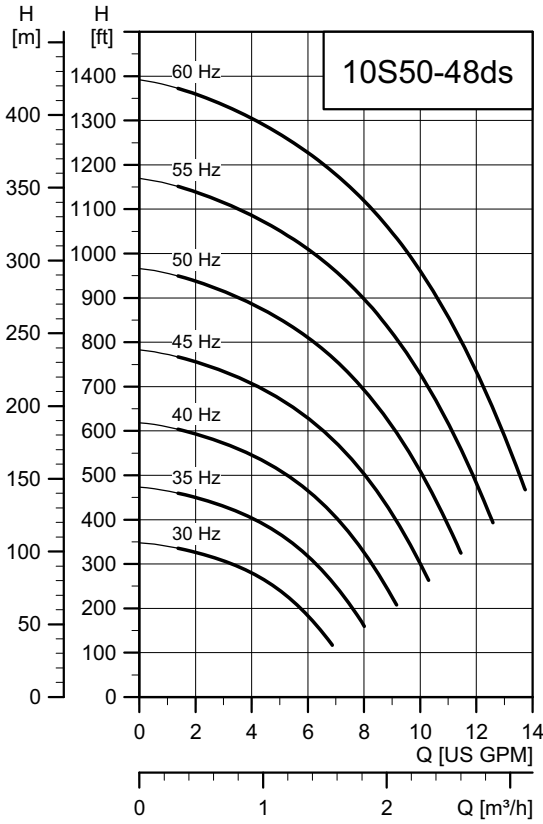

CU331SP, 5 Hp, continued

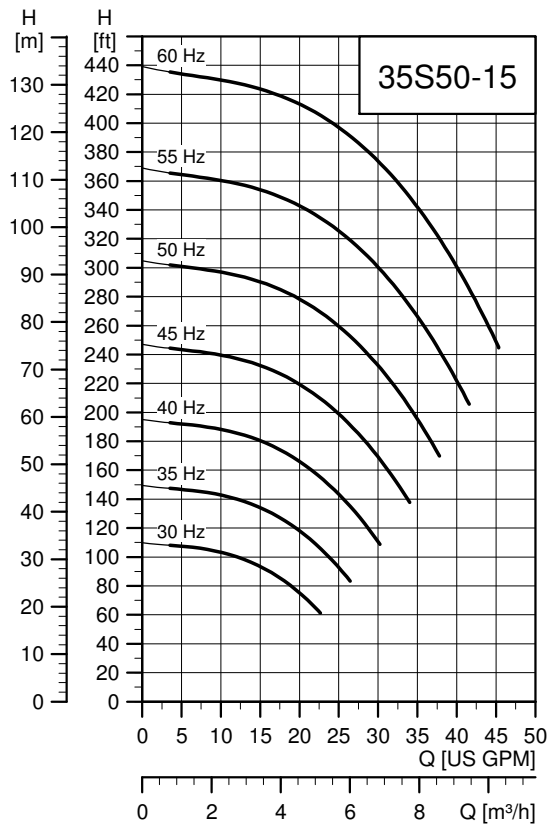

TM06 9749 3217

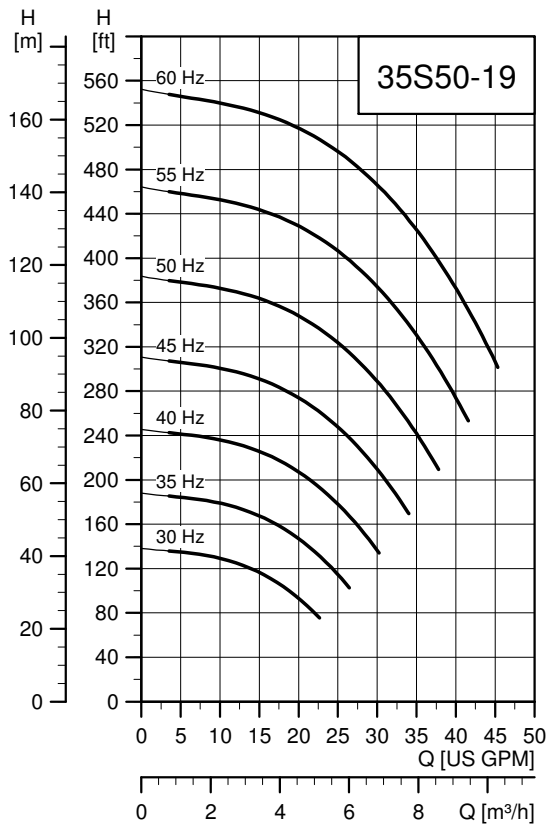

TM06 9750 3217

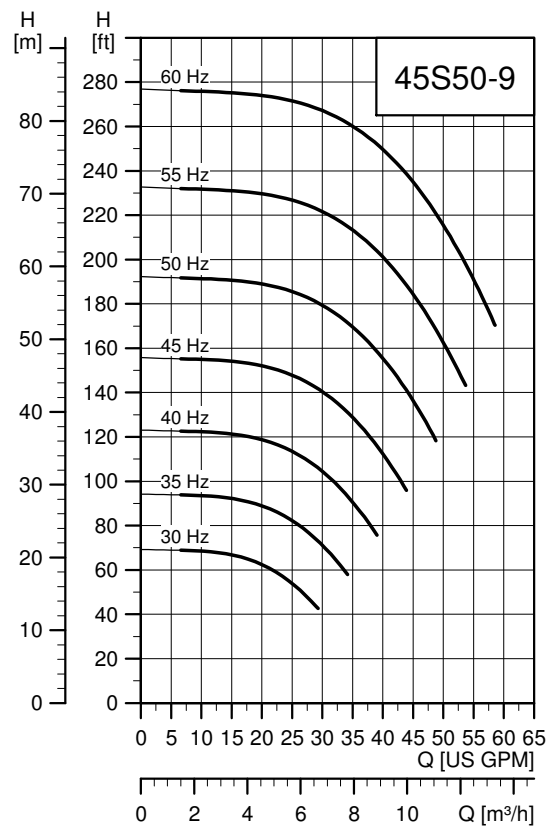

TM06 9753 3217

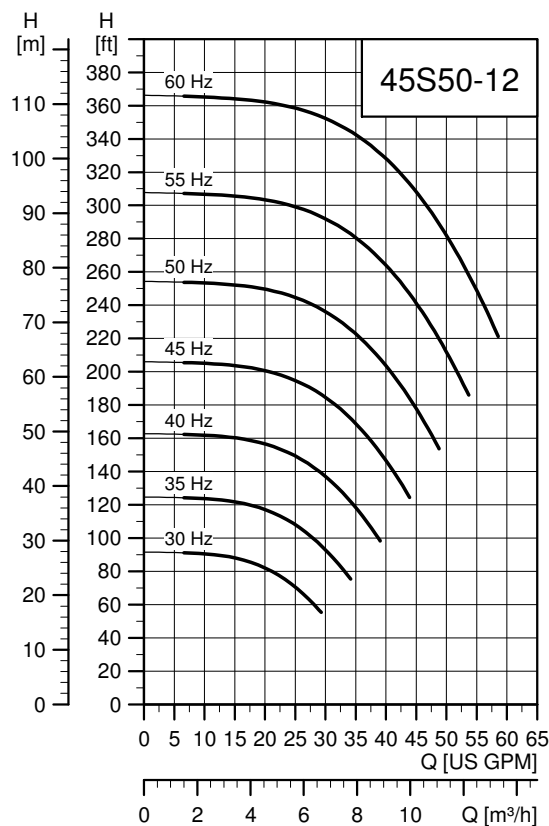

TM06 9754 3217

CU331SP, 5 Hp, continued

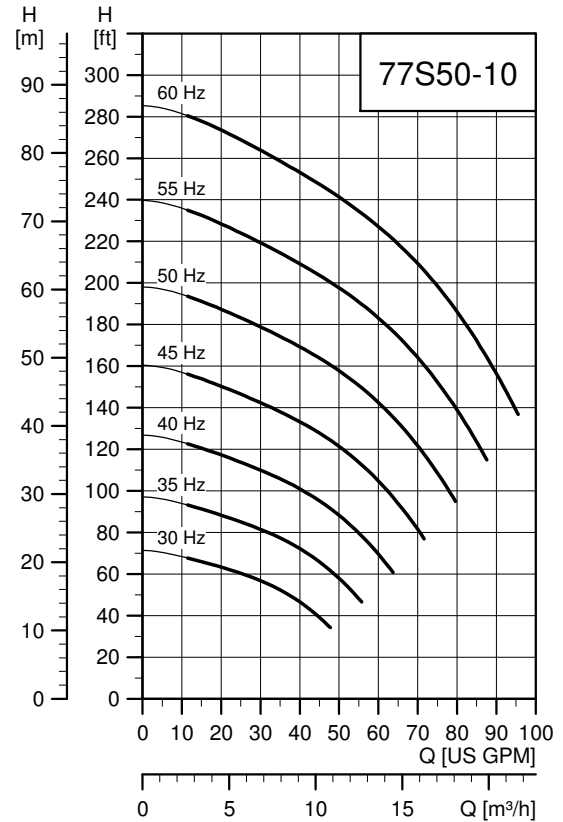
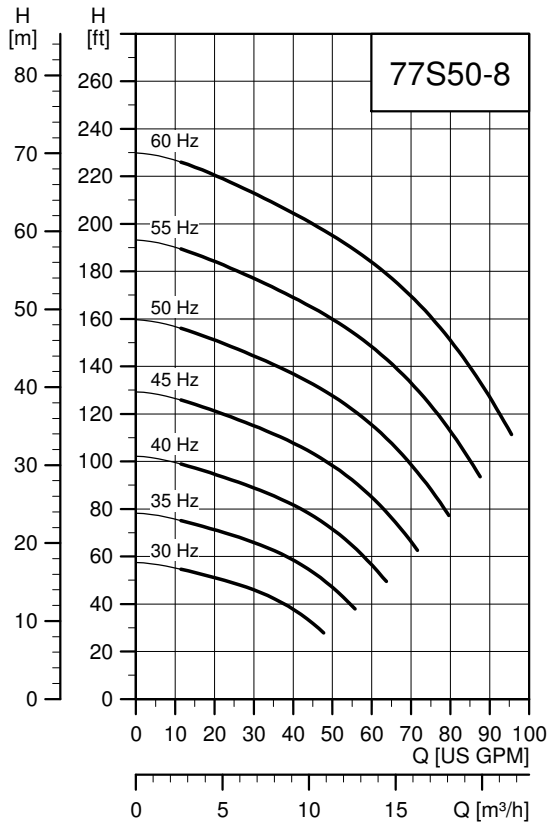
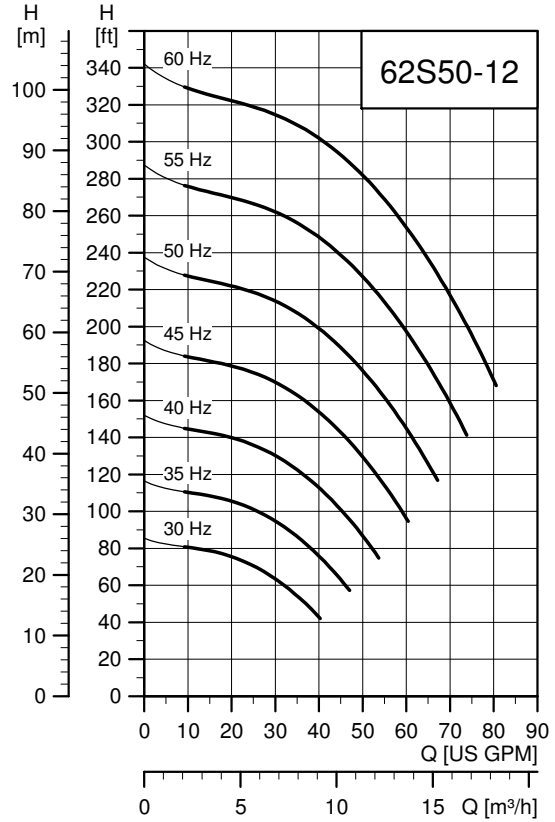
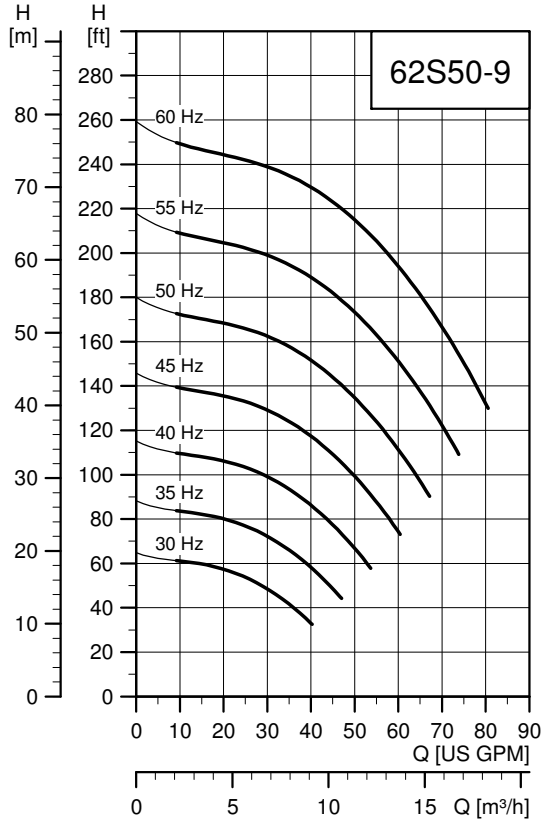

CUE variable frequency drive



Fig. 48 The CUE range

Grundfos CUE is a series of external variable frequency drive designed for speed control of a wide range of Grundfos pumps.

CUE offers quick and easy setup and commissioning compared to a standard variable frequency drive because of the startup guide. Simply key in application-specific variables such as motor data, pump family, control function (for example constant pressure), sensor type and setpoint, and CUE will automatically set all necessary parameters.

CUE enables gentle pumping and thereby protects the water reservoir and the rest of the distribution system, as water hammer can be avoided by adjusting ramp times up and down.

When a CUE is installed, the motor requires no further overload protection. Pt100/1000 together with the MCB 114 provides overheat protection of the motor windings, if needed.

Note: If the motor has a built-in Tempcon sensor, this sensor will be disconnected when it is exposed to the variable frequency drive. An internal fuse in the motor blows and it cannot be replaced. The motor will work without the sensor, but it is not possible to restore the functionality of the Tempcon sensor.

CUE is available in two enclosure classes:

- Nema 1 (IP20/21)
- Nema 12 (IP54/55).

RFI filters

To meet the EMC requirements, CUE comes with the following types of built-in radio frequency interference filter (RFI).

Functions

CUE has a wide range of pump-specific functions, such as:

- constant pressure
- constant level
- constant flow rate
- constant temperature
- constant curve.

Features

- Startup guide
CUE incorporates an innovative startup guide for the general setting of CUE including the setting of the correct direction of rotation. The startup guide is started the first time CUE is connected to the power supply.
- Check of direction of rotation.
- Duty/standby operation.
- Dry-running protection.
- Low-flow stop function.

GrSS 316404 3407

Accessories

Grundfos offers various accessories for CUE.

MCB 114 sensor input module

MCB 114 offers additional analog inputs for CUE:

- 1 analog input, 0/4-20 mA
- 2 inputs for Pt100/Pt1000 temperature sensors.

Output filters

Output filters are used primarily to protect the motor against overvoltage and increased operating temperature. However, output filters can also be used to reduce acoustic noise from the motor.

Grundfos offers sine-wave filters as an CUE accessory.

Sensors

The following sensors can be used in connection with CUE. All sensors are with 4-20 mA output signal.

- pressure sensors, up to 362 psi (25 bar)
- temperature sensors
- differential-pressure sensors
- differential-temperature sensors
- flowmeters
- potentiometer box for external setpoint setting.

Installation

Use of output filters

The table below shows in which cases an output filter is required and which type to use.

The selection depends on these factors:

- pump type
- motor cable length
- the required reduction of acoustic noise from the motor.

Pump type	Typical shaft power, P ₂	Sine-wave filter
SP with 380 V motor and up	All sizes	0-984 ft (0-300 m)

The lengths stated apply to the motor cable.

Cables used in CUE installations

Note: When CUE is installed in connection with SP pumps, we distinguish between two types of installation:

- installation in EMC-insensitive sites. See fig. 49.
- installation in EMC-sensitive sites. See fig. 50.

The two types of installation are different when it comes to the use of screened cable.

Note: Drop cables are always unshielded.

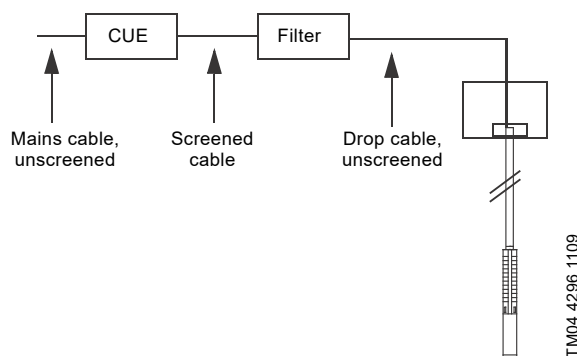

TM04 4296 1109

Fig. 49 Example of installation in EMC-insensitive sites

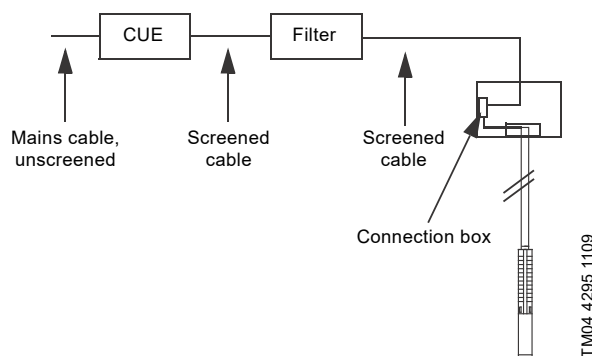

TM04 4295 1109

Fig. 50 Example of installation in EMC-sensitive sites

Screened cables are required in those parts of the installation where the surroundings must be protected against EMC.

CUE is the right choice of variable frequency drive in SP installations as it meets all basic issues.

CUE has a pre-installed startup guide which takes the installer through all the necessary settings.

For more information about the CUE variable frequency drive, see the CUE Data booklet, part number 9886424 or visit Grundfos Product Center at www.grundfos.us.

MP 204

MP 204 is an electronic motor protector, designed for the protection of an asynchronous motor or a pump.

The motor protector consists of:

- a cabinet incorporating transformers and electronics
- a control panel with operating buttons and display for reading of data.

MP 204 operates with two sets of limits:

- a set of warning limits and
- a set of trip limits.

If one or more of the warning limits are exceeded, the motor continues to run, but the warnings will appear in the MP 204 display.

Some values only have a warning limit.

The warning can also be read out by means of Grundfos GO.

If one of the trip limits is exceeded, the trip relay will stop the motor. At the same time, the signal relay is operating to indicate that the limit has been exceeded.

Applications

MP 204 can be used as a stand-alone motor protector.

MP 204 can be monitored via a Grundfos GENIbus.

The power supply to MP 204 is in parallel with the supply to the motor. Motor currents up to 120 A are passed directly through MP 204. MP 204 protects the motor primarily by measuring the motor current by means of a true RMS measurement. MP 204 disconnects the contactor if, for example, the current exceeds the preset value.

Secondarily, the motor is protected via temperature measuring by a Tempcon sensor, a Pt100/Pt1000 sensor and a PTC sensor/thermal switch.

MP 204 is designed for single- and three-phase motors. In single-phase motors, the starting and run capacitors are also measured. $\cos \phi$ is measured in both single- and three-phase systems.

Benefits

MP 204 offers these benefits:

- Suitable for both single- and three-phase motors
- Dry-running protection
- Overload protection
- Very high accuracy
- Made for submersible pumps.

Many monitoring options

MP 204 monitors the following parameters:

- Insulation resistance before startup
- Temperature (Tempcon, Pt sensor and PTC/thermal switch)
- Overload and underload
- Overvoltage and undervoltage
- Phase sequence
- Phase failure
- Power factor
- Power consumption
- Harmonic distortion
- Operating hours and number of starts.



Fig. 51 MP 204

Five sizes of single-turn transformers, 120-999 A.

Note: Monitoring of motor temperature with Tempcon sensor is not possible when single-turn transformers are used.

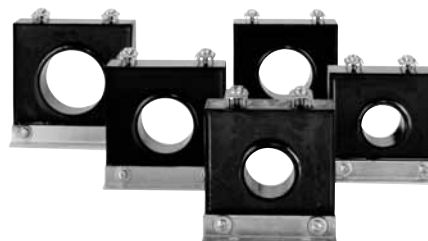

Fig. 52 Single-turn transformers

TM03 1471 2205

TM03 2033 3505

Product numbers

Product	Product number
MP 204	96079927
Single-turn transformers	
Current transformer ratio: 200:5, $I_{max.} = 120$ A	96095274
Current transformer ratio: 300:5, $I_{max.} = 300$ A	96095275
Current transformer ratio: 500:5, $I_{max.} = 500$ A	96095276
Current transformer ratio: 750:5, $I_{max.} = 750$ A	96095277
Current transformer ratio: 1000:5, $I_{max.} = 1000$ A	96095278

Functions

- Phase-sequence monitoring
- Indication of current or temperature (user selection)
- Indication of temperature in °F or °C (user selection)
- 4-digit, 7-segment display
- Setting and status reading with Grundfos GO.
- Setting and status reading via GENIbus.

Tripping conditions

- Overload
- Underload (dry running)
- Temperature (Tempcon sensor, PTC/thermal switch and Pt sensor)
- Phase failure
- Phase sequence
- Overvoltage
- Undervoltage
- Power factor ($\cos \varphi$)
- Current unbalance.

Warnings

- Overload
 - Underload
 - Temperature (Tempcon and Pt sensor)
 - Overvoltage
 - Undervoltage
 - Power factor ($\cos \varphi$)
- Note:** In connection with single- and three-phase connection.
- Run capacitor (single-phase operation)
 - Starting capacitor (single-phase operation)
 - Loss of communication in network
 - Harmonic distortion.

Learning function

- Phase sequence (three-phase operation)
- Run capacitor (single-phase operation)
- Starting capacitor (single-phase operation)
- Identification and measurement of Pt100/Pt1000 sensor circuit.

External current transformers

When fitted with external current transformers, the MP 204 unit can handle currents from 120 to 999 A. Grundfos can supply approved current transformers from stock (200/5A, 300/5A, 500/5A, 750/5A, 1000/5A).

Grundfos GO

Grundfos GO allows for wireless infrared remote control of your MP 204 unit.

With Grundfos GO, you get access to a full range of options such as factory setting adjustment, service and fault finding.

Ready for bus communication

MP 204 allows for monitoring and communication via GENIbus, a Grundfos-designed bus for exchange of pump data, alarms, status information, and setpoints. This enables users to connect MP 204 to, for instance, SCADA systems.

Technical data - MP 204

Enclosure class	IP20
Ambient temperature	-4 °F to +140 °F (-20 °C to +60 °C)
Relative humidity	99 %
Voltage range	100-480 VAC
Current range	3-999 A
Frequency	50 to 60 Hz
IEC trip class	1-45
Special Grundfos trip class	0.1 to 30 s
Voltage variation	- 25 %/+ 15 % of nominal voltage
Approvals	EN 60947, EN 60335, UL/CSA 508
Marking	CE, cUL, C-tick
Consumption	Maximum 5 W
Plastic type	Black PC / ABS

	Measuring range	Accuracy	Resolution
Current without external current transformers	3-120 A	± 1 %	0.1 A
Current with external current transformers	120-999 A	± 1 %	1 A
Phase-to-phase voltage	80-610 VAC	± 1 %	1 V
Frequency	47-63 Hz	± 1 %	0.5 Hz
Power	0-1 MW	± 2 %	1 W
Power factor	0 - 0.99	± 2 %	0.01
Energy consumption	0-4 x 10 ⁹ kWh	± 5 %	1 kWh

Control functions

This table describes the protection provided by MP 204.

Control parameters	Function	Problem	Advantages
Temperature	<p>MS The motor temperature is measured by means of the built-in Tempcon temperature transmitter and a signal is sent to MP 204 via the phase leads. In MP 204 the measured temperature is compared with the factory-set value of 167 °F (75 °C).</p> <p>MMS The motor temperature is measured by means of Pt100/Pt1000. The signal is sent to MP 204 where the measured temperature is compared with the factory-set value. Temperature protection requires a submersible motor with a Pt100/Pt1000. The motor temperature must be monitored during variable frequency drive operation.</p>	Overload, frequent starts/stops, operation against blocked outlet pipe, insufficient flow velocity past the motor.	Longer motor life, safe operating conditions, service indication.
Overvoltage/undervoltage	If the set trip value is exceeded, the motor will stop.	The installation is close to a transformer. The mains do not absorb load variations.	Important installation parameter, possibility of improving operating conditions.
Overload	The motor power input is measured on each of the three phases. The registered power input is an average of these three values. If the factory-set value is exceeded, the motor will stop.	Incorrect sizing of pump/motor, voltage supply failure, defective cable, blocking, wear or corrosion.	Longer pump life, safe operating conditions, service indication.
Underload (dry running)	The motor power input is measured on each of the three phases. The registered power input is an average of these three values. If the average value is lower than the factory-set value, the motor will stop.	Pump exposed to dry running or underload, for example caused by wear.	Traditional dry-running protection is no longer necessary, no extra cables.
Current unbalance	The power input of the motor is measured on each of the three phases.	Mains load is uneven, incipient motor defect, phase voltages diverging.	Motor protection against overload, service indication.
Phase sequence	MP 204 and motor are installed so that the phase sequence corresponds to correct direction of rotation. MP 204 monitors changes in the phase sequence.	Two phases are wrongly connected.	Ensures correct pump performance.
Phase failure	MP 204 checks the phases connected, phase failure will cause an alarm.	Phase failure.	Indication of phase failure, and alarm.

Grundfos GO remote app and Grundfos GO CAPS

Grundfos GO is the mobile tool box for professional users on the go. The Grundfos GO app can be used to establish wireless connection to Grundfos products. Grundfos GO gives you intuitive handheld pump control, and full access to all the Grundfos Online tools on the go. Grundfos GO consists of two Apps: GO Remote and GO CAPS. It is available from Apple App Store and Google Play.

The Grundfos GO app must be used in conjunction with one of the following mobile interface devices:

Product	Description	Product number
MI 202	Dongle for iPhone 4/4s, iPad, or iPod touch (30 pin connector compatible)	98046376
MI 204	Dongle for iPhone, iPad, or iPod touch with Lightning connector	98424092
MI 301	Universal Bluetooth dongle for Android, iPhone or other iOS device	98046408
MI 204	MI204 Kit with MI204 dongle, Apple iPod, sleeve and cover	98612711

The mobile interfaces are modules with built-in IR and radio communication.

The Grundfos product must support either IR communication or radio communication.

Grundfos GO Remote

Grundfos GO Remote works with all our E-pumps and communicates both using both radio and infrared technology. It provides easy-to-follow tips and guidance as well as live pump data feeds.

To communicate with the pumps, special hardware (Mobile Interfaces) from Grundfos is required. The Grundfos GO Remote app can be downloaded for free for both Apple iOS and Android devices.

While connected to a Grundfos product, the following features are available:

- Product dashboard which gives the user a quick overview of the connected product
- Status data which monitor status data from the Grundfos product
- Alarms and warnings where you can see detailed alarm information with timestamps
- Configuration and commissioning
- Create installation report in pdf format
- Read and write profiles, and copy configuration from one product to another
- Available in 28 languages.

Grundfos GO CAPS

GO CAPS works online and supports all the basic CAPS functionalities. It is available for Apple iOS devices only, and is free to download. Features:

- Search product by: Number, Name or QR code
- Size a product (Heating, Air-conditioning, Pressure boosting & Wastewater)
- Catalog
- Replace product
- Compare products
- Product view
- Projects
- Favorites
- Supports 11 languages

MI 202 and MI 204

MI 202 and MI 204 are add-on modules for Apple devices. For Apple iPod touch 4 and iPhone 4 and 4S, use MI 202. For Apple products with Lightning connector, use MI 204.

Note: "Made for iPod, iPhone" means that an electronic accessory has been designed to connect specifically to iPod or iPhone and has been certified by the developer to meet Apple performance standards. Apple is not responsible for the operation of this device or its compliance with safety and regulatory standards. Please note that the use of this accessory with iPod may affect wireless performance.



Fig. 53 MI 202 and MI 204

MI 301

MI 301 is a module that connects to an Android or iOS-based smart device via Bluetooth. MI 301 has a rechargeable Li-ion battery and must be charged separately.



Fig. 54 MI 301

Supported devices

The smart devices listed below have been tested and are supported by Grundfos GO.

Make	Model	MI 202	MI 204	MI 301
Apple	iPod touch 4G	•		•
	iPod touch 5G		•	•
	iPhone 4, 4S	•		•
	iPhone with Lightning connector		•	•
	iPad, iPad Mini		•	•
Asus	Nexus 7			•
	Transformer TF101, TF300			•
Google	Galaxy Nexus, Nexus 4, Nexus 10			•
HTC	Desire S, One S, Sensation			•
Motorola	Xoom2, Moto X (XT1053)			•
Samsung	Galaxy S II, Galaxy S III			•
	Galaxy tab 2 7.0			•
Sony	Xperia Arc, Arc S, Xperia Tipo, Xperia V			•

Note: Similar Android and iOS-based devices may work as well, but have not been tested by Grundfos.

For further details, features and screens, see Grundfos GO instructions part number 98133717 that are included with GO Remote product.

Connecting pieces

The tables below show the range of connecting pieces for connection of thread-to-flange and thread-to-thread.

Thread-to- thread

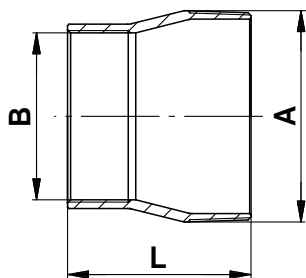

TM01 2397 1698 - GRA2555

Fig. 55 Dimensional sketch and photo of connecting piece thread-to-thread

Type	Connecting piece	Dimensions			Product number	
		Thread-to-thread		L [in (mm)]	304 stainless steel	316 stainless steel
		A	B			
385S	NPT 5→ NPT 4	NPT 5	NPT 4	4.76 (121)	190064	190586
475S	NPT 5→ NPT 6	NPT 5	NPT 6	5.91 (150)	190070	190592
625S 800S 1100S	NPT 6→ NPT 5	NPT 6	NPT 5	5.91 (150)	200135	200645

Zinc anodes

Application

Cathodic protection by means of zinc can be used for corrosion protection of SP pumps in chloride-containing liquids such as brackish water and seawater.

Sacrificial anodes are placed on the outside of the pump and motor as protection against corrosion.

The number of anodes required depends on the pump and motor in question.

Please contact Grundfos for further details.

Liquid temperatures

- Seawater:
Up to 95 °F (35 °C).
- Brackish water (minimum 1500 ppm (g/m³) chloride):
Up to 95 °F (35 °C).

Anode life

The zinc anodes have a life of one to four years, depending on operating conditions (temperature, flow rate and chloride content).

Product numbers of zinc anodes

Zinc anodes for pumps										
Product number	Used for pump type									
	SP 5S to 77S	85S	150S	230S	300S	385S	475S	625S	800S	1100S
99326959	•	-	-	-	-	-	-	-	-	-
97645875	-	•	•	•	•	-	-	-	-	-
97645914	-	-	-	-	-	•	•	-	-	-
97646116	-	-	-	-	-	-	-	•	•	-
97646118	-	-	-	-	-	-	-	-	-	•

Zinc anodes for motors				
4" motors	6" motors	8" motors	10" motors	12" motors
96856060	97645910	97646116	97646118	97646138

SA-SPM 6 control boxes

Application

SA-SPM 6 control boxes are used as starting units for single-phase, 3-wire motors ranging from 0.5 Hp to 5 Hp (.37 kW to 3.7 kW).

SA-SPM 6 from 1.5 Hp to 5 Hp (1.1 kW to 3.7 kW) is available in two versions, Standard (STD) and Deluxe (DLX).

The standard version incorporates a motor-protective circuit breaker and thus protects the motor against overload.

The deluxe version is identical to the standard version with the addition of a motor contactor for connection and disconnection of the power supply.

Technical data

Enclosure class: IP42.
 Ambient temperature: -4 °F to +140 °F (-20 °C to +60 °C).
 Relative humidity: Maximum 95 %, normal non-aggressive atmosphere.



TM03 8150 0607

Fig. 56 SA-SPM 6 control box

SA-SPM 6 control box part numbers

Control box for 4-inch, 3-wire, single phase motors						
Type	Hp	Volts	Approximate ship wt (lb)	Product number (Order in multiples of 1)	Product number (Order in multiples of 10)	Reference product number only**
STD	1/2*	115	2	-	98821580	98315240
STD	1/2*	230	2	-	98821631	98315251
STD	3/4*	230	2	-	98821632	98315252
STD	1*	230	2	-	98821633	98315253
STD	1-1/2	230	2	98315254	-	-
DLX	1-1/2	230	3	98315255	-	-
STD	2	230	6	98315256	-	-
DLX	2	230	6	98315257	-	-
STD	3	230	6	98315258	-	-
DLX	3	230	7	98315259	-	-
STD	5	230	7	98315260	-	-
DLX	5	230	8	98315261	-	-

* The 1/2 hp, 3/4 hp and 1 hp control boxes are now sold by Grundfos in multiple quantities (10-pack) only.

** Old control box material numbers that Grundfos sold in single units.

DLX (Deluxe Control Box.): Includes magnetic starter in addition to Standard Control Box (STD).

Pt100/Pt1000

The Pt100/Pt1000 sensor offers these features:

- Continuous monitoring of the motor temperature
- Protection against too high motor temperature.

Protecting the motor against too high motor temperature is the simplest and cheapest way of avoiding that motor lifetime is reduced. Pt100/Pt1000 ensures that the operating conditions are not exceeded and indicates when it is time for service of the motor.

Monitoring and protection by means of Pt100/Pt1000 require the following parts:







- Pt100/Pt1000 sensor
- Relay, type PR 5714
- Cable.

The PR 5714 relay is fitted with a Pt100/Pt1000 module. For both relays the following temperature limits are preset on delivery:

- 140 °F (60 °C) warning limit
- 167 °F (75 °C) stop limit.

Technical data

	Relay type
	PR 5714
Enclosure class	IP65 (mounted in a control panel)
Ambient temperature	-4 °F to +140 °F (-20 °C to +60 °C)
Relative humidity	95 % (condensating)
Voltage variation	<ul style="list-style-type: none"> • 1 x 24-230 VAC ± 10 %, 50-60 Hz. • 24-250 VDC ± 20 %.
Approvals	UL, DNV
Mark	CE

PR 5714 relay	Voltage	Product number
	24-230 VAC, 50/60 Hz / 24-250 VDC	96621274
PR 5714 relay	Voltage	Product number
	24-230 VAC, 50/60 Hz / 24-250 VDC	96913234
GrA3186 0407		
Pt100 sensor, including cable for standard-, N- and R-versions	Cable length [ft (m)]	
	65.6 (20)	For product number, see Grundfos Price Book or call Grundfos.
	131.2 (40)	
	196.9 (60)	
	262.5 (80)	
	100 (328.1)	
GrA3190 0407		
Staybolt kits for Pt100 in MS 6000	Description	
	Staybolt kit for Pt100/Pt1000. Material: AISI 316 (EN 1.4401).	For product number, see Grundfos Price Book or call Grundfos.
	Staybolt kit for Pt100. Material: AISI 904L (EN 1.4539).	
GrA3191 0407		
Insertion probe for MMS 10000	Description	
	Insertion probe for Pt100/Pt1000 in MMS 10000. Material: 316 (EN 1.4401) (N-version).	For product number, see Grundfos Price Book or call Grundfos.
	Insertion probe for Pt100/Pt1000 in MMS 10000. Material: AISI 904L (EN 1.4539) (R-version).	
TM04 3560 4508		
Pt1000 sensor, including cable	Cable length [ft (m)]	
	65.6 (20)	For product number, see Grundfos Price Book or call Grundfos.
	131.2 (40)	
	196.9 (60)	
	262.5 (80)	
	100 (328.1)	
TM04 3563 4508		
Staybolt kits for Pt1000 in MS 402 and MS 4000	Description	
	Staybolt kit for Pt1000. Material: AISI 316 (EN 1.4401).	For product number, see Grundfos Price Book or call Grundfos.
	Staybolt kit for Pt1000. Material: AISI 904 (EN 1.4539).	
TM05 3694 1612		

10. Energy consumption

Energy consumption of submersible pumps

The percentage distribution of service life costs of a submersible pump for water supply is:

- 5 % initial costs (pump)
- 85 % operating energy costs
- 10 % maintenance costs.

It is obvious that the highest savings can be achieved within energy consumption!

The annual energy consumption, E, of a submersible pump can be calculated as follows:

$$E = c \times h \times P_1 \text{ (USD)}$$

c = specific energy price (USD/kWh)

h = operating hours/year (hours)

P₁ = power input of the submersible pump (Hp).

Example: Calculation of the annual energy consumption of the submersible pump, type 625S-3. 625S-3 with MMS 8000, 60 Hp, 3 x 460 V, 60 Hz.

Duty point:

Flow rate: Q = 528 gpm

Total head: H = 335 ft

Specific energy price: c = USD 0.15/kWh (consisting of day and night rate)

Operating hours/year: h = 3200.

$$P_1 = \frac{Q \times H \times \rho}{367 \times \eta_{\text{pump}} \times \eta_{\text{motor}}} \text{ in kW}$$

Q = gpm

H = ft

Density ρ = lb/ft³ (assumed 1)

367 = conversion factor

η_{motor} = (example 84.5 %, in equation 0.845)

η_{pump} = (not to be confused with the stage efficiency curve).

By showing the P₂/Q curve we make it easier for you to calculate the energy consumption.

$$P_1 = \frac{P_2}{\eta_{\text{motor}}}$$

P₂ = 35 Hp (power requirement of 625S-3 pump at 88 gpm, from curve P₂/Q).

Calculation of motor efficiency at duty point

As standard the SP 625S-3 is equipped with a 60 Hp (45 kW for P₁) MS 6000C motor.

At duty point (Q = 528 gpm) the pump requires 59 Hp (44 kW for P₁), thus:

a motor load of 87 % (44 kw / 45 kw) and a power reserve of 2 %.

From the table on page 94 the motor efficiency can be read as:

84.6 % at a load of 75 %. (η_{75 %})

85.6 % at a load of 100 %. (η_{100 %})

The interpolated value in this example is

$$\eta_{\text{motor}} = 85.1 \%, \eta_{\text{motor}} = 0.851.$$

$$P_1 = \frac{44}{0.851} = 51.7 \text{ kW}$$

$$E = 0.15 \text{ USD/kWh} \times 3200 \text{ h} \times 51.7 \text{ kW}$$

The annual energy costs amount to USD 24816.

The pay-off time, A, (months) is calculated as follows:

$$A = \frac{\text{Purchase price of energy - efficiency pump}}{\text{Energy savings / year}} \times 12$$

Cable sizing

In order to obtain an economical duty of the pump the voltage drop must be low.

Today large water works already size cables for a maximum voltage drop of 1 %.

The hydraulic resistance in the outlet pipe must be as low as possible.

11. Cables

Cable sizing charts

115 V and 230 V, 1 ph 60 Hz

Maximum submersible power cable length (maximum cable length in feet - starter to motor)																	
Motor rating [Hp]	AWG copper wire size [ft (m)]													MCM copper wire size			
	14	12	10	8	6	4	3	2	1	0	00	000	0000	250	300	350	
115 V 1 ph 60 Hz	0.33	130 (40)	210 (64)	340 (104)	540 (165)	840 (256)	1300 (396)	1610 (491)	1960 (597)	2390 (728)	2910 (887)	3540 (1079)	4210 (1283)	5060 (1542)	5680 (1731)	6390 (1948)	7110 (2167)
	0.5	100 (30)	160 (49)	250 (76)	390 (119)	620 (189)	960 (293)	1190 (363)	1460 (445)	1780 (543)	2160 (658)	2630 (802)	3140 (957)	3770 (1149)	4240 (1292)	4770 (1454)	5320 (1622)
230 V 1 ph 60 Hz	0.33	550 (168)	880 (268)	1390 (424)	2190 (668)	3400 (1036)	5250 (1600)	6520 (1987)	7960 (2426)	9690 (2954)	11770 (3587)	14320 (4365)	17050 (5197)	20460 (6236)	22980 (7004)	25850 (7879)	28750 (8763)
	0.5	400 (122)	650 (198)	1020 (311)	1610 (491)	2510 (765)	3880 (1183)	4810 (1466)	5880 (1792)	7170 (2185)	8720 (2658)	10620 (3237)	12660 (3859)	15210 (4636)	17100 (5212)	19260 (5870)	21440 (6535)
	0.75	300 (91)	480 (146)	760 (232)	1200 (366)	1870 (570)	2890 (881)	3580 (1091)	4370 (1332)	5330 (1625)	6470 (1972)	7870 (2399)	9380 (2859)	11250 (3429)	12640 (3853)	14220 (4334)	15810 (4819)
	1	250 (76)	400 (122)	630 (192)	990 (302)	1540 (469)	2380 (725)	2960 (902)	3610 (1100)	4410 (1344)	5360 (1634)	6520 (1987)	7780 (2371)	9350 (2850)	10510 (3203)	11840 (3609)	13180 (4017)
	1.5	190 (58)	310 (94)	480 (146)	770 (235)	1200 (366)	1870 (570)	2320 (707)	2850 (869)	3500 (1067)	4280 (1305)	5240 (1597)	6300 (1920)	7620 (2323)	8630 (2630)	9810 (2990)	10980 (3347)
	2	150 (46)	250 (76)	390 (119)	620 (189)	970 (296)	1530 (466)	1910 (582)	2360 (719)	2930 (893)	3620 (1103)	4480 (1366)	5470 (1667)	6700 (2042)	770 (235)	8890 (2710)	10080 (3072)
	3	120 (37)	190 (58)	300 (91)	470 (143)	750 (229)	1190 (363)	1490 (454)	1850 (564)	2320 (707)	2890 (881)	3610 (1100)	4470 (1362)	5550 (1692)	6450 (1966)	7580 (2310)	8690 (2649)
	5	-	110* (34*)	180 (55)	280 (85)	450 (137)	710 (216)	890 (271)	1110 (338)	1390 (424)	1740 (530)	2170 (661)	2680 (817)	3330 (1015)	3870 (1180)	4550 (1387)	5210 (1588)
	7.5	-	-	120* (37*)	200 (61)	310 (94)	490 (149)	610 (186)	750 (229)	930 (283)	1140 (347)	1410 (430)	1720 (524)	2100 (640)	2400 (732)	2790 (850)	3120 (951)
	10	-	-	-	160* (49*)	250 (76)	390 (119)	490 (149)	600 (183)	750 (229)	930 (283)	1160 (354)	1430 (436)	1760 (536)	2030 (619)	2370 (723)	2700 (823)
15	-	-	-	-	170* (52*)	270 (82)	340 (104)	430 (131)	530 (162)	660 (201)	820 (250)	1020 (311)	1260 (384)	1460 (445)	1700 (518)	1940 (591)	

NOTE:

* Indicates single conductor only (not jacketed).

No asterisk indicates both jacketed cable and single conductor cables.

1. The table is based on copper wire. If aluminum wire is used, multiply lengths by 0.5.

The maximum permissible length of aluminum is considerably shorter than copper wire of same size.

2. Make sure that the portion of the total cable which is between the service entrance and a motor starter/controller does not exceed 25 % of the total maximum length to ensure reliable starter operation. Single-phase control boxes may be connected at any point of the total cable length.

3. The table is based on a maintaining motor terminal voltage at 95 % of service entrance voltage, running at maximum nameplate amperes. In general, a voltage drop must be maintained at 3 V / 100 ft or less.

4. 1 foot = 0.305 meter (1 meter = 3.28 feet).

200-208 V, 3 Ph 60 Hz

Maximum submersible power cable length (maximum cable length in feet - starter to motor)																	
Motor rating [Hp]	AWG copper wire size [ft (m)]													MCM copper wire size			
	14	12	10	8	6	4	3	2	1	0	00	000	0000	250	300	350	
200-208 V 3 ph 60 Hz	.5	710 (216)	1140 (347)	1800 (549)	2840 (866)	4420 (1347)	-	-	-	-	-	-	-	-	-	-	-
	.75	510 (155)	810 (245)	1280 (390)	2030 (619)	3160 (963)	-	-	-	-	-	-	-	-	-	-	-
	1	430 (131)	690 (210)	1080 (329)	1710 (521)	2670 (814)	4140 (1262)	5140 (1567)	-	-	-	-	-	-	-	-	-
	1.5	310 (94)	500 (152)	790 (241)	1260 (384)	1960 (597)	3050 (930)	3780 (1152)	-	-	-	-	-	-	-	-	-
	2	240 (73)	390 (119)	610 (186)	970 (296)	1520 (463)	2360 (719)	2940 (896)	3610 (1100)	4430 (1350)	5420 (1652)	-	-	-	-	-	-
	3	180 (55)	290 (88)	470 (143)	740 (226)	1160 (354)	1810 (552)	2250 (686)	2760 (841)	3390 (1033)	4130 (1259)	-	-	-	-	-	-
	5	110* (34*)	170 (52)	280 (85)	440 (134)	690 (210)	1080 (329)	1350 (411)	1660 (506)	2040 (622)	2490 (759)	3050 (930)	3670 (1119)	4440 (1353)	5030 (1533)	-	-
	7.5	-	-	200 (61)	310 (94)	490 (149)	770 (235)	960 (293)	1180 (360)	1450 (442)	1770 (539)	2170 (661)	2600 (792)	3150 (960)	3560 (1085)	-	-
	10	-	-	-	230* (70*)	370 (113)	570 (174)	720 (219)	880 (268)	1090 (332)	1330 (405)	1640 (500)	1970 (600)	2390 (728)	2720 (829)	3100 (945)	3480 (1061)
	15	-	-	-	160* (49*)	250* (76*)	390 (119)	490 (149)	600 (183)	740 (226)	910 (277)	1110 (338)	1340 (408)	1630 (497)	1850 (564)	2100 (640)	2350 (716)
	20	-	-	-	-	190* (58*)	300* (91*)	380 (116)	460 (140)	570 (174)	700 (213)	860 (262)	1050 (320)	1270 (387)	1440 (439)	1650 (503)	1850 (564)
	25	-	-	-	-	-	240* (73*)	300* (91*)	370* (113*)	460 (140)	570 (174)	700 (213)	840 (256)	1030 (314)	1170 (357)	1330 (405)	1500 (457)
	30	-	-	-	-	-	-	250* (76*)	310* (94*)	380* (116*)	470 (143)	580 (177)	700 (213)	850 (259)	970 (296)	1110 (338)	1250 (381)

NOTE:

* Indicates single conductor only (not jacketed).

No asterisk indicates both jacketed cable and single conductor cables.

- The table is based on copper wire. If aluminum wire is used, multiply lengths by 0.5.
The maximum permissible length of aluminum is considerably shorter than copper wire of same size.
- Make sure that the portion of the total cable which is between the service entrance and a motor starter/controller does not exceed 25 % of the total maximum length to ensure reliable starter operation. Single-phase control boxes may be connected at any point of the total cable length.
- The table is based on a maintaining motor terminal voltage at 95 % of service entrance voltage, running at maximum nameplate amperes. In general, a voltage drop must be maintained at 3 V / 100 ft or less.
- 1 foot = 0.305 meter (1 meter = 3.28 feet).

230 V, three-phase, 60 Hz

Maximum submersible power cable length (maximum cable length in feet, starter to motor)																		
Motor rating [Hp]	AWG copper wire size [ft (m)]													MCM copper wire size				
	14	12	10	8	6	4	3	2	1	0	00	000	0000	250	300	350	400	
230 V 3-ph 60 Hz	.5	930 (283)	1490 (454)	2350 (716)	3700 (1128)	5760 (1756)	8910 (2716)	-	-	-	-	-	-	-	-	-	-	-
	.75	670 (204)	1080 (329)	1700 (518)	2580 (786)	4190 (1277)	6490 (1978)	8060 (2457)	9860 (3005)	-	-	-	-	-	-	-	-	-
	1	560 (171)	910 (277)	1430 (436)	2260 (689)	3520 (1073)	5460 (1664)	6780 (2067)	8290 (2527)	-	-	-	-	-	-	-	-	-
	1.5	420 (128)	670 (204)	1060 (323)	1670 (509)	2610 (796)	4050 (1234)	5030 (1533)	6160 (1878)	7530 (2295)	9170 (2795)	-	-	-	-	-	-	-
	2	320 (98)	510 (155)	810 (247)	1280 (390)	2010 (613)	3130 (954)	3890 (1186)	4770 (1454)	5860 (1786)	7170 (2185)	8780 (2676)	-	-	-	-	-	-
	3	240 (73)	390 (119)	620 (189)	990 (302)	1540 (469)	2400 (732)	2980 (908)	3660 (1116)	4480 (1366)	5470 (1667)	6690 (2039)	8020 (2444)	9680 (2950)	-	-	-	-
	5	140* (43*)	230 (70)	370 (113)	590 (180)	920 (280)	1430 (436)	1790 (546)	2190 (668)	2690 (820)	3290 (1003)	4030 (1228)	4850 (1478)	5870 (1789)	6650 (2027)	7560 (2304)	8460 (2579)	9220 (2810)
	7.5	-	160* (49*)	260 (79)	420 (128)	650 (198)	1020 (311)	1270 (387)	1560 (475)	1920 (585)	2340 (713)	2870 (875)	3440 (1049)	4160 (1268)	4710 (1436)	5340 (1628)	5970 (1820)	6500 (1981)
	10	-	-	190* (58*)	310 (94)	490 (149)	760 (232)	950 (290)	1170 (357)	1440 (439)	1760 (536)	2160 (658)	2610 (796)	3160 (963)	3590 (1094)	4100 (1250)	4600 (1402)	5020 (1530)
	15	-	-	-	210* (64*)	330 (101)	520 (158)	650 (198)	800 (244)	980 (299)	1200 (366)	1470 (448)	1780 (543)	2150 (655)	2440 (744)	2780 (847)	3110 (948)	3400 (1036)
	20	-	-	-	-	250* (76*)	400 (122)	500 (152)	610 (186)	760 (232)	930 (283)	1140 (347)	1380 (421)	1680 (512)	1910 (582)	2180 (664)	2450 (747)	2680 (817)
	25	-	-	-	-	-	320* (98*)	400 (122)	500 (152)	610 (186)	750 (229)	920 (280)	1120 (341)	1360 (415)	1540 (469)	1760 (536)	1980 (604)	2160 (658)
30	-	-	-	-	-	260* (79*)	330* (101*)	410* (125*)	510 (155)	620 (189)	760 (232)	930 (283)	1130 (344)	1280 (390)	1470 (448)	1650 (503)	1800 (549)	

Note:

* Indicates single conductor only (not jacketed).

No asterisk indicates both jacketed cable and single-conductor cables.

- The table is based on copper wire. If aluminum wire is used, multiply lengths by 0.5.
The maximum permissible length of aluminum is considerably shorter than copper wire of same size.
- Make sure that the portion of the total cable which is between the service entrance and a motor starter/controller does not exceed 25 % of the total maximum length to ensure reliable starter operation. Single-phase control boxes may be connected at any point of the total cable length.
- The table is based on maintaining motor terminal voltage at 95 % of service entrance voltage, running at maximum nameplate amperes. In general, a voltage drop must be maintained at 3 V / 100 ft or less.
- 1 foot = 0.305 meter (1 meter = 3.28 feet).

460 V, 3 ph 60 Hz

Maximum submersible power cable length (maximum cable length in feet - starter to motor)																	
Motor rating [Hp]	AWG copper wire size [ft (m)]													MCM copper wire size			
	14	12	10	8	6	4	3	2	1	0	00	000	0000	250	300	350	
460 V 3 ph 60 Hz	.5	3770 (1149)	6020 (1835)	9460 (2883)	-	-	-	-	-	-	-	-	-	-	-	-	
	.75	2730 (832)	4350 (1326)	6850 (2088)	-	-	-	-	-	-	-	-	-	-	-	-	
	1	2300 (701)	3670 (1119)	5770 (1759)	9070 (2765)	-	-	-	-	-	-	-	-	-	-	-	
	1.5	1700 (518)	2710 (826)	4270 (1301)	6730 (2051)	-	-	-	-	-	-	-	-	-	-	-	
	2	1300 (396)	2070 (631)	3270 (997)	5150 (1570)	8050 (2454)	-	-	-	-	-	-	-	-	-	-	
	3	1000 (305)	1600 (488)	2520 (768)	3970 (1210)	6200 (1890)	-	-	-	-	-	-	-	-	-	-	
	5	590 (180)	950 (290)	1500 (457)	2360 (719)	3700 (1128)	5750 (1753)	-	-	-	-	-	-	-	-	-	
	7.5	420 (128)	680 (207)	1070 (326)	1690 (515)	2640 (805)	4100 (1250)	5100 (1554)	6260 (1908)	7680 (2341)	-	-	-	-	-	-	
	10	310 (94)	500 (152)	790 (241)	1250 (381)	1960 (597)	3050 (930)	3800 (1158)	4680 (1426)	5750 (1753)	7050 (2149)	-	-	-	-	-	
	15	-	340* (104*)	540 (165)	850 (259)	1340 (408)	2090 (637)	2600 (792)	3200 (975)	3930 (1198)	4810 (1466)	5900 (1798)	7110 (2167)	-	-	-	
	20	-	-	410 (125)	650 (198)	1030 (314)	1610 (491)	2000 (610)	2470 (753)	3040 (927)	3730 (1137)	4580 (1396)	5530 (1686)	-	-	-	
	25	-	-	330* (101*)	530 (162)	830 (253)	1300 (396)	1620 (494)	1990 (607)	2450 (747)	3010 (917)	3700 (1128)	4470 (1362)	5430 (1655)	-	-	
	30	-	-	270* (82*)	430 (131)	680 (207)	1070 (326)	1330 (405)	1640 (500)	2030 (619)	2490 (759)	3060 (933)	3700 (1128)	4500 (1372)	5130 (1564)	5860 (1786)	
	40	-	-	-	320* (98*)	500* (152*)	790 (241)	980 (299)	1210 (369)	1490 (454)	1830 (558)	2250 (686)	2710 (826)	3290 (1003)	3730 (1137)	4250 (1295)	
	50	-	-	-	-	410* (125*)	640 (195)	800 (244)	980 (299)	1210 (369)	1480 (451)	1810 (552)	2190 (668)	2650 (808)	3010 (917)	3420 (1042)	3830 (1167)
	60	-	-	-	-	-	540* (165*)	670* (204*)	830 (253)	1020 (311)	1250 (381)	1540 (469)	1850 (564)	2240 (683)	2540 (774)	2890 (881)	3240 (988)
	75	-	-	-	-	-	440* (134*)	550* (168*)	680* (207*)	840 (256)	1030 (314)	1260 (384)	1520 (463)	1850 (564)	2100 (640)	2400 (732)	2700 (823)
	100	-	-	-	-	-	-	-	500* (152*)	620 (189*)	760* (232*)	940 (287)	1130 (344)	1380 (421)	1560 (475)	1790 (546)	2010 (613)
	125	-	-	-	-	-	-	-	-	-	600* (183*)	740* (226*)	890* (271*)	1000 (305)	1220 (372)	1390 (424)	1560 (475)
	150	-	-	-	-	-	-	-	-	-	-	630* (192*)	760* (232*)	920* (280*)	1050 (320)	1190 (363)	1340 (408)
175	-	-	-	-	-	-	-	-	-	-	-	670* (204*)	810* (247*)	930* (283*)	1060 (323)	1190 (363)	
200	-	-	-	-	-	-	-	-	-	-	-	590* (180*)	710* (216*)	810* (247*)	920* (280*)	1030 (314)	

NOTE:

* Indicates single conductor only (not jacketed).

No asterisk indicates both jacketed cable and single-conductor cables.

1. The table is based on copper wire. If aluminum wire is used, multiply lengths by 0.5.

The maximum permissible length of aluminum is considerably shorter than copper wire of same size.

2. Make sure that the portion of the total cable which is between the service entrance and a motor starter/controller does not exceed 25 % of the total maximum length to ensure reliable starter operation. Single-phase control boxes may be connected at any point of the total cable length.

3. The table is based on a maintaining motor terminal voltage at 95 % of service entrance voltage, running at maximum nameplate amperes. In general, a voltage drop must be maintained at 3 V / 100 ft or less.

4. 1 foot = 0.305 meter (1 meter = 3.28 feet).

575 V, 3 ph 60 Hz

Maximum submersible power cable length (maximum cable length in feet - starter to motor)																	
Motor rating [Hp]	AWG copper wire size [ft (m)]													MCM copper wire size			
	14	12	10	8	6	4	3	2	1	0	00	000	0000	250	300	350	
575 V 3 ph 60 Hz	5	5900 (1798)	9410 (2868)	-	-	-	-	-	-	-	-	-	-	-	-	-	
	.75	4270 (1301)	6810 (2076)	-	-	-	-	-	-	-	-	-	-	-	-	-	
	1	3630 (1106)	5800 (1768)	9120 (2780)	-	-	-	-	-	-	-	-	-	-	-	-	
	1.5	2620 (799)	4180 (1274)	6580 (2006)	-	-	-	-	-	-	-	-	-	-	-	-	
	2	2030 (619)	3250 (991)	5110 (1558)	8060 (2457)	-	-	-	-	-	-	-	-	-	-	-	
	3	1580 (482)	2530 (771)	3980 (1213)	6270 (1911)	-	-	-	-	-	-	-	-	-	-	-	
	5	920 (280)	1480 (451)	2330 (710)	3680 (1122)	5750 (1753)	-	-	-	-	-	-	-	-	-	-	
	7.5	660 (201)	1060 (323)	1680 (512)	2650 (808)	4150 (1265)	-	-	-	-	-	-	-	-	-	-	
	10	490 (149)	780 (238)	1240 (378)	1950 (594)	3060 (933)	4770 (1454)	5940 (1811)	-	-	-	-	-	-	-	-	
	15	330* (101*)	530 (162)	850 (259)	1340 (408)	2090 (637)	3260 (994)	4060 (1237)	-	-	-	-	-	-	-	-	
	20	-	410* (125*)	650 (198)	1030 (314)	1610 (491)	2520 (768)	3140 (957)	3860 (1177)	4760 (1451)	5830 (1777)	-	-	-	-	-	
	25	-	-	520 (158)	830 (253)	1300 (396)	2030 (619)	2530 (771)	3110 (948)	3840 (1170)	4710 (1436)	-	-	-	-	-	
	30	-	-	430* (131*)	680 (207)	1070 (326)	1670 (509)	2080 (634)	2560 (780)	3160 (963)	3880 (1183)	4770 (1454)	5780 (1762)	7030 (2143)	8000 (2438)	-	-
	40	-	-	-	500* (152*)	790 (241)	1240 (378)	1540 (469)	1900 (579)	2330 (710)	2860 (872)	3510 (1070)	4230 (1289)	5140 (1567)	5830 (1777)	-	-
	50	-	-	-	410* (125*)	640* (195*)	1000 (305)	1250 (381)	1540 (469)	1890 (576)	2310 (704)	2840 (866)	3420 (1042)	4140 (1262)	4700 (1433)	5340 (1628)	5990 (1826)
	60	-	-	-	-	540* (165*)	850 (259)	1060 (323)	1300 (396)	1600 (488)	1960 (597)	2400 (732)	2890 (881)	3500 (1067)	3970 (1210)	4520 (1378)	5070 (1545)
	75	-	-	-	-	-	690* (210*)	860 (262)	1060 (323)	1310 (399)	1600 (488)	1970 (600)	2380 (725)	2890 (881)	3290 (1003)	3750 (1143)	4220 (1286)
	100	-	-	-	-	-	-	640* (195*)	790* (241*)	970 (296)	1190 (363)	1460 (445)	1770 (539)	2150 (655)	2440 (744)	2790 (850)	3140 (957)
	125	-	-	-	-	-	-	-	630* (192*)	770* (235*)	950 (290)	1160 (354)	1400 (427)	1690 (515)	1920 (585)	2180 (664)	2440 (744)
	150	-	-	-	-	-	-	-	-	660* (202*)	800* (244*)	990* (302*)	1190 (363)	1440 (439)	1630 (497)	1860 (567)	2080 (634)
175	-	-	-	-	-	-	-	-	-	700* (214*)	870* (265*)	1050* (320*)	1270 (387)	1450 (442)	1650 (503)	1860 (567)	
200	-	-	-	-	-	-	-	-	-	-	760* (232*)	920* (280*)	1110* (338*)	1260 (384)	1440 (439)	1620 (494)	

NOTE:

* Indicates single conductor only (not jacketed).

No asterisk indicates both jacketed cable and single conductor cables.

1. The table is based on copper wire. If aluminum wire is used, multiply lengths by 0.5.

The maximum permissible length of aluminum is considerably shorter than copper wire of same size.

2. Make sure that the portion of the total cable which is between the service entrance and a motor starter/controller does not exceed 25 % of the total maximum length to ensure reliable starter operation. Single-phase control boxes may be connected at any point of the total cable length.

3. The table is based on a maintaining motor terminal voltage at 95 % of service entrance voltage, running at maximum nameplate amperes. In general, a voltage drop must be maintained at 3 V / 100 ft or less.

4. 1 foot = 0.305 meter (1 meter = 3.28 feet).

12. Friction loss tables

		Friction loss table - SCH 40 steel pipe								
[US gpm]	[US gph]	.5"	.75"	1"	1.25"	1.5"	2"	2.5"	3"	4"
		ID 0.622"	ID 0.824"	ID 1.049"	ID 1.380"	ID 1.610"	ID 2.067"	ID 2.469"	ID 3.068"	ID 4.026"
		Friction loss in feet of head per 100 feet of pipe								
2	120	4.8								
3	180	10.0	2.5							
4	240	17.1	4.2							
5	300	25.8	6.3	1.9						
6	360	36.5	8.9	2.7						
7	420	48.7	11.8	3.6						
8	480	62.7	15.0	4.5						
9	540	78.3	18.8	5.7						
10	600	95.9	23.0	6.9						
12	720		32.6	9.6	2.5	1.2				
14	840		43.5	12.8	3.3	1.5				
16	960		56.3	16.5	4.2	2.0				
20	1,200		86.1	25.1	6.3	2.9				
25	1,500			38.7	9.6	4.5	1.3			
30	1,800			54.6	13.6	6.3	1.8			
35	2,100			73.3	18.2	8.4	2.4			
40	2,400			95.0	23.5	10.8	3.1	1.3		
45	2,700				29.4	13.5	3.9	1.6		
50	3,000				36.0	16.4	4.7	1.9		
60	3,600				51.0	23.2	6.6	2.7		
70	4,200				68.8	31.3	8.9	3.6	1.2	
80	4,800				89.2	40.5	11.4	4.6	1.6	
90	5,400					51.0	14.2	5.8	2.0	
100	6,000					62.2	17.4	7.1	2.4	
120	7,200						24.7	10.1	3.4	
140	8,400						33.2	13.5	4.5	1.2
160	9,600						43.0	17.5	5.8	1.5
200	12,000						66.3	27.0	8.9	2.3
260	15,600							45.0	14.8	3.7
300	18,000							59.6	19.5	4.9

Friction loss table - SCH 40 PVC pipe										
[US gpm]	[US gph]	.5"	.75"	1"	1.25"	1.5"	2"	2.5"	3"	4"
		ID 0.622"	ID 0.824"	ID 1.049"	ID 1.380"	ID 1.610"	ID 2.067"	ID 2.469"	ID 3.068"	ID 4.026"
Friction loss in feet of head per 100 feet of pipe										
2	120	4.1								
3	180	8.7	2.2							
4	240	14.8	3.7							
5	300	22.2	5.7	1.8						
6	360	31.2	8.0	2.5						
7	420	41.5	10.6	3.3						
8	480	53.0	13.5	4.2						
9	540	66.0	16.8	5.2						
10	600	80.5	20.4	6.3	1.7					
12	720		28.6	8.9	2.3	1.1				
14	840		38.0	11.8	3.1	1.4				
16	960		48.6	15.1	4.0	1.9				
20	1,200		60.5	22.8	6.0	2.8				
25	1,500			38.7	9.1	4.3	1.3			
30	1,800				12.7	6.0	1.8			
35	2,100				16.9	8.0	2.4			
40	2,400				21.6	10.2	3.0	1.1		
45	2,700				28.0	12.5	3.8	1.4		
50	3,000					15.4	4.6	1.7		
60	3,600					21.6	6.4	2.3		
70	4,200					28.7	8.5	3.0	1.2	
80	4,800					36.8	10.9	3.8	1.4	
90	5,400					45.7	13.6	4.8	1.8	
100	6,000					56.6	16.5	5.7	2.2	
120	7,200						23.1	8.0	3.0	
140	8,400						30.6	10.5	4.0	1.1
160	9,600						39.3	13.4	5.0	1.4
200	12,000						66.3	20.1	7.6	2.1
260	15,600							32.4	12.2	3.4
300	18,000							42.1	15.8	4.4

Type of fitting and application	Pipe and fitting	Nominal size of fitting and pipe						
		1/2"	3/4"	1"	1.25"	1.5"	2"	2.5"
Friction loss in equivalent length of straight pipe in feet								
Insert coupling	Plastic	3	3	3	3	3	3	3
Threaded adapter (plastic to thread)	Plastic	3	3	3	3	3	3	3
90 ° standard elbow	Steel	2	2	3	4	4	5	6
	Plastic	2	2	3	4	4	5	6
Standard tee (flow through run)	Steel	1	2	2	3	3	4	4
	Plastic	1	2	2	3	3	4	4
Standard tee (flow through side)	Steel	4	5	6	7	8	11	13
	Plastic	4	5	6	7	8	11	13
Gate valve ¹	Steel	1	1	1	1	2	2	2
Swing check valve ¹	Steel	5	7	9	12	13	17	21

Notes:

Based on Schedule 40 steel and plastic fittings.

Friction loss figures are for screwed valves and are based on equivalent lengths of steel pipe.

13. Grundfos Product Center

Grundfos Product Center is an online search and sizing tool to help you make the right choice.

<http://product-selection.grundfos.com>



SIZING enables you to size a pump based on entered data and selection choices.

REPLACEMENT enables you to find a replacement product. Search results will include information on

- the lowest purchase price
- the lowest energy consumption
- the lowest total life cycle cost.

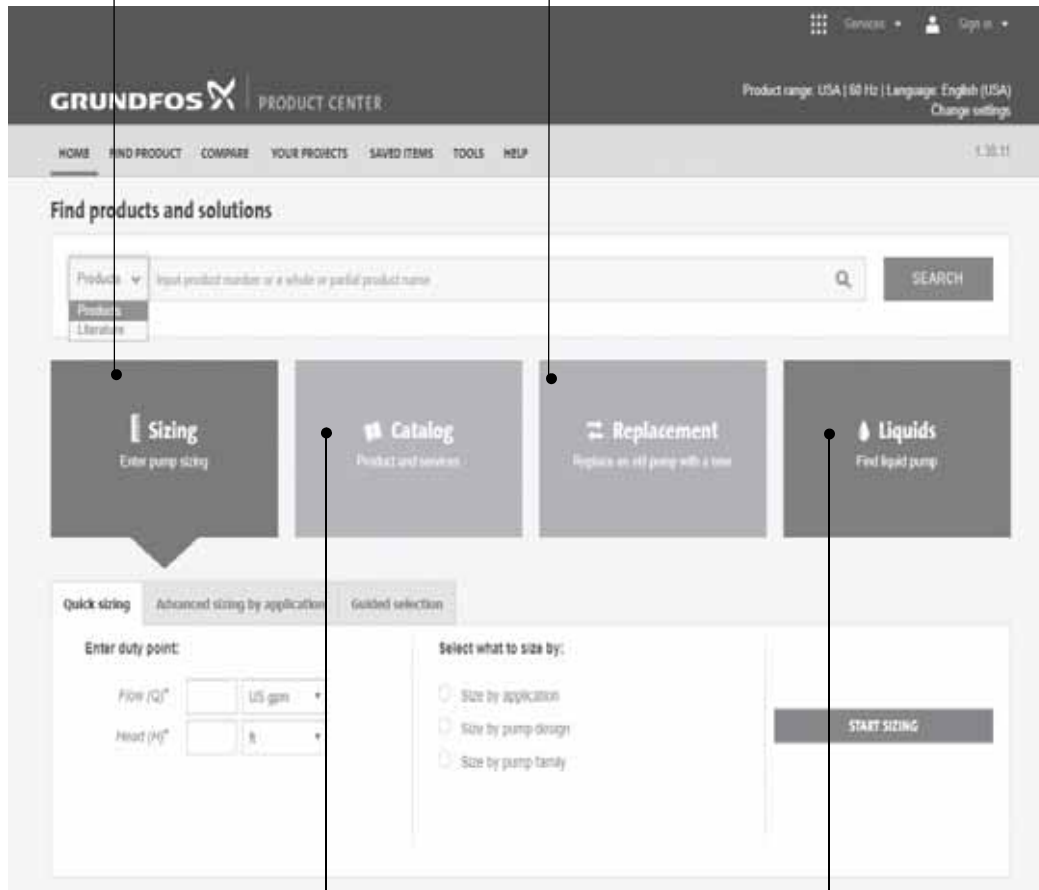

CATALOG gives you access to the Grundfos product catalog.

LIQUIDS enables you to find pumps designed for aggressive, flammable or other special liquids.

All the information you need in one place

Performance curves, technical specifications, pictures, dimensional drawings, motor curves, wiring diagrams, spare parts, service kits, 3D drawings, documents, system parts. The Product Center displays any recent and saved items - including complete projects - right on the main page.

Downloads

On the product pages, you can download installation and Operating Instructions, data booklets, service instructions, etc. in PDF format.

Subject to alterations.

98992402 0120

ECM: 1278912

GRUNDFOS Chicago

3905 Enterprise Court
P.O. Box 6620
Aurora, IL 60598-0620
Phone: +1-630-236-5500
Fax: +1-630-236-5511

GRUNDFOS Kansas City

9300 Loiret Boulevard
Lenexa, Kansas 6619
Phone: +1-913-227-3400
Fax: +1-913-227-3500

GRUNDFOS CBS

902 Koomey Road
Brookshire, TX 77423
Phone: +1-281-994-2700
Fax: +1-800-945-4777

www.grundfos.us

Canada

GRUNDFOS Canada
2941 Brighton Road
Phone: +1-905-829-9533
Fax: +1-905-829-9512

www.grundfos.ca

México

GRUNDFOS México
Boulevard TLC No. 15
Parque Industrial Stiva Aeropuerto
Phone: +011-52-81-8144-4000
Fax: +011-52-81-8144-4010

www.grundfos.mx