

EOM

ENGINEERING OPERATION
& MAINTENANCE MANUAL

PS810 and PS1510 Brahma Bolted Metal Pump

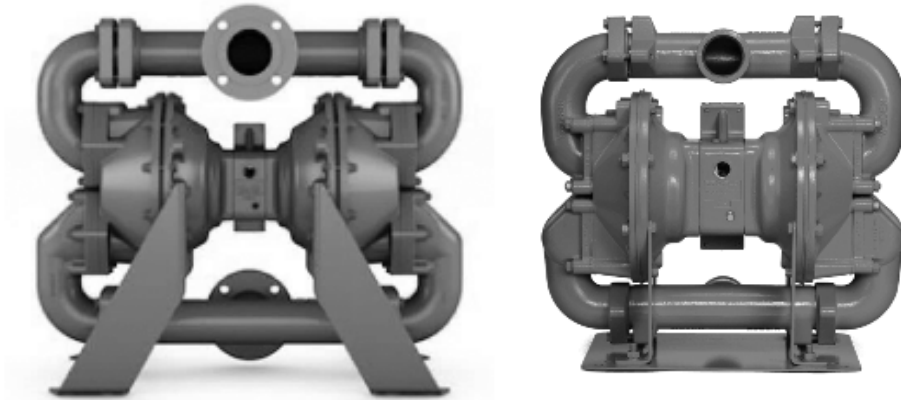

Where Innovation Flows



Copyright

Copyright 2018 PSG[®], a Dover Company. All rights reserved.

PSG reserves the right to modify the information and illustrations in this document without prior notice. The product described in this document is furnished under a license agreement or nondisclosure agreement. No part of this document may be reproduced, stored in a retrieval system, or transmitted in any form or any means electronic or mechanical, including photocopying and recording, without the written permission of PSG, a Dover Company, except as described by the terms of those agreements.

This is a non-contractual document.

Trademarks

PSG and the PSG logo are registered trademarks of PSG. Wilden[®] is a registered trademark of PSG California LLC. Pro-Flo[®] SHIFT and Pro-Flo[®] are registered trademarks of PSG California LLC. Wil-Flex[®] is a trademark of PSG California LLC. Saniflex[™] is a trademark of PSG California LLC.

All trademarks, names, logos and service marks (collectively “trademarks”) in this document are registered and unregistered trademarks of their respective owners. Nothing contained in this document should be construed as granting any license or right to use any trademark without the prior written permission of the trademark owner.

Warranty

Each and every product manufactured by Wilden is built to meet the highest standards of quality. Every pump is functionally tested to ensure integrity of operation. Wilden warrants that pumps, accessories and parts manufactured or supplied by it to be free from defects in material and workmanship for a period of five (5) years from date of installation or six (6) years from date of manufacture, whichever comes first.

For more information, and to register your Wilden pump for warranty, please visit <https://www.psgdover.com/wilden/support/warranty-registration>.

Certifications



CONTENTS

SECTION 1: Precautions – Read First!4

SECTION 2: Wilden Pump Designation System.....5

SECTION 3: How It Works6

SECTION 4: Dimensional Drawings7

SECTION 5: Performance.....9

 PS810 Brahma Rubber-Fitted.....9

 PS1510 Brahma Rubber-Fitted.....9

 Suction Lift Capability11

SECTION 6: Suggested Installation, Operation, Maintenance, and Troubleshooting.....13

SECTION 7: Disassembly/Reassembly16

 Pump Disassembly16

 Air Valve/Center Section Disassembly19

 Single-Point Exhaust.....22

 Reassembly Hints and Tips22

SECTION 8: Exploded View and Parts List.....24

 PS810 Brahma.....24

 PS1510 Brahma.....26

SECTION 9: Elastomer Options.....30

SECTION 1

PRECAUTIONS – READ FIRST!

 **WARNING:** Always wear safety glasses when operating a pump to avoid eye injury. If diaphragm rupture occurs, material being pumped may be forced out of the air exhaust.

 **CAUTION:** Do not apply compressed air to the exhaust port – pump will not function.

 **CAUTION:** Do not over-lubricate air supply– excess lubrication will reduce pump performance. Pump is pre-lubed.

 **TEMPERATURE LIMITS:**

Acetal	-29°C to 82°C	-20°F to 180°F
Buna-N	-12°C to 82°C	10°F to 180°F
Geolast®	-40°C to 82°C	-40°F to 180°F
Neoprene	-18°C to 93°C	0°F to 200°F
Nordel EPDM	-51°C to 138°C	-60°F to 280°F
Nylon	-18°C to 93°C	0°F to 200°F
PFA	-7°C to 107°C	45°F to 225°F
Polypropylene	0°C to 79°C	32°F to 175°F
Polyurethane	-12°C to 66°C	10°F to 150°F
PVDF	-12°C to 107°C	10°F to 225°F
Saniflex	-29°C to 104°C	-20°F to 220°F
SIPD PTFE with EPDM-backed	4°C to 137°C	40°F to 280°F
SIPD PTFE with Neoprene-backed	4°C to 93°C	40°F to 200°F
PTFE*	4°C to 104°C	40°F to 220°F
FKM	-40°C to 177°C	-40°F to 350°F
Wil-Flex	-40°C to 107°C	-40°F to 225°F

*4°C to 149°C (40°F to 300°F) - 13 mm (1/2") and 25 mm (1") models only.

NOTE: Not all materials are available for all models. See "Wilden Pump Designation System" for material options for your pump.

 **CAUTION:** When choosing pump materials, be sure to check the temperature limits for all wetted components. Example: FKM has a maximum limit of 177°C (350°F), but polypropylene has a maximum limit of only 79°C (175°F).

 **CAUTION:** Maximum temperature limits are based on mechanical stress only. Certain chemicals will reduce maximum safe operating temperatures significantly. Consult the Chemical Resistance Guide for chemical compatibility and temperature limits.

 **CAUTION:** All Wilden pumps are capable of passing solids. Use a strainer on the pump intake to ensure that the pump's rated solids capacity is not exceeded.

 **CAUTION:** Do not exceed 8.6 bar (125 psig) air supply pressure.

 **CAUTION:** Do not exceed 82°C (180°F) air inlet temperature for all models.

 **CAUTION:** The process fluid and cleaning fluids must be compatible chemically with all wetted pump components.

 **CAUTION:** Before attempting any maintenance or repair, disconnect the compressed air line to the pump and allow all air pressure to bleed from the pump. Disconnect all intake, discharge, and air lines. Drain the pump by turning it upside down and allowing any fluid to flow into a suitable container. Be aware of any hazardous effects of contact with your process fluid.

 **CAUTION:** Thoroughly flush pumps before installing them into process lines. Clean and/or sanitize FDA- and USDA- approved pumps before using them.

 **CAUTION:** Before attaching the air line to the pump, blow out the air line for 10 to 20 seconds to make sure all pipeline debris is clear. Use an in-line air filter. A 5µ (micron) air filter is recommended.

 **CAUTION:** Pro-Flo pumps cannot be used in submersible applications. Pro-Flo SHIFT is available in both single-point exhaust (submersible) and standard (non-submersible) options. Do not use standard Pro-Flo SHIFT models in submersible applications.

 **CAUTION:** Before installation, tighten all hardware.

 **NOTE:** Materials of construction and elastomer material may influence suction lift parameters. Please refer to "Performance" for specifics.

 **NOTE:** When installing PTFE diaphragms, it is important to tighten outer pistons simultaneously (turning in opposite directions) to ensure tight fit. (See "Maximum Torque Specifications").

 **NOTE:** Some PTFE-fitted pumps come standard from the factory with expanded PTFE gaskets installed in the diaphragm bead of the liquid chamber. PTFE gaskets cannot be re-used.

 **NOTE:** In the event of a power failure, close the shut-off valve if you do not want the pump to restart when the power returns.

 **NOTE:** The Safety Supplement document is a part of the manual. Please refer to the Safety Supplement document for a complete list of safety considerations including considerations for safe operation and maintenance of pumps marked for ATEX environments before starting the pump.

 **WARNING:** This product can expose you to chemicals including Nickel, Chromium, Cadmium, or Cobalt, which are known to the State of California to cause cancer and/or birth defects or other reproductive harm. For more information, go to www.P65Warnings.ca.gov.

SECTION 3

HOW IT WORKS – AIR-OPERATED DOUBLE-DIAPHRAGM PUMP

The Wilden diaphragm pump is an air-operated, positive displacement, self-priming pump. These drawings show flow pattern through the pump upon its initial stroke. It is assumed the pump has no fluid in it prior to its initial stroke.

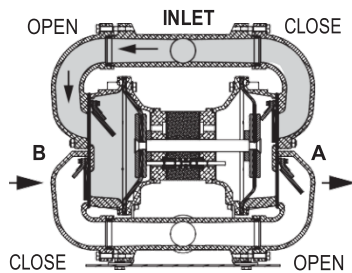

FIGURE 1 The air valve directs pressurized air to the back side of diaphragm A. The compressed air is applied directly to the liquid column separated by elastomeric diaphragms. The diaphragm acts as a separation membrane between the compressed air and liquid; a balanced load removes mechanical stress from the diaphragm. The compressed air moves the diaphragm away from the center of the pump. The opposite diaphragm is pulled in by the shaft connected to the pressurized diaphragm. Diaphragm B is on its suction stroke; air behind the diaphragm has been forced out to atmosphere through the exhaust port of the pump. The movement of diaphragm B toward the center of the pump creates a vacuum within chamber B. Atmospheric pressure forces fluid into the inlet manifold forcing the inlet check valve off its seat. Liquid is free to move past the inlet check valve and fill the liquid chamber (see shaded area).

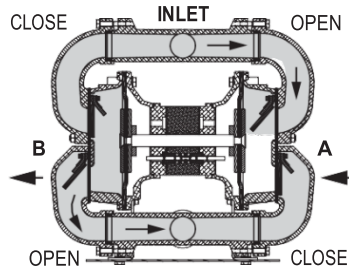

FIGURE 2 When the pressurized diaphragm, diaphragm A, reaches the limit of its discharge stroke, the air valve redirects pressurized air to the back side of diaphragm B. The pressurized air forces diaphragm B away from the center while pulling diaphragm A to the center. Diaphragm B is now on its discharge stroke. Diaphragm B forces the inlet check valve onto its seat due to the hydraulic forces developed in the liquid chamber and manifold of the pump. These same hydraulic forces lift the discharge check valve off its seat, while the opposite discharge check valve is forced onto its seat, forcing fluid to flow through the pump discharge. The movement of diaphragm A toward the center creates a vacuum within liquid chamber A. Atmospheric pressure forces fluid into the inlet manifold of the pump. The inlet check valve is forced off its seat allowing the fluid being pumped to fill the liquid chamber.

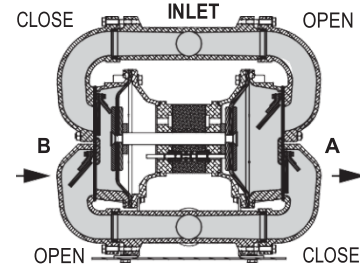
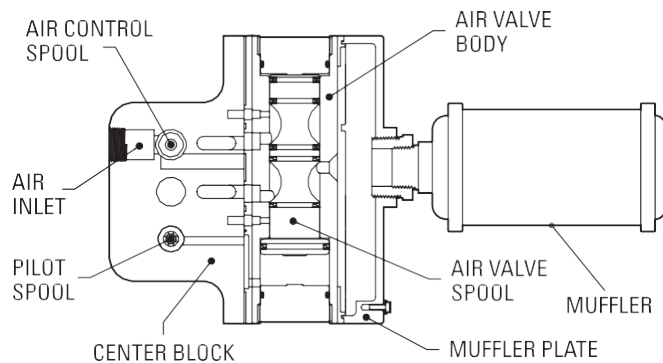

FIGURE 3 At completion of the stroke, the air valve again redirects air to the back side of diaphragm A, which starts diaphragm B on its suction stroke. As the pump reaches its original starting point, each diaphragm has gone through one suction and one discharge stroke. This constitutes one complete pumping cycle. The pump may take several cycles to completely prime depending on the conditions of the application.

NOTE: Unlike other Wilden pumps, the fluid inlet of the Brahma pump is located at the top and the fluid discharge is located at the bottom of the pump.

HOW IT WORKS – AIR DISTRIBUTION SYSTEM



The heart of the patented Pro-Flo® SHIFT Air Distribution System (ADS) is the air valve assembly. The air valve design incorporates an unbalanced spool with the small end of the spool being pressurized continuously while the large end of the spool is alternately pressurized, then exhausted to move the spool. The air valve spool directs pressurized air to one chamber while exhausting the other. The air forces the main shaft/diaphragm assembly to move to one side – discharging liquid on that side and pulling liquid in on the other side. When the shaft reaches the end of the stroke, the inner piston actuates the pilot spool, which controls the air to the large end of the air valve spool. The repositioning of the air valve spool routes the air to the other chamber. The air control spool allows air to flow freely into the air chamber for the majority of each pump stroke, but it significantly restricts the flow of air into the air chamber when activated by the inner piston near the end of each stroke.

SECTION 4

DIMENSIONAL DRAWING

PS810 BRAHMA

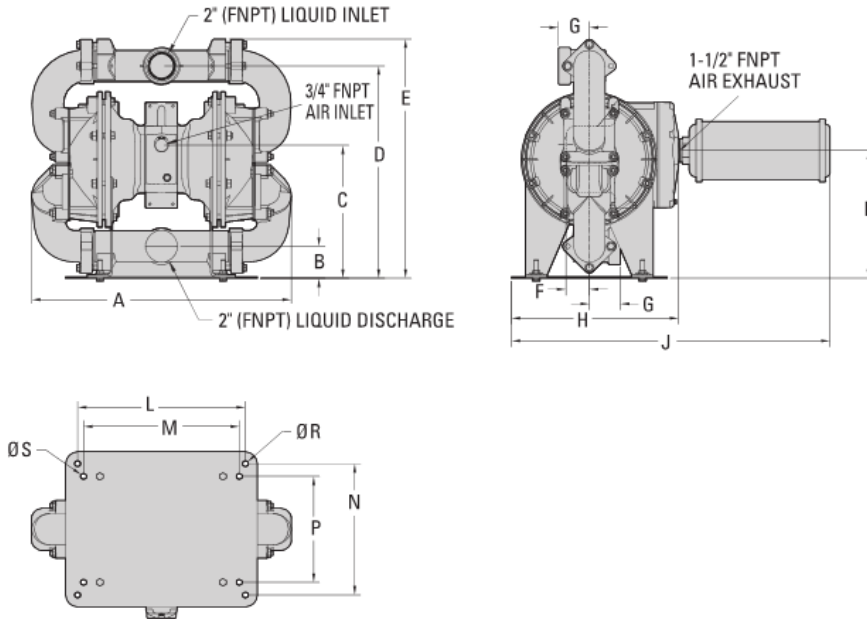

DIMENSIONS

ITEM	METRIC (mm)	STANDARD (inch)
A	550	21.7
B	68	2.7
C	283	11.1
D	451	17.8
E	509	20.0
F	50	2.0
G	66	2.6
H	354	13.9
J	680	26.7
K	272	10.7
L	356	14.0
M	330	13.0
N	279	11.0
P	226	8.9
R	13	0.5
S	13	0.5

LW0281 REV. A

PS1510 BRAHMA

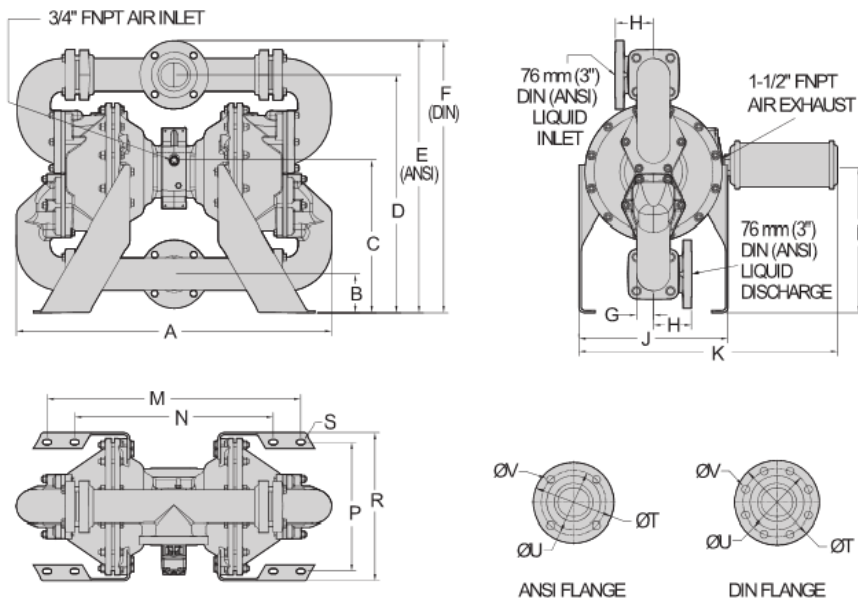

DIMENSIONS

ITEM	METRIC (mm)	STANDARD (inch)
A	874	34.4
B	107	4.2
C	422	16.6
D	658	25.9
E	754	29.7
F	757	29.8
G	46	1.8
H	104	4.1
J	411	16.2
K	716	28.2
L	401	15.8
M	704	27.7
N	551	21.7
P	358	14.1
R	411	16.2
S	8.0	0.3
	DIN (mm)	ANSI (inch)
T	200 DIA.	7.5 DIA.
U	160 DIA.	6.0 DIA.
V	18 DIA.	0.8 DIA.

LW0284 REV. B

SECTION 5

PERFORMANCE

PS810 BRAHMA RUBBER-FITTED

Ship WeightAluminum 37 kg (81 lb)
 Ductile Iron 57 kg (125 lb)
 Air Inlet.....3/4"
 Inlet.....51 mm (2")
 Outlet.....51 mm (2")
 Suction Lift.....7.4 m Dry (24.3')
 9.0 m Wet (29.5')
 Disp. per Stroke¹.....1.8 L (0.475 gal)
 Max. Flow Rate.....640 lpm (169 gpm)
 Max. Size Solids.....51 mm (2")

¹Displacement per stroke was calculated at 4.8 bar (70 psig) air inlet pressure against a 2.1 bar (30 psig) head pressure.

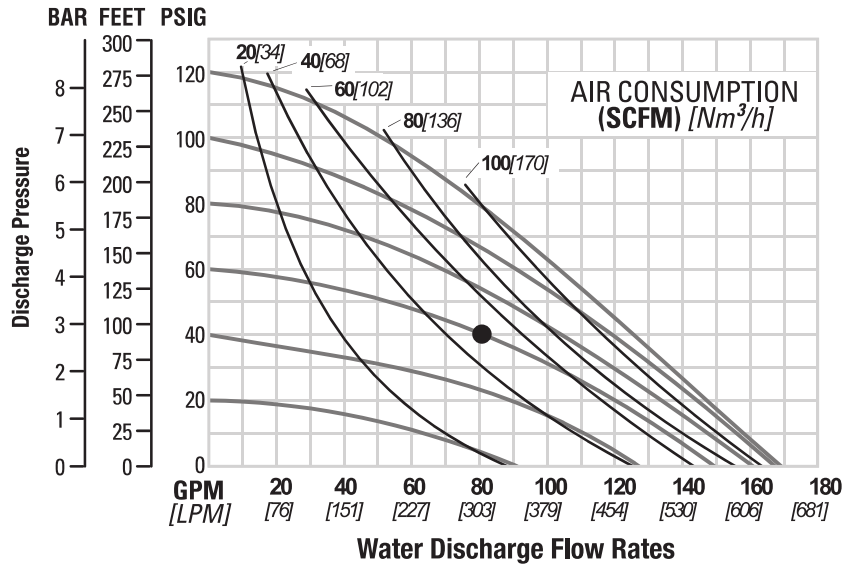

Example: To pump 303 lpm (80 gpm) against a discharge head of 2.8 bar (40 psig) requires 4.2 bar (60 psig) and 82 Nm³/h (48 scfm) air consumption.

Flow rates indicated on chart were determined by pumping water. For optimum life and performance, pumps should be specified so that daily operation parameters will fall in the center of the pump's performance curve.

Caution: Do not exceed 8.6 bar (125 psig) air supply pressure.

PS1510 BRAHMA RUBBER-FITTED

Ship WeightAluminum 81 kg (179 lb)
 Ductile Iron 159 kg (350 lb)
 Air Inlet.....3/4"
 Inlet.....76 mm (3")
 Outlet.....76 mm (3")
 Suction Lift.....7.1 m Dry (23.3')
 9.0 m Wet (29.5')
 Disp. per Stroke¹.....4.7 L (1.24 gal)
 Max. Flow Rate.....882 lpm (233 gpm)
 Max. Size Solids.....76 mm (3")

¹Displacement per stroke was calculated at 4.8 bar (70 psig) air inlet pressure against a 2.1 bar (30 psig) head pressure.

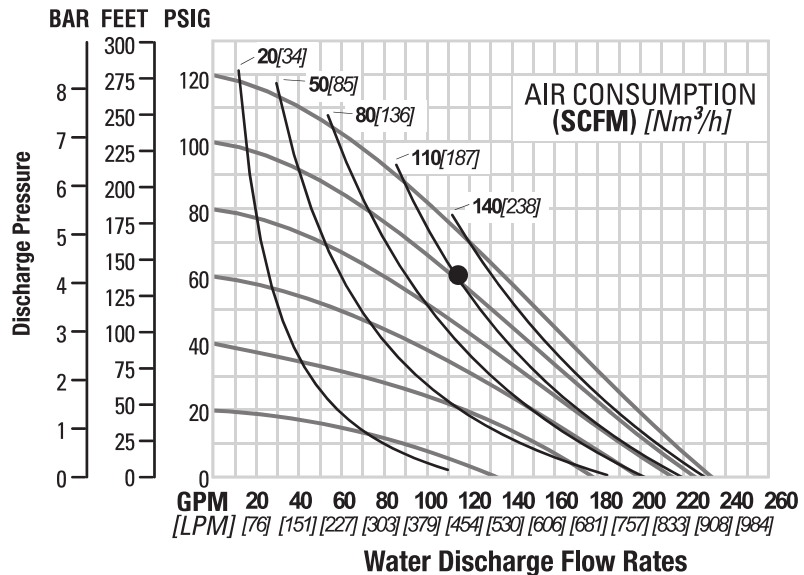

Example: To pump 401 lpm (106 gpm) against a discharge head of 4.2 bar (60 psig) requires 7.0 bar (100 psig) and 187 Nm³/h (110 scfm) air consumption.

Flow rates indicated on chart were determined by pumping water. For optimum life and performance, pumps should be specified so that daily operation parameters will fall in the center of the pump's performance curve.

Caution: Do not exceed 8.6 bar (125 psig) air supply pressure.

SUCTION LIFT CAPABILITY

**PS810 BRAHMA
SUCTION LIFT
CAPABILITY**

Suction-lift curves are calibrated for pumps operating at 305 m (1,000') above sea level. This chart is meant to be a guide only. There are many variables that can affect your pump's operating characteristics. The number of intake and discharge elbows, viscosity of pumping fluid, elevation (atmospheric pressure) and pipe friction loss all affect the amount of suction lift your pump will attain.

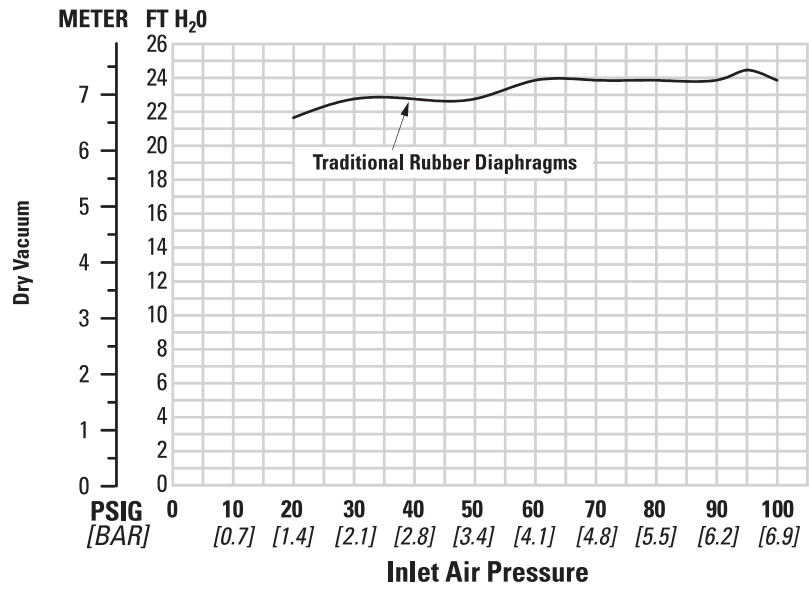

**PS1510 BRAHMA
SUCTION LIFT
CAPABILITY**

Suction-lift curves are calibrated for pumps operating at 305 m (1,000') above sea level. This chart is meant to be a guide only. There are many variables that can affect your pump's operating characteristics. The number of intake and discharge elbows, viscosity of pumping fluid, elevation (atmospheric pressure) and pipe friction loss all affect the amount of suction lift your pump will attain.

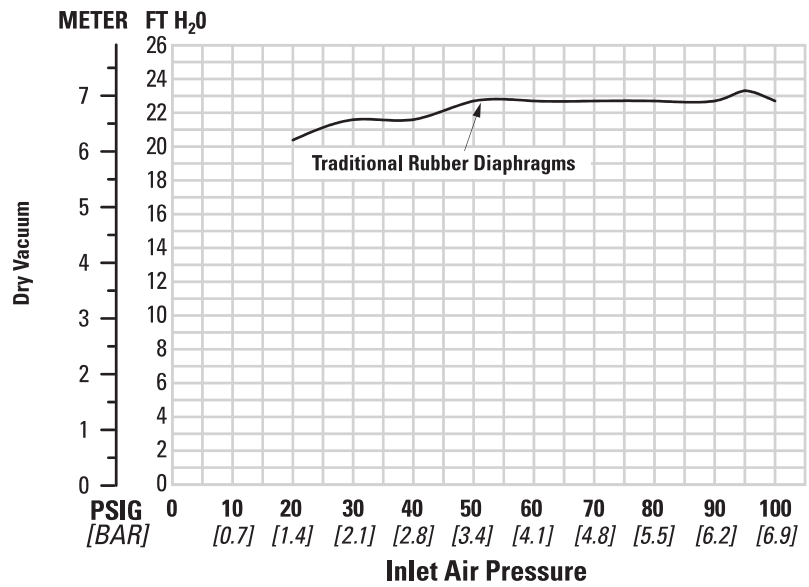

SECTION 6

SUGGESTED INSTALLATION, OPERATION, MAINTENANCE AND TROUBLESHOOTING

Wilden pumps are designed to meet the performance requirements of even the most demanding pumping applications. They have been designed and manufactured to the highest standards and are available in a variety of liquid path materials to meet your chemical resistance needs. Refer to "Performance" for an in-depth analysis of the performance characteristics of your pump. Wilden offers the widest variety of elastomer options in the industry to satisfy temperature, chemical compatibility, abrasion resistance and flex concerns.

The suction pipe size should be at least equal to or larger than the diameter size of the suction inlet on your Wilden pump. The suction hose must be a non-collapsible, reinforced type because these pumps are capable of pulling a high vacuum. Discharge piping should also be equal to or larger than the diameter of the pump discharge, which will help reduce friction losses.

 **CAUTION:** All fittings and connections must be airtight. Otherwise, pump suction capability will be reduced or lost.

Months of careful planning, study and selection efforts can result in unsatisfactory pump performance if installation details are left to chance. You can avoid premature failure and long-term dissatisfaction by exercising reasonable care throughout the installation process.

Location

Noise, safety and other logistical factors usually dictate where equipment will be situated on the production floor. Multiple installations with conflicting requirements can result in congestion of utility areas, leaving few choices for additional pumps. Within the framework of these and other existing conditions, locate every pump in such a way that the following six key factors are balanced against each other to maximum advantage:

- **Access:** First, the location should be accessible. If it's easy to reach the pump, maintenance personnel will be able to perform routine inspections and adjustments more easily. If major repairs become necessary, ease of access can play a key role in speeding the repair process and reducing total downtime.
- **Air Supply:** Every pump location should have an air line large enough to supply the volume of air necessary to achieve the desired pumping rate. For best results, the pumps should use a 5µ (micron) air filter, needle valve and regulator. The use of an air filter before the pump will ensure that the majority of any pipeline contaminants will be eliminated.
- **Solenoid Operation:** When operation is controlled by a solenoid valve in the air line, three-way valves should be used. This valve allows trapped air between the valve and the pump to bleed off, which improves pump performance. You can estimate pumping volume by counting the number of strokes per minute, and then multiplying that figure by the displacement per stroke.
- **Muffler:** Using the standard Wilden muffler, sound levels are reduced below OSHA specifications. You can use other mufflers to reduce sound levels farther, but they usually reduce pump performance.
- **Elevation:** Selecting a site that is well within the pump's dynamic lift capability will assure that loss-of-prime issues will

be eliminated. In addition, pump efficiency can be adversely affected if proper attention is not given to site location.

- **Piping:** Final determination of the pump site should not be made until the piping challenges of each possible location have been evaluated. The impact of current and future installations should be considered ahead of time to make sure that inadvertent restrictions are not created for any remaining sites.

The best choice possible will be a site involving the shortest and straightest hook-up of suction and discharge piping. Unnecessary elbows, bends and fittings should be avoided. Pipe sizes should be selected to keep friction losses within practical limits. All piping should be supported independently of the pump. In addition, the piping should be aligned to avoid placing stress on the pump fittings.

Flexible hose can be installed to aid in absorbing the forces created by the natural reciprocating action of the pump. If the pump is to be bolted down to a solid location, a mounting pad placed between the pump and the foundation will assist in minimizing pump vibration. Flexible connections between the pump and rigid piping will also assist in minimizing pump vibration. If quick-closing valves are installed at any point in the discharge system, or if pulsation within a system becomes a problem, a surge suppressor (SD Equalizer) should be installed to protect the pump, piping and gauges from surges and water hammer.

If the pump is to be used in a self-priming application, make sure that all connections are airtight and that the suction lift is within the model's ability.

 **NOTE:** Materials of construction and elastomer material have an effect on suction lift parameters. Please refer to "Performance" for specifics.

When pumps are installed in applications involving flooded suction or suction head pressures, a gate valve should be installed in the suction line to permit closing of the line for pump service.

Pumps in service with a positive suction head are most efficient when inlet pressure is limited to 0.5–0.7 bar (7–10 psig). Premature diaphragm failure may occur if positive suction is 0.7 bar (10 psig) and higher.

Single-Point Exhaust

Pro-Flo SHIFT pumps can be used for submersible applications when using the Pro-Flo SHIFT's single-point exhaust.

 **CAUTION:** All Wilden pumps are capable of passing solids. Use a strainer on the pump intake to ensure that the pump's rated solids capacity is not exceeded.

 **CAUTION:** Do not exceed 8.6 bar (125 psig) air supply pressure.

SUGGESTED INSTALLATION, OPERATION, MAINTENANCE AND TROUBLESHOOTING

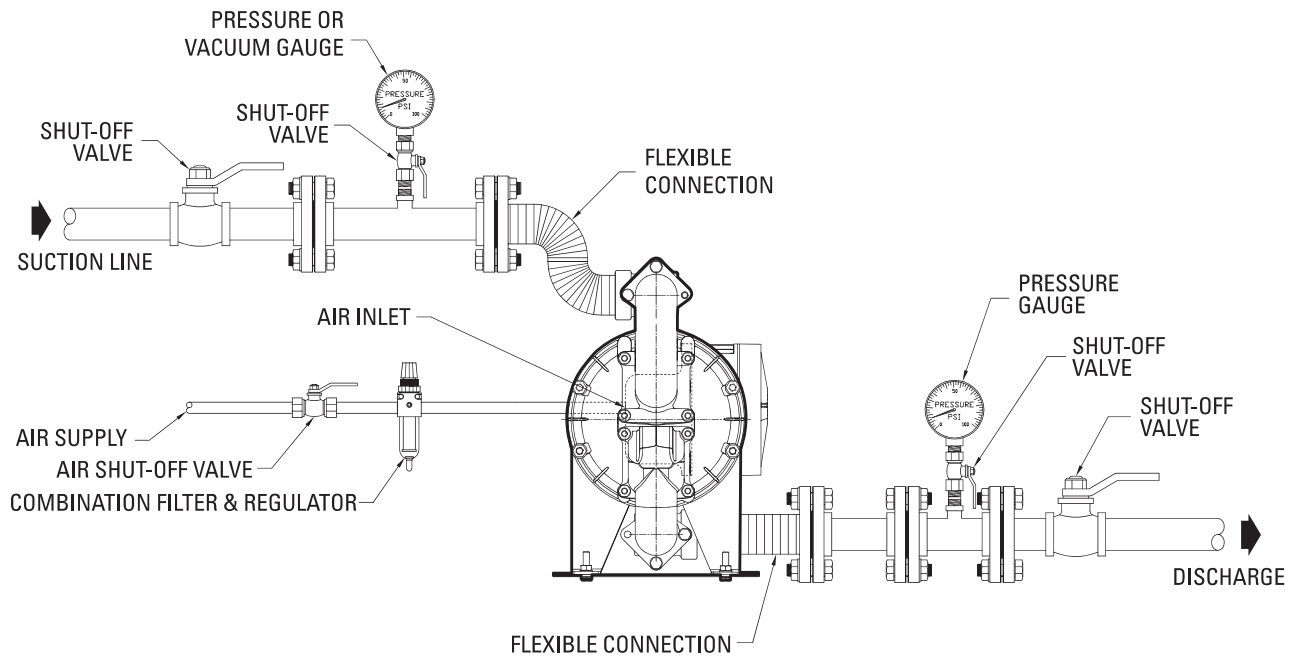

! **NOTE:** In the event of a power failure, close the shut-off valve if you do not want the pump to restart when the power returns.

! **NOTE:** The fluid inlet to the PS Brahma pump is located at the top and the fluid discharge is located at the bottom of the pump.

Air-Operated Pumps: To stop the pump from operating in an emergency, simply close the shut-off valve (user-supplied) installed in the air supply line. A properly functioning valve will stop the air supply to the pump, therefore stopping output. This shut-off valve should be located far enough away from the pumping equipment such that it can be reached safely in an emergency.

Operation

PS Stallion pumps are pre-lubricated, and do not require in-line lubrication. Additional lubrication will not damage the pump, however if the pump is heavily lubricated by an external source, the pump's internal lubrication may be washed away. If the pump is then moved to a non-lubricated location, it may need to be disassembled and re-lubricated as described in the DISASSEMBLY/REASSEMBLY.

Pump discharge rate can be controlled by limiting the volume and/or pressure of the air supply to the pump. An air regulator is used to regulate air pressure. A needle valve is used to regulate volume. Pump discharge rate can also be controlled by throttling the pump discharge by partially closing a valve in the discharge line of the pump. This action increases friction loss which reduces flow rate. (See Section 5.) This is useful when the need exists to control the pump from a remote location. When the pump discharge pressure equals or exceeds the air supply pressure, the pump will stop; no bypass or pressure relief valve is needed, and pump damage will not

occur. The pump has reached a "deadhead" situation and can be restarted by reducing the fluid discharge pressure or increasing the air inlet pressure.

Prior to Maintenance

Before any maintenance is performed, confirm pump is completely de-energized by shutting off the pump and disconnecting the gas supply line to the pump.

Refer to REASSEMBLY HINTS & TIPS and EXPLODED VIEW & PARTS LISTINGS in the EOM manual for maintenance and spare parts information.

Maintenance and Inspections

Since each application is unique, maintenance schedules may be different for every pump. Frequency of use, line pressure, viscosity and abrasiveness of process fluid all affect the parts life of a Wilden pump. Periodic inspections have been found to offer the best means for preventing unscheduled pump downtime. Personnel familiar with the pump's construction and service should be informed of any abnormalities that are detected during operation.

Records

When service is required, a record should be made of all necessary repairs and replacements. Over a period of time, such records can become a valuable tool for predicting and preventing future maintenance problems and unscheduled downtime. In addition, accurate records make it possible to identify pumps that are poorly suited to their applications.

SUGGESTED INSTALLATION, OPERATION, MAINTENANCE AND TROUBLESHOOTING

Troubleshooting

Pump will not run or runs slowly.

1. Remove plug from pilot spool exhaust.
2. Ensure that the air inlet pressure is at least 0.4 bar (5 psig) above startup pressure and that the differential pressure (the difference between air inlet and liquid discharge pressures) is not less than 0.7 bar (10 psig).
3. Check air inlet filter for debris (see "Suggested Installation, Operation, Maintenance and Troubleshooting").
4. Check for extreme air leakage (blow by) that would indicate worn seals/bores in the air valve, pilot spool and main shaft.
5. Disassemble the pump and check for obstructions in the air passageways or objects that would obstruct the movement of internal parts.
6. Check for sticking ball check valves.
 - a. If material being pumped is not compatible with pump elastomers, swelling may occur. Replace ball check valves and seals with proper elastomers.
 - b. Also, as the check valve balls wear out, they become smaller and can become stuck in the seats. In this case, replace balls and seats.
7. Check for any broken inner piston that would cause the air valve spool to be unable to shift.

Pump runs, but little or no product flows.

1. Check for pump cavitation. Slow pump speed down to allow thick material to flow into liquid chambers.
2. Verify that vacuum required to lift liquid is not greater than the vapor pressure of the material being pumped (cavitation).
3. Check for sticking ball check valves.
 - a. If material being pumped is not compatible with pump elastomers, swelling may occur. Replace ball check valves and seals with proper elastomers.
 - b. Also, as the check valve balls wear out, they become smaller and can become stuck in the seats. In this case, replace balls and seats.

Pump air valve freezes.

1. Check for excessive moisture in the compressed air.
 - a. Either install a dryer or a hot air generator for compressed air.
 - b. Alternatively, you may use coalescing filter to remove the water from the compressed air in some applications.

Air bubbles in pump discharge.

1. Check for a ruptured diaphragm.
2. Check tightness of outer pistons (see "Disassembly/Reassembly").
3. Check tightness of fasteners and integrity of O-rings and seals, especially at intake manifold.
4. Ensure pipe connections are airtight.

Product comes out air exhaust.

1. Check for a diaphragm rupture.
2. Check the tightness of the outer pistons to the shaft.

SECTION 7

DISASSEMBLY / REASSEMBLY

PUMP DISASSEMBLY

Tools Required:

- 7/32" Hex-Head Wrench
- 3/8" Hex-Head Wrench
- 7/16" Wrench
- 9/16" Wrench
- 5/8" Wrench



CAUTION: Before attempting any maintenance or repair, disconnect the compressed air line to the pump and allow all air pressure to bleed from the pump. Disconnect all intake, discharge, and air lines. Drain the pump by turning it upside down and allowing any fluid to flow into a suitable container. Be aware of any hazardous effects of contact with your process fluid.



NOTE: Your specific pump model may vary from the configuration shown; however, pump disassembly procedure will be the same.



NOTE: Replace worn parts with genuine Wilden parts for reliable performance.

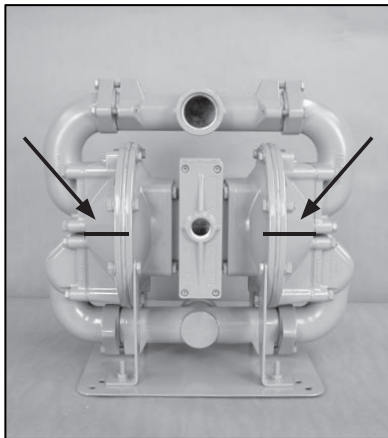

Step 1

Before starting disassembly, mark a line from each liquid chamber to its corresponding air chamber to note alignment. This will assist in proper alignment during reassembly.

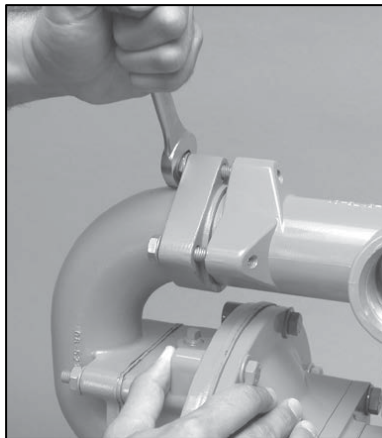

Step 2

Using a 9/16" wrench, remove the fasteners that connect the inlet elbow to the inlet T-section.



Step 3

Using a 9/16" wrench, remove the fastener that connects the elbow to the liquid chamber.

DISASSEMBLY / REASSEMBLY

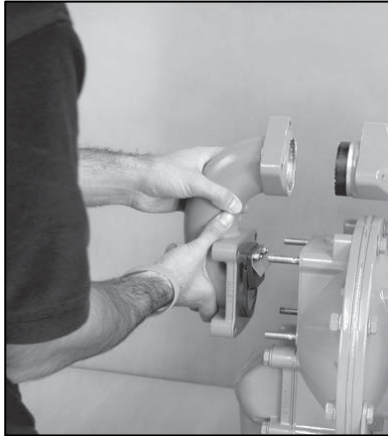

Step 4

Next, remove the inlet elbow from the liquid chamber.

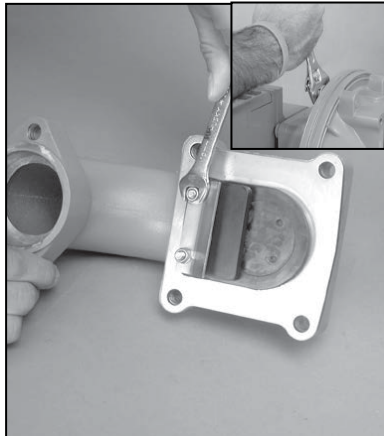

Step 5

Using a 7/16" wrench, remove the flap valve assembly from the inlet elbow. Inspect flap valves for nicks, gouges, chemical attack or abrasive wear.

NOTE: Replace worn parts with genuine Wilden parts for reliable performance.

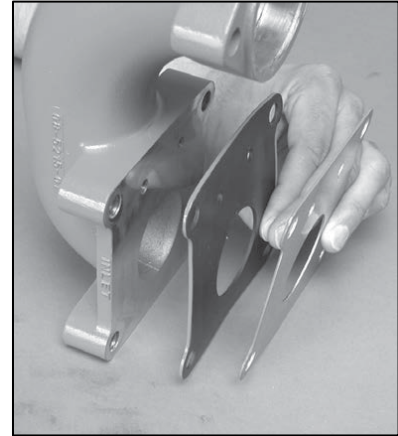

Step 6

Inspect manifold gasket, flap valve seat and seat gasket for nicks, gouges, chemical attack or abrasive wear.

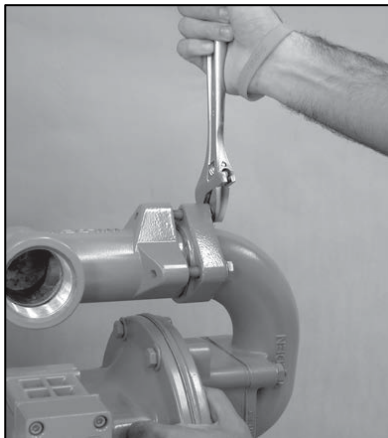

Step 7

Using a 9/16" wrench, remove the fasteners that connect the remaining inlet elbow to the inlet T-section.

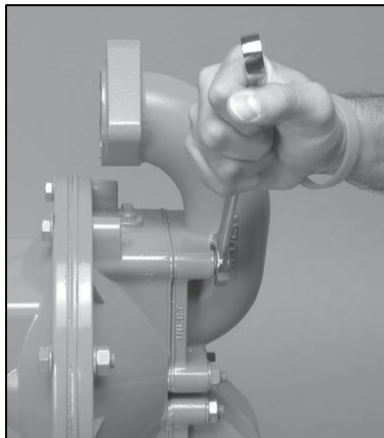

Step 8

Using a 9/16" wrench, remove the fasteners that connect the remaining inlet elbow to the liquid chamber.

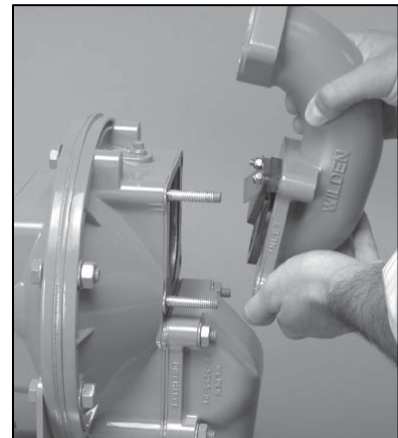

Step 9

Next, remove the remaining inlet elbow from the liquid chamber.

DISASSEMBLY / REASSEMBLY

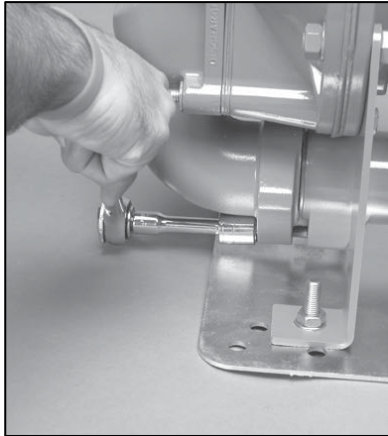

Step 10

Using a 9/16" wrench, remove the fasteners that connect the discharge elbow to the discharge T-section. To simplify this process, a socket extension can be used for easier access to the fastener.

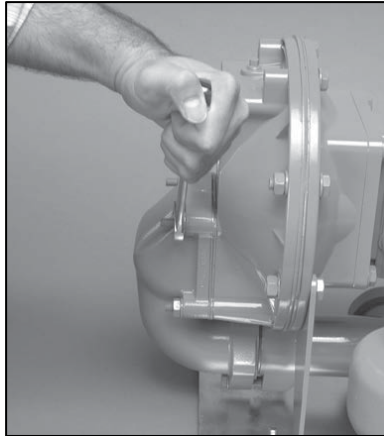

Step 11

Using a 9/16" wrench, remove the fasteners that connect the discharge elbow to the liquid chamber.

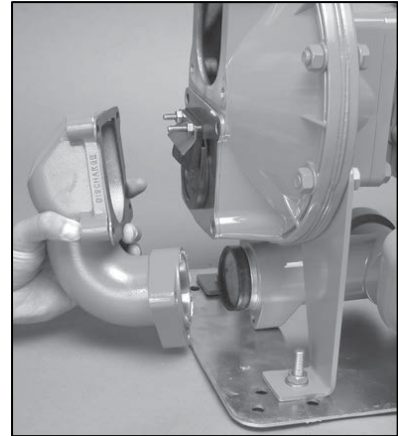

Step 12

Next, remove the discharge elbow from the liquid chamber.



Step 13

Using a 7/16" wrench, remove the flap valve assembly from the liquid chamber. Inspect flap valves for nicks, gouges, chemical attack or abrasive wear.

NOTE: Replace worn parts with genuine Wilden parts for reliable performance.

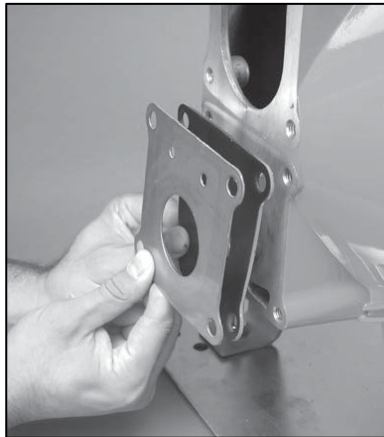

Step 14

Inspect manifold gasket, flap valve seat and seat gasket for nicks, gouges, chemical attack or abrasive wear.



Step 15

Using a 9/16" wrench, remove the fasteners that connect the remaining discharge elbow to the liquid chamber.

DISASSEMBLY / REASSEMBLY

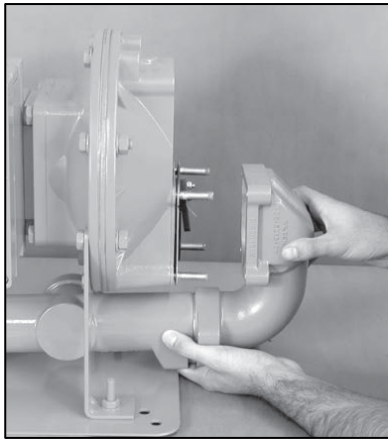

Step 16

Remove the discharge elbow and discharge T-section from the liquid chamber. This will allow for easy removal of the flap valve assembly. Inspect for nicks, gouges, chemical attack or abrasive wear.

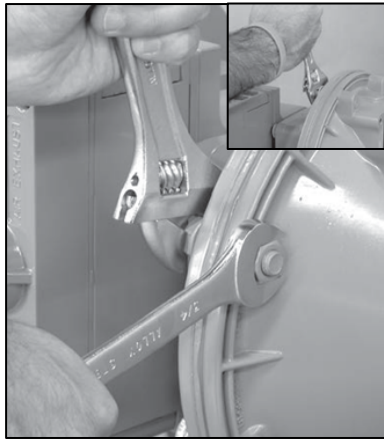

Step 17

Using a 5/8" wrench and an adjustable wrench, remove the fasteners that connect the liquid chambers to the center section.

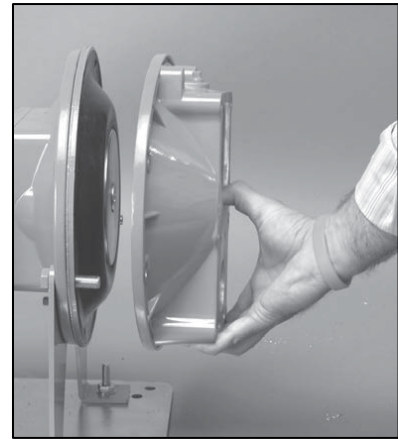

Step 18

Remove the liquid chamber to expose the diaphragm and outer piston.

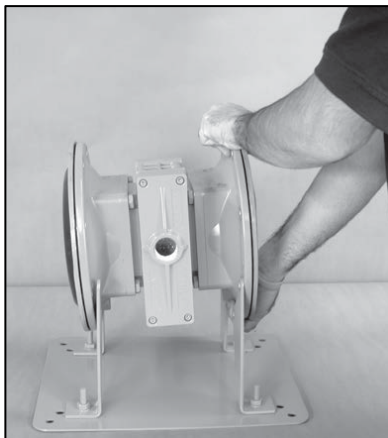

Step 19

Next, remove center section assembly from pump stand.



Step 20

Using two (2) 3/8" hex-head wrenches, loosen the outer piston from the main shaft.

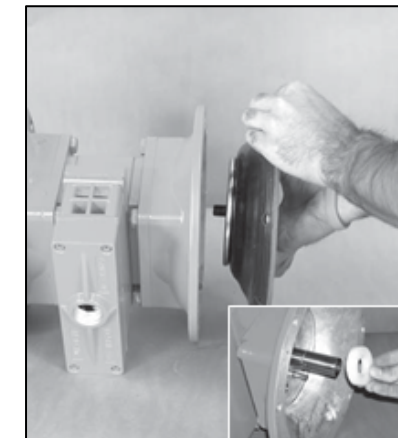

Step 21

After loosening the outer piston from the main shaft, the diaphragm assembly and bumper can be removed from the center section.

DISASSEMBLY / REASSEMBLY

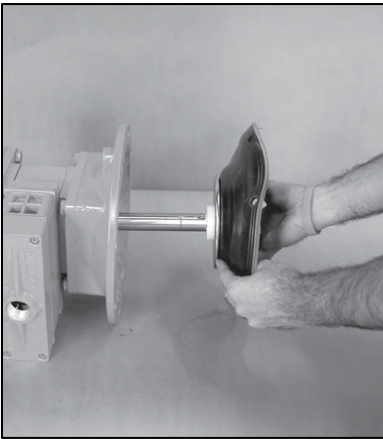

Step 22

Next, remove the remaining diaphragm/piston assembly, bumper and main shaft from the center section.

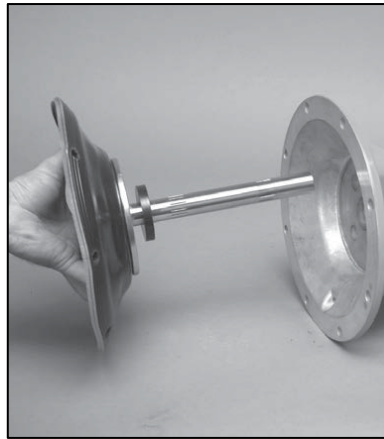

Step 23

Remove the inner piston from the diaphragm/piston assembly by turning counterclockwise.

DISASSEMBLY / REASSEMBLY

AIR VALVE / CENTER SECTION DISASSEMBLY

Tools Required:

- 3/16" Hex-Head Wrench
- 1/4" Hex-Head Wrench
- Snap-Ring Pliers
- O-Ring Pick



CAUTION: Before attempting any maintenance or repair, disconnect the compressed air line to the pump and allow all air pressure to bleed from the pump. Disconnect all intake, discharge, and air lines. Drain the pump by turning it upside down and allowing any fluid to flow into a suitable container. Be aware of any hazardous effects of contact with your process fluid.



NOTE: Replace worn parts with genuine Wilden parts for reliable performance.



NOTE: For pump Air Valves fitted with Pump Cycle Monitor (PCMI) units, if the Set Screw is removed from the Air Valve Spool and/or the Sensor is removed from the Air Valve End Cap, refer to PCMI EOM WIL-19130-E for reassembly instructions.



Step 1

Using a pair of snap-ring pliers, remove the snap ring from the pilot sleeve.



Step 2

Using an O-ring pick, remove the O-ring from modulator spool.



Step 3

Using the appropriate-sized wrench, loosen and remove the fasteners that attach the air chamber to the center section.



Step 4

Lift the air chamber away from the center section and remove the center block gasket. Replace gasket, if necessary.



Step 5

Turn the assembly over and remove the pilot spool sleeve from the center section.

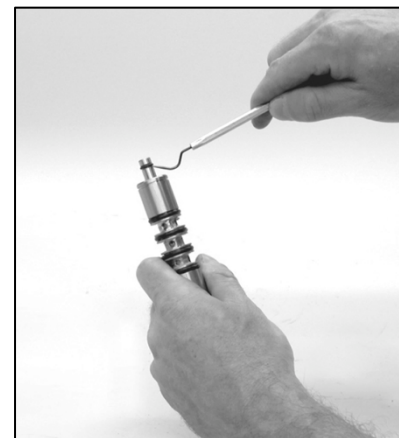

Step 6

Using an O-ring pick, gently remove the O-ring from the opposite side of the dimpled end of the pilot spool.

DISASSEMBLY / REASSEMBLY

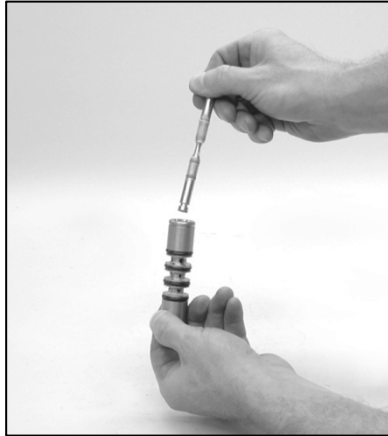

Step 7

Gently remove the pilot spool from the sleeve and inspect for nicks, wear or damage. Replace the pilot spool assembly or sleeve O-rings, if necessary. During reassembly, never insert the dimpled end of the pilot spool first. This will damage the single urethane O-ring by passing it over the ports in the pilot sleeve.

NOTE: Do not remove seals from the assembly. Seals are not sold separately.



Step 8

Remove the modulator spool from the center section. Check for wear to the spool or O-rings and replace, if necessary.



Step 9

Using the appropriate-sized wrench, loosen the fasteners and lift away remaining air chamber and center block gasket from center section. Replace gasket if necessary.

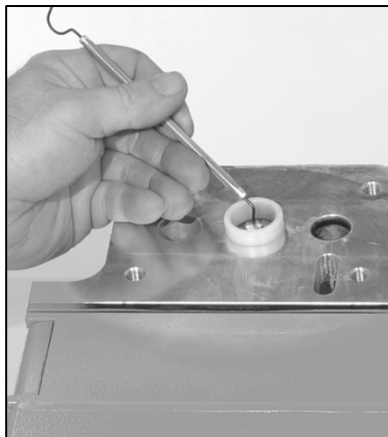

Step 10

Using an O-ring pick, remove the two (2) shaft bushings from center block. Inspect and replace if necessary. Using an O-ring pick, gently remove the two (2) Glyd™ rings from the center block. Inspect and replace if necessary.

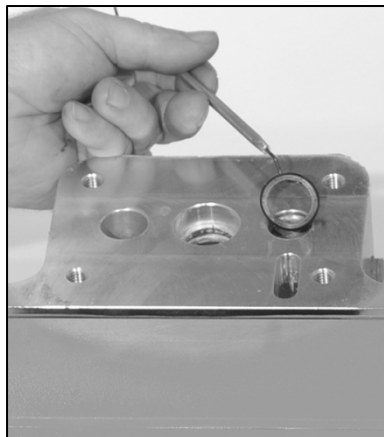

Step 11

Using an O-ring pick, remove the two (2) Glyd™ rings from modulator spool bore. Inspect and replace if necessary.

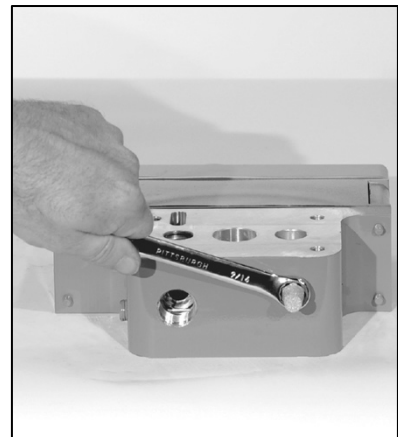

Step 12

Using an appropriate-sized wrench, remove the pilot exhaust muffler. Inspect for damage or contamination and replace if necessary.

DISASSEMBLY / REASSEMBLY

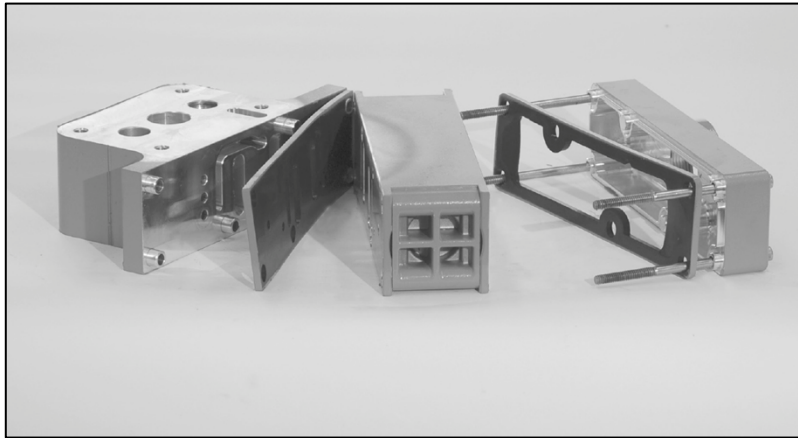

Step 13

Loosen and remove the four (4) air valve bolts from the center section assembly.

Lift the muffer plate and muffer plate gasket away from the center block. Inspect for wear and replace, if necessary.

Lift the air valve assembly and remove the air valve gasket. Inspect the gasket and replace, if necessary.

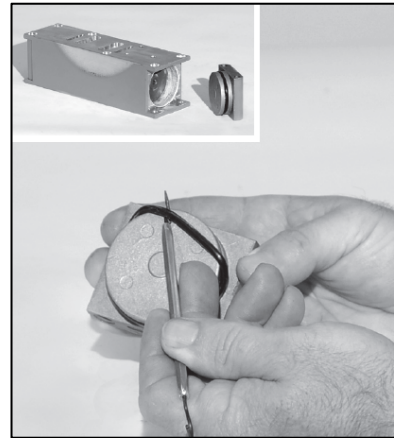

Step 14

Remove the air valve end cap to expose the air valve spool by lifting up on the end cap. Inspect the O-ring on the end cap using an O-ring pick. Replace the O-ring(s), if necessary.

NOTE: The Pro-Flo SHIFT air valve incorporates an end cap at both ends of the air valve.

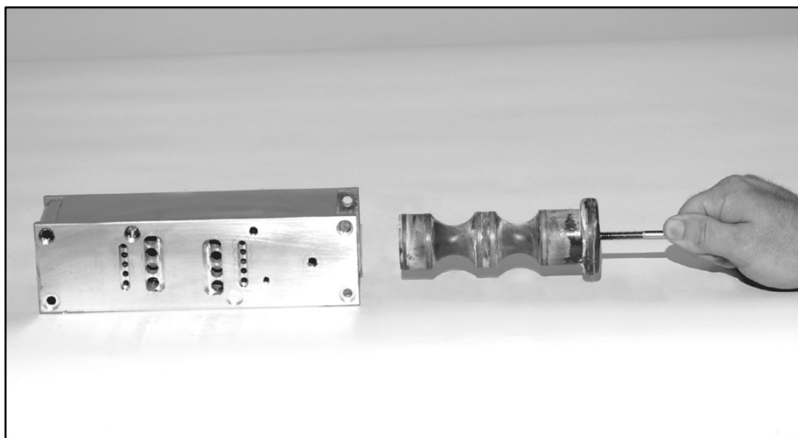

Step 15

Remove the air valve spool from the air valve body by threading one air valve bolt into the end of the air valve spool and gently sliding the spool out of the air valve body. Inspect seals for signs of wear and replace the entire air valve assembly, if necessary. Re-insert the spool immediately into the air valve body after inspection because the seals expand and cannot be reinserted after a length of time.

NOTE: Do not remove seals from the assembly. Seals are not sold separately.

DISASSEMBLY / REASSEMBLY

SINGLE-POINT EXHAUST

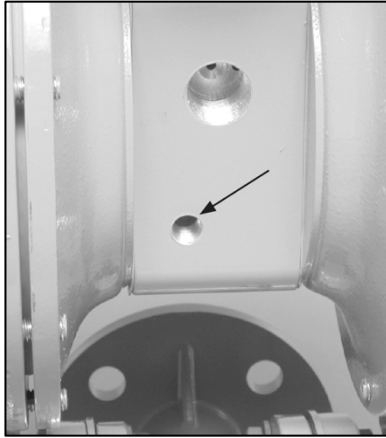

Step 1

Remove the pilot exhaust muffer in the pilot bleed port located at the front of the center block. Install 1/4" NPT pipe plug (00-7010-08) into the bleed port.

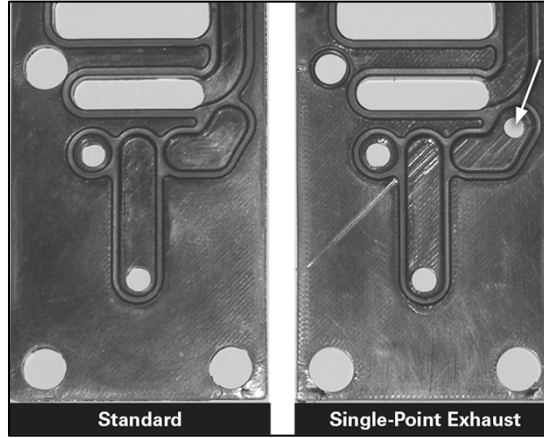

Step 2

Optional: Install a single-point exhaust gasket (04-2639-52). The single-point air valve gasket can be purchased as a spare part or included with the purchase of a new Pro-Flo SHIFT pump.

REASSEMBLY HINTS & TIPS

Upon performing applicable maintenance to the air distribution system, the pump can now be reassembled. Please refer to the disassembly instructions for photos and parts placement.

To reassemble the pump, follow the disassembly instructions in reverse order. The air distribution system needs to be assembled first, then the diaphragms and finally the wetted path. The applicable torque specifications are on this page.

The following tips will assist in the assembly process:

- Lubricate the air valve bore, center section shaft and pilot spool bore with NLGI grade 2 white EP bearing grease or equivalent.
- Clean the inside of the center section shaft bore to ensure no damage is done to new shaft seals.
- A small amount of NLGI grade 2 white EP bearing grease can be applied to the muffer and air valve gaskets to lubricate gaskets during assembly.
- Make sure that the exhaust port on the muffer plate is centered between the two exhaust ports on the center section.
- Stainless bolts should be lubed to reduce the possibility of seizing during tightening.

Maximum Torque Specifications	
Description	Torque
Air Valve	13.6 N•m (120 in-lb)
Center Block to Air Chamber	27.1N•m (20 ft-lb)
Outer Piston	54.2 N•m (40 ft-lb)
Flap Valve Assembly	1.7 N•m (15 in-lb)
Liquid Chamber to Air Chamber	32.5 N•m (24 ft-lb)
Manifold Elbow to Liquid Chamber	13.6 N•m (18 ft-lb)
Manifold Elbow to T-Section	20.3 N•m (15 ft-lb)

DISASSEMBLY / REASSEMBLY

SHAFT SEAL INSTALLATION

Pre-Installation

After all the old seals have been removed, the inside of the bushing should be cleaned to ensure no debris is left that may cause premature damage to the new seals.

Installation

1. To prevent damaging the inside surface of the new seal, wrap electrical tape around each leg of the needle-nose pliers. (Heat shrink tubing may also be used.)
2. With a new seal in hand, place the two legs of the needle-nose pliers inside the seal ring. (See Figure A.)
3. Open the pliers as wide as the seal diameter will allow, then with two fingers pull down on the top portion of the seal to form a kidney bean shape. (See Figure B.)
4. Lightly clamp the pliers together to hold the seal into the kidney shape. Be sure to pull the seal into as tight of a kidney shape as possible. This will allow the seal to travel down the bushing bore with greater ease.
5. With the seal clamped in the pliers, insert the seal into the bushing bore and position the bottom of the seal into the correct groove. When the bottom of the seal is seated in the groove, release the clamp pressure on the pliers. This will allow the seal to partially snap back to its original shape.
6. After removing the pliers, you will notice a slight bump in the seal shape. Before the seal can be resized properly, the bump in the seal should be removed as much as possible. This can be done with either a Phillips screwdriver or your finger. With the side of the screwdriver or your finger, apply light pressure to the peak of the bump. This pressure will cause the bump to be eliminated almost completely.
7. Lubricate the edge of the shaft with NLGI grade 2 white EP bearing grease.
8. Slowly insert the center shaft with a rotating motion. This will complete the resizing of the seal.
9. Repeat these steps for the remaining seals.

Tools

The following tools can be used to aid in the installation of the new seals:

- Needle-Nose Pliers
- Phillips Screwdriver
- Electrical Tape

Figure A

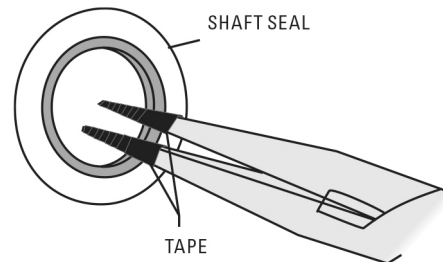
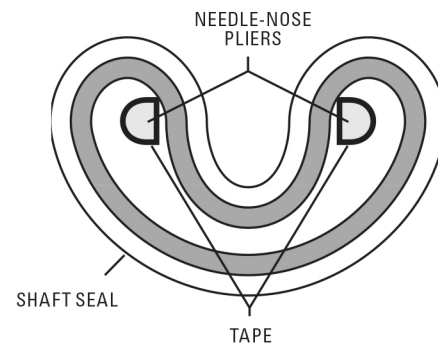

Figure B



SECTION 8

EXPLODED VIEW AND PARTS LIST

PS810 BRAHMA

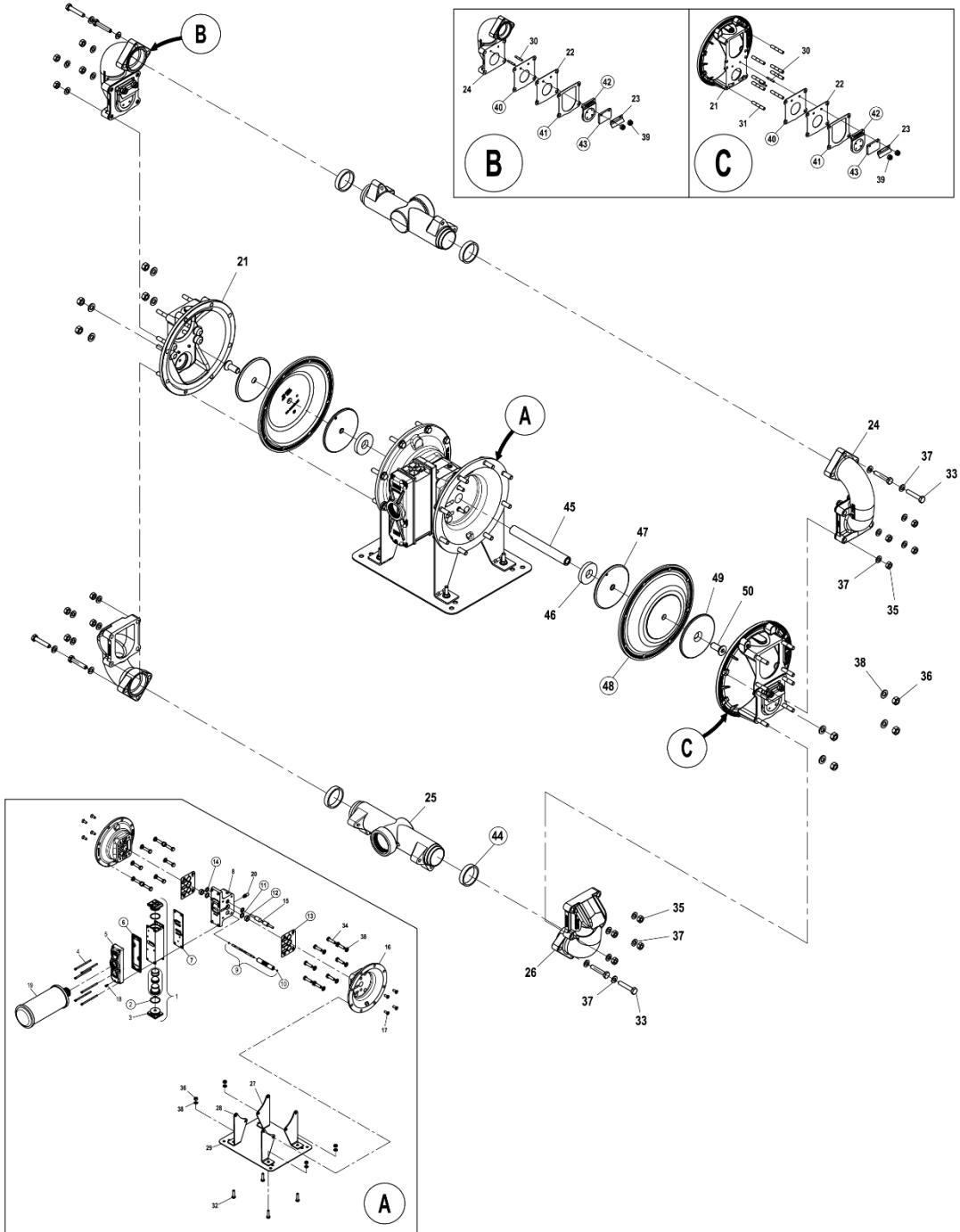

ALL CIRCLED PART IDENTIFIERS ARE INCLUDED IN REPAIR KITS

LW0282 Rev. C

EXPLODED VIEW AND PARTS LIST

Model Description		XPS810/ AMAAA/.../0677	XPS810/ WMAAA/.../0677
Item	Description	Item	P/N
Air Distribution Components			
1	Air Valve Assembly, Pro-Flo Shift™ 1	1	04-2039-01
2	O-Ring (-225), End Cap (Ø1.859 x Ø.139)	2	04-2390-52-700
3	End Cap	2	04-2340-01
4	Screw, SHC, Air Valve (1/4"-20 x 4 1/2")	6	01-6000-03
5	Muffler Plate, Pro-Flo Shift™	1	04-3189-01
6	Gasket, Muffler Plate, Pro-Flo Shift™	1	04-3509-56
7	Gasket, Air Valve, Pro-Flo Shift™	1	04-2639-56
8	Center Block Assembly, Pro-Flo Shift™ 2	1	15-3129-01
9	Pilot Sleeve Assembly	1	08-3894-99
10	O-Ring, Pilot Spool Retaining (-009, Ø.208" x Ø.070")	2	04-2650-49-700
11	Seal, Shaft	2	15-3210-55-225
12	Bushing, Shaft	2	15-3306-13
13	Gasket, Center Block Pro-Flo Shift™	2	04-3529-56
14	Seal, Air Control Spool	2	04-3219-49
15	Air Control Spool	1	08-3854-03
16	Air Chamber, Pro-Flo Shift™	2	08-3664-01
17	Screw, SFCHC (3/8"-16 x 1")	8	71-6250-08
18	Screw, Grounding, Self-tapping (10-32 x 1/2")	1	04-6345-08
19	Muffler 1-1/2" MNPT	1	04-3518-99R
20	Muffler 1/4" MNPT	1	04-3240-07
Wetted Path Components			
21	Chamber, Liquid	2	08-4985-01
22	Seat, Flap Valve	4	08-1150-08
23	Retainer, Flap Valve	4	08-1196-08
24	Elbow, Inlet	2	08-5215-01
25	T-Section (NPT)	2	08-5175-01
25	T-Section (BSPT)	2	08-5175-01-14
26	Elbow, Discharge	2	08-5255-01
27	Left - Hand Foot	2	08-5546-08
28	Right - Hand Foot	2	08-5545-08
29	Plate, Base	1	08-5550-08
30	Stud, Threaded (1/4"-20 x 1-1/2")	8	08-6162-08
31	Stud, Threaded (3/8"-16 x 2-1/2")	16	08-6161-08
32	Screw, HHC, (7/16"-14 X 1-3/16)	4	08-6195-08
33	Screw, HHC (3/8"-16 x 2-3/16")	8	08-6184-08
34	Screw, HHC (7/16"-14 x 1-3/4")	16	08-6194-08
35	Nut, Hex (3/8"-16)	16	02-6430-08
36	Nut, Hex (7/16"-14)	12	08-6427-08
37	Washer, Plain (Ø.406" x Ø.812" x .065")	24	15-6740-08-50
38	Washer, Plain (Ø.468" x Ø.922" x .065")	28	08-6734-08
39	Nut, Lock Hex (1/4"-20)	8	08-6477-08
Gaskets/Flap Valves/Flap Hinge/Manifold Seal Ring			
40	Gasket, Seat	4	*
41	Gasket, Manifold	4	*
42	Valve, Flap	4	*
43	Pad, Flap Valve Hinge	4	*
44	Ring, Manifold Sealing	4	*
Full Stroke Rubber Components			
45	Shaft	1	08-3807-03
46	Bumper	2	08-6902-23
47	Piston, Inner	2	08-3705-08
48	Diaphragm, Flap Valve	2	*
49	Piston, Outer	2	08-4555-08
50	Screw, SFCHC (5/8"-11 x 1-1/2")	2	08-6092-08

LW0283 REV. D

* See elastomer chart - Section 9

¹ Air Valve Assembly includes items 2 and 3.

² Center Block Assembly includes item 11, 12, 14 and 15.

All boldface items are primary wear parts.

Specialty Code 0677 = Horizontal Center Ported, NPT Threaded

Specialty Code 0678 = Horizontal Center Ported, BSPT Threaded

Specialty Code 0687 = Horizontal Center Ported, NPT Threaded, Single-Point Exhaust

Specialty Code 0688 = Horizontal Center Ported, BSPT Threaded, Single-Point Exhaust

EXPLODED VIEW AND PARTS LIST

PS1510 BRAHMA

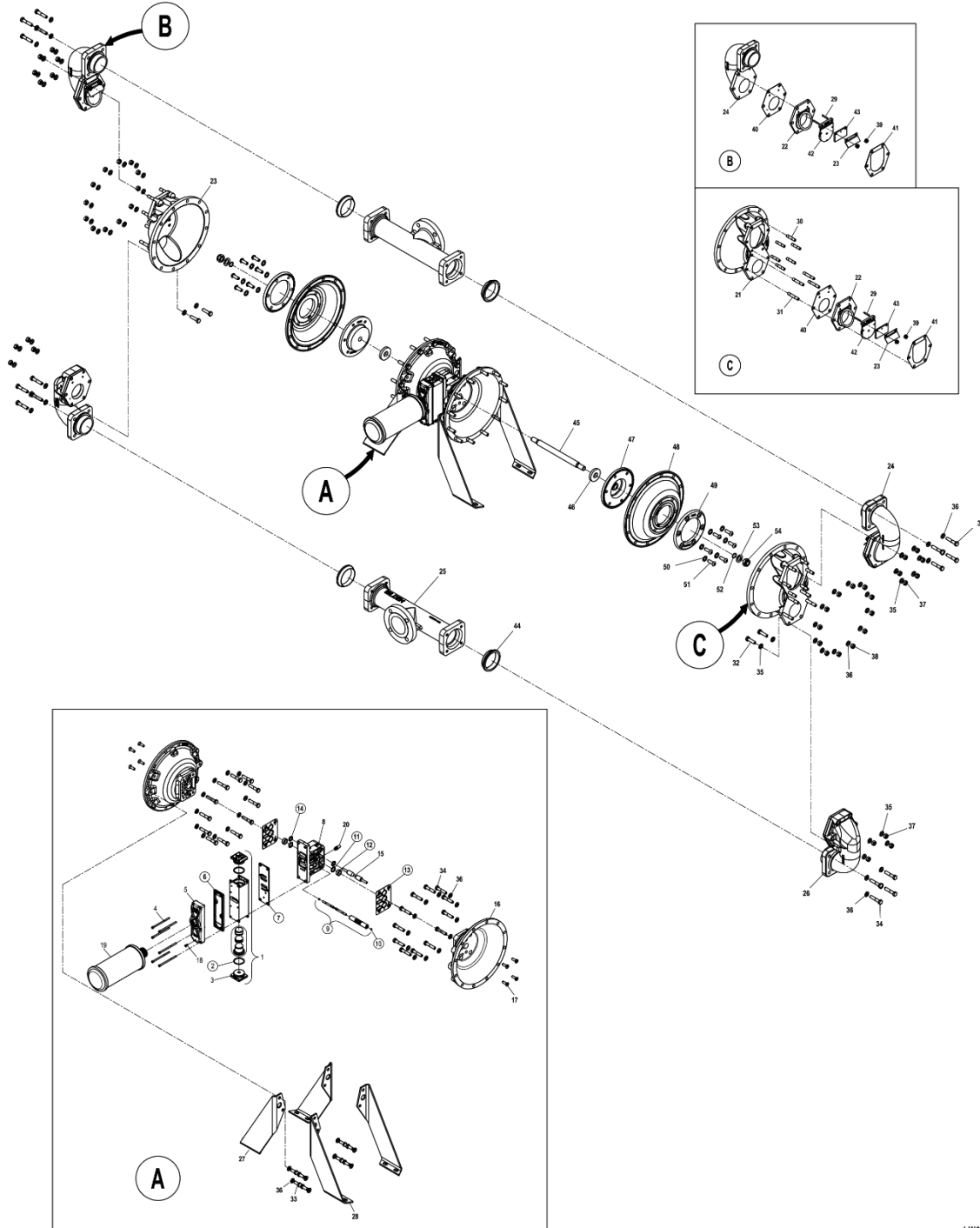

ALL CIRCLED PART IDENTIFIERS ARE INCLUDED IN REPAIR KITS

LW0285 Rev. C

EXPLODED VIEW AND PARTS LIST

		Model Description	XPS1510/ AAAAA/...	XPS1510/ WWAAA/...
Item	Description	Item	P/N	P/N
Air Distribution Components				
1	Air Valve Assembly, Pro-Flo Shift™ 1	1	04-2039-01	
2	O-Ring (-225), End Cap (Ø1.859 x Ø.139)	2	04-2390-52-700	
3	End Cap	2	04-2340-01	
4	Screw, SHC, Air Valve (1/4"-20 x 4 1/2")	6	01-6000-03	
5	Muffler Plate, Pro-Flo Shift™	1	04-3189-01	
6	Gasket, Muffler Plate, Pro-Flo Shift™	1	04-3509-56	
7	Gasket, Air Valve, Pro-Flo Shift™	1	04-2639-56	
8	Center Block Assembly, Pro-Flo Shift™ 2	1	15-3129-01	
9	Pilot Sleeve Assembly	1	08-3894-99	
10	O-Ring, Pilot Spool Retaining (-009, Ø.208" x Ø.070")	2	04-2650-49-700	
11	Seal, Shaft	2	15-3210-55-225	
12	Bushing, Shaft	2	15-3306-13	
13	Gasket, Center Block Pro-Flo Shift™	2	04-3529-56	
14	Seal, Air Control Spool	2	04-3219-49	
15	Air Control Spool	1	15-3854-03	
16	Air Chamber, Pro-Flo Shift™	2	15-3664-01	
17	Screw, SFCHC (3/8"-16 x 1")	8	71-6250-08	
18	Screw, Grounding, Self-tapping (10-32 x 1/2")	1	04-6345-08	
19	Muffler 1-1/2" MNPT	1	04-3518-99R	
20	Muffler 1/4" MNPT	1	04-3240-07	
Wetted Path Components				
21	Chamber, Liquid	2	15-4985-01	15-4985-02
22	Seat, Flap Valve	4	15-1150-01	15-1150-02
23	Retainer, Flap Valve	4		15-1196-08
24	Elbow, Inlet	2	15-5215-01	15-5215-02
25	T-Section (ANSI)	2	15-5175-01	15-5175-02
	T-Section (DIN)	2	15-5176-01	15-5176-02
26	Elbow, Discharge	2	15-5255-01	15-5255-02
27	Left - Hand Foot	2		15-5546-08
28	Right - Hand Foot	2		15-5545-08
29	Stud, Threaded (1/4"-20 x 1-1/2")	8		08-6162-08
30	Stud, Threaded (7/16"-14 x 2-3/8")	12		15-6161-08
31	Stud, Threaded (7/16"-14 x 3-3/16")	8		15-6162-08
32	Screw, HHC (7/16"-14 x 1-3/4")	4		08-6194-08
33	Screw, HHC (1/2"-13 x 1")	8		08-6132-08
34	Screw, HHC (1/2"-13 x 2-3/8")	40		15-6184-08
35	Washer, Plain (7/16")	24		08-6734-08
36	Washer, Plain (1/2")	72		04-6730-08
37	Nut, Hex (7/16"-14)	20		08-6427-08
38	Nut, Hex (1/2"-13)	24		15-6420-08
39	Nut, Lock Hex (1/4"-20)	8		08-6477-08
Gaskets/Flap Valves/Flap Hinge/Manifold Seal Ring				
40	Gasket, Seat	4		*
41	Gasket, Manifold	4		*
42	Valve, Flap	4		*
43	Pad, Flap Valve Hinge	4		*
44	Ring, Manifold Sealing	4		*
Full Stroke Rubber Components				
45	Shaft	1	15-3807-03	
46	Bumper	2	08-6902-23	
47	Piston, Inner	2	15-3705-01	15-3705-02
48	Diaphragm, Flap Valve	2		*
49	Piston, Outer	2	15-4555-01	15-4555-02
50	Washer, Brass (.63 ID x 1.00 OD x .05)	12		15-6741-07
51	Screw, BHC (1/2"-13 x 1-3/8")	12		15-6194-08
52	Washer, Plain (3/4")	2		15-6743-08
53	Washer, Brass (.79 ID x .98 OD x .04)	2		15-6742-07
54	Nut, Lock Hex (3/4"-10)	2		15-6461-08

LW0286 REV. D

* See elastomer chart - Section 9

¹ Air Valve Assembly includes items 2 and 3.

² Center Block Assembly includes item 11, 12, 14 and 15.

All boldface items are primary wear parts

Specialty Code 0504 = Horizontal Center Ported, DIN-Flanged

Specialty Code 0320 = Single-Point Exhaust

Specialty Code 0323 = Single-Point Exhaust, DIN-Flanged

SECTION 9

ELASTOMER OPTIONS

PS810 BRAHMA

MATERIAL	DIAPHRAGM, FLAP VALVE	GASKET, SEAL	GASKET, MANIFOLD	VALVE, FLAP	PAD, FLAP VALVE HINGE	RING, MANIFOLD SEALING
Neoprene	08-1012-51	08-1395-51	08-1401-51	08-1185-51	08-1195-51	08-1305-51
Buna-N	08-1012-52	08-1395-52	08-1401-52	08-1185-52	08-1195-52	08-1305-52

LW0283 REV. D

PS1510 BRAHMA

MATERIAL	CHAMBER, LIQUID	GASKET, SEAT	GASKET, MANIFOLD	VALVE, FLAP	PAD, FLAP VALVE HINGE	RING, MANIFOLD SEALING
Neoprene	15-1012-51	15-1395-51	15-1401-51	15-1185-51	15-1195-51	15-1305-51
Buna-N	15-1012-52	15-1395-52	15-1401-52	15-1185-52	15-1195-52	15-1305-52

LW0286 REV. D

WILDEN®

PSG
22069 Van Buren Street
Grand Terrace, CA 92313-5651 USA
P: +1 (909) 422 -1730
psgdover.com



Where Innovation Flows

PSG® reserves the right to modify the information and illustrations contained in this document without prior notice. This is a non-contractual document.