

SALES & ENGINEERING DATA

RATIO SERIES: **1:1**

FLUID P.S.I. RANGE: **10 - 100**

PD07P-XPS-PXX

3/4" NON-METALLIC DIAPHRAGM PUMP

RELEASED: 12-4-06
 REVISED: 6-8-10
 (REV. 03) S-1409

DIMENSIONAL DATA

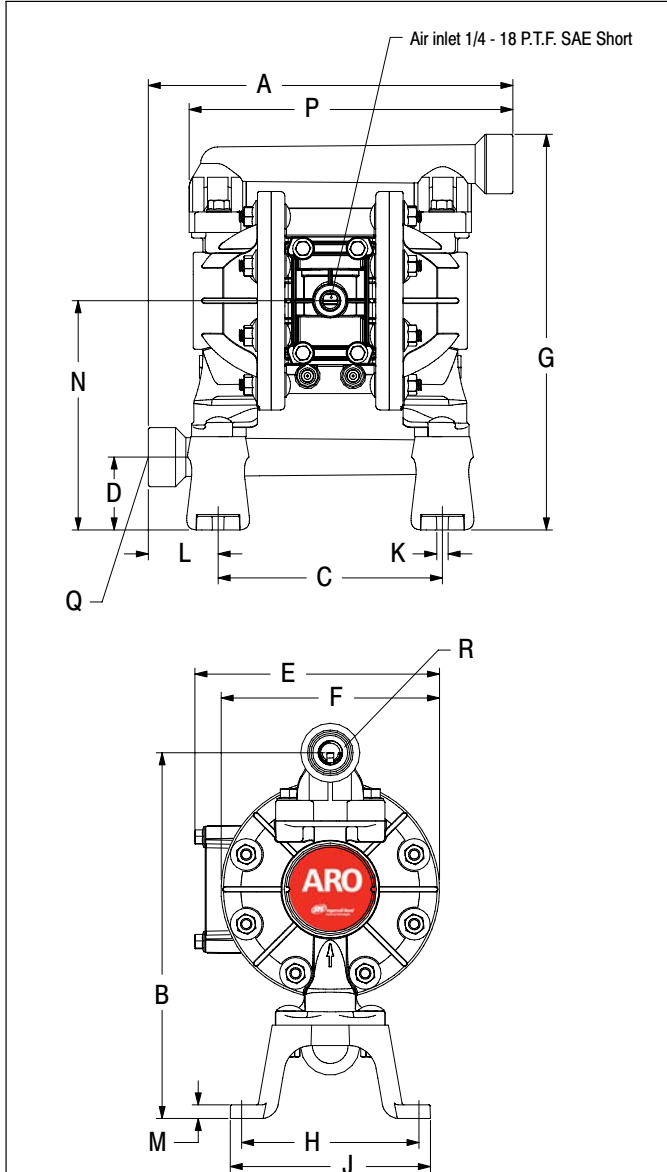

DIMENSIONS

A - 10-1/16" (254.2 mm)	F - 6-1/32" (153.1 mm)	L - 1-15/16" (48.9 mm)
B - 10-3/32" (256.1 mm)	G - 10-29/32" (276.8 mm)	M - 3/8" (9.6 mm)
C - 6-3/16" (157.1 mm)	H - 4-29/32" (124.2 mm)	N - 6-5/16" (160.5 mm)
D - 2" (51.0 mm)	J - 5-17/32" (140.2 mm)	P - 8-7/8" (225.3 mm)
E - 6-3/4" (171.0 mm)	K - 5/16" (8.0 mm)	

Model	"Q" Material Inlet	"R" Material Outlet
PD07P-APS-PXX	3/4 - 14 N.P.T.F. - 1	3/4 - 14 N.P.T.F. - 1
PD07P-BPS-PXX	Rp 3/4 (3/4 - 14 BSP)	Rp 3/4 (3/4 - 14 BSP)

NOTE: Dimensions are shown in inches and (mm) and are supplied for reference only.

SPECIFICATIONS

CONSTRUCTION

Model Series	PD07P-XPS-PXX
Pump Type	Non-Metallic, Air Operated, Double Diaphragm
Ratio	1:1
Material Inlet / Outlet (female)	
PD07P-APS-PXX	3/4 - 14 N.P.T.F. - 1
PD07P-BPS-PXX	Rp 3/4 (3/4 - 14 BSP parallel)
Air Inlet (female)	1/4 - 18 P.T.F. SAE short
Air Exhaust (standard)	internal
(optional)(female)	3/8 - 18 N.P.T.F. - 1
Weight	5.61 lbs (2.54 kgs)
Air Section Service Kit	637428
Fluid Section Service Kit	637427-XX

PD07P-XPS- P
637427 -
 Diaphragm Material
 Ball Material
 EXAMPLE: Model #PD07P-APS-PAA
 Fluid Section Service Kit is 637427-AA

PERFORMANCE

Air Inlet Pressure Range	10 - 100 p.s.i. (0.69 - 6.9 bar)
Maximum Material Inlet Pressure	10 p.s.i. (0.69 bar)
Fluid Outlet Pressure Range	10 - 100 p.s.i. (0.69 - 6.9 bar)
Maximum Flow Rate (flooded inlet)	14.8 g.p.m. (56.0 l.p.m.)
Displacement / Cycle @ 100 p.s.i.	0.032 gal. (0.12 lit.)
Maximum Particle Size	3/32" dia. (2.4 mm)
Maximum Temperature Limits (diaphragm / ball / seat material)	
Hytel	-20° to 150° F (-29° to 66° C)
Polypropylene	35° to 150° F (2° to 66° C)
Santoprene	-40° to 225° F (-40° to 107° C)
PTFE	40° to 225° F (4° to 107° C)
Noise Level @ 70 p.s.i. - 60 c.p.m.①	75.0 db(A)②

Notes:

- ① Tested with 67367 muffler assembly installed.
- ② The pump sound pressure level has been updated to an Equivalent Continuous Sound Level (L_{Aeq}) to meet the intent of ANSI S1. 13-1971, CAGI-PNEUROP S5.1 using four microphone locations.

ACCESSORIES:

- 66073-1 Air Line Connection Kit
- 637438 Ported Exhaust Kit
- 93110 Muffler

INGERSOLL RAND COMPANY LTD

209 NORTH MAIN STREET - BRYAN, OHIO 43506

☎ (800) 495-0276 • FAX(800) 892-6276

© 2010

CCN 15277205

www.ingersollrandproducts.com

ARO

IR Ingersoll Rand
 Industrial Technologies

PERFORMANCE CURVES

PD07P-XPS-PXX 3/4" NON-METALLIC DIAPHRAGM PUMP

