

EOM

ENGINEERING OPERATION
& MAINTENANCE

P1 Clamped Plastic Pump

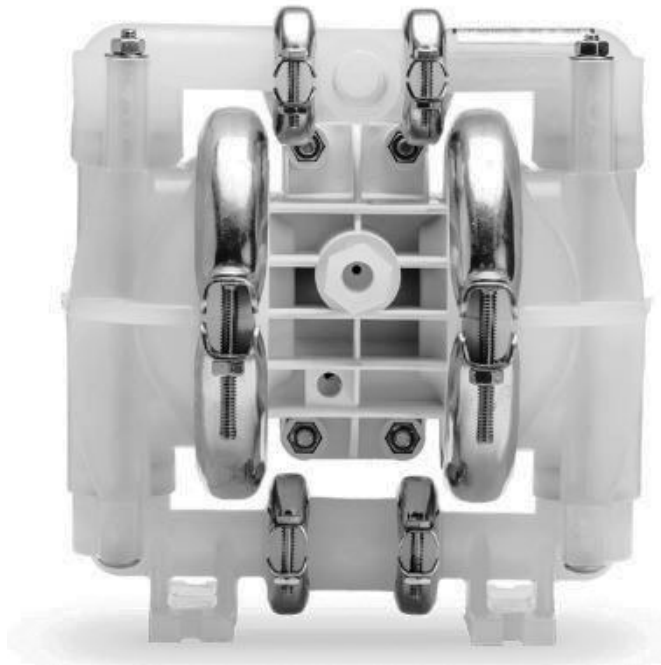

Where Innovation Flows



Contents

Section 1: Precautions - Read First!	4
Section 2: Wilden Pump Designation System	5
Section 3: How It Works—Pump & Air Distribution System	6
Section 4: Dimensional Drawings	7
P1 Plastic.....	7
Section 5: Performance	8
P1 Plastic Rubber-Fitted.....	8
P1 Plastic TPE-Fitted.....	8
P1 Plastic PTFE-Fitted.....	9
Suction-Lift Curves.....	10
Section 6: Suggested Installation, Operation, Maintenance and Troubleshooting	11
Section 7: Disassembly / Reassembly	14
Pump Disassembly.....	14
Single-Piece Manifold Disassembly/Reassembly.....	18
Air Valve / Center Section Disassembly.....	20
Reassembly Hints & Tips.....	22
Section 8: Exploded View and Parts List	24
P1 Plastic Rubber-Fitted.....	24
P1 Plastic PTFE-Fitted.....	26
Section 9: Elastomer Options	28

Copyright

Copyright 2018 PSG®, a Dover Company. All rights reserved.

PSG reserves the right to modify the information and illustrations in this document without prior notice. The product described in this document is furnished under a license agreement or nondisclosure agreement. No part of this document may be reproduced, stored in a retrieval system, or transmitted in any form or any means electronic or mechanical, including photocopying and recording, without the written permission of PSG, a Dover Company, except as described by the terms of those agreements.

This is a non-contractual document. 01-2019.

Trademarks

PSG and the PSG logo are registered trademarks of PSG. Wilden® is a registered trademark of PSG California LLC. Pro-Flo® SHIFT, Pro-Flo®, and Wil-Flex® are registered trademarks of PSG California LLC. Chem-Fuse™, Pure-Fuse™, Saniflex™, and Bunalast™ are trademarks of PSG California LLC.

All trademarks, names, logos and service marks (collectively "trademarks") in this document are registered and unregistered trademarks of their respective owners. Nothing contained in this document should be construed as granting any license or right to use any trademark without the prior written permission of the trademark owner.

Warranty

Each and every product manufactured by Wilden is built to meet the highest standards of quality. Every pump is functionally tested to insure integrity of operation. Wilden warrants that pumps, accessories and parts manufactured or supplied by it to be free from defects in material and workmanship for a period of five (5) years from date of installation or six (6) years from date of manufacture, whichever comes first.

For more information, and to register your Wilden pump for warranty, please visit <https://www.psgdover.com/wilden/support/warranty-registration>.

Certifications



Section 1

Precautions - Read First!

 **CAUTION:** Do not apply compressed air to the exhaust port — pump will not function

 **CAUTION:** Do not over-lubricate air supply — excess lubrication will reduce pump performance. Pump is pre-lubed

 **TEMPERATURE LIMITS:**

Polypropylene	0°C to 79.4°C	32°F to 175°F
PVDF	-12.2°C to 107.2°C	10°F to 225°F
Neoprene	-17.8°C to 93.3°C	0°F to 200°F
Buna-N	-12.2°C to 82.2°C	10°F to 180°F
EPDM	-51.1°C to 137.8°C	-60°F to 280°F
FKM	-40°C to 176.7°C	-40°F to 350°F
Wil-Flex®	-40°C to 107.2°C	-40°F to 225°F
Saniflex™	-28.9°C to 104.4°C	-20°F to 220°F
Polyurethane	-12.2°C to 65.6°C	10°F to 150°F
Tetra-Flex™ PTFE w/Neoprene Backed	4.4°C to 107.2°C	40°F to 225°F
Tetra-Flex™ PTFE w/EPDM Backed	-10°C to 137.8°C	14°F to 280°F
PTFE	4.4°C to 104.4°C	40°F to 220°F

NOTE: Not all materials are available for all models. Refer to Section 2 for material options for your pump.

 **CAUTION:** When choosing pump materials, be sure to check the temperature limits for all wetted components. Example: FKM has a maximum limit of 176.7°C (350°F) but polypropylene has a maximum limit of only 79.4°C (175°F).

 **CAUTION:** Maximum temperature limits are based upon mechanical stress only. Certain chemicals will significantly reduce maximum safe operating temperatures. Consult Chemical Resistance Guide (E4) for chemical compatibility and temperature limits.

 **WARNING:** Prevention of static sparking — If static sparking occurs, fire or explosion could result. Pump, valves, and containers must be grounded to a proper grounding point when handling flammable fluids and whenever discharge of static electricity is a hazard.

 **CAUTION:** Do not exceed 8.6 bar (125 psig) air supply pressure.

 **CAUTION:** The process fluid and cleaning fluids must be chemically compatible with all wetted pump components (see E4).

 **CAUTION:** Pumps should be thoroughly flushed before installing into process lines. FDA and USDA approved pumps should be cleaned and/ or sanitized before being used.

 **CAUTION:** Always wear safety glasses when operating pump. If diaphragm rupture occurs, material being pumped may be forced out air exhaust.

 **CAUTION:** Before any maintenance or repair is attempted, the compressed air line to the pump should be disconnected and all air pressure allowed to bleed from pump. Disconnect all intake, discharge and air lines. Drain the pump by turning it upside down and allowing any fluid to flow into a suitable container

 **CAUTION :** Blow out air line for 10 to 20 seconds before attaching to pump to make sure all pipeline debris is clear. Use an in-line air filter. A 5µ (micron) air filter is recommended

 **NOTE:** Before starting disassembly, mark a line from each liquid chamber to its corresponding air chamber. This line will assist in proper alignment during reassembly.

 **CAUTION:** Pro-Flo® pumps cannot be used in submersible applications. Pro-Flo V™ is available in both submersible and non-submersible options. Do not use non-submersible Pro-Flo V™ models in submersible applications. Turbo-Flo™ pumps can be used in submersible applications.

 **CAUTION:** Tighten all hardware prior to installation.

Section 2

WILDEN PUMP DESIGNATION SYSTEM

P1 ORIGINAL™ PLASTIC

13 mm (1/2") Pump
Maximum Flow Rate:
56.8 lpm (15.0 gpm)

LEGEND

P1 / X X X X X / XXX / XX / X XX / XXXX

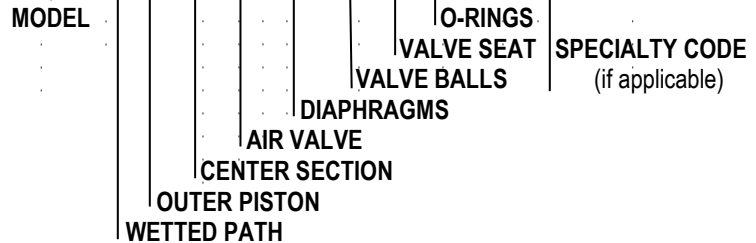

MATERIAL CODES

MODEL

P1 = PRO-FLO®

WETTED PATH

K = PVDF
P = POLYPROPYLENE

OUTER PISTON

K = PVDF
P = POLYPROPYLENE
Z = NO OUTER PISTON

CENTER SECTION

LL = ACETAL
PP = POLYPROPYLENE

AIR VALVE

P = POLYPROPYLENE

DIAPHRAGMS

BNS = BUNA-N (Red Dot)
FSS = SANIFLEX™ [Hytre® (Cream)]
PUS = POLYURETHANE (Clear)
THU = PTFE W/HIGH-TEMP
BUNA-N BACK-UP
TEU = PTFE W/EPDM
BACK-UP (White)
TNL = PTFE W/NEOPRENE
BACK-UP O-RING,
IPD (White)
TVU = PTFE W/NEOPRENE
BACK-UP (White)
VTS = FKM (White Dot)
WFS = WIL-FLEX® [Santoprene®
(Orange Dot)]

VALVE BALLS

BN = BUNA-N (Red Dot)
FS = SANIFLEX™ [Hytre® (Cream)]
PU = POLYURETHANE (Brown)
TF = PTFE (White)
VT = FKM (White Dot)
WF = WIL-FLEX® [Santoprene®
(OrangeDot)]

VALVE SEATS

K = PVDF

VALVE SEAT O-RING

BN = BUNA-N
FS = SANIFLEX™ [Hytre® (Cream)]
PU = POLYURETHANE (Brown)
TV = PTFE ENCAP. FKM
WF = WIL-FLEX® [Santoprene®]

SPECIALTY CODES

- 0100 Wil-Gard II™ 110V
- 0102 Wil-Gard II™ sensor wires ONLY
- 0103 Wil-Gard II™ 220V
- 0206 PFA coated hardware,
Wil-Gard II™ sensor wires ONLY
- 0502 PFA coated hardware
- 0603 PFA coated hardware, Wil-Gard II™ 110V
- 0608 PFA coated hardware, Wil-Gard II™ 220V

NOTE: Most elastomeric materials use colored dots for identification.

NOTE: Not all models are available with all material options.

Hytre® is a registered trademark of DuPont Dow Elastomers.

Section 3

HOW IT WORKS — PUMP

The Wilden diaphragm pump is an air-operated, placement, self-priming pump. These drawings show the flow pattern through the pump upon its initial stroke. It is assumed the pump has no fluid in it prior to its initial stroke.

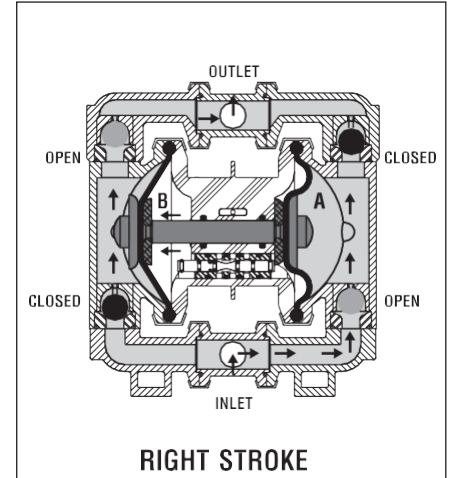
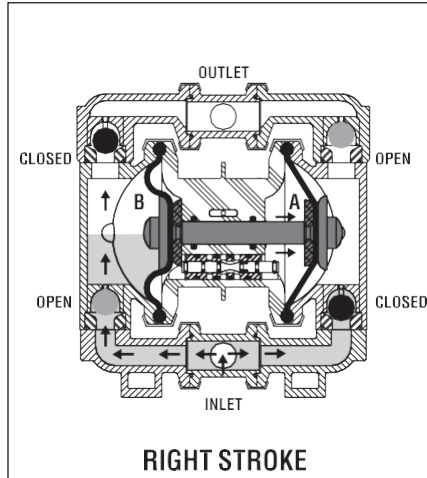
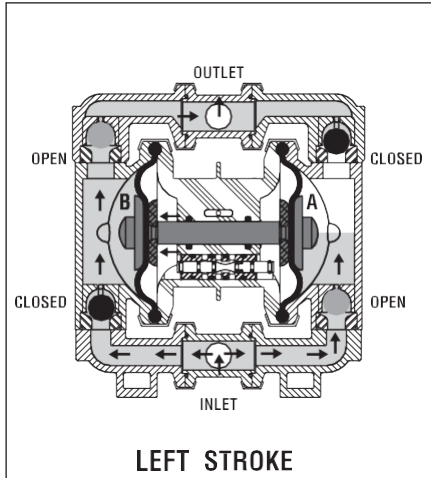

FIGURE 1 The air valve directs pressurized air to the back side of diaphragm A. The compressed air is applied directly to the liquid column separated by elastomeric diaphragms. The diaphragm acts as a separation membrane between the compressed air and liquid, balancing the load and removing mechanical stress from the diaphragm. The compressed air moves the diaphragm away from the center block of the pump. The opposite diaphragm is pulled in by the shaft connected to the pressurized diaphragm. Diaphragm B is on its suction stroke; air behind the diaphragm has been forced out to the atmosphere through the exhaust port of the pump. The movement of diaphragm B toward the center block of the pump creates a vacuum within chamber B. Atmospheric pressure forces fluid into the inlet manifold forcing the inlet valve ball off its seat. Liquid is free to move past the inlet valve ball and fill the liquid chamber (see shaded area).

FIGURE 2 When the pressurized diaphragm, diaphragm A, reaches the limit of its discharge stroke, the air valve redirects pressurized air to the back side of diaphragm B. The pressurized air forces diaphragm B away from the center block while pulling diaphragm A to the center block. Diaphragm B is now on its discharge stroke. Diaphragm B forces the inlet valve ball onto its seat due to the hydraulic forces developed in the liquid chamber and manifold of the pump. These same hydraulic forces lift the discharge valve ball off its seat, while the opposite discharge valve ball is forced onto its seat, forcing fluid to flow through the pump discharge. The movement of diaphragm A toward the center block of the pump creates a vacuum within liquid chamber A. Atmospheric pressure forces fluid into the inlet manifold of the pump. The inlet valve ball is forced off its seat allowing the fluid being pumped to fill the liquid chamber.

FIGURE 3 At completion of the stroke, the air valve again redirects air to the back side of diaphragm A, which starts diaphragm B on its exhaust stroke. As the pump reaches its original starting point, each diaphragm has gone through one exhaust and one discharge stroke. This constitutes one complete pumping cycle. The pump may take several cycles to completely prime depending on the conditions of the application.

HOW IT WORKS — AIR DISTRIBUTION SYSTEM

Figure A

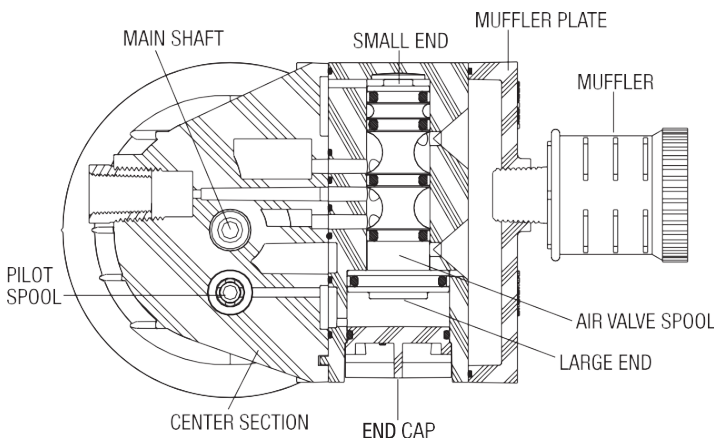

The Pro-Flo® patented air distribution system incorporates two moving parts: the air valve spool and the pilot spool. The heart of the system is the air valve spool and air valve. This valve design incorporates an unbalanced spool. The smaller end of the spool is pressurized continuously, while the large end is alternately pressurized then exhausted to move the spool. The spool directs pressurized air to one air chamber while exhausting the other. The air causes the main shaft/diaphragm assembly to shift to one side — discharging liquid on that side and pulling liquid in on the other side. When the shaft reaches the end of its stroke, the inner piston actuates the pilot spool, which pressurizes and exhausts the large end of the air valve spool. The repositioning of the air valve spool routes the air to the other air chamber.

DIMENSIONAL DRAWING

P1 Plastic

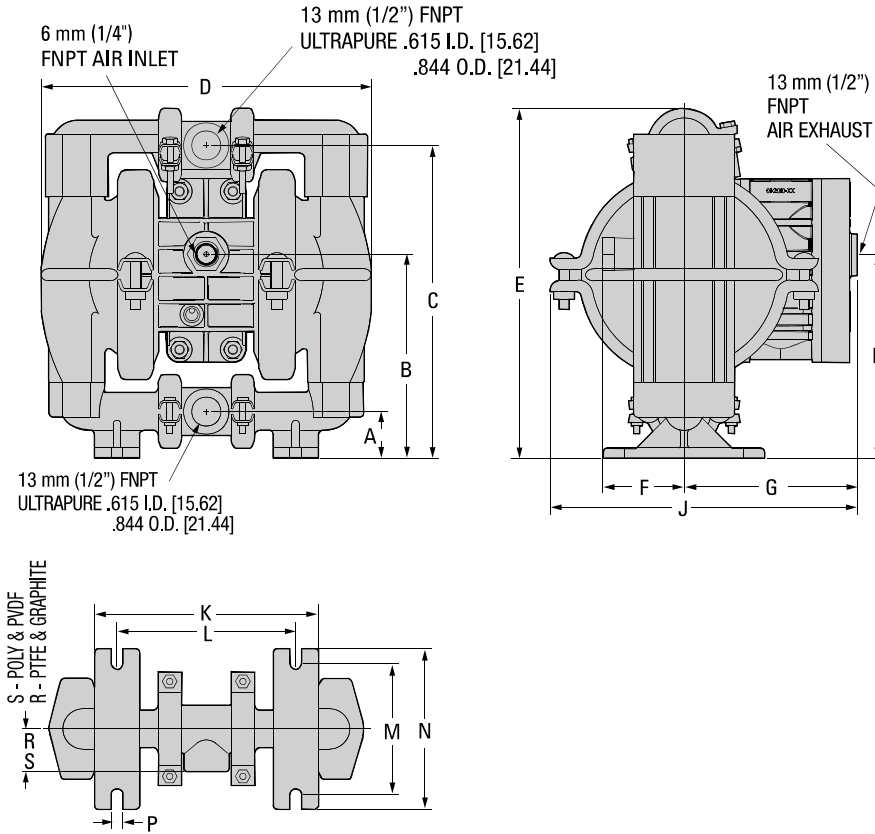

DIMENSIONS

ITEM	METRIC (mm)	STANDARD (inch)
A	31	1.2
B	130	5.1
C	196	7.7
D	208	8.2
E	218	8.6
F	56	2.2
G	114	4.5
H	127	5.0
J	203	8.0
K	145	5.7
L	114	4.5
M	84	3.3
N	102	4.0
P	8	0.3
R	20	0.8
S	28	1.1

SUCTION LIFT CURVES

P1 PLASTIC SUCTION - LIFT CAPABILITY

Suction lift curves are calibrated for pumps operating at 305 m (1,000') above sea level. This chart is meant to be a guide only. There are many variables which can affect your pump's operating characteristics. The number of intake and discharge elbows, viscosity of pumping fluid, elevation (atmospheric pressure) and pipe friction loss all affect the amount of suction lift your pump will attain.

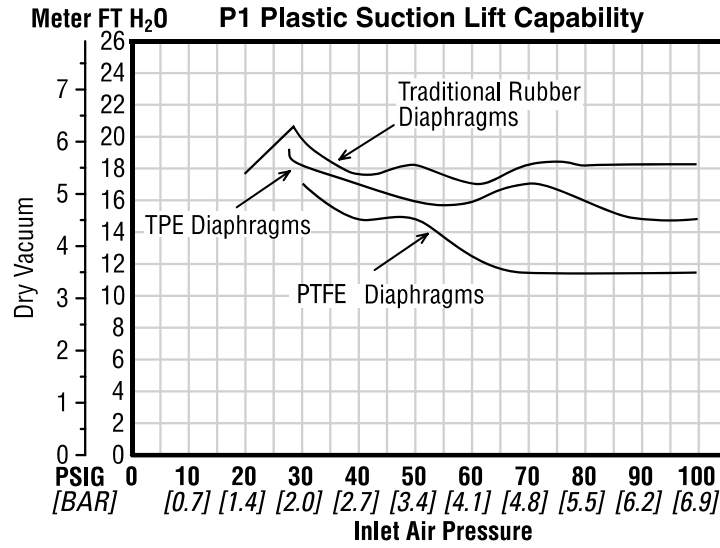

Section 6

Suggested Installation, Operation, Maintenance and Troubleshooting

The Pro-Flo® model P1 has a 13 mm (1/2") inlet and 13 mm (1/2") outlet and is designed for flows to 56.8 lpm (15 gpm). The P1 Plastic pump is manufactured with wetted parts of pure, unpigmented PVDF, PTFE PFA or polypropylene. The P1 Plastic is constructed with a polypropylene center section. A variety of diaphragms and o-rings are available to satisfy temperature, chemical compatibility, abrasion and flex concerns.

The suction pipe size should be at least 13 mm (1/2") diameter or larger if highly viscous material is being pumped. The suction hose must be non-collapsible, reinforced type as the P1 is capable of pulling a high vacuum. Discharge piping should be at least 13 mm (1/2"); larger diameter can be used to reduce friction losses. It is critical that all fittings and connections are airtight or a reduction or loss of pump suction capability will result.

 **CAUTION:** All fittings and connections must be airtight. Otherwise, pump suction capability will be reduced or lost.

Months of careful planning, study and selection efforts can result in unsatisfactory pump performance if installation details are left to chance. You can avoid premature failure and long-term dissatisfaction by exercising reasonable care throughout the installation process.

Location

Noise, safety and other logistical factors usually dictate where equipment will be situated on the production floor. Multiple installations with conflicting requirements can result in congestion of utility areas, leaving few choices for additional pumps.

Within the framework of these and other existing conditions, every pump should be located in such a way that several key factors are balanced against each other to maximum advantage.

- **Access:** First of all, the location should be accessible. If it's easy to reach the pump, maintenance personnel will have an easier time carrying out routine inspections and adjustments. Should major repairs become necessary, ease of access can play a key role in speeding the repair process and reducing total downtime.
- **Air Supply:** Every pump location should have an air line large enough to supply the volume of air necessary to achieve the desired pumping rate. Use air pressure up to a maximum of 8.6 bar (125 psig) depending on pumping requirements.

For best results, the pumps should use a 5µ (micron) air filter, needle valve and regulator. The use of an air filter before the pump will ensure that the majority of any pipeline contaminants will be eliminated.

- **Solenoid Operation:** When operation is controlled by a solenoid valve in the air line, three-way valves should be used. This valve allows trapped air between the valve and the pump to bleed off which improves pump performance. Pumping volume can be estimated by counting the number of strokes per minute and then multiplying the figure by the displacement per stroke.
- **Muffler:** Sound levels are reduced below OSHA specifications using the standard Wilden muffler. Other mufflers can be used to further reduce sound levels, but they usually reduce pump performance.

- **Elevation:** Selecting a site that is well within the pump's dynamic-lift capability will assure that loss-of-prime issues will be eliminated. In addition, pump efficiency can be adversely affected if proper attention is not given to site location.

- **Piping:** Final determination of the pump site should not be made until the piping challenges of each possible location have been evaluated. The impact of current and future installations should be considered ahead of time to make sure that inadvertent restrictions are not created for any remaining sites.

The best choice possible will be a site involving the shortest and straightest hook-up of suction and discharge piping. Unnecessary elbows, bends and fittings should be avoided. Pipe sizes should be selected to keep friction losses within practical limits. All piping should be supported independently of the pump. In addition, the piping should be aligned to avoid placing stress on the pump fittings.

Flexible hose can be installed to aid in absorbing the forces created by the natural reciprocating action of the pump. If the pump is to be bolted down to a solid location, a mounting pad placed between the pump and the foundation will assist in minimizing pump vibration. Flexible connections between the pump and rigid piping will also assist in minimizing pump vibration. If quick-closing valves are installed at any point in the discharge system, or if pulsation within a system becomes a problem, a surge suppressor (SD Equalizer®) should be installed to protect the pump, piping and gauges from surges and water hammer.

 **NOTE:** Materials of construction and elastomer material have an effect on suction-lift parameters. Please refer to the performance section for specifics.

When pumps are installed in applications involving flooded suction or suction-head pressures, a gate valve should be installed in the suction line to permit closing of the line for pump service.

For P1 Plastic models, a non-raised surfaced-flange adapter should be utilized when mating to the pump's inlet and discharge manifolds for proper sealing.

If the pump is to be used in a self-priming application, be sure that all connections are airtight and that the suction lift is within the model's ability. Note: Materials of construction and elastomer material have an effect on suction lift parameters. Please consult Wilden distributors for specifics.

The model P1 plastic will pass 1.6 mm (1/16") solids. Whenever the possibility exists that larger solid objects may be sucked into the pump.

 **CAUTION:** Do not exceed 8.6 bar (125 psig) air supply pressure.

Suggested Installation, Operation, Maintenance and Troubleshooting

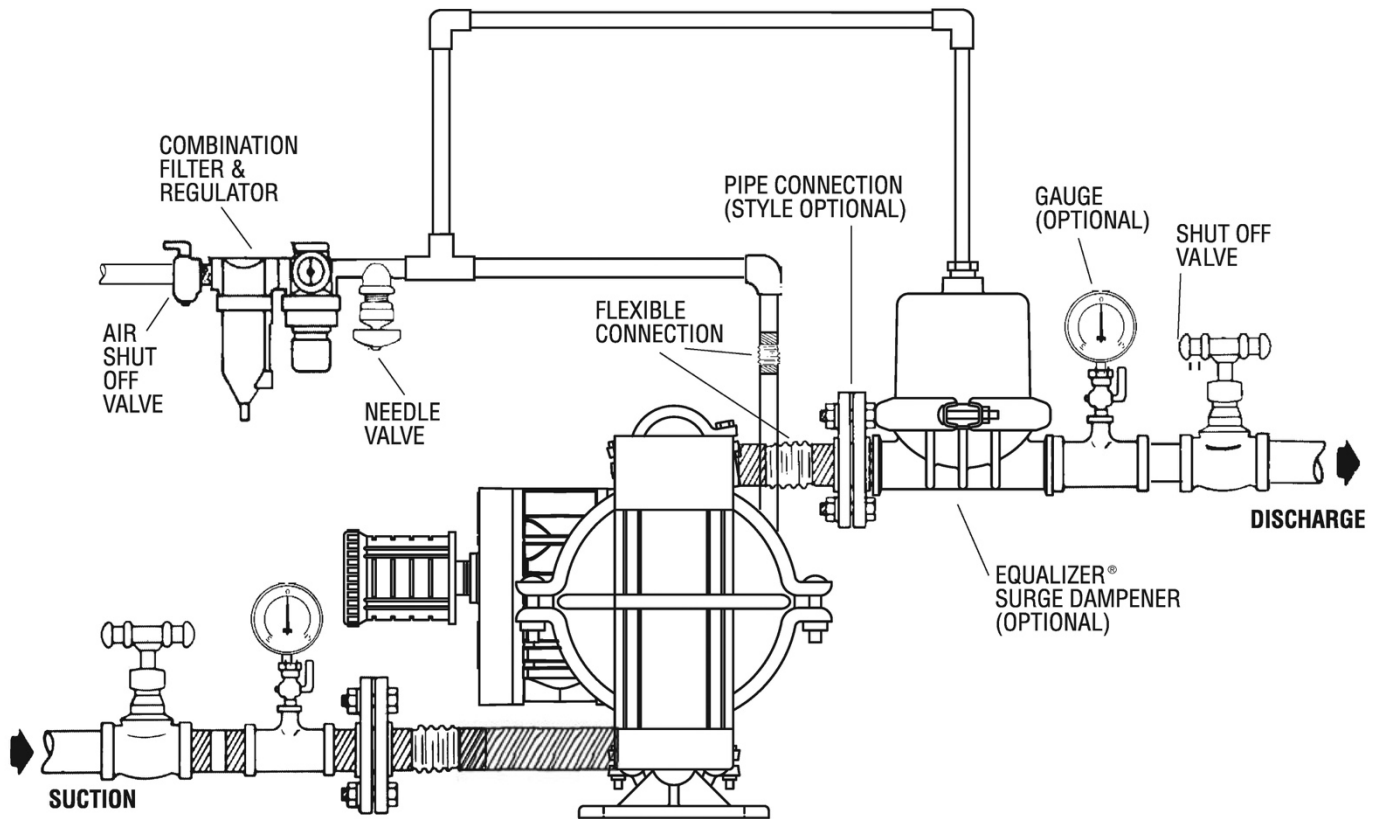

NOTE: In the event of a power failure, the shut-off valve should be closed, if the restarting of the pump is not desirable once power is regained.

Air-Operated Pumps: To stop the pump from operating in an emergency situation, simply close the shut-off valve (user-supplied) installed in the air supply line. A properly functioning valve will stop the air supply to the pump, therefore stopping output. This shut-off valve should be located far enough away from the pumping equipment such that it can be reached safely in an emergency situation

Operation

The P1 Advanced™ plastic is permanently lubricated and does not require in-line lubrication. Additional lubrication will not damage the pump, however if the pump is heavily lubricated by an external source, the pump's internal lubrication may be washed away. If the pump is then moved to a non-lubricated location, it may need to be disassembled and re-lubricated as described in the ASSEMBLY/DISASSEMBLY INSTRUCTIONS.

Pump discharge rate can be controlled by limiting the volume and/or pressure of the air supply to the pump. An air regulator is used to regulate air pressure. A needle valve is used to regulate volume. Pump discharge rate can also be controlled by throttling the pump

discharge by partially closing a valve in the discharge line of the pump. This action increases friction loss which reduces flow rate. (See Section 5.) This is useful when the need exists to control the pump from a remote location. When the pump discharge pressure equals or exceeds the air supply pressure, the pump will stop; no bypass or pressure relief valve is needed, and pump damage will not occur. The pump has reached a "deadhead" situation and can be restarted by reducing the fluid discharge pressure or increasing the air inlet pressure. Wilden Pro-Flo® pumps run solely on compressed air and do not generate heat; therefore, your process fluid temperature will not be affected.

Maintenance and Inspections

Since each application is unique, maintenance schedules may be different for every pump. Frequency of use, line pressure, viscosity and abrasiveness of process fluid all affect the parts life of a Wilden pump. Periodic inspections have been found to offer the best means for preventing unscheduled pump downtime. Personnel familiar with the pump's construction and service should be informed of any abnormalities that are detected during operation.

Suggested Installation, Operation, Maintenance and Troubleshooting

Troubleshooting

Pump will not run or runs slowly.

1. Ensure that the air inlet pressure is at least 0.3 bar (5psig) above start up pressure and that the differential pressure (the difference between air inlet and liquid discharge pressures) is not less than 0.7 bar (10psig).
2. Check air inlet filter for debris (see SUGGESTED INSTALLATION).
3. Check for extreme air leakage (blow by) that would indicate worn seals/boreds in the air valve, pilot spool and main shaft.
4. Disassemble pump and check for obstructions in the air passageways or objects that would obstruct the movement of internal parts.
5. Check for sticking ball check valves. If material being pumped is not compatible with pump elastomers, swelling may occur. Replace ball check valves and seals with proper elastomers. Also, as the check valve balls wear out, they become smaller and can become stuck in the seats. In this case, replace balls and seats.
6. Check for broken inner piston that will cause the air valve spool to be unable to shift.
7. Remove plug from pilot spool exhaust.

Pump runs but little or no product flows.

1. Check for pump cavitation; slow pump speed down to allow thick material to flow into liquid chambers.
2. Verify that vacuum required to lift liquid is not greater than the vapor pressure of the material being pumped (cavitation).

3. Check for sticking ball check valves. If material being pumped is not compatible with pump elastomers, swelling may occur. Replace ball check valves and seats with proper elastomers. Also, as the check valve balls wear out, they become smaller and can become stuck in the seats. In this case, replace balls and seats.

Pump air valve freezes.

1. Check for excessive moisture in compressed air. Either install a dryer or hot-air generator for compressed air. Alternatively, a coalescing filter may be used to remove the water from the compressed air in some applications.

Air bubbles in pump discharge.

1. Check for ruptured diaphragm.
2. Check tightness of outer pistons (refer to Section 7).
3. Check tightness of fasteners and integrity of O-rings and seals, especially at intake manifold.
4. Ensure pipe connections are airtight.

Product comes out air exhaust.

1. Check for diaphragm rupture.
2. Check tightness of outer pistons to shaft.

Section 7

Disassembly / Reassembly

Pump Disassembly

Tools Required:

- 8 mm (5/16") Wrench
- 5 mm (3/16") Allen Wrench
- 10 mm (3/8") Wrench
- 11 mm (7/16") Wrench Adjustable Wrench
- Vise equipped with soft jaws (such as plywood, plastic or other suitable material)



CAUTION: Before any maintenance or repair is attempted, the compressed air line to the pump should be disconnected and all air pressure allowed to bleed from the pump. Disconnect all intake, discharge, and air lines. Drain the pump by turning it upside down and allowing any fluid to flow into a suitable container. Be aware of any hazardous effects of contact with your process fluid.

The Wilden model P1 has a 13 mm (1/2") inlet and outlet and is designed for flows up to 56.8 lpm (15 gpm). The single-piece center section, consisting of center block and air chambers, is molded of polypropylene or acetal. All fasteners and hardware are stainless steel and the air valve is manufactured of brass or high-tech engineered thermoplastic. Its air distribution system is based on a revolutionary design, which offers economical reliability and performance. The model P1 Plastic is available in injection-molded polypropylene, PVDF and PTFE PFA wetted parts.

PLEASE read all directions before starting disassembly.



NOTE: The model used for these instructions incorporates rubber diaphragms, balls, and seats. Models with PTFE diaphragms, balls and seats are the same except where noted.



NOTE: Replace worn parts with genuine Wilden parts for reliable performance.

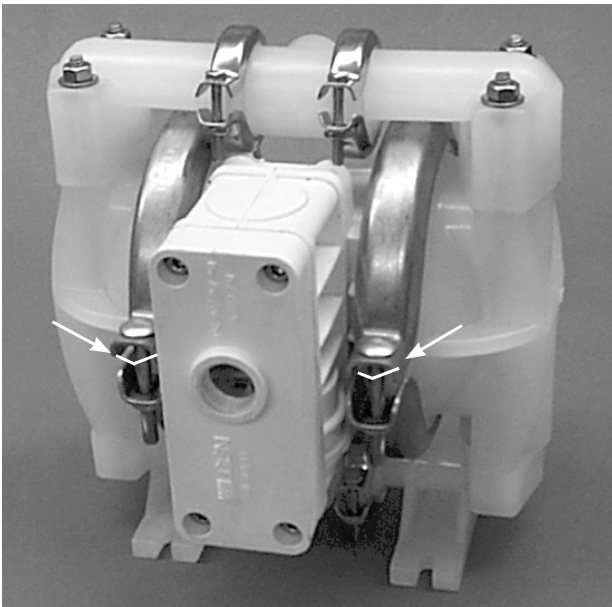

Step 1

Before starting disassembly, mark a line from each liquid chamber to its corresponding air chamber. This line will assist in proper alignment during reassembly.

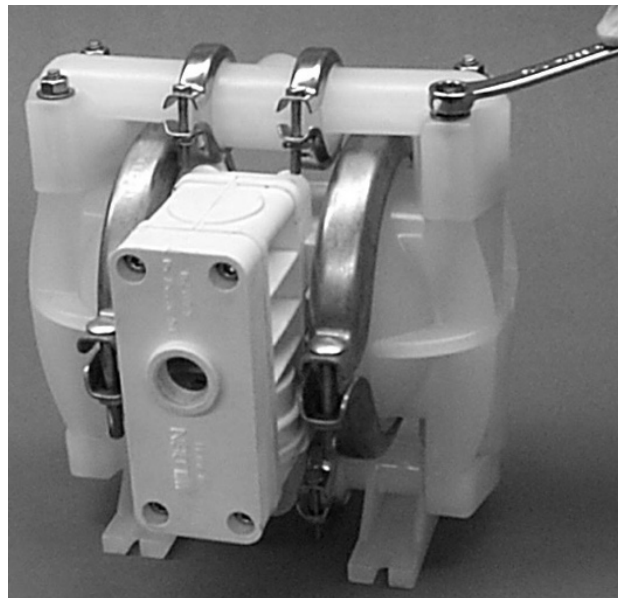

Step 2

Utilizing the 10 mm (3/8") box wrench, start by removing the four long carriage bolts that hold the top and bottom manifolds to the center section.

Disassembly / Reassembly

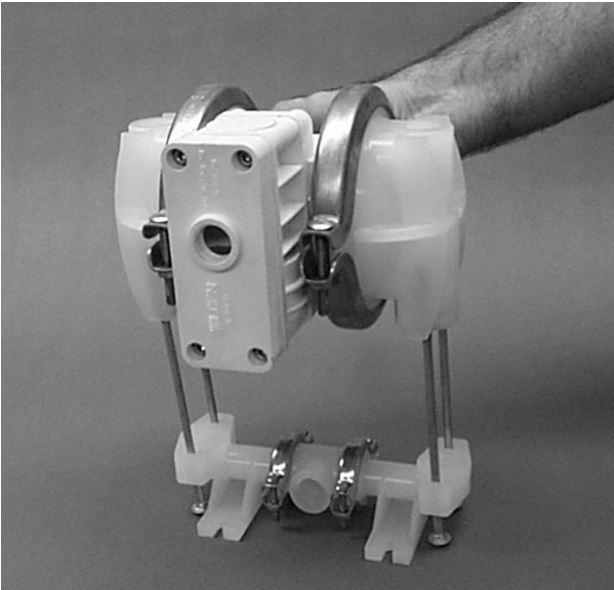

Step 3

Remove the top manifold and lift the center section off the inlet manifold.

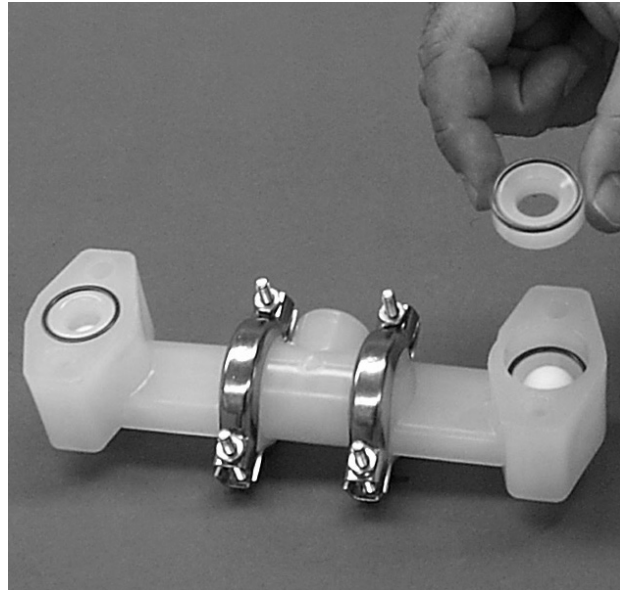

Step 4

Remove the discharge valve balls, seats and o-rings from the discharge manifold and inspect for nicks, gouges, chemical attack or abrasive wear. Replace worn parts with genuine Wilden parts for reliable performance. PTFE o-rings should be replaced when reassembled.

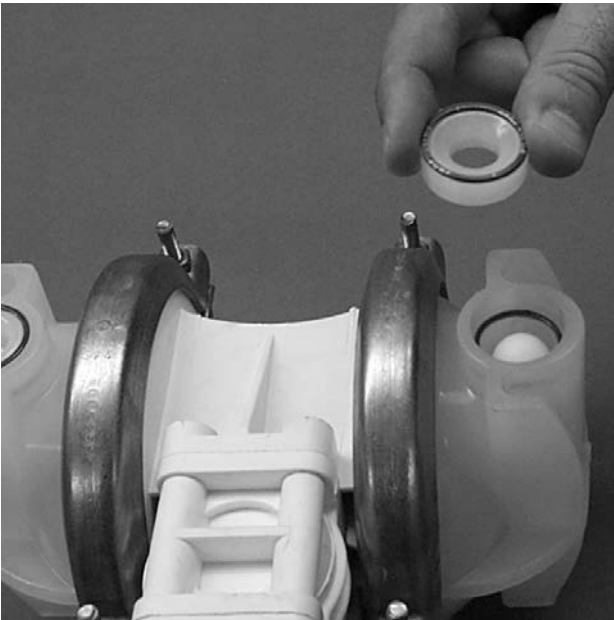

Step 5

Remove and inspect the ball retainer, retainer o-ring, and valve ball from the bottom of the liquid chamber. Check for nicks, gouges, chemical attack or abrasive wear. Replace worn parts with genuine Wilden parts for reliable performance. PTFE o-rings should be replaced when reassembled.

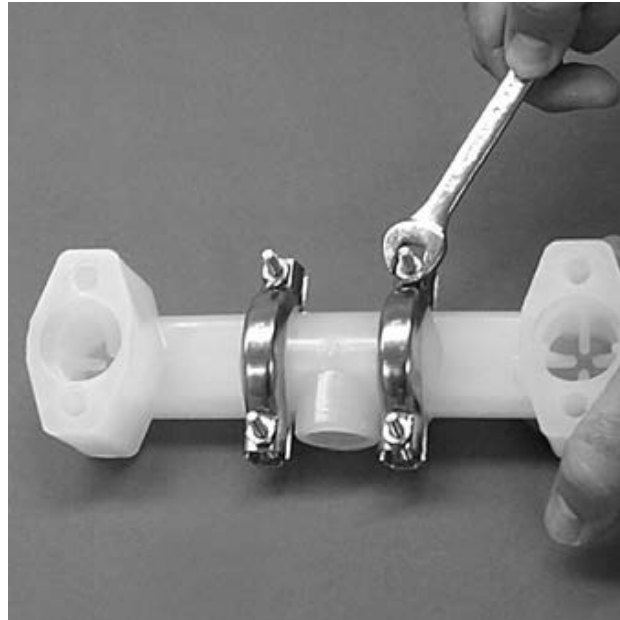

Step 6

Normally the inlet and discharge manifold should not be disassembled during regular pump maintenance. Should this be necessary completely remove and disassemble manifold clamp bands.

Disassembly / Reassembly



Step 7

Inspect o-rings for wear or damage and replace if necessary. PTFE o-rings should be replaced when reassembled.



Step 8

Use a 11 mm (7/16") wrench to remove one set of clamp bands that secure one liquid chamber to the one-piece center section.

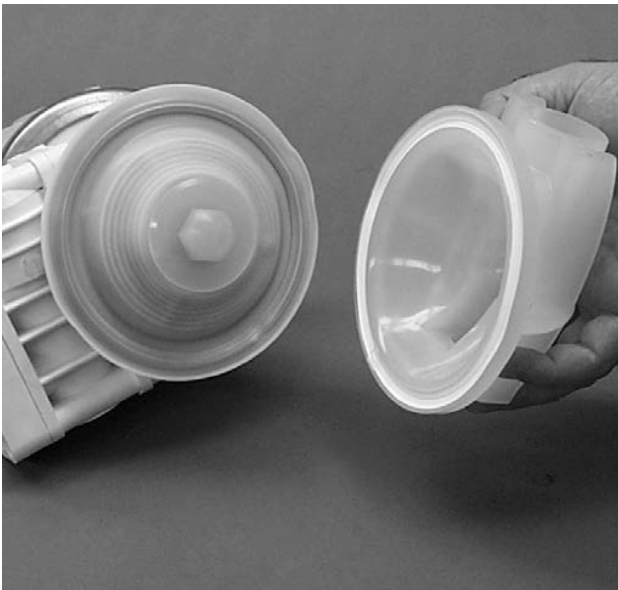

Step 9

Lift the liquid chamber away from the center section to expose the diaphragm and outer piston.



Step 10

Using an adjustable wrench, or by rotating the diaphragm by hand, remove the diaphragm assembly from the center section.

Disassembly / Reassembly



Step 11A

NOTE: Due to varying torque values, one of the following two situations may occur:

1) The outer piston, diaphragm and inner piston remain attached to the shaft and the entire assembly can be removed from the center section.

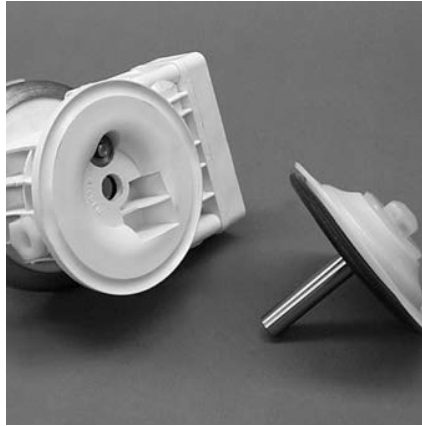

Step 11B

2) The outer piston, diaphragm, inner piston, and disc spring separate from the shaft which remains connected to the opposite side diaphragm assembly. PTFE-fitted pumps come standard with back-up diaphragms (not shown).

NOTE: Disc spring not shown on *Figure 11B*.

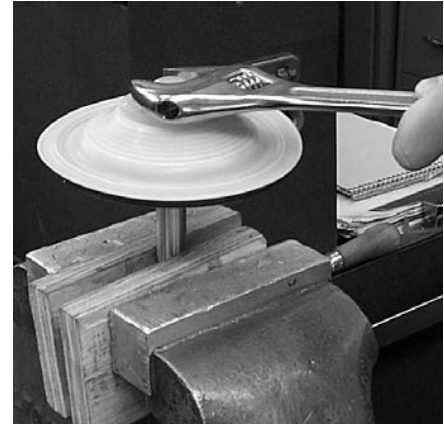

Step 12

To remove the diaphragm assembly from the shaft, secure shaft with soft jaws (a vise fitted with plywood or other suitable material) to ensure shaft is not nicked, scratched, or gouged. Using an adjustable wrench, remove diaphragm assembly from shaft. Inspect all parts for wear and replace with genuine Wilden parts if necessary.

Disassembly / Reassembly

Single-Piece Manifold

Tools Required:

- 5 mm (3/16") Allen Wrench
- 8 mm (5/16") Allen Wrench
- 9/16" Allen Wrench
- 11 mm (7/16") Wrench
- Two open end adjustable Wrenches
- O-Ring pick



CAUTION: Before any maintenance or repair is attempted, the compressed air line to the pump should be disconnected and all air pressure allowed to bleed from pump. Disconnect all intake, discharge, and air lines. Drain the pump by turning it upside down and allowing any fluid to flow into a suitable container.

The Wilden single-piece manifold pump models are air-operated, double-diaphragm pumps with all wetted parts molded in PTFE PFA. The single-piece center section, consisting of center block and air chambers, is molded from glass-filled acetal on conductive models. All fasteners and hardware are stainless steel. The primary diaphragm is constructed of PTFE. All wetted sealing o-rings are PTFE encapsulated FKM on the UPII. The standard air distribution system is used on the UPII. All o-rings used in the pump are of a special material, and should only be replaced with Wilden factory-supplied parts.



NOTE: Replace worn parts with genuine Wilden parts for reliable performance.

PLEASE read all directions before starting disassembly.

DISASSEMBLY:

Before actual disassembly is started, turn pump upside down and drain all liquid trapped in the pump into a suitable container. Be sure to use proper caution if liquid is corrosive or toxic. Mark each liquid chamber to its respective air chamber for easy alignment during reassembly.

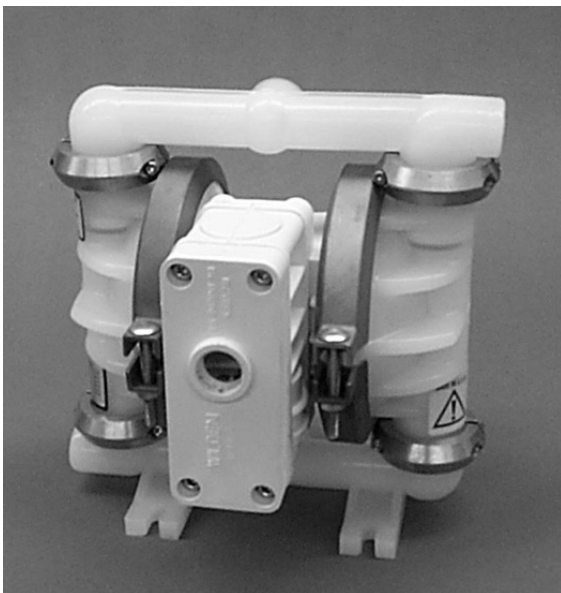

P1 PTFE PFA Construction

Disassembly / Reassembly

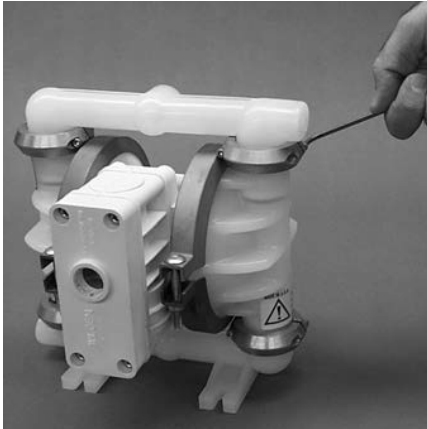

Step 1

Using an appropriate sized Allen wrench, remove clamp bands that hold the discharge manifold to the water chambers.

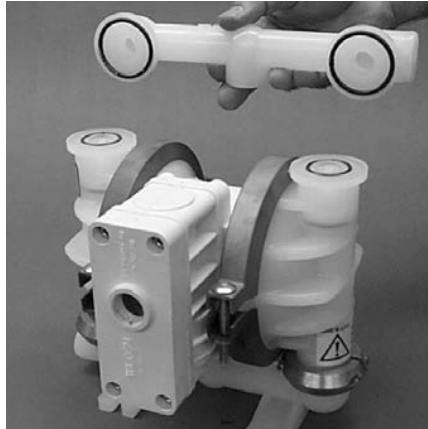

Step 2

Remove discharge manifold. It is now possible to inspect the outboard o-rings.



Step 3

Remove the o-ring, ball cage and ball valve from the water chamber. It is now possible to inspect these parts. Using the o-ring pick, remove the seat and seat o-ring from the water chamber for further inspection. If swelling, cracking or other damage is apparent, these parts must be replaced.

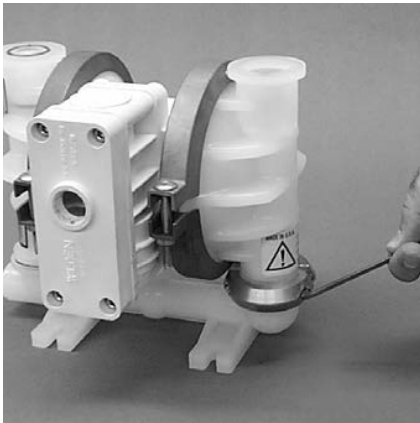

Step 4

Loosen and remove clamp bands from around the inlet manifold.

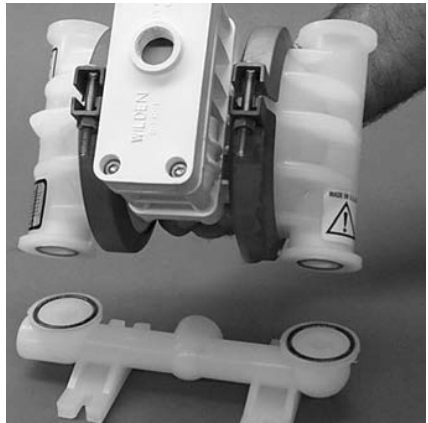

Step 5

Lift center section off of the inlet manifold. It is now possible to inspect the outboard o-rings on the inlet manifold.

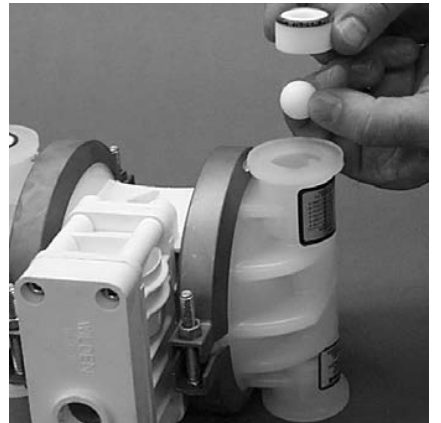

Step 6

Place center section upside-down on a flat surface. Remove the o-ring, seat and valve ball from the bottom of the water chamber. It is now possible to inspect these parts. If swelling, cracking or other damage is apparent these parts must be replaced.

Disassembly / Reassembly

Air Valve / Center Section Disassembly

Tools Required:

- 3/16" Hex Head Wrench
- 7/32" Hex Head Wrench
- Snap Ring Pliers
- O-Ring Pick



CAUTION: Before any maintenance or repair is attempted, the compressed air line to the pump should be disconnected and all air pressure allowed to bleed from the pump. Disconnect all intake, discharge, and air lines. Drain the pump by turning it upside down and allowing any fluid to flow into a suitable container. Be aware of hazardous effects of contact with your process fluid.

The Wilden Plastic P1 utilizes a revolutionary Pro-Flo® air distribution system. A 13 mm (1/2") air inlet connects the air supply to the center section. Proprietary composite seals reduce the coefficient of friction and allow the P1 to run lube-free. Constructed of acetal or polypropylene, the Pro-Flo® air distribution system is designed to perform in on/off, non-freezing, non-stalling, tough duty applications.



NOTE: Replace worn parts with genuine Wilden parts for reliable performance.

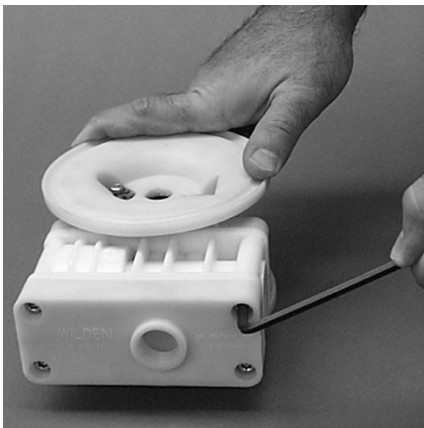

Step 1

Loosen the air valve bolts utilizing a 3/16" hex head wrench.



Step 2

Remove muffer plate and air valve bolts from air valve assembly exposing muffer gasket for inspection. Replace if necessary.



Step 3

Lift away air valve assembly and remove air valve gasket for inspection. Replace if necessary.

Disassembly / Reassembly



Step 4

Remove air valve end cap to expose air valve spool by simply lifting up on end cap once air valve bolts are removed.



Step 5

Remove air valve spool from air valve body by threading one air valve bolt into the end of the spool and gently sliding the spool out of the air valve body. Inspect seals for signs of wear and replace entire assembly if necessary. Use caution when handling air valve spool to prevent damaging seals.



NOTE: Seals should not be removed from assembly. Seals are not sold separately.



Step 6

Remove pilot spool sleeve retaining snap ring on both sides of center section with snap ring pliers.

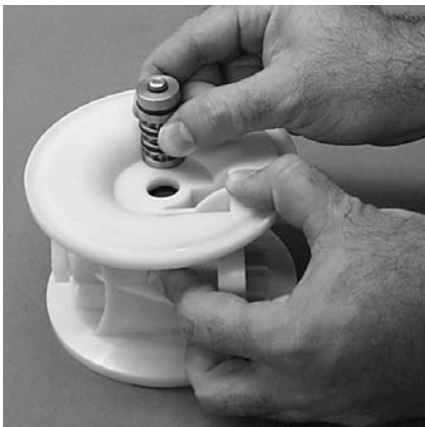

Step 7

Remove pilot spool sleeve from center section.



Step 8

With o-ring pick, gently remove the o-ring from the opposite side of the "center hole" cut on the spool. Gently remove the pilot spool from sleeve and inspect for nicks or gouges and other signs of wear. Replace pilot sleeve assembly or outer sleeve o-rings if necessary. During re-assembly never insert the pilot spool into the sleeve with the "center cut" side first, this end incorporates the urethane o-ring and will be damaged as it slides over the ports cut in the sleeve.



NOTE: Seals should not be removed from pilot spool. Seals are not sold separately.



Step 9

Check center section Glyd™ rings for signs of wear. If necessary, remove Glyd™ rings with o-ring pick and replace.

Disassembly / Reassembly

Reassembly Hints & Tips

Upon performing applicable maintenance to the air distribution system, the pump can now be reassembled. Please refer to the disassembly instructions for photos and parts placement. To reassemble the pump, follow the disassembly instructions in reverse order. The air distribution system needs to be assembled first, then the diaphragms and finally the wetted path. Please find the applicable torque specifications on this page.

The following tips will assist in the assembly process.

- Clean the inside of the center section shaft bore to ensure no damage is done to new seals.
- Stainless bolts should be lubed to reduce the possibility of seizing during tightening.
- Level the water chamber side of the intake/discharge manifold to ensure a proper sealing surface. This is most easily accomplished by placing them on a flat surface prior to tightening their clamp bands to the desired torque (see this page for torque specs).
- Be sure to tighten outer pistons simultaneously on PTFE- fitted pumps to ensure proper torque values.
- Ensure proper mating of liquid chambers to manifolds prior to tightening vertical bolts. Overhang should be equal on both sides.
- Apply a small amount of Loctite 242 to the shaft interval threads before the diaphragm assembly.
- Concave side of disc spring in diaphragm assembly faces **toward** shaft.

PRO-FLO MAXIMUM TORQUE SPECIFICATIONS

Description of Part	Torque
Air Valve, Pro-Flo [®]	3.1 N•m (27 in-lbs)
Outer Piston	14.1 N•m (125 in-lbs)
Small Clamp Band	1.7 N•m (15 in-lbs)
Large Clamp Band (Rubber-Fitted)	7.3 N•m (65 in-lbs)
Large Clamp Band (PTFE-Fitted)	9.6 N•m (85 in-lbs)
Vertical Bolts (Rubber Fitted) PVDF	5.6 N•m (50 in-lbs)
Vertical Bolts (PTFE Fitted) PVDF, PFA	2.8 N•m (25 in-lbs)
Vertical Bolts, all Polypropylene	9.0 N•m (80 in-lbs)

Gasket Kit / Installation

P1 PVDF and Ultrapure pumps come standard with expanded PTFE Gasket Kits (P/N 01-9501-99) for all sealing surfaces. P1 Poly pumps come standard with expanded PTFE Gasket Kits (P/N 01-9500-99) for diaphragm bead only.

Carefully prepare sealing surfaces by removing all debris and foreign matter from diaphragm bead and all mating surfaces. If necessary, smooth or deburr all sealing surfaces. Mating surfaces must be properly aligned in order to ensure positive sealing characteristics.

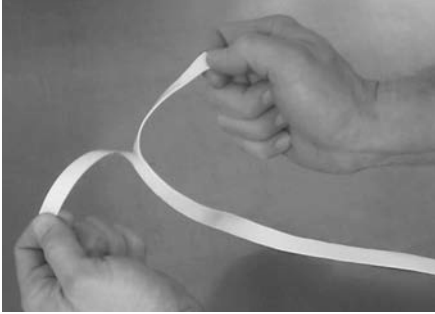

Step 1

Gently remove the adhesive covering from the back of the PTFE tape. Ensure that the adhesive strip remains attached to the PTFE tape and is not removed with the adhesive covering.



Step 2

Starting at any point, place the PTFE tape directly on top of the diaphragm bead. Press lightly on the tape to ensure that the adhesive holds it in place during assembly. Do not stretch the tape during placement on the diaphragm bead.



Step 3

The end of the tape should overlap approximately 13 mm (1/2"). Proceed to install the PTFE tape on the remaining diaphragm.

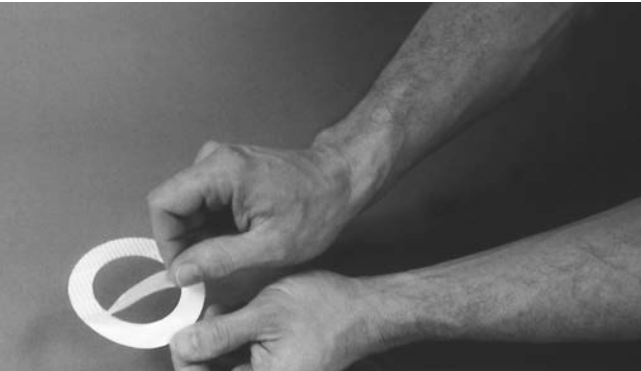

Step 4

Carefully remove the protective covering from the back of the PTFE gasket attached to tape.



Step 5

Install the valve ball, valve seat and o-ring.



Step 6

Center the gasket so that it evenly covers the o-ring and seat areas.



Step 7

Gently apply pressure to gasket to ensure the adhesive maintains a positive seal to stay in place during pump assembly.

Section 8

Exploded View and Parts Listing

P1 PLASTIC

RUBBER-FITTED

EXPLODED VIEW

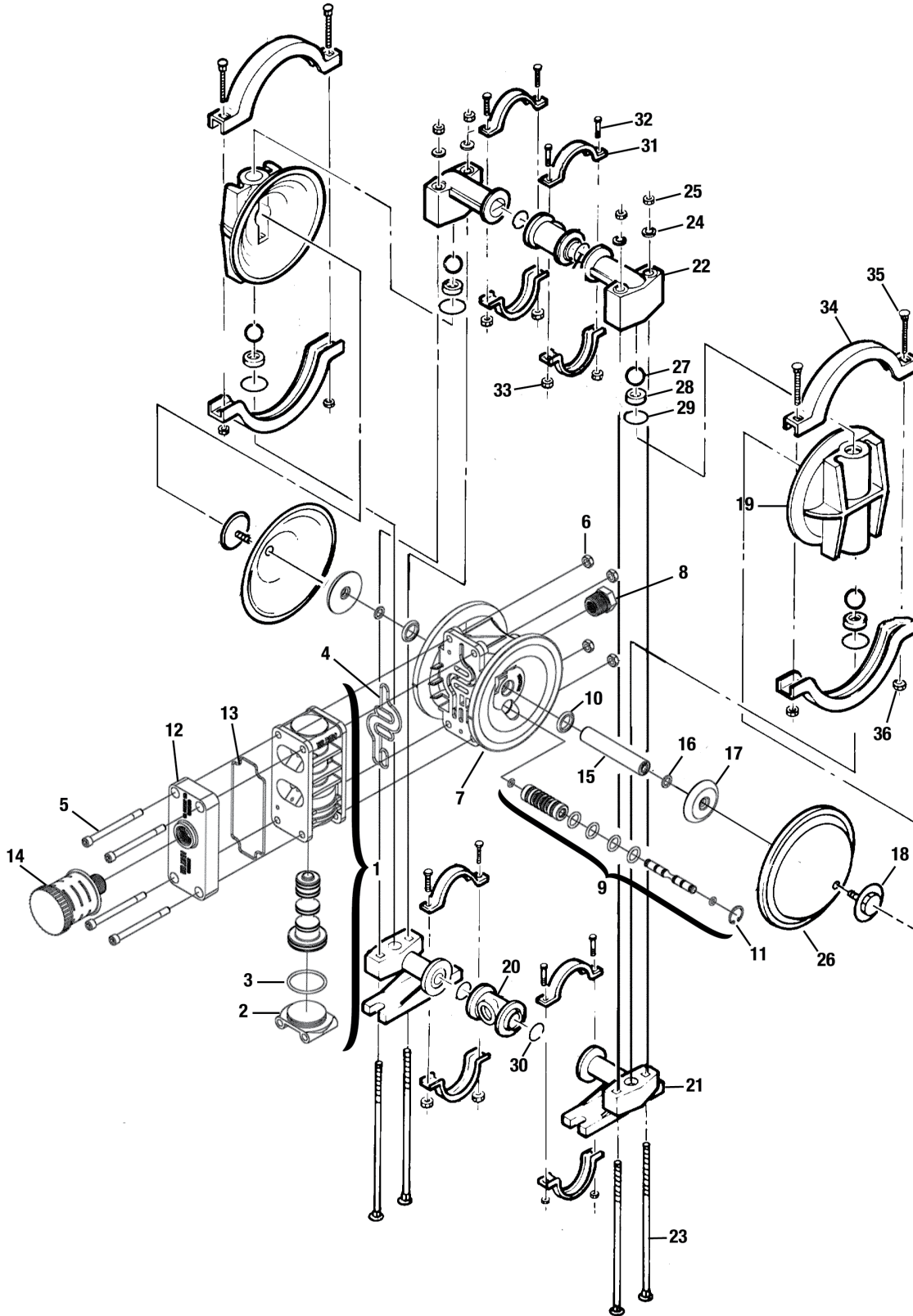

Exploded View and Parts List

Item	Part Description	Qty. Per Pump	P1/ P/PPPP P/N	P1/ K/PPPP P/N
1	Pro-Flo® Air Valve Assembly ¹	1	01-2010-20	01-2010-20
2	End Cap	1	01-2332-20	01-2332-20
3	O-Ring, End Cap	1	01-2395-52	01-2395-52
4	Gasket, Air Valve	1	01-2615-52	01-2615-52
5	Screw, HSHC, Air Valve 1/4"-20	4	01-6001-03	01-6001-03
6	Nut, Hex, 1/2"-20	4	04-6400-03	04-6400-03
7	Center Section Assembly	1	01-3140-20	01-3140-20
8	Bushing, Reducer	1	01-6950-20	01-6950-20
9	Removable Pilot Sleeve Assembly	1	01-3880-99	01-3880-99
10	Glyd™ Ring II	2	01-3220-55	01-3220-55
11	Retaining Ring	1	00-2650-03	00-2650-03
12	Muffler Plate	1	01-3181-20	01-3181-20
13	Gasket, Muffler Plate	1	01-3505-52	01-3505-52
14	Muffler	1	02-3510-99	02-3510-99
15	Shaft, Pro-Flo®	1	01-3810-03	01-3810-03
16	Disc Spring	2	01-6802-08	01-6802-08
17	Inner Piston	2	01-3711-08	01-3711-08
18	Outer Piston	2	01-4570-20-500	01-4570-20-500
19	Liquid Chamber	2	01-5000-20	01-5000-21
20	Manifold Tee Section	2	01-5160-20	01-5160-21
21	Inlet Manifold Elbow	2	01-5220-20	01-5220-21
22	Discharge Manifold Elbow	2	01-5230-20	01-5230-21
23	Screw, SHCS (Chamber Bolt)	4	01-6080-03	01-6080-03
24	Vertical Bolt Washer	4	01-6730-03	01-6730-03
25	Vertical Bolt Nut	4	04-6400-03	04-6400-03
26	Diaphragm	2	*	*
27	Valve Ball	4	*	*
28	Valve Seat	4	01-1120-21-500	01-1120-21-500
29	Valve Seat O-Ring	8	*	*
30	Manifold O-Ring	4	*	*
31	Small Clamp Band	8	01-7100-03S	01-7100-03S
32	Small Clamp Band Bolt	8	01-6101-03	01-6101-03
33	Small Clamp Band Nut	8	01-6400-03	01-6400-03
34	Large Clamp Band	4	01-7300-03S	01-7300-03S
35	Large Clamp Band Bolt	4	01-6070-03	01-6070-03
36	Large Clamp Band Nut	4	04-6400-03	04-6400-03
37	Gasket Tape & Donuts			

¹Air Valve Assembly includes items 2 and 3.

*Refer to corresponding elastomer chart in Section 10.

All boldface items are primary wear parts.

Exploded View and Parts Listing

P1 PLASTIC

PTFE - FITTED

EXPLODED VIEW

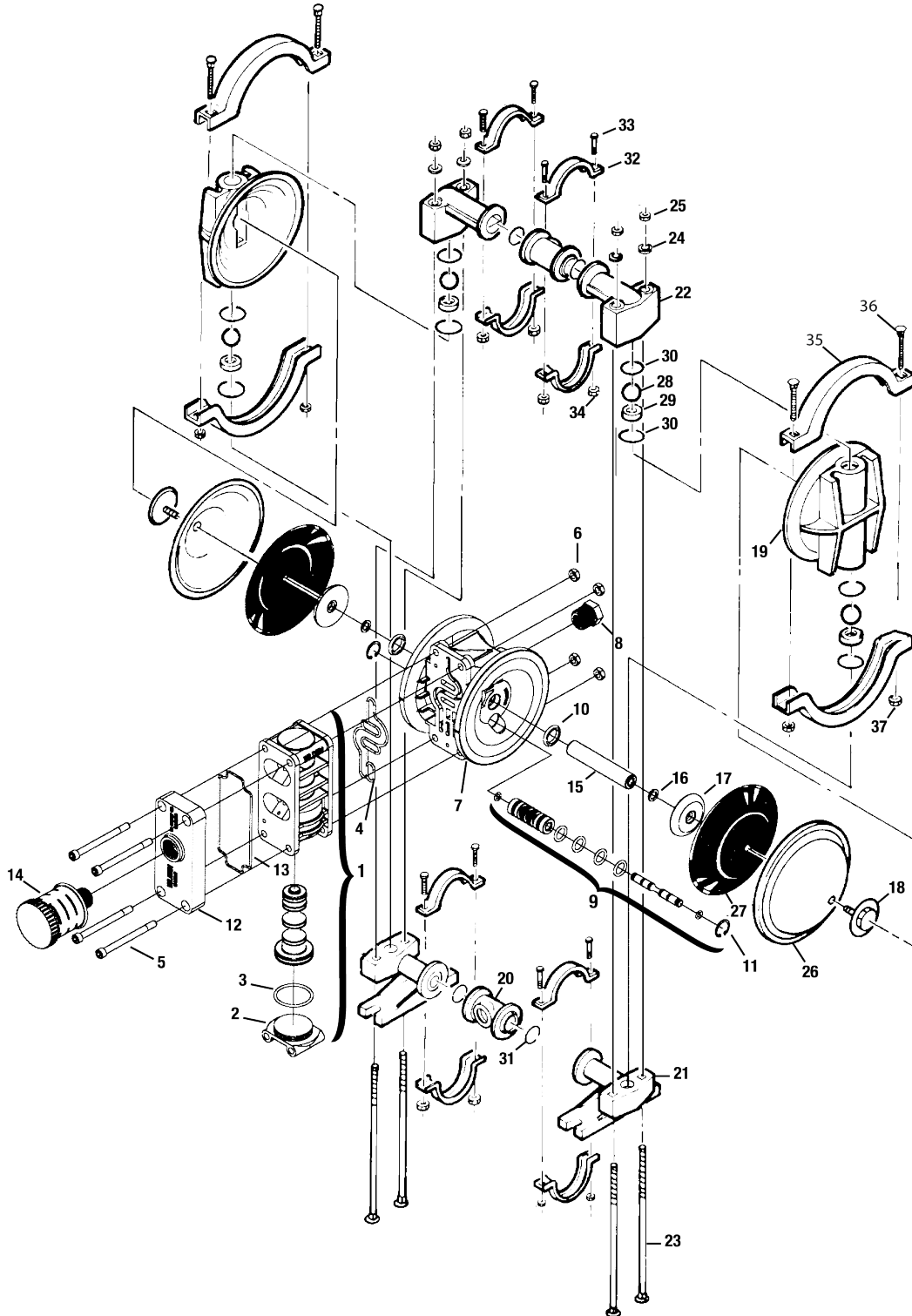

Exploded View and Parts List

Item	Part Description	Qty. Per Pump	P1/ P11111 P/N	P1/ P11111/0502 P/N	P1/ K11111 P/N	P1/ K11111/0502 P/N
1	Pro-Flo® Air Valve Assembly¹	1	01-2010-20	01-2010-20	01-2010-20	01-2010-20
2	End Cap	1	01-2332-20	01-2332-20	01-2332-20	01-2332-20
3	O-Ring, End Cap	1	01-2395-52	01-2395-52	01-2395-52	01-2395-52
4	Gasket, Air Valve	1	01-2615-52	01-2615-52	01-2615-52	01-2615-52
5	Screw, HSHC, Air Valve 1/4"-20	4	01-6001-03	01-6001-05	01-6001-03	01-6001-05
6	Nut, Hex, 1/4"-20	4	04-6400-03	04-6400-05	04-6400-03	04-6400-05
7	Center Section Assembly	1	01-3140-20	01-3140-20	01-3140-20	01-3140-20
8	Bushing, Reducer	1	01-6950-20	01-6950-20	01-6950-20	01-6950-20
9	Removable Pilot Sleeve Assembly	1	01-3880-99	01-3880-99	01-3880-99	01-3880-99
10	Glyd™ Ring II	2	01-3220-55	01-3220-55	01-3220-55	01-3220-55
11	Retaining Ring	1	00-2650-03	00-2650-03	00-2650-03	00-2650-03
12	Muffler Plate	1	01-3181-20	01-3181-20	01-3181-20	01-3181-20
13	Gasket, Muffler Plate	1	01-3505-52	01-3505-52	01-3505-52	01-3505-52
14	Muffler	1	02-3510-99	02-3510-99	02-3510-99	02-3510-99
15	Shaft, Pro-Flo®	1	01-3810-03	01-3810-03	01-3810-03	01-3810-03
16	Disc Spring (Belleville Washer)	2	01-6802-08	01-6802-08	01-6802-08	01-6802-08
17	Inner Piston	2	01-3711-08	01-3711-08	01-3711-08	01-3711-08
18	Outer Piston	2	01-4570-20-500	01-4570-20-500	01-4570-21-500	01-4570-21-500
19	Liquid Chamber	2	01-5000-20	01-5000-20	01-5000-21	01-5000-21
20	Manifold Tee Section	2	01-5160-20	01-5160-20	01-5160-21	01-5160-21
21	Inlet Manifold Elbow	2	01-5220-20	01-5220-20	01-5220-21	01-5220-21
22	Discharge Manifold Elbow	2	01-5230-20	01-5230-20	01-5230-21	01-5230-21
23	Screw, SHCS (Chamber Bolt)	4	01-6080-03	01-6080-05	01-6080-03	01-6080-05
24	Vertical Bolt Washer	4	01-6730-03	01-6730-05	01-6730-03	01-6730-05
25	Vertical Bolt Nut	4	04-6400-03	04-6400-05	04-6400-03	04-6400-05
26	PTFE Primary Diaphragm	2	01-1010-55	01-1010-55	01-1010-55	01-1010-55
27	Neoprene Backup Diaphragm	2	01-1060-51	01-1060-51	01-1060-51	01-1060-51
28	Valve Ball	4	01-1080-55	01-1080-55	01-1080-55	01-1080-55
29	Valve Seat	4	01-1120-21-500	01-1120-21-500	01-1120-21-500	01-1120-21-500
30	Valve Seat O-Ring	8	01-1205-60	01-1205-60	01-1205-60	01-1205-60
31	Manifold O-Ring	4	01-1300-60-500	01-1300-60-500	01-1300-60-500	01-1300-60-500
32	Small Clamp Band	8	01-7100-03S	01-7100-05S	01-7100-03S	01-7100-05S
33	Small Clamp Band Bolt	8	01-6101-03	01-6101-05	01-6101-03	01-6101-05
34	Small Clamp Band Nut	8	01-6400-03	01-6400-05	01-6400-05	01-6400-05
35	Large Clamp Band	4	01-7300-03S	01-7300-05S	01-7300-03S	01-7300-05S
36	Large Clamp Band Bolt	4	01-6070-03	01-6070-05	01-6070-03	01-6070-05
37	Large Clamp Band Nut	4	04-6400-03	04-6400-05	04-6400-03	04-6400-05
38	Gasket Tape & Donuts	1	01-9500-99	01-9500-99	01-9501-99	01-9501-99

¹Air Valve Assembly includes items 2 and 3.
^{*}Refer to corresponding elastomer chart in Section 10.
0502 Specialty Code = PFA-Coated Hardware
All boldface items are primary wear parts.

Section 9

Elastomer Options

P1 Plastic

Material	Diaphragm P/N	Valve Ball P/N	Valve Seat* P/N	Valve Seat O-Ring P/N	Manifold O-Ring P/N
Polyurethane	01-1010-50	01-1080-50		01-1200-50	01-1300-50
Buna-N	01-1010-52	01-1080-52		01-1260-52	01-1300-52
FKM	01-1010-53	01-1080-53	01-1120-53		
Wil-Flex™	01-1010-58	01-1080-58		00-1260-58	00-1260-58
Saniflex™	01-1010-56	01-1080-56		01-1200-56	01-1300-56
PTFE ³	01-1010-55	01-1080-55			
PTFE with integral piston	01-1030-55				
PVDF			01-1120-21-500		
PTFE Encapsulated/ FKM				01-1205-60	01-1300-60-500

¹Must be used with part number 01-5010-21-500.

PTFE diaphragms require Neoprene back-up diaphragms (P/N 01-1060-51). P1 Ultrapure pump series require high-temp Buna-N back-up diaphragms (P/N 01-1060-61).

*Rubber valve seats do not require o-rings.

Notes

Notes

Notes

PSG
22069 Van Buren Street
Grand Terrace, CA 92313-5651 USA
P: +1 (909) 422-1730 • F: +1 (909) 783-3440
psgdover.com



Where Innovation Flows

PSG[®] reserves the right to modify the information and illustrations contained in this document without prior notice. This is a non-contractual document. 05-2018