



*FINISH THOMPSON INC.*

## **SP22 Series Self-Priming Pumps**

### **Assembly, Installation and Operation Manual**

P/N 106783 R19

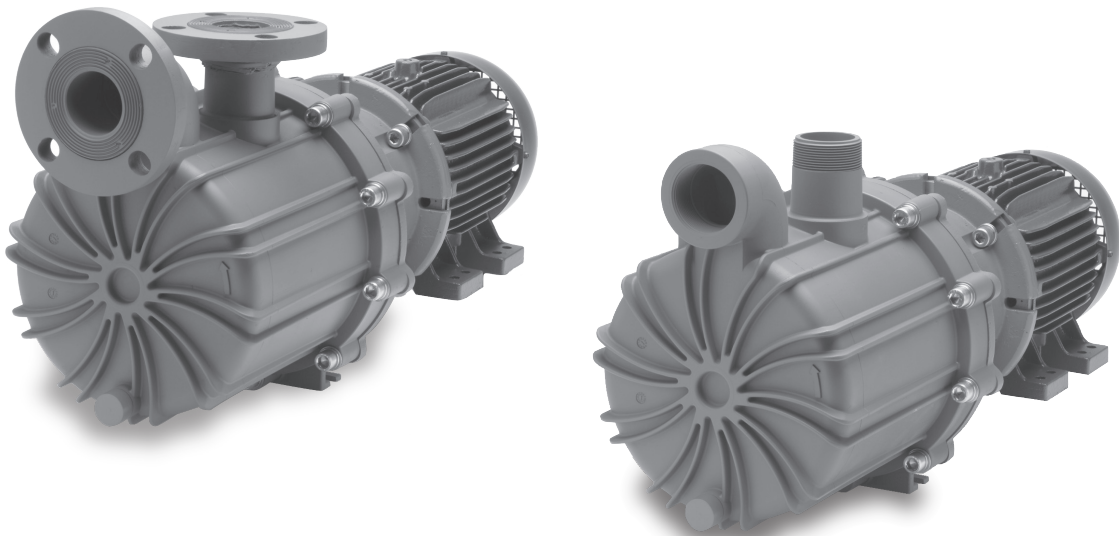



**FINISH THOMPSON INC.**

921 Greengarden Road • Erie, PA 16501-1591 U.S.A.  
 Ph 814-455-4478 • Fax 814-455-8518  
 Email [fti@finishthompson.com](mailto:fti@finishthompson.com) • [www.finishthompson.com](http://www.finishthompson.com)

**EU Declaration of Conformity**



Finish Thompson Inc. hereby declares that the following machine(s) fully comply with the applicable health and safety requirements as specified by the EU Directives listed. The product may not be taken into service until it has been established that the drive motor for the centrifugal pump complies with the provisions of all relevant EU Directives. The complete product complies with the provisions of the EC Directive on machinery safety provided motors carry CE marking.

This declaration is valid provided that the devices are fully assembled and no modifications are made to these devices.

**Type of Device:**  
 Centrifugal Pumps

**Models:**

AC/AK/AV - 400/500/600/800	GP-11/22/32	VKC-5.5/6/6H/7/8/10
DB-3/4/5/5.5/6/6H/7/8/9/10/11/15/22	MSKC	SP-10/11/15/22
KC-3/4/5/5.5/6/6H/8/10/11/22/32	MSVKC	
UC-1516/1516L/1518/1518L/2110/3158/326/326H/328/436/438/4310H/326H/4310H/6410		

**EU Directives:**

Machinery Safety (2006/42/EC)

**Applied Harmonized Standards:**

EN ISO 12100  
 EN 809

Manufacturer: Finish  
 Thompson Inc.  
 921 Greengarden Road  
 Erie, Pennsylvania 16501-1591 U.S.A

Signed,



\_\_\_\_\_  
 President

1 August 2016

Person(s) Authorized to Compile Technical File: Finish Thompson GmbH  
 Otto-Hahn-Strasse 16  
 Maintal, D-63477 DEU  
 Telephone: 49 (0)6181-90878-0

**TABLE OF CONTENTS**

Important Notice .....	3
Chemical Reaction Disclaimer .....	3
Safety Precautions .....	3
SP22 Capabilities.....	4
SP22 Prime Time Curves .....	5
Section I - Assembly	
Pumps with Motors .....	6
Pumps without Motors .....	6
Section II - Installation .....	7
Mounting.....	7
Motor/Electrical.....	8
Section III - Start-up and Operation .....	8
Section IV - Shut Down .....	8-9
Flush Systems .....	9
Maintenance .....	9
Section V - Disassembly .....	9-12
Outer Drive Replacement .....	11
Impeller Thrust Ring .....	11
Impeller Bushing .....	11
Impeller Disassembly .....	11
Reassembly .....	11-12
SP22 Part Number Explanation .....	13
Spare Parts Diagram.....	14
Spare Parts List .....	15-18
Section VI - Troubleshooting .....	19
Section VII - Warranty .....	19

**FTI Contacts:**Tech Service: 1-800-888-3743; [techservice@finishthompson.com](mailto:techservice@finishthompson.com)

Order Fax: 1-814-459-3460 or 1-814-455-8518

Sales: 1-800-934-9384 (toll free U.S. and Canada; 1-814-455-4478)

**IMPORTANT NOTICE**

U.S. Export Administration Regulations, pursuant to ECCN 2B350, prohibit the export or reexport to certain enumerated countries of sealless centrifugal pumps in which all wetted materials are constructed from fluoropolymers without first applying for and obtaining a license from the U.S. Bureau of Industry and Security (BIS). This affects all Finish Thompson magnetic-drive pumps constructed from PVDF or lined with ETFE. Please contact the BIS ([www.bis.doc.gov](http://www.bis.doc.gov)) or Finish Thompson with questions regarding the Regulations or a list of the countries to which they apply.

**Chemical Reaction Disclaimer**

The user must exercise primary responsibility in selecting the product's materials of construction, which are compatible with the fluid(s) that come(s) in contact with the product. The user may consult Finish Thompson, Inc. (manufacturer) and a manufacturer's representative/distributor agent to seek a recommendation of the product's material of construction that offers the optimum available chemical compatibility.

However neither manufacturer nor agent shall be liable for product damage or failure, injuries, or any other damage or loss arising out of a reaction, interaction or any chemical effect that occurs between the materials of the product's construction and fluids that come into contact with the product's components.

**Safety Precautions**

**⚠ WARNING:** READ THIS MANUAL COMPLETELY BEFORE INSTALLING AND OPERATING THIS UNIT. FAILURE TO FOLLOW THESE PRECAUTIONS CAN RESULT IN SERIOUS INJURY OR DEATH.

**⚠ WARNING: Magnetic field hazard.** This pump contains powerful magnets. Exposed magnets (pump not connected to motor produce powerful magnetic fields. Individuals with cardiac pacemakers, implanted defibrillators, other electronic medical devices, metallic prosthetic heart valves, internal wound clips (from surgery), metallic prosthetic devices or sickle cell anemia must not handle or be in the proximity of the magnets contained inside the pump. Consult a health care provider for specific recommendations before working with this pump.

**⚠ WARNING: The SP Series are not recommended for pumping flammable or combustible liquids (unless pump is manufactured with ATEX construction and installed in compliance with all applicable ATEX standards).** During the priming process, the pump atmosphere can become very dangerous should the pump fail to prime and overheat.

SP Series pumps can be used to pump non-flammable or non-combustible liquids in a hazardous area. However, it is important to follow these guidelines:

1. You must select the non-sparking (Ns) bronze bump ring option. The non-sparking ring is pressed into the clamp ring or motor adapter and prevents sparking should the motor bearings fail and the outer mag drive assembly runs out of round.
2. You must select an FTI explosion-proof motor or provide your own explosion-proof motor.
3. Contact Finish Thompson for more information about using pump in ATEX areas.

**⚠ WARNING: Magnetic force hazard.** This pump should only be disassembled and assembled using the recommended procedures. The magnetic attraction is powerful enough to rapidly pull the motor end and the wet end together. Do not place fingers between the mating surfaces of the motor and wet ends to avoid injuries. Keep the drive magnet and impeller assembly away from metal chips or particles, items with magnetic stripes like credit cards and magnetic computer media such as floppy discs and hard drives.

**⚠ WARNING: Hot surfaces.** This pump is capable of handling liquids with temperatures as high as 220° F (104° C). This may cause the outer areas of the pump to become hot as well and could cause burns.

**⚠ WARNING: Rotating Parts.** This pump has components that rotate while in operation. Follow local safety standards for locking out the motor from the power supply during maintenance or service.

**⚠ WARNING: Chemical Hazard.** This pump is used for transferring many types of potentially dangerous chemicals. Always wear protective clothing, eye protection and follow standard safety procedures when handling corrosive or personally harmful materials. Proper procedures should be followed for draining and decontaminating the pump before disassembly and inspection of the pump. There may be small quantities of chemicals present during inspection.

**⚠ WARNING:** Never run pump at less than minimum flow or with the discharge valve closed. This could lead to pump failure.

**⚠ WARNING:** The pump and associated components are heavy. Failure to properly support the pump during lifting and movement could result in serious injury or damage to the pump and components.

**⚠ CAUTION:** This pump should never be started without the 2 1/2 gallons (9.5 liters) of priming fluid in the housing. If the pump has a PTFE, ceramic or silicon carbide bushing, IT CANNOT BE RUN DRY WITHOUT CAUSING DAMAGE TO THE PUMP. However, the pump can operate without liquid in the housing if the pump has a carbon bushing. The exact length of time the pump can operate dry with a carbon

bushing varies with operating conditions and environment.

**CAUTION:** Never start or operate with a closed suction valve.

**WARNING:** Operation without priming or against a closed discharge valve can result in high temperatures that can result in injury or damage to pump components.

**CAUTION:** Always provide adequate NPSHa (net positive suction head available). It is recommended to provide at least 2 feet (61 cm) above the NPSHr (net positive suction head required).

**CAUTION:** If pump is used on variable speed drive, do not exceed the frequency for which the pump was designed (for example, if the pump is a 50 Hz model, do not exceed 50 Hz).

**SP22 Capabilities**

- **Maximum Working Pressure:** 90 psi (6.2 bar)
- **Maximum Temperature:** Polypropylene -180° F (82° C); PVDF – 220° F (104° C)  
**NOTE:** Maximum temperature is application dependent. Consult a chemical resistance guide or the chemical manufacturer for chemical compatibility and temperature limits.
- **Maximum Lift:** 25 feet (7.6 meters)  
**NOTE:** Lift determined on fresh, cold water with 3” Schedule 40 pipe. Specific gravity affects lift capability. Divide 25 feet (7.6 meters) by the specific gravity to determine equivalent maximum lift.
- **Solids:** Maximum particle size is 100 microns for slurries and 1/64” (.4 mm) for occasional solids. Maximum hardness is 80 HS. Maximum concentration is 10% by weight. **If solids are being pumped, it is recommended that the pump have silicon carbide components for best results.** Pumping solids may lead to increased wear.  
**NOTE:** While the pump is capable of being used in sump applications, it is NOT a trash pump. Care must be taken to ensure that debris and foreign objects do not enter the pump or damage may result. FTI recommends using a 2” (50.8 mm) or 3” (76.2 mm) strainer basket with 1/8” (3.2 mm) perforations. Regular strainer basket maintenance is required to prevent plugging and a decrease in NPSHa so not to starve and damage the pump.

• **Minimum Allowable Flow Rate**

Do not allow the flow rate to drop below the minimum flow rate in the chart below:

<b>3450/2900 rpm</b>	<b>1750/1450 rpm</b>
10 US gpm (2.3 m <sup>3</sup> /hr)	5 US gpm (1.1 m <sup>3</sup> /hr)

• **Maximum Allowable Motor Power**

Do not exceed 7.5 kW (10 horsepower) for 50 Hz, 2900 rpm applications. For 60 Hz, 3450 rpm applications, the pump is capable of starting a 15 horsepower motor but is limited to a maximum of 13 horsepower (9.7 kW) while running. Use the information in the chart below to determine the maximum specific gravity capabilities by impeller trim for non-overloading applications. The use of a power monitor is strongly recommended for 60 Hz applications above 10 horsepower (7.5 kW).

• **Maximum Noise Level:** 80 dBA (pump only)

• **Maximum Specific Gravity for Non-Overloading Applications**

3450 rpm (60 Hz)		2900 rpm (50 Hz)	
Impeller Diameter	Maximum Specific Gravity	Impeller Diameter	Maximum Specific Gravity
7” (177.8 mm)	1.0	177.8 mm (7”)	1.35
6.5” (165.1 mm)	1.3	165.1 mm (6.5”)	1.65
6” (152.4 mm)	1.6	152.4 mm (6”)	1.8
5.5” (139.7 mm)	1.8	139.7 mm (5.5”)	1.8
5” (127.0 mm)	1.8	127.0 mm (5”)	1.8

- **Priming Liquid Volume**

Initial filling (or refilling after maintenance) of the pump housing requires (2 1/2) US gallons (9.5 liters) of liquid.

- **Priming Time**

Priming time varies with the impeller diameter and speed.

### SP22 Priming Time

3450 RPM - 2" Suction Pipe

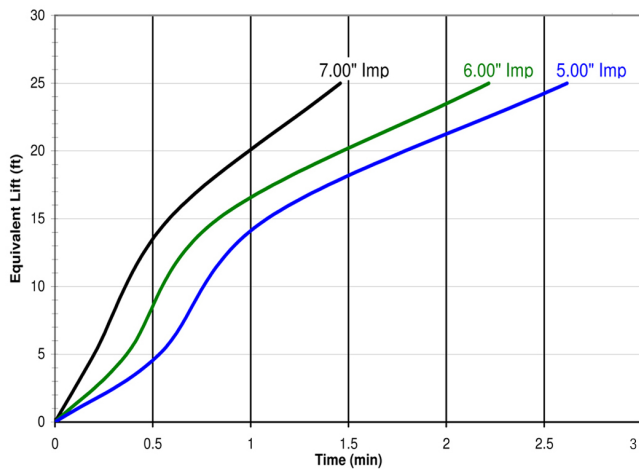

2900 RPM - 2" Suction Pipe

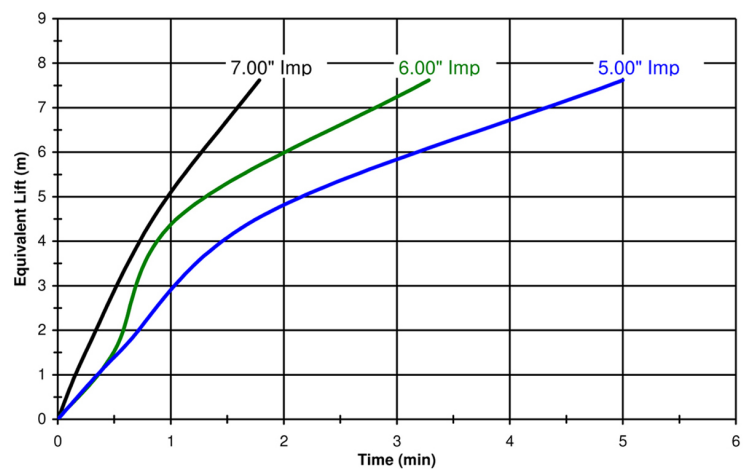

3450 RPM - 3" Suction Pipe

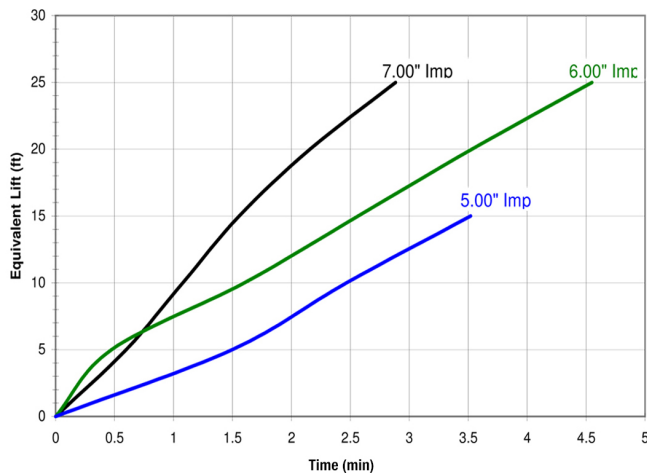

2900 RPM - 3" Suction Pipe

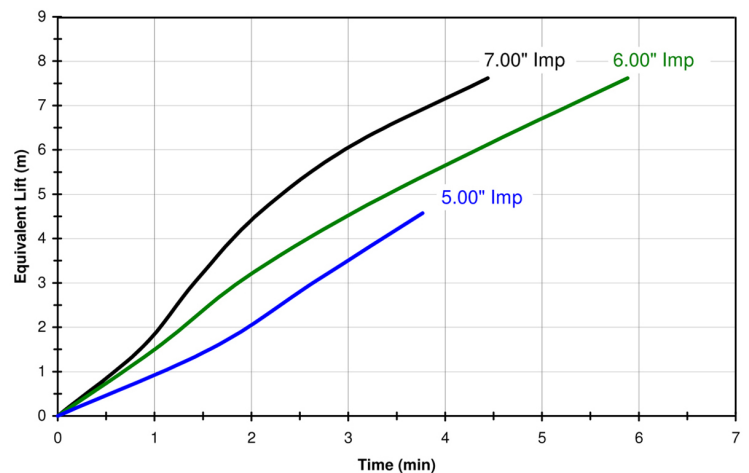

Note: Times shown are guidelines only and may vary depending on system and piping setup  
 Recommend using 2" suction pipe with impellers less than 5.50" at equivalent lifts greater than 15' (4.6 m)



## SP22 Assembly, Installation and Operation

### Unpacking and Inspection

Unpack the pump and examine for any signs of shipping damage. If damage is detected, save the packaging and notify the carrier immediately.

### Section I - Assembly

#### Tools Required:

3/8" Allen wrench or ballpoint hex socket, 3/16" Allen bit & torque wrench, 10 mm hex socket, metric socket set (for pumps with IEC outer drives)

#### Pumps with Motors

Proceed to "Installation" Section

#### Pumps Without Motors

NOTE: All motors must have motor feet.

1. Remove the pump, drive magnet assembly and hardware package from the carton.

**CAUTION:** Keep away from metallic particles, tools and electronics. Drive magnets **MUST** be free of metal chips.

**WARNING:** Keep the drive magnet away from the open end of the motor adapter and barrier. Strong magnetic attraction could allow the drive hub to enter the motor adapter resulting in injury or damage.

2. **For 184TC motors**, proceed to step 3.

**For 213/215 NEMA motors only** – Install the o-ring (item 14A) in the groove in the motor adapter. Use small amount of petroleum jelly (or silicone grease on EPDM o-rings) to help hold the o-ring in place. Install the larger female rabet portion of the motor adapter flange (item 14) on the motor face. Align the holes in the adapter with the holes in the motor face. See figure 1.



Figure 1

**For IEC 90, 100/112, 132 with B5 flange motors** - Install flange (item 14) on motor with pockets (depressions) side towards the motor face. Align (4) holes in the adapter with the holes in the motor face. install the (4) bolts, lock washers and flat washers through the motor adapter into the motor face. See figure 1.

**Note:** B5 flange motors require customer supplied hardware.

Flange hole thread size:  
 90 B5 = M10 x 1.5  
 100/112 B5 = M12 x 1.75  
 132 B5 = M12 x 1.75

**For 90 & 132 with B14 flange & 145TC motors** - Install the flange item 14) on motor with pockets (depressions) side

towards the motor face. Align (4) holes in the adapter with the holes in the motor face. Install (4) bolts, lock washers and flat washers (items 24, 25, 26) through the motor adapter into the motor face. See figure 1.

#### For 100/112 with B14 flange motors

Install flange (item 10) on motor with pockets (depressions) towards the pump motor adapter (item 8). Align (4) holes in the adapter with the holes in the motor face. Install (4) bolts, lock washers and flat washers (items 20, 21, 22) through the motor adapter into the motor face.

#### Torque bolts to the following:

90/100/112 B14 frame (M8) = 130 in-lb (14.7 N-m)  
 132 B14 (M10) frame (M10) = 240 in-lb (27.1 N-m)  
 90 frame B5 (M10) = 240 in-lb (27.1 N-m)  
 100/112/132 B5 (M12) = 480 in-lb (54.3 N-m)

3. Coat the motor shaft with anti-seize compound. Insert key supplied with motor into keyway on motor shaft.

**NOTE:** Make sure the motor shaft is clean and free of burrs. The outer drive is precision machined and has a bore tolerance of +.0005/-0 inch.

4. Slide the outer drive magnet assembly (item 13) onto the motor shaft until the motor shaft contacts the snap ring in the bore of the drive. Figures 2 and 3.

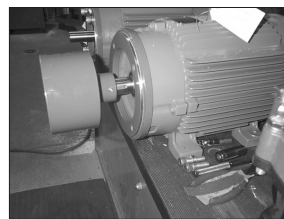

Figure 2



Figure 3

**WARNING:** Be careful, magnets will try to attract tools.

**Metric Motors:** Secure the drive to the motor shaft using bolt, lock washer and flat washer (items 21, 22, 23). Thread the bolt into the end of the motor shaft (while holding the outer drive to prevent it from turning). See figure 4.

Tighten the bolt to the following:

· 90 frame (M8) = 130 in-lb (14.7 N-m)  
 · 100/112 frame (M10) = 240 in-lb (27.1 N-m)  
 · 132 frame (M12) = 480 in-lb (54.3 N-m)

**NEMA Motors:** Install set screws (item 13B) into threaded holes on the side of the outer drive magnet assembly. Using a 3/16" Allen bit & torque wrench, tighten to 228 in-lbs (25.8 N-m). See figure 5.

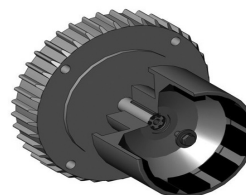

Figure 4

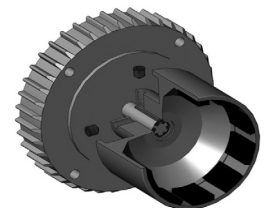

Figure 5

**NOTE:** The clearance between the motor adapter and drive magnet is tight (about .010"/.254 mm).

5. Install the pump end on the motor/drive magnet assembly.

For 182, 184, 213 and 215TC motor frame pumps, install the o-ring (item 12B) in the groove in the motor adapter (motor end). Use a small amount of petroleum jelly (or silicone grease on EPDM o-rings) to help hold the o-ring in place.

Place the motor/drive on the floor with the drive and motor face pointing up.

Firmly grab the pump and slide over the outer drive magnet until the motor adapter is seated in the rabbet of the motor (184TC) or the motor adapter flange. See figures 6 and 7. The last 4-5" (10-12 cm) will have strong magnetic attraction between the pump and outer drive magnet.

6. Secure the pump to the motor using (4) 1/2" socket head



Figure 6



Figure 7

cap screws, lock washers and flat washers (items 18, 19, 20). Use 3/8" Allen wrench or 3/8" ballpoint hex socket on universal joint. See figures 8 and 9.

7. Rotate the motor fan to ensure that there is no binding in the pump.



Figure 8

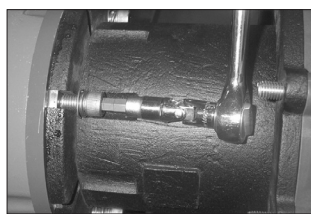

Figure 9

8. Proceed to Installation Section.

## Section II - Installation

**Mounting** – Pump foot should be securely fastened to a solid foundation. If the pump was received with plastic shipping shims, these may be used as additional support for the motor feet.

**CAUTION:** The NPSH available to the pump must be greater than the NPSH required. The amount of lift, frictional pipe loss and vapor pressure must be calculated into the application. NPSH available should be two feet (.6 meters) greater than NPSH required.

- Total suction lift including pipe friction loss and corrections for specific gravity must not exceed 25 feet (7.6 meters). Contact FTI for pumps installed where the elevation exceeds 1,000 feet (305 meters).

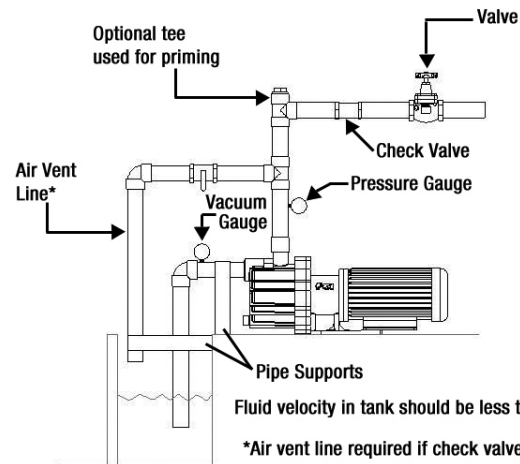

- Install the pump as close to the suction source as possible.
- SP Series pumps are designed to operate in a horizontal position only with discharge on the top.
- SP Series pumps self-priming capability is due to its ability to create a vacuum in the suction piping. **The suction piping MUST be airtight at fittings and connections.**
- Support the piping independently near the pump to eliminate any strain on the pump casing. In addition, the piping should be aligned to avoid placing stress on the pump casing.
- The suction side of the pump should be as straight and short as possible to minimize pipe friction.
- The suction line should not have any high spots. This can create air pockets that can reduce pump performance. The suction piping should be level or slope slightly upward to the pump.
- The suction pipe should be 2" or 3". Larger suction piping will affect priming ability. Smaller piping affects NPSH available and pump performance. See priming curves on page 4 or performance curves in SP Series curve booklet.
- Provide for adequate suction submergence. Excessive submergence will reduce pump performance.
- The end of the pipe should be at least 3" (7.6 cm) above the bottom of the suction tank.
- If debris is in the suction tank, a strainer can be installed to help prevent foreign matter from entering the pump. The



strainer must be periodically cleaned to prevent restriction. Strainer hole size should be 1/8" (1.6 mm) with the amount of open area equal to or greater than 2 times the suction pipe diameter.

- It is recommended that a vacuum/pressure gage be installed in the suction piping.
- For faster priming on installations with high lift, a foot valve is recommended.
- Check and control valves (if used) should be installed on the discharge line. The control valve is used for regulating flow. Isolation valves on the suction and discharge are used to make the pump accessible for maintenance. The check valve helps protect the pump against damage from water hammer. This is particularly important when the static discharge head is high.

**NOTE:** If a check valve is used in the discharge line, it must be placed at a distance at least equal to the maximum suction lift from the pump. If this cannot be done, an air vent must be provided in the discharge line.

- If flexible hose is preferred over pipe, use a reinforced hose rated for the proper temperature, pressure and is chemically resistant against the fluid being pumped.
- The suction valve must be completely open to avoid restricting the suction flow.
- When installing pumps with flanges, we recommend use of low seating stress gaskets such as Gore-Tex® or Gylon® (expanded PTFE).
- It is advisable to install a flush system in the piping to allow the pump to be flushed before the pump is removed from service.

**NOTE:** The pump is provided with a 1/2" BSPP drain in the impeller housing.

- A "tee" can be installed in the discharge piping as an alternative location for filling the housing with fluid before pump operation.
- "Filling" is defined as filling the housing with 2 1/2 gallons (9.5 liters) of liquid
- "Priming" is defined as evacuating all the air from the suction piping/pump and replacing it with fluid.

#### Motor/Electrical

Only qualified personnel trained in the safe installation and operation of this equipment should install the motor. Install the motor according to National Electric Code, NEMA MG-2, IEC standards requirements and/or applicable local electrical codes. The voltage and frequency variations of the power supply should

never exceed the limits established in the applicable standard. Prior to connecting to the power line, check nameplate voltage, rotation connection and ensure proper grounding. Sufficient ventilation area should be provided to insure proper operation and cooling of the motor. The motor must be installed with a suitable overload protection circuit. For three phase motors it is recommended to install a phase failure protection device. Download the motor manual from the specific motor manufacturers' website for additional information concerning motor installation, safety and maintenance instructions.

Wire the motor for clockwise rotation when facing the fan end of the motor.

**⚠ CAUTION:** Do not operate the pump to check rotation until the pump is full of liquid or damage may occur even if the motor is "bumped" to check motor rotation direction.

Check all electrical connections with the wiring diagram on the motor. Make sure the voltage, frequency, phase and amp draw comply with the supply circuit.

If utilized, verify that power monitors or variable frequency drives have been properly installed according to the manufacturer's instructions.

To verify correct rotation of the motor:

1. Install the pump into the system.
2. Remove the fill plug and fill the housing with (2 1/2) US gallons (9.5 liters) of the service liquid or water. Replace fill plug and tighten until the o-ring is seated.
3. Fully open the suction and discharge valves.
4. Jog the motor (allow it to run for 1-2 seconds) and observe the rotation of the motor fan. Refer to the directional arrow molded into the front of the housing if necessary.

**NOTE:** An SP pump running backwards may not prime.

#### Section III - Start-up and Operation

1. Be sure the housing has been filled with 2 1/2 gallons (9.5 liters) of service liquid and the fill plug has been installed and tightened until the o-ring is seated.
2. Open the inlet (suction) and discharge valves completely.
3. Turn the pump on. Wait for discharge pressure and flow to stabilize (could take several minutes depending upon suction lift). Adjust the flow rate and pressure by regulating the discharge valve. Do not attempt to adjust the flow with the suction valve.

#### Section IV - Shutdown

Turn off the motor.

**NOTE:** When the pump is stopped without a check valve in the piping, liquid will flow through the pump returning to the suction source. The SP design allows enough liquid to be retained in the housing to allow repriming without having to refill with liquid.

**Flush Systems**

**CAUTION:** Some fluids react with water; use compatible flushing fluid.

1. Turn off the pump.
2. Completely close the suction and discharge valves.
3. Connect flushing fluid supply to flush inlet valve.
4. Connect flushing fluid drain to flush drain valve.
5. Open flushing inlet and outlet valves. Flush system until the pump is clean.

**NOTE:** The drain can be used as the flushing drain valve using appropriate customer supplied fittings. Using the drain helps to promote superior flushing and draining results.

**Maintenance**

Recommended maintenance schedule

The recommended maintenance schedule depends upon the nature of the fluid being pumped and the specific application. If the pump is used on a clean fluid, it is recommended that the pump be removed from service and examined after six months of operation or after 2,000 hours of operation. If the pump is used on fluids with solids, high temperatures or other items that could cause accelerated wear this initial examination should be sooner.

After the initial examination of the internal components and wear items are measured, a specific maintenance schedule can be determined. For best results, it is recommended that the pump be removed from service annually for examination.

**Section V - Disassembly**

Tools Required:

3/8" Allen wrench or ballpoint hex socket, 3/16" Allen wrench, (2) flat head screw drivers, 10 mm hex socket, metric socket set (for pumps with IEC outer drives).

**WARNING:** Rotating Parts. This pump has components that rotate while in operation. Follow local safety standards for locking out the motor from the power supply during maintenance or service.

**WARNING:** Chemical Hazard. This pump is used for transferring many types of potentially dangerous chemicals. Always wear protective clothing, eye protection and follow standard safety procedures when handling corrosive or personally harmful materials. Proper procedures should be followed for draining and decontaminating the pump before disassembly and inspection of the pump. There may be small quantities of chemicals present during inspection.

**WARNING:** Magnetic force hazard. This pump should only be disassembled and assembled using the recommended procedures. The magnetic attraction is powerful enough to rapidly pull the motor end and the wet end together. Do not place fingers between the mating surfaces of the motor and wet ends to avoid injuries. Keep the drive magnet and impeller assembly away from metal chips or particles.

1. Stop the pump, lock out the motor starter, close all the valves that are connected to the pump, and drain/decontaminate the pump.

**WARNING:** The pump must be thoroughly flushed of any hazardous materials and all internal pressure relieved prior to opening the pump. Allow the pump to reach ambient temperatures prior to performing maintenance.

2. Place the pump/motor on the floor with the pump facing up. Remove (4) 1/2" socket head cap screws, lock washers and flat washers (items 18, 19, 20) securing the pump to the motor. Use 3/8" Allen wrench or 3/8" hex socket on universal joint.
3. Firmly grab the motor adapter and pull straight up to disengage the motor and pump. See figure 10.



Figure 10

**For 182, 184, 213, and 215TC motor frame pumps,** make sure the o-ring (item 12B) does not fall out of the motor adapter (motor end).

4. Place pump on bench with housing (item 1) facing up. Using a 10 mm hex (Allen) wrench, remove (10) M12 socket head cap screws, lock washers and flat washers (items 15, 16, 17). See figure 11.



Figure 11

Remove the housing (item 1) by carefully inserting two flat head screwdrivers at the locations shown in Figure 12. Slide the screwdrivers in at the bolt holes between the metal motor adapter and the housing until they stop.

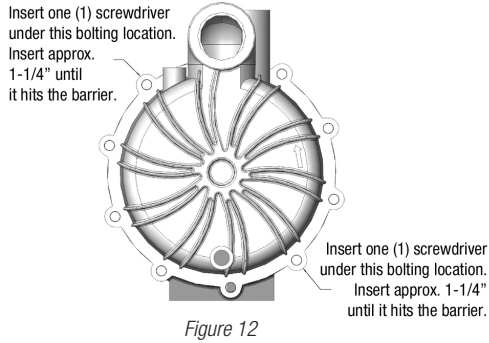

Figure 12

Applying equal pressure, gently pry both screwdrivers in upward motion away from the table (to avoid damaging sealing surface). See figure 12A. Housing is tight due to o-ring seal on the internal "gooseneck".

**NOTE:** Do not twist the screwdrivers or damage may occur to the housing.

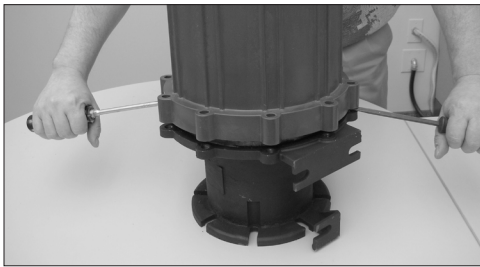

Figure 12A

5. Examine the housing for signs of wear or damage. Inspect the gooseneck and suction and discharge for cracks. See figure 13. Inspect fill and drain plug o-rings (item 2A) for chemical attack, swelling, brittleness, cuts, etc.
6. Carefully remove the inner volute o-ring (item 4). See figure 14. Inspect for chemical attack, swelling, brittleness, cuts, etc.

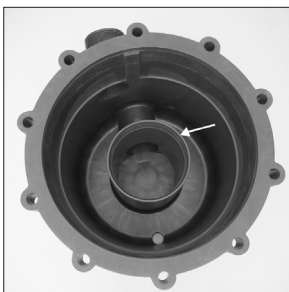

Figure 13



Figure 14

7. Pull the separator plate (item 5) off the inner volute (item 6). Inspect for damage and cracks.
8. To remove the inner volute (item 6), pull back on the (3) snap fit prongs one at a time so that the hook portion falls into the channel on the inner volute. See figures 15 and 16.

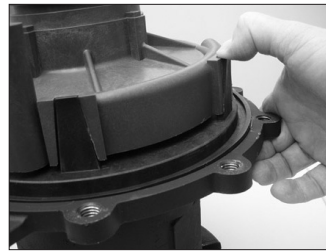

Figure 15

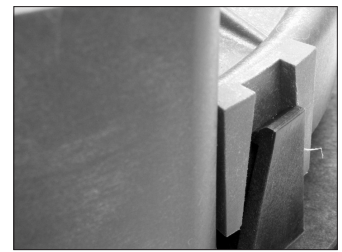

Figure 16

9. Pull the inner volute straight off. Be careful since the impeller shaft may come out with the inner volute. See figure 17.
10. Remove impeller/inner drive assembly (items 7A, 7, 8, 8A). Inspect for signs of rubbing, damage and wear. See figure 18. Check the impeller thrust ring and bushing for wear. See figure 19.

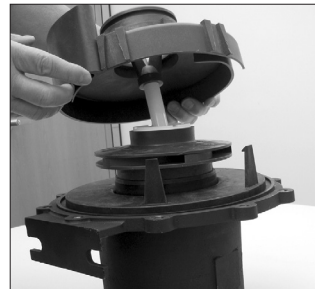

Figure 17



Figure 18

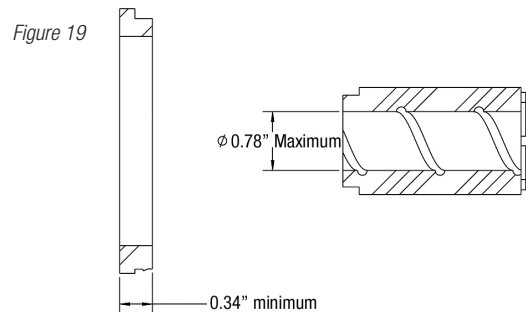

Figure 19

11. Remove the impeller shaft (item 9) from the barrier and check for signs of cracking, chipping, scoring or wear. See figure 20.
12. Remove the barrier (item 11) from the motor adapter (item 12) (make sure the impeller shaft has been removed). If necessary, gently tap on the backside of the barrier with a soft rod (wood, plastic, etc). Inspect the inside and outside of the barrier for signs of rubbing. See figure 21.



Figure 20

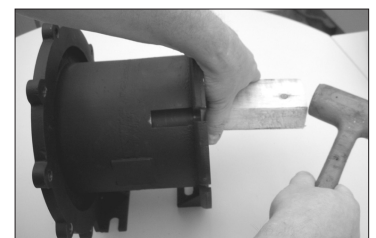

Figure 21



13. Remove the o-ring (item 10) from the barrier and inspect for chemical attack, swelling, brittleness, cuts, etc.
14. Visually inspect the outer drive (item 13) for rubbing, damage, corrosion or loose magnets.

**For 182, 184, 213 and 215TC frame pumps only**, inspect the o-rings (item 12A, 12B and 14A if applicable) for chemical attack, swelling, brittleness, cuts, etc.

### Outer Drive Replacement

1. Remove the setscrews (item 13B) from the side of the drive (NEMA motors) or the bolt, lock washer and flat washer (items 21, 22, 23) from the center of the drive (metric motors).

**⚠ WARNING:** Be careful, tools will want to be attracted to the magnets.

2. Remove the drive magnet from the motor shaft by gently prying up from the bottom of the drive. See figure 22.

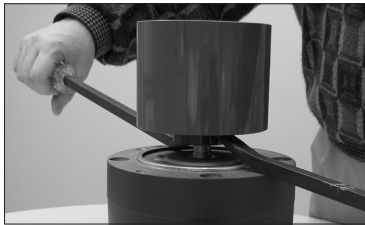

Figure 22

3. To reinstall the drive or a new drive follow the instructions from Section I – Assembly, Pumps without Motors, steps 3 & 4.

### Impeller Thrust Ring

The impeller thrust ring is located in the front of the impeller shroud and is held in place with a snap-fit ridge.

#### Removal

1. Using a razor knife or side cutters, cut a notch out of the thrust ring. Pull up and out of the holder. See figures 23 and 24.

**NOTE:** A new impeller thrust ring will be required after removal.

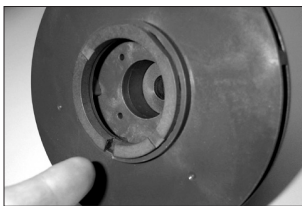

Figure 23

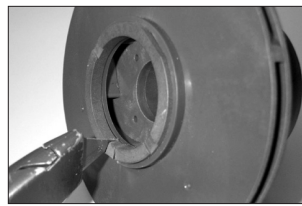

Figure 24

#### Replacement

1. Place the impeller and impeller drive assembly (items 7, 7A, 8 & 8A) on a table with the eye of the impeller facing up.
2. Position the replacement impeller thrust ring in the bore of the front shroud with the snap fit ridge towards the bottom of the bore. Align the anti-rotation flat on the impeller thrust ring with the flat in the impeller shroud.
3. Place the impeller and impeller drive assembly in an arbor

press. Using a soft faced arbor, gently press the impeller thrust ring into place.

### Impeller Bushing

#### Removal

1. To remove the bushing, place the impeller/inner drive assembly (items 7, 7A, 8 & 8A) with the impeller facing up in an arbor press. If necessary support the bottom of the assembly with blocks to allow the bushing to fall out. Insert a 1" (25.4 mm) diameter plastic or wooden shaft through the impeller and press bushing out. See figure 25.
2. To replace bushing, place the assembly on a flat surface with the impeller thrust ring face down. With the slotted face of the bushing facing the rear of the inner drive, align the flat in the bushing with the flat in the inner drive magnet. See figure 26. Gently push until bushing bottoms out.



Figure 25

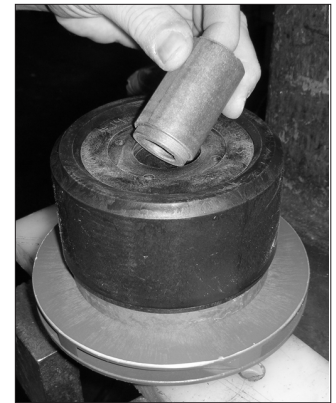

Figure 26

### Impeller Disassembly

To separate impeller (item 7A, 7) from the inner drive (item 8A, 8), use two flat head screwdrivers in slots provided to gently pry apart.

#### Reassembly

1. Install impeller shaft (item 9) into barrier (item 11) by aligning the flats on the shaft with the ones in the barrier. Make sure it is completely seated. See figure 27.
2. Carefully install the impeller/inner drive assembly (items 7A, 7, 8, 8A) by sliding it over the impeller shaft in the barrier. See figure 28.



Figure 27



Figure 28

3. Install the inner volute (item 6) by lining up the prongs of the barrier with the channels in the inner volute. Press down evenly until the prongs snap onto the surface of the inner volute. See figure 29.

**⚠ WARNING:** Magnetic force hazard. Keep fingers away from mating surfaces.

4. Install barrier, inner volute, impeller/inner drive and impeller shaft assembly into the motor adapter (item 12). Line up the center of the inner volute bottom port with the center of the motor adapter foot. See Figure 30.

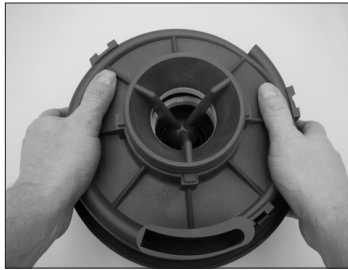

Figure 29



Figure 30

**NOTE:** If the pump has the o-ring sealing option (available on 184 and 215 frame pumps only), install the o-ring (item 12A) in the groove in the motor adapter before installing the barrier, inner volute, impeller/inner drive and impeller shaft. Barrier will have to be pushed into place with o-ring sealing option.

**NOTE:** Bolts are not on center line.

5. Install o-ring (item 10) in groove in barrier. Make sure o-ring is properly seated.
6. Install the separator plate (item 5) by lining up the bottom opening of the inner volute with the opening in the plate. Line up the slots in the separator plate with the notches in the inner volute. See figure 31.
7. Lubricate the inner volute o-ring (item 4) with a chemically



Figure 31



Figure 32

compatible lubricant and install in the groove on the round suction nozzle in the center of the inner volute. See figure 32.

8. Install the housing (item 1). Lubricate the inside of the gooseneck with a chemically compatible lubricant. See figure 33. Line up the notch on the top of the separator plate with the tab in the housing (located inside the front of the housing near the discharge port). See figure 34.

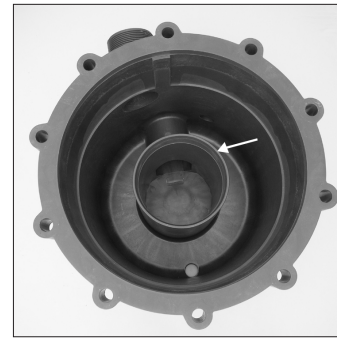

Figure 33

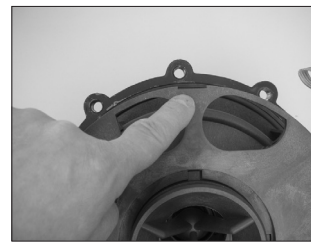

Figure 34

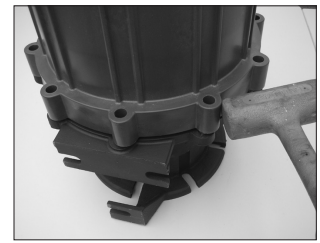

Figure 35

Using uniform pressure, press the housing into place until it is flush with the motor adapter. Rotate the housing if necessary to line up the bolt holes in the housing with the bolt holes in the motor adapter. Tap lightly with a soft mallet if necessary. See figure 35. Install the housing bolts, lock washers and flat washers (items 15, 16, 17).

9. Tighten all bolts evenly using a star pattern. Tighten to 240 in-lbs (27.1 N-m).
10. Reinstall the pump on the motor/drive magnet following instructions found in "Assembly, Pumps without motors," steps 5-8.



**SP22 PART NUMBER EXPLANATION**

**NOTE:** Pump end includes wetted components, drive magnet and motor adapter. The wet end includes wetted components only.

**Part Number Explanation**

The base model number contains standard components. Where standard components are not suitable, add the alternative component code letter after the base model number to substitute components. Example: SP22P-E-U-21 is constructed of the listed base model components except it has an EPDM O-ring, union connections, and a 213TC motor adapter.

The model number is on the serial number label located on the motor adapter. The model number contains a base model that features certain standard components. Compare the model number on the pump to the adjacent chart to determine if the pump contains any alternate components. Model numbers containing "P" have primary components molded from polypropylene. Model numbers contain "V" have primary components molded from PVDF.

**Base model numbers are: SP22P, SP22V**

Alternative Components Price Adders										
Component	Base		Alternative							Code
<b>Bushing</b>	<b>Carbon</b>	or	PTFE							T
<b>O-ring</b>	<b>Viton</b>	or	EPDM							E
<b>Connection</b>	<b>NPT</b>	or	BSP							B
			Union							U
			Steel Reinforced Flange - ANSI 150 / PN20/40 / JIS 10K							Fs
			2" x 2" FRP Flange - ANSI 150 / PN20/40 / JIS 10K							Ff
			3" x 2" FRP Flange - ANSI 150 / PN20/40 / JIS 10K							3 x 2
<b>Impeller</b>	<b>1 (60 Hz) 7"</b>	or	1A	1B	1C	2	2A	2B	2C	3
			6.88"	6.75"	6.63"	6.50"	6.38"	6.25"	6.13"	6.00"
			3A	3B	3C	4	4A	4B	4C	5
			5.88"	5.75"	5.63"	5.50"	5.38"	5.25"	5.13"	5.00"
<b>Magnet (Upgrade for specific gravity corrections)</b>	<b>8-pole Up to 13 HP (60 Hz) / 7.5 kW (50 Hz)</b>	or	No Upgrade Available.							
<b>Motor Adaptor</b>	<b>182-184TC NEMA</b>	or	145TC NEMA							145
			213-215TC NEMA							21
			IEC 90/B14							94
			IEC 100/B14							04
			IEC 112/B14							24
			IEC 132/B14							34
			IEC 90/B5							95
			IEC 100/B5							05
			IEC 112/B5							25
			IEC 132/B5							35
			Gas engine mounting							Ge
<b>Specials</b>	<b>Not Standard</b>		SiC bushing/shaft							Ss
			SiC bushing/impeller thrust ring/shaft							Si
			Hastelloy shaft							Hs
			Titanium Hardware							Ti
			Non-sparking ring							Ns
<b>Motor</b>	<b>Not Standard</b>		Contact dealer or factory for motor details							

# SP22 PARTS DIAGRAM

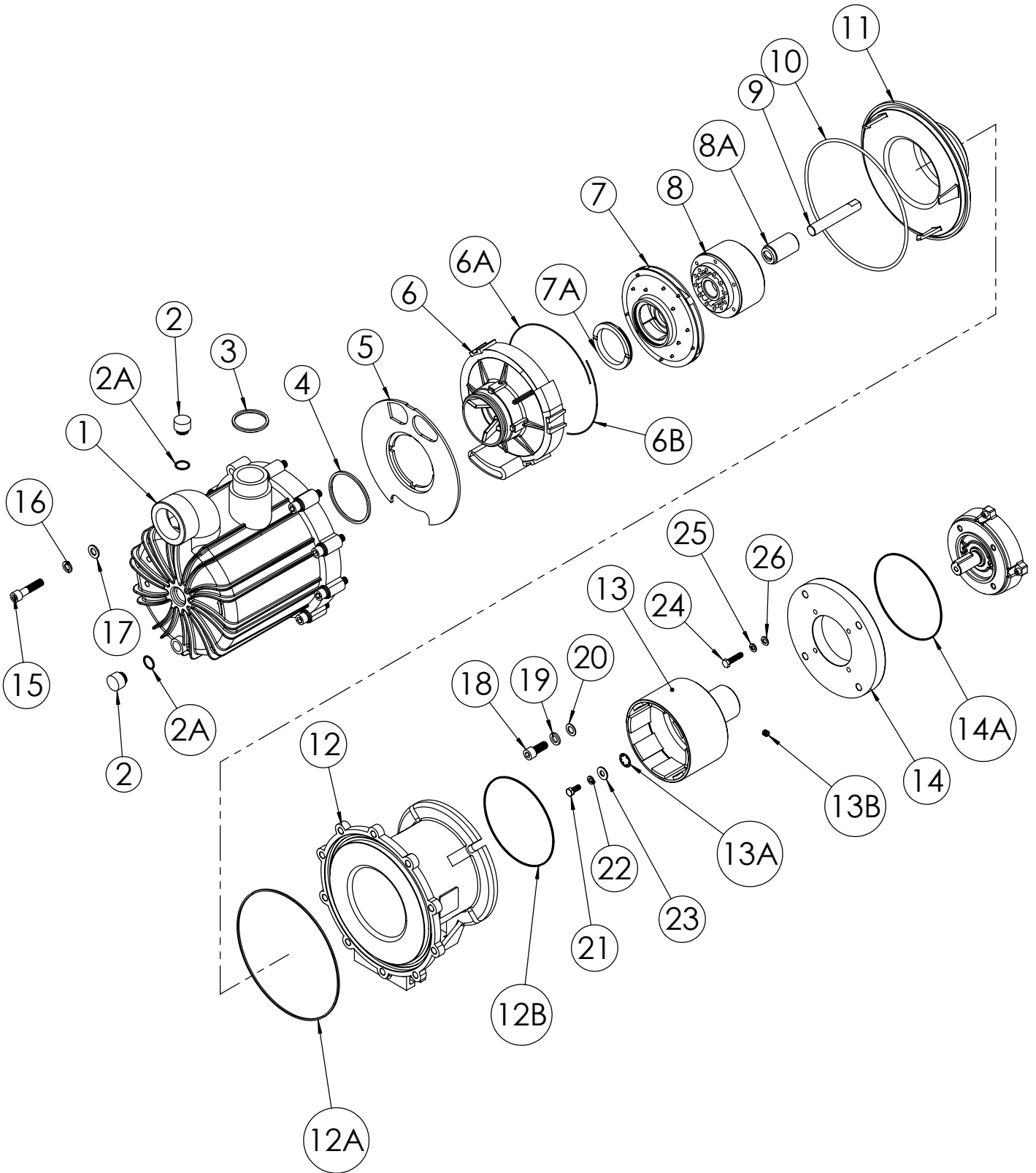

**SP22 Spare Parts List**

Item	Qty	Description	Polypropylene	PVDF
1	1	<b>Housing</b>		
		NPT threads	106437	106437-1
		BSP threads	106437-2	106437-3
		FRP flanges 2" x 2" - ANSI150/PN20/40/JIS10K	106750	106750-1
		FRP flanges 3" x 2" - ANSI150/PN20/40/JIS10K	107115-2	107115-3
		Steel flanges 2" x 2" - ANSI150/PN20/40/JIS10K	106750-2	106750-3
		Unions	106749	106749-1
2	2	<b>Fill/Drain Plug</b>		
			106143	106143-1
2A	2	<b>Fill/Drain Plug O-Ring</b>		
		FKM		106155
		EPDM		106154
3	1	<b>Discharge O-ring (BSP Housings Only)</b>		
		FKM		105083
		EPDM		105084
4	1	<b>Inner Volute O-Ring</b>		
		FKM		106770
		EPDM		106771
5	1	<b>Separator Plate</b>		
			106438	106438-1
6	1	<b>Inner Volute w/ SiC Thrust Ring &amp; Volute/Barrier Seal (Inner Volute matches impeller trim)</b>		
		#1 impeller (7.00") w/ FKM seal	107459	107459-1
		#1A impeller (6.88") w/ FKM seal	107459-8	107459-9
		#1B impeller (6.75") w/ FKM seal	107459-10	107459-11
		#1C impeller (6.63") w/ FKM seal	107459-12	107459-13
		#2 impeller (6.50") w/ FKM seal	107459-2	107459-3
		#2A impeller (6.38") w/ FKM seal	107459-14	107459-15
		#2B impeller (6.25") w/ FKM seal	107459-16	107459-17
		#2C impeller (6.13") w/ FKM seal	107459-18	107459-19
		#3 impeller (6.00") w/ FKM seal	107459-4	107459-5
		#3A impeller (5.88") w/ FKM seal	107459-20	107459-21
		#3B impeller (5.75") w/ FKM seal	107459-22	107459-23
		#3C impeller (5.63") w/ FKM seal	107459-24	107459-25
		#4 impeller (5.50") w/ FKM seal	107459-6	107459-7
		#4A impeller (5.38") w/ FKM seal	107459-26	107459-27
		#4B impeller (5.25") w/ FKM seal	107459-28	107459-29
		#4C impeller (5.13") w/ FKM seal	107459-30	107459-31
		#5 impeller (5.00") w/ FKM seal	107459-32	107459-33
		#1 impeller (7.00") w/ EPDM seal	107462	107462-1
		#1A impeller (6.88") w/ EPDM seal	107462-8	107462-9
		#1B impeller (6.75") w/ EPDM seal	107462-10	107462-11
		#1C impeller (6.63") w/ EPDM seal	107462-12	107462-13
		#2 impeller (6.50") w/ EPDM seal	107462-2	107462-3
		#2A impeller (6.38") w/ EPDM seal	107462-14	107462-15
		#2B impeller (6.25") w/ EPDM seal	107462-16	107462-17
		#2C impeller (6.13") w/ EPDM seal	107462-18	107462-19
		#3 impeller (6.00") w/ EPDM seal	107462-4	107462-5
		#3A impeller (5.88") w/ EPDM seal	107462-20	107462-21
		#3B impeller (5.75") w/ EPDM seal	107462-22	107462-23
		#3C impeller (5.63") w/ EPDM seal	107462-24	107462-25
		#4 impeller (5.50") w/ EPDM seal	107462-6	107462-7
		#4A impeller (5.38") w/ EPDM seal	107462-26	107462-27
		#4B impeller (5.25") w/ EPDM seal	107462-28	107462-29
#4C impeller (5.13") w/ EPDM seal	107462-30	107462-31		
#5 impeller (5.00") w/ EPDM seal	107462-32	107462-33		

Item	Qty	Description	Polypropylene	PVDF
6A	1	<b>Volute / Barrier Seal - 16-1/8" length</b>		
		FKM		107458
		EPDM		107458-1
6B	1	<b>Volute / Barrier Seal - 8" length</b>		
		FKM		107457
		EPDM		107457-1
7	1	<b>Impeller Assembly with Thrust Ring</b> <i>See SP22 Impeller Assemblies Table</i>		
7A	1	<b>SP22 Closed Impeller Thrust Ring Only</b>		
		Fluorosint		106950
		SiC		106951
8	1	<b>Impeller Drive Assembly</b>		
		With carbon bushing	106476	106476-1
		With PTFE bushing	106476-2	106476-3
		With silicon carbide bushing	106476-4	106476-5
8A	1	<b>Impeller Bushing Only</b>		
		Carbon		J103917-1
		Filled PTFE		106757
		SiC		106757-1
9	1	<b>Impeller Shaft</b>		
		Ceramic		106450
		SiC		106450-1
		Hastelloy C		106450-2
10	1	<b>Housing O-ring</b>		
		EPDM		106765
		FKM		106764
11	1	<b>Barrier</b>		
			106400-2	106400-3
12	1	<b>Motor Adapter</b>		
			106414-1	106414-2
12A	1	<b>Front Motor Adapter O-Ring</b>		
		Buna Std.		106844
		EPDM		106845
		FKM		106846
12B	1	<b>Rear Motor Adapter O-Ring</b>		
		Buna Std.		106847
		EPDM		106848
		FKM		106849
13	1	<b>Outer Drive Magnet Assembly with Retaining Ring</b>		
		143/145TC frame (includes set screws)		106457-3
		182/184TC frame (includes set screws)		106453
		213/215TC frame (includes set screws)		106453-1
		90 frame		106457
		100/112 frame		106457-1
		132 frame		106457-2
13A	1	<b>Retaining Ring Only</b>		
		145TC frame		105709
		184TC frame		105710
		213TC frame		106454
		90 frame		105712
		100/112 frame		105710
		132 frame		106468

Item	Qty	Description	Polypropylene	PVDF
13B	2	<b>Set Screws</b>		
		NEMA frames only		J101084
14	1	<b>Motor Adapter Flange</b>		
		213/215TC	106775	106775-1
		90 B14	106781	106781-1
		90 B5	106780	106780-1
		100/112 B14 & 143/145TC	106777	106777-1
		100/112 B5	106776	106776-1
		132 B14	106779	106779-1
14A	1	<b>Motor Adapter Flange O-Ring (NEMA 213/215 Frame Motors Only)</b>		
		Buna		108165
		EPDM		108166
		FKM		108167

**HARDWARE - ALL SP22 MODELS**

Item	Qty	Description	Stainless Steel	Titanium
15	10	<b>Housing Bolt</b>		
			106758	106759
16	10	<b>Housing Lock Washer</b>		
			106503	106504
17	10	<b>Housing Flat Washer</b>		
			106505	106506
18	4	<b>Motor Adapter Bolt</b>		
		All available frame sizes except 213/215TC	106495	106498
		213/215 TC	106511	106512
19	4	<b>Motor Adapter Lockwasher</b>		
			J101023	106499
20	4	<b>Motor Adapter Flatwasher</b>		
			106497	106500
21	1	<b>Drive Bolt (IEC Only)</b>		
		90 frame	105770	105771
		100/112 frame	105774	105775
		132 frame	106507	106508
22	1	<b>Drive Lockwasher (IEC Only)</b>		
		90 frame	J102282	J103847
		100/112 frame	105757	105758
23	1	<b>Drive Flatwasher (IEC Only)</b>		
		90 frame	105722	105772
		100/112 frame	J101360	106200
24*	4	<b>Motor Adapter Flange Bolt (for IEC with B14 flange and 143/145TC Frames Only)</b>		
		90 Frame	108029	106513
		100/112 Frame	105589	106514
		132 Frame	105774	105775
25*	4	<b>Motor Adapter Lock Washer (for IEC with B14 flange only)</b>		
		90 Frame	J102282	J103847
		100/112 Frame	J102282	J103847
		132 Frame	105757	105758
26*	4	<b>Motor Adapter Flat Washer (for IEC with B14 flange only)</b>		
		90 Frame	J101293	J103845
		100/112 Frame	J101293	J103845
		132 Frame	N/A	N/A

\*Customer must supply motor adapter flange bolt, lock washer and flat washer for IEC frame motors with B5 flanges



### SP22 Impeller Assemblies

Thrust Ring	Impeller Material	#1	#1A	#1B	#1C	#2	#2A	#2B	#2C	#3	#3A
		7.00"	6.88"	6.75"	6.63"	6.50"	6.38"	6.25"	6.13"	6.00"	5.88"
PTFE	Polypro	106746	106746-10	106746-12	106746-14	106746-2	106746-16	106746-18	106746-20	106746-4	106746-22
	PVDF	106746-1	106746-11	106746-13	106746-15	106746-3	106746-17	106746-19	106746-21	106746-5	106746-23
SiC	Polypro	106747	106747-10	106747-12	106747-14	106747-2	106747-16	106747-18	106747-20	106747-4	106747-22
	PVDF	106747-1	106747-11	106747-13	106747-15	106747-3	106747-17	106747-19	106747-21	106747-5	106747-23
Thrust Ring	Impeller Material	#3B	#3C	#4	#4A	#4B	#4C	5	-	-	-
		5.75"	5.63"	5.50"	5.38"	5.25"	5.13"	5.00"	-	-	-
PTFE	Polypro	106746-24	106746-26	106746-6	106746-28	106746-30	106746-32	106746-8	-	-	-
	PVDF	106746-25	106746-27	106746-7	106746-29	106746-31	106746-33	106746-9	-	-	-
SiC	Polypro	106747-24	106747-26	106747-6	106747-28	106747-30	106747-32	106747-8	-	-	-
	PVDF	106747-25	106747-27	106747-7	106747-29	106747-31	106747-33	106747-9	-	-	-

All impeller diameters listed in inches.

## Section VI - Troubleshooting

### General Notes:

- Cold water will contain dissolved air. Under high lift applications, the air can come out of solution blocking suction passages. This can lead to lack of priming, slow priming or low flow rates.
- Do not pump liquids containing ferrous metal fines.
- If magnets decouple, stop pump immediately. Operating the pump with the magnets decoupled will eventually weaken the magnets.
- Contact our Technical Service Department at 1-800-888-3743 or by e-mail at [techservice@finishthompson.com](mailto:techservice@finishthompson.com) if you have any questions regarding product operation or repair.

### No or Insufficient Discharge

- Air leaks in suction piping
- Housing not filled with priming fluid
- Suction pipe smaller than 3 inches
- Suction pipe contains high spots causing trapped air pockets
- Suction pipe excessively long (flow drops as suction pipe gets longer)
- System head higher than anticipated
- Closed valve
- Viscosity or specific gravity too high
- Motor too large for magnet coupling rating (magnets uncoupled)
- Suction lift too high or insufficient NPSH
- Clogged suction line, suction strainer (if used) or impeller vanes

### Insufficient Pressure

- Air or gas entrained liquid
- Impeller diameter too small
- System head lower than anticipated
- Motors speed insufficient (too low) or motor rotation incorrect (correct rotation when viewed from the fan end is clockwise)

### Won't Prime

- Did not fill housing with fluid before initially starting pump
- Closed discharge valve (valve should be open or open air vent line)
- Leak in suction piping
- Suction pipe not submerged enough (causing a vortex or exposing the end of the suction pipe)
- Lift exceeds pump ability (see Capabilities section)
- Suction pipe diameter too large
- Specific gravity or local atmospheric pressure (altitude/elevation) not accounted for in lift calculations
- Mismatch of inner volute and impeller diameter
- Inner volute o-ring chemically attacked, cut, brittle, etc.
- Motor rotation incorrect (correct rotation when viewed from the fan end is clockwise)

- Check valve installed too close to the pump.

### Primes Slowly

- Mismatch of inner volute and impeller diameter
- Suction pipe diameter too large (larger than 3 inches)
- Closed discharge valve (valve should be open)
- Inner volute o-ring chemically attacked, cut, brittle, etc.

### Excessive Power Consumption

- Head lower than rating
- Excessive flow
- Specific gravity or viscosity too high.

### Vibration/Noise

- Loose magnet
- Drive magnet rubbing
- Pump cavitating from improper suction or feed
- Motor or piping not properly secured
- Foreign object in impeller

## Section VII - Warranty

Finish Thompson, Inc (manufacturer) warrants this pump product to be free of defects in materials and workmanship for a period of five years from date of purchase by original purchaser. If a warranted defect, which is determined by manufacturer's inspection, occurs within this period, it will be repaired or replaced at the manufacturer's option, provided (1) the product is submitted with proof of purchase date and (2) transportation charges are prepaid to the manufacturer. Liability under this warranty is expressly limited to repairing or replacing the product or parts thereof and is in lieu of any other warranties, either expressed or implied. This warranty does apply only to normal wear of the product or components. This warranty does not apply to products or parts broken due to, in whole or in part, accident, overload, abuse, chemical attack, tampering, or alteration. The warranty does not apply to any other equipment used or purchased in combination with this product. The manufacturer accepts no responsibility for product damage or personal injuries sustained when the product is modified in any way. If this warranty does not apply, the purchaser shall bear all cost for labor, material and transportation.

Manufacturer shall not be liable for incidental or consequential damages including, but not limited to process down time, transportation costs, costs associated with replacement or substitution products, labor costs, product installation or removal costs, or loss of profit. In any and all events, manufacturer's liability shall not exceed the purchase price of the product and/or accessories.

### Warranty Registration

Thank you for your purchase of this quality Finish Thompson product. Be sure to take a minute to register your pump at [Finishthompson.com/warranty](http://Finishthompson.com/warranty). Simply provide the model number, serial number and a few other pieces of information.

### Ordering Spare Parts

Spare parts can be ordered from your local distributor. Always refer to the pump model to avoid error.



**FINISH THOMPSON INC.**

921 Greengarden Road • Erie, PA 16501-1591 U.S.A.  
Ph 814-455-4478 • Fax 814-455-8518

Email [fti@finishthompson.com](mailto:fti@finishthompson.com) • [www.finishthompson.com](http://www.finishthompson.com)

Tech Service 1-800-888-3743

Part Number 106783, R19, 4/20/2020



Order Online: [www.PumpCatalog.com](http://www.PumpCatalog.com)