



LMI[®]

an Accudyne Industries brand



Excel[™] XR Series

Electronic Metering Pump

Installation & Operation Manual

Manual No.: 54630

Revision : 01

Rev. Date: 07/2016

Note: For enhanced control features see manual 54772



LMI[®]

an Accudyne Industries brand

Excel™ XR Series Model Selection Table

XRD		Excel™ XR Series	
Control Code			
1	Manual Control		
9	Enhanced Control		
Output Code		Max. Capacity@ Max Pressure	Max. Pressure ¹
2	5.6 GPH (21.2 l/h)		175 psi (12.0 bar) Note: High viscosity option 150 psi (10.3 bar)
3	14.0 GPH (53.0 l/h)		75 psi (5.0 bar)
4	18.0 GPH (68.1 l/hr)		50 psi (3.5 bar)
Voltage Code			
1	110 - 120 VAC 1 Phase US Plug		
2	220 - 240 VAC 1 Phase US Plug		
3	220 - 240 VAC 1 Phase DIN Plug		
5	220 - 240 VAC 1 Phase UK Plug		
6	220 - 240 VAC 1 Phase Australia / New Zealand Plug		
7	220 - 240 VAC 1 Phase Swiss Plug		
8	110 - 120 VAC 1 Phase No Plug		
Liquid End Type			
A	Standard Liquid End		
V	High Viscosity Liquid End		
S	Slurry Liquid End		
Head Material			
1	316L Stainless Steel		
2	PVC		
4	Polypropylene		
7	PVDF		
Head Size Code			
4	Size 4 Diaphragm		
6	Size 6 Diaphragm		
Seat Material			
A	TFE/P		
T	PTFE		
V	FKM		
1	316L Stainless Steel		

Excel™ XR Series Model Selection Table (5.6 GPH)

5.6 GPH (21.2 l/h) 175 psi (12.0 bar)¹ Note: High viscosity option 150 psi (10.3 bar)

XRD		Excel™ XR Series										
Control and Output Code												
12		Manual Control Unit										
92		Enhanced Control Unit										
Voltage Code												
1		110 - 120 VAC 1 Phase US Plug										
2		220 - 240 VAC 1 Phase US Plug										
3		220 - 240 VAC 1 Phase DIN Plug										
5		220 - 240 VAC 1 Phase UK Plug										
6		220 - 240 VAC 1 Phase Australia / New Zealand Plug										
7		220 - 240 VAC 1 Phase Swiss Plug										
8		110 - 120 VAC 1 Phase No Plug										
Liquid End Codes		Type	Head	Check Valve Cartridge	Diaphragm	Diaphragm O Ring	Seat	Balls	O Ring	Fittings	Connection	Tubing Kit (see table)
	A44ACA7T1	Std	PP	PVDF	PTFE/PVDF	FKM	TFE/P	Ceramic	TFE/P	PVDF	Tube Imperial	1
	A44ACA7PN	Std	PP	PVDF	PTFE/PVDF	FKM	TFE/P	Ceramic	TFE/P	PVDF	1/2" NPT/BSP	-
	A44A1A7T1	Std	PP	PVDF	PTFE/PVDF	FKM	TFE/P	316L	TFE/P	PVDF	Tube Imperial	1
	A44A1A7PN	Std	PP	PVDF	PTFE/PVDF	FKM	TFE/P	316L	TFE/P	PVDF	1/2" NPT/BSP	-
	A44ACA7M2	Std	PP	PVDF	PTFE/PVDF	FKM	TFE/P	Ceramic	TFE/P	PVDF	Tube Metric	2
	A44A1A7M2	Std	PP	PVDF	PTFE/PVDF	FKM	TFE/P	316L	TFE/P	PVDF	Tube Metric	2
	A44ACA2FN	Std	PP	PVDF	PTFE/PVDF	FKM	TFE/P	Ceramic	TFE/P	PVDF/PVC	DN15 Female	-
	A44A1A2FN	Std	PP	PVDF	PTFE/PVDF	FKM	TFE/P	316L	TFE/P	PVDF/PVC	DN15 Female	-
	A74TCA7T1	Std	PVDF	PVDF	PTFE/PVDF	FKM	PTFE	Ceramic	TFE/P	PVDF	Tube Imperial	1
	A74TCA7PN	Std	PVDF	PVDF	PTFE/PVDF	FKM	PTFE	Ceramic	TFE/P	PVDF	1/2" NPT/BSP	-
	A74TCA7M2	Std	PVDF	PVDF	PTFE/PVDF	FKM	PTFE	Ceramic	TFE/P	PVDF	Tube Metric	2
	A74TCA2FN	Std	PVDF	PVDF	PTFE/PVDF	FKM	PTFE	Ceramic	TFE/P	PVDF/PVC	DN15 Female	-
	A74TCA7DN	Std	PVDF	PVDF	PTFE/PVDF	FKM	PTFE	Ceramic	TFE/P	PVDF	DN15 Male	-
	A1411V1PN	Std	316L	316L	PTFE/316L	FKM	316L	316L	FKM	316L	NPT	-
	S1414V1PN	Slurry	316L	316L	PTFE/316L	FKM	316L	440C	FKM	316L	NPT	-
	V44T1N4T3	Hi Vis	PP	PP	PTFE/PVDF	FKM	PTFE	316L	-	PP	Tube Imperial	3
XRD	92	1	A44ACA7T1 Complete Product Code									

(1) 175 psi (12 bar) max. with 1/4"x1/2" reinforced PVC hose or 6x12mm reinforced PVC hose; 150 psi (10 bar) max. with 3/8" PE tube or 8mm PE tube.

Excel™ XR Series Model Selection Table (14.0 GPH)

14.0 GPH (53.0 l/h)		75 psi (5.0 bar)										
XRD	Excel™ XR Series											
Control and Output Code												
13	Manual Control Unit											
93	Enhanced Control Unit											
Voltage Code												
1	110 - 120 VAC 1 Phase US Plug											
2	220 - 240 VAC 1 Phase US Plug											
3	220 - 240 VAC 1 Phase DIN Plug											
5	220 - 240 VAC 1 Phase UK Plug											
6	220 - 240 VAC 1 Phase Australia / New Zealand Plug											
7	220 - 240 VAC 1 Phase Swiss Plug											
8	110 - 120 VAC 1 Phase No Plug											
	Liquid End Codes	Type	Head	Check Valve Cartridge	Diaphragm	Diaphragm O Ring	Seat	Balls	O Ring	Fittings	Connection	Tubing Kit (see table)
	A44ACA7T1	Std	PP	PVDF	PTFE/PVDF	FKM	TFE/P	Ceramic	TFE/P	PVDF	Tube Imperial	1
	A44ACA7PN	Std	PP	PVDF	PTFE/PVDF	FKM	TFE/P	Ceramic	TFE/P	PVDF	1/2" NPT/BSP	-
	A44A1A7T1	Std	PP	PVDF	PTFE/PVDF	FKM	TFE/P	316L	TFE/P	PVDF	Tube Imperial	1
	A44A1A7PN	Std	PP	PVDF	PTFE/PVDF	FKM	TFE/P	316L	TFE/P	PVDF	1/2" NPT/BSP	-
	A44ACA7M2	Std	PP	PVDF	PTFE/PVDF	FKM	TFE/P	Ceramic	TFE/P	PVDF	Tube Metric	2
	A44A1A7M2	Std	PP	PVDF	PTFE/PVDF	FKM	TFE/P	316L	TFE/P	PVDF	Tube Metric	2
	A44ACA2FN	Std	PP	PVDF	PTFE/PVDF	FKM	TFE/P	Ceramic	TFE/P	PVDF/PVC	DN15 Female	-
	A44A1A2FN	Std	PP	PVDF	PTFE/PVDF	FKM	TFE/P	316L	TFE/P	PVDF/PVC	DN15 Female	-
	A74TCA7T1	Std	PVDF	PVDF	PTFE/PVDF	FKM	PTFE	Ceramic	TFE/P	PVDF	Tube Imperial	1
	A74TCA7PN	Std	PVDF	PVDF	PTFE/PVDF	FKM	PTFE	Ceramic	TFE/P	PVDF	1/2" NPT/BSP	-
	A74TCA7M2	Std	PVDF	PVDF	PTFE/PVDF	FKM	PTFE	Ceramic	TFE/P	PVDF	Tube Metric	2
	A74TCA2FN	Std	PVDF	PVDF	PTFE/PVDF	FKM	PTFE	Ceramic	TFE/P	PVDF/PVC	DN15 Female	-
	A74TCA7DN	Std	PVDF	PVDF	PTFE/PVDF	FKM	PTFE	Ceramic	TFE/P	PVDF	DN15 Male	-
	A1411V1PN	Std	316L	316L	PTFE/316L	FKM	316L	316L	FKM	316L	NPT	-
	S1414V1PN	Slurry	316L	316L	PTFE/316L	FKM	316L	440C	FKM	316L	NPT	-
	V44T1N4T3	Hi Vis	PP	PP	PTFE/PVDF	FKM	PTFE	316L	-	PP	Tube Imperial	3
XRD	93	1	A44ACA7T1	Complete Product Code								

Excel™ XR Series Model Selection Table (18.0 GPH)

18.0 GPH (68.1 l/hr)		50 psi (3.5 bar)											
XRD	Excel™ XR Series												
Control and Output Code													
14	Manual Control Unit												
94	Enhanced Control Unit												
Voltage Code													
1	110 - 120 VAC 1 Phase US Plug												
2	220 - 240 VAC 1 Phase US Plug												
3	220 - 240 VAC 1 Phase DIN Plug												
5	220 - 240 VAC 1 Phase UK Plug												
6	220 - 240 VAC 1 Phase Australia / New Zealand Plug												
7	220 - 240 VAC 1 Phase Swiss Plug												
8	110 - 120 VAC 1 Phase No Plug												
	Liquid End Codes	Type	Head	Check Valve Cartridge	Diaphragm	Seat	Balls	O Ring	Fittings	Connection	Tubing Kit (see table)		
	A46VCN4PN	Std	PP	PP	PTFE	FKM	Ceramic	-	PP	NPT	-		
	A46VCN4TN	Std	PP	PP	PTFE	FKM	Ceramic	-	PP	Tube Imperial	-		
	A46V1N4PN	Std	PP	PP	PTFE	FKM	316L	-	PP	NPT	-		
	A46V1N4TN	Std	PP	PP	PTFE	FKM	316L	-	PP	Tube Imperial	-		
	A46V1N2FN	Std	PP	PP	PTFE	FKM	316L	-	PP/PVC	DN15 Female	-		
	A46VCN2FN	Std	PP	PP	PTFE	FKM	Ceramic	-	PP/PVC	DN15 Female	-		
	A76VCN7PN	Std	PVDF	PVDF	PTFE	FKM	Ceramic	-	PVDF	NPT	-		
	A76VCN7TN	Std	PVDF	PVDF	PTFE	FKM	Ceramic	-	PVDF	Tube Imperial	-		
	A76VCN2FN	Std	PVDF	PVDF	PTFE	FKM	Ceramic	-	PVDF/PVC	DN15 Female	-		
	A1611V1PN	Std	316L	316L	PTFE	316L	316L	FKM	316L	NPT	-		
	S1614V1PN	Slurry	316L	316L	PTFE	316L	440C	FKM	316L	NPT	-		
	V46T1N4P4	Hi Vis	PP	PP	PTFE	PTFE	316L	-	PP	NPT	4		
	V46T1N4T4	Hi Vis	PP	PP	PTFE	PTFE	316L	-	PP	Tube Imperial	4		
XRD	94	1	A46TCN4PN	Complete Product Code									

Tubing & Connection Kits	
Kit #	Included Parts
1	1 Injection valve
	1 Foot valve
	1 Weight (suction tubing)
	16' PE tube 3/8"
	20' Reinforced PVC hose 1/4"x1/2"
2	1 Injection valve
	1 Foot valve
	1 Weight (suction tubing)
	6m PE tube 8mm
	6m Reinforced PVC hose 6x12mm
3	1 Injection valve
	2m Reinforced PVC hose 15x23mm (Suction)
	3m PE tube 1/2" (Discharge)
	1 Suction hose fitting (1/2" FNPT X 15x23) & 2 Hose clamps
4	2m Reinforced PVC hose 15x23mm (Suction)
	1 Suction hose fitting (1/2" FNPT X 15x23) & 2 Hose clamps

Table of Contents

1.0	Precautions	1
2.0	Introduction	4
2.1	Specifications	4
2.2	Unpacking Check List	5
3.0	Installation	6
3.1	Pump Location and Installation	6
3.2	Pump Mounting	6
3.2.1	<i>Flooded Suction</i>	7
3.3	Tubing Connections	8
3.4	Foot Valve / Suction Tubing Installation	10
3.5	Injection Check Valve and Discharge Tubing Installation	11
4.0	Operation	12
4.1	Controls, Inputs and Outputs	12
4.2	Display Screen and Keypad	12
4.2.1	<i>Pump Start / Stop</i>	13
4.2.2	<i>Full Capacity Operation</i>	13
4.2.3	<i>Multi-Function Buttons</i>	13
4.2.4	<i>Notification Bar</i>	13
4.2.5	<i>Display Navigation</i>	14
4.2.6	<i>Icons</i>	14
4.3	Manual Mode	16
4.4	Settings	16
4.4.1	<i>Prime Settings</i>	17
4.4.2	<i>Firmware Information</i>	17
4.4.3	<i>Calibration</i>	17
4.4.4	<i>Time / Day</i>	17
4.4.5	<i>Keypad Lock Functions</i>	18
4.4.6	<i>Set Liquid Measure Units</i>	19
4.4.7	<i>LCD Brightness</i>	20
4.4.8	<i>Reload Factory Defaults</i>	20
4.4.9	<i>Power Loss Options</i>	21
4.4.10	<i>Totalizer</i>	21
4.4.11	<i>Change Language</i>	22
4.4.12	<i>Slow Mode</i>	23
4.4.13	<i>Configure Input</i>	23

4.5	Start-Up / Priming.....	25
4.6	Calibration.....	27
5.0	Spare Parts Replacement and Routine Maintenance.....	30
5.1	Depressurizing the Discharge Line.....	30
5.2	Diaphragm Replacement.....	30
5.3	Cartridge Valve and O-ring Replacement.....	32
5.4	Injection Check Valve Parts Replacement.....	33
6.0	Troubleshooting.....	35

Table of Figures

Figure 1: Flooded Suction Pump Mount	7
Figure 2: Ferrule Assembly	9
Figure 3: Foot Valve / Suction Tubing Installation	10
Figure 4: Typical Injection Check Valve Installation	11
Figure 5: Notification Bar	13
Figure 6: Settings	14
Figure 7: Home Screen	16
Figure 8: Settings	16
Figure 9: Firmware Rev.	17
Figure 10: Time/Day	17
Figure 11: Lock Password	18
Figure 12: Password Entry Block	19
Figure 13: Set Unit	19
Figure 14: LCD Brightness	20
Figure 15: Factory Default	20
Figure 16: Factory Default Reset Verification	21
Figure 17: Power Loss Options	21
Figure 18: Totalizer	22
Figure 19: Change Language	22
Figure 20: Slow Mode Settings	23
Figure 21: Configure Input	24
Figure 22: Input Diagram	25
Figure 23: Pin Diagram	25
Figure 24: Prime Settings	26
Figure 25: Pump Calibration (Set Flow Rate)	27
Figure 26: Pump Calibration (Start Flow)	28
Figure 27: Graduated Cylinder	28
Figure 28: Pump Calibration	29
Figure 29: Pump Assembly	31
Figure 30: Diaphragm Replacement (Full Out)	31
Figure 31: Diaphragm Replacement (Full In)	32
Figure 32: Injection Check Valve Assembly	34

1.0 Precautions

The following precautions should be taken when working with LMI metering pumps. Please read this section carefully prior to installation.

Protective Clothing



ALWAYS wear protective clothing, face shield, safety glasses and gloves when working on or near your metering pump. Additional precautions should be taken depending on the solution being pumped. Refer to Safety Data Sheets (SDS) precautions from your solution supplier.

Water Pre-Prime



All LMI pumps are pre-primed with water when shipped from the factory. If your solution is not compatible with water, disassemble the Pump Head Assembly. Thoroughly dry the pump head, valves, O-rings, balls and diaphragm. Reassemble head assembly tightening screws in a crisscross pattern. Refill the pump head with the solution to be pumped before priming the pump. (This will aid in priming.)

Liquid Compatibility



CAUTION: The evaluation performed by ETL was tested with water only. The pumps are certified to NSF 61 with: sodium hypochlorite (12.5%), sulfuric acid (98.5%), sodium hydroxide (50%), and hydrochloric acid (30%). Determine if the materials of construction included in the liquid handling portion of your pump are adequate for the solution (chemical) to be pumped. Always refer to the solution supplier and the Milton Roy Chemical Resistance Chart for compatibility of your specific Milton Roy metering pump. Contact your local Milton Roy distributor for further information.

Tubing Connections



Inlet and outlet tubing or pipe sizes must not be reduced. Outlet tubing size must not be increased. Make certain that all tubing is SECURELY ATTACHED to fittings prior to start-up (see section 3.3 Tubing Connections). ALWAYS use LMI supplied tubing with your pump, as the tubing is specifically designed for use with the pump fittings. It is recommended that all tubing be shielded and secure to prevent possible injury in case of rupture or accidental damage. If tubing is exposed to sunlight, black UV resistant tubing should be installed. Check tubing frequently for cracks and replace as necessary.

Fittings and Machine Threads



All fittings should be hand-tightened. An additional 1/8 - 1/4 turn after the fitting is snug may be necessary to provide a leak-proof seal. Excessive overtightening or use of a pipe wrench can cause damage to the fittings, seals, or pump head.

Most LMI pumps have straight screw machine threads on the head and fittings and are sealed by the O-rings. DO NOT use PTFE tape or pipe dope to seal these threads. PTFE Tape may only be used on NPT threads.

Plumbing



Always adhere to your local plumbing codes and requirements. Be sure installation does not constitute a cross connection. Check local plumbing codes for guidelines. LMI is not responsible for improper installations.

PRECAUTIONS

Back Pressure/Anti-Syphon Valve



If you are pumping downhill or into low or no system pressure, a backpressure /anti-syphon device should be installed to prevent over pumping or syphoning. Contact your LMI distributor for further information.

Electrical Connections



WARNING: To reduce the risk of electrical shock, the metering pump must be plugged into a properly grounded grounding-type receptacle with ratings conforming to the data on the pump control panel. The pump must be connected to a good ground. **Do notu se adapes!** All wiring must conform to local electrical codes. If the supply cord is damaged, it must be replaced by the manufacturer, stocking distributor, or authorized repair center in order to avoid a hazard.

Fuse and Battery



CAUTION: Battery may explode if mistreated. Do not recharge, disassemble or dispose of in fire. The battery and fuse are internal, factory serviceable parts, and must be replaced by the factory or a qualified distributor with parts of the same type and rating.

Flooding



WARNING: Install this pump in a location where flooding cannot occur.

Ground Fault Circuit Interrupter



WARNING: To reduce the risk of electric shock, install only on a circuit protected by a Ground Fault Circuit Interrupter (GFCI).

Line Depressurization



To reduce the risk of chemical splash during disassembly or maintenance, all installations should be equipped with line depressurization capability.

Over Pressure Protection



To ensure safe operation of the pump it is recommended that some type of safety / pressure-relief valve be installed to protect the piping and other system components from failing due to excessive pressure.

Chemical Concentration



There is a potential for elevated chemical concentration during periods of no flow, for example, during backwash in the system. Steps, such as turning the pump off, should be taken during operation or installation to prevent this.

See your distributor about other external control options to help mitigate this risk.

Retightening Components



Plastic materials will typically exhibit creep characteristics when under pressure over a period of time and to insure a proper fit it may be necessary to retighten the head bolts periodically. To insure proper operation, we recommend tightening the bolts to 25 inch-pounds after the first week of operation and on a monthly basis thereafter.

PRECAUTIONS

Flow Display



The accuracy of the flow value as shown on the pump display is highly dependent on the specific application. Calibration is necessary in order to display an accurate measure of the flow.

Spills



CAUTION: Spills of Dangerous chemicals should be cleaned up immediately.

2.0 Introduction

LMI's metering pumps deliver the highest level of repetitive accuracy and reliability with the capability to pump a wide range of chemicals. Our comprehensive selection of pumps means you get the right pump for the right application. Every one of our pumps is engineered to exceed expectations and is backed by a global network of highly trained field engineers and aftersales support.

Please review the manual carefully. Pay particular attention to warnings and precautions. Always follow good safety procedures, including the use of proper clothing, eye and face protection.

2.1 Specifications

Table 1: General Specifications

Ingress protection	IP65 / NEMA 4X
Voltage / Frequency	100-240 V / 50-60 Hz
Max. Current / Wattage	0.42 A / 42 W
Operation environment	Indoor / Outdoor
Process fluid temperature	-10°C to +40°C
Operating ambient temperature	-10°C to +40°C
Storage temperature	-40°C to +70°C
Operating humidity range:	0-95% RH (Non-condensing)
Repeatability accuracy	+/- 1%
Turndown	1000:1 (200:1 PTFE Seat, 500:1 FKM Seat)

Table 2: Liquid End Specifications

Output Code	Max. Flow ⁽¹⁾		Max. Press		Stroke Length	Max. Stroke Speed	Max. Viscosity			Max. Suction Lift		Max. Suction Inlet Pressure		Min. Pressure Differential (Suction to Discharge)	
							Standard Liquid Ends	High Viscosity Liquid Ends							
								Polymer	Other Products						
-	[GPH]	[l/h]	[psi]	[bar]	[mm]	[SPM]	[cP]			[ft]	[m]	[psi]	[bar]	[psi]	[bar]
2	5.6	21.2	175 ⁽²⁾⁽³⁾	12 ⁽²⁾⁽³⁾	3	151	50	1250	250	13.1	4	30	2	30	2
3	14.0	53.0	75	5	6	162	50	1250	250	13.1	4	30	2	30	2
4	18.0	68.1	50	3.5	3	144	50	1250	250	6.5	2	30	2	30	2

(1) Maximum flow rate at maximum pressure. Maximum flow rate may be higher at lower pressures.

(2) 175 psi (12 bar) max. with 1/4"x1/2" reinforced PVC hose or 6x12mm reinforced PVC hose;
150 psi (10 bar) max. with 3/8" PE tube or 8mm PE tube.

(3) High viscosity option 150 psi (10.3 bar).

UNPACKING CHECK LIST

2.2 Unpacking Check List

Your carton will contain many or all of the following items. Please notify the carrier immediately if there are any signs of damage to the pump or its parts.



Metering Pump



Foot Valve

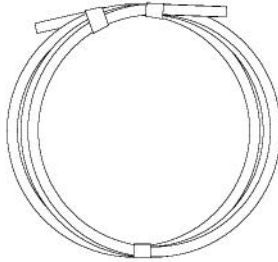

Tubing (0 or 2 Rolls)



Ceramic Foot Valve Weight



Injection Check Valve



External Control Cable
(6 Pin, 5 Pin, or 4 Pin Cables)



Tube Connection Hardware

3.0 Installation

3.1 Pump Location and Installation

Locate pump in an area convenient to solution tank and electrical supply.

The pump should be accessible for routine maintenance, and should not be operated in ambient temperatures above 104°F (40°C). If the pump will be exposed to direct sunlight, LMI black, UV resistant tubing should be installed.

3.2 Pump Mounting

The pump can be mounted in one of two ways:

- **Flooded Suction** (ideal installation); or
- **Suction Lift** - when suction lift is less than specified in section 2.1 Specifications and the fluid has a specific gravity of water and viscosity of less than 50 cPs (centipoise). For denser or more viscous solutions, consult distributor.

Note that suction conditions can affect the performance of the pump. This effect is more pronounced with lower pressure pumps. Consult your distributor for additional information.

Your LMI metering pump must be mounted so that the suction and discharge valves are vertical.



NEVER position pump head and fittings horizontal!

3.2.1 Flooded Suction

For flooded suction, the pump is mounted at the base of the storage tank. This installation is the most trouble-free, and is recommended for very low outputs, solutions that gasify, and high-viscosity solutions. Since the suction tubing is filled with solution, priming is accomplished quickly and the chance of losing prime is reduced. A foot valve is not necessary in a flooded suction installation.



When pumping downhill or into a low or no pressure system, a backpressure / anti-syphon device should be installed to prevent over pumping or syphoning.

Although popular for all solutions, LMI recommends flooded suction installations for all high-viscosity fluid applications.



INCORRECT

Avoid this type of false flooded suction

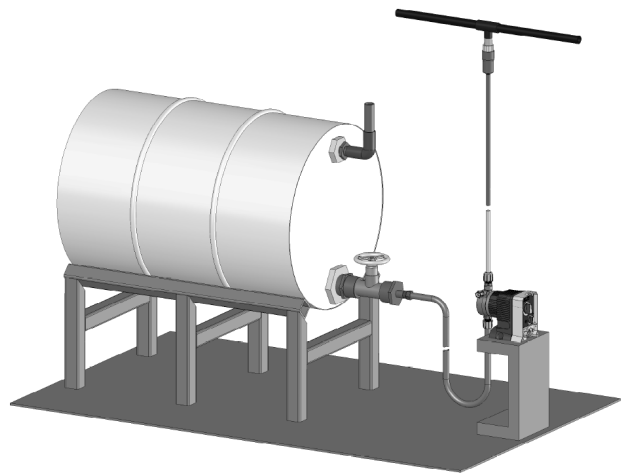

CORRECT

Figure 1: Flooded Suction Pump Mount

3.3 Tubing Connections

Use only LMI supplied tubing with your pump, as the tubing is specifically designed for use with the pump fittings. Before installation, all tubing must be cut with a clean square end. Valve and head connections from the factory are capped or plugged to retain pre-prime water. Remove and discard these caps or plugs before connecting tubing.



DO NOT USE PLIERS OR PPE WRENCH ON COUPLING NUTS OR FITTINGS.

DO NOT REUSE FERRULES — USE ONLY NEW FERRULES.

1. Insert tubing through coupling nut. Tubing should enter the smaller end of the coupling nut first, orienting the larger opening of the coupling nut toward the tubing end.
2. Position a female ferrule about 1 in (25 mm) from end of tubing. For 3/8 in and 8 mm tubing, orient the raised collar of the female ferrule toward the coupling nut.
3. Insert the male ferrule onto the end of the tube, pushing the tube into the bottom of the groove or base.
4. Slide the female ferrule down the tubing and with your fingers, press tightly into the male ferrule (Figure 2).
5. Firmly hand tighten the Coupling Nut onto the fitting.

NOTE: Tightening with pliers may cause the ferrules to break.

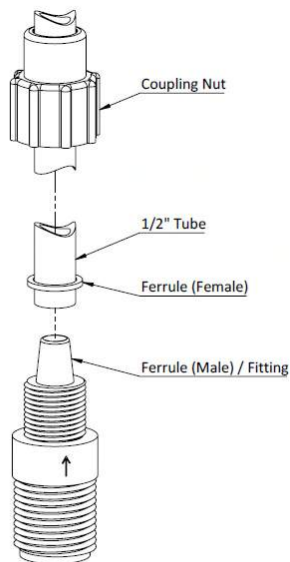

Inch Tubing (1/2")

Replacement ferrules and coupling nuts are available as the following kit numbers:

54714 - 3/8" TUBE

54715 - 1/4"x1/2" HOSE

54716 - 8mm TUBE

54717 - 6x12mm HOSE

54718 - 1/2" TUBE

One kit is needed for each end of the tube.

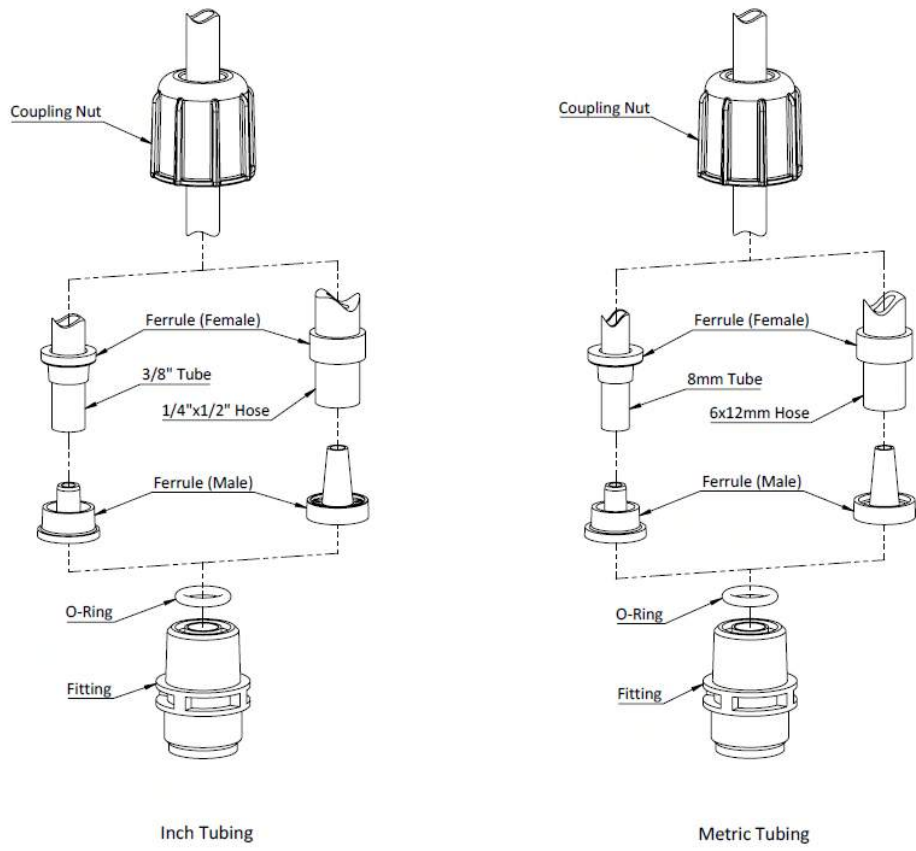

Figure 2: Ferrule Assembly

3.4 Foot Valve / Suction Tubing Installation

The foot valve acts as a check valve to keep the pump primed in suction lift applications.

The foot valve is designed to be submersed in the solution tank or drum and must sit in a vertical position at the bottom. Position approximately 2 in (50 mm) above the bottom of the tank or drum sediment layer.

The ceramic weight, when installed, helps position the foot valve in a vertical position.

1. Attach the foot valve to one end of the suction tubing (see section 3.3 Tubing Connections).
2. Slide the ceramic weight over the tubing end until it contacts the top of the foot valve coupling nut.
3. Place foot valve and tubing into the solution tank. Check that the foot valve is vertical and approximately 2 in (50 mm) from the bottom of the tank or drum (Figure 3). Connect the other end of the tubing to the suction side of the pump head (bottom side) (see section 3.3 Tubing Connections).

Note: Pump models equipped with high-viscosity liquid ends are not equipped with foot valves. Flooded suction is recommended. A 1/2 in NPT connector is included for flooded suction installations.

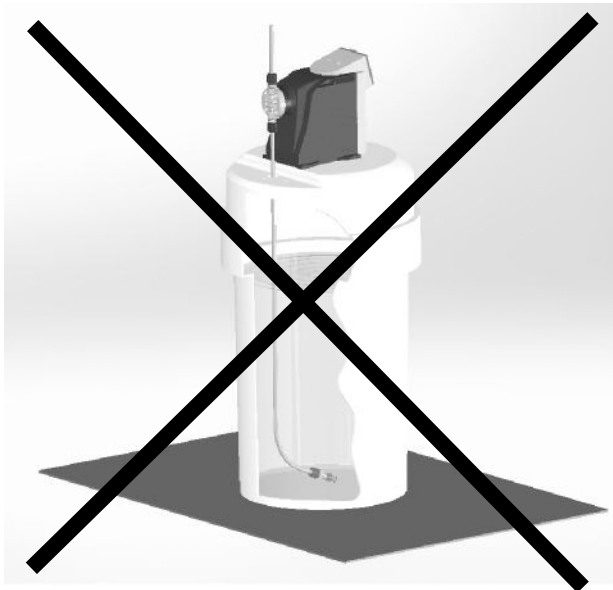

INCORRECT

Foot Valve tilted sideways *WILL NOT PRIME*

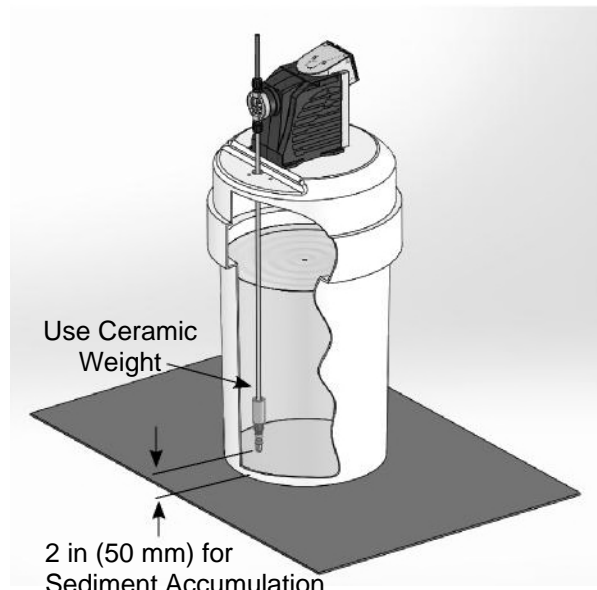

CORRECT

Foot Valve must remain vertical

Figure 3: Foot Valve / Suction Tubing Installation

3.5 Injection Check Valve and Discharge Tubing Installation

The injection check valve prevents backflow from a treated line.

1. Install the injection check valve at the location where chemical is being injected into the system. Any size female NPT fitting or pipe tee with a reducing bushing to $\frac{1}{2}$ in female NPT will accept the injection check valve. PTFE tape should only be used on threads that are connected with pipes.
2. When installing the injection check valve, be sure to position it so that the valve enters the bottom of your pipe in a vertical position. Variations left and right within 80° are acceptable (Figure 4).
3. After cutting an appropriate length of tubing, connect tubing to the injection check valve then back to the discharge side of the pump head. Make sure it does not crimp or come into contact with hot or sharp surfaces (see section 3.3 Tubing Connections).

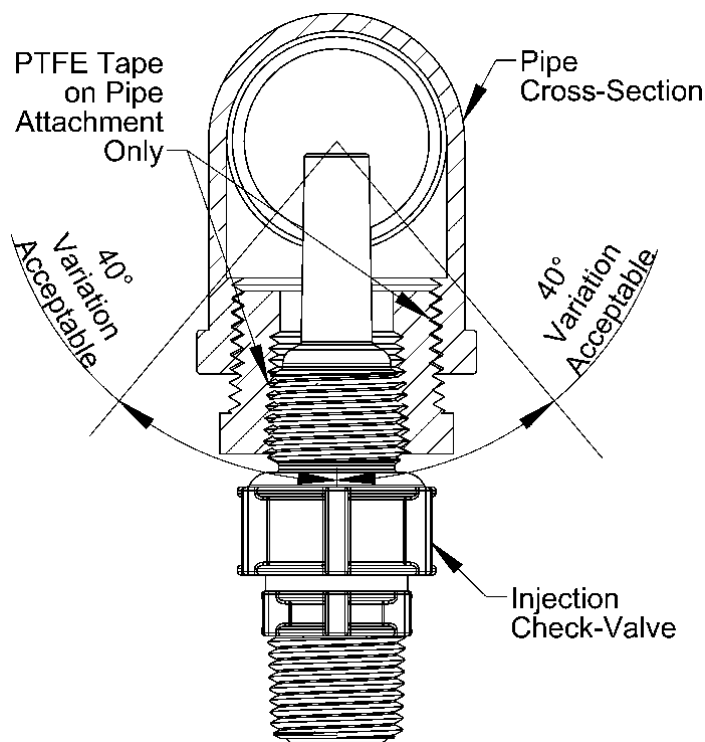
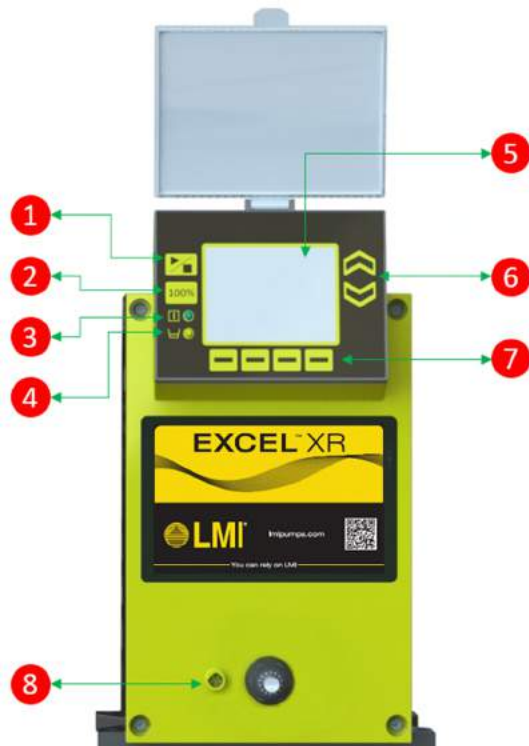

Figure 4: Typical Injection Check Valve Installation

4.0 Operation

This manual covers features supported in the manual control model Excel™ XR Series pumps.

4.1 Controls, Inputs and Outputs



1. Start / Stop Button: Starts or stops the pump. It affects only the pumping function. The pump is always powered when it is plugged in.
2. Full Capacity Button: Sends the pump output to 100% regardless of current settings.
3. Pump Status Indicator: Glows green constantly when pump is operating, including between strokes.
4. Low Level Indicator: Glows amber when tank sensor detects a low fluid level.
5. LCD Display: Shows current pump status, operating mode, settings, alarms, etc.
6. Up / Down Multi-Function Buttons: Function varies with the active display screen. Used for incrementing, decrementing and navigation.
7. Multi-Function Buttons: Function varies with the active display screen and is indicated by on-screen icons above the buttons. Used to highlight, select and navigate.
8. Input / Output Connector: This connector is used for the special functions associated with the Manual controls (e.g., Digital Input).

4.2 Display Screen and Keypad

All control input and monitoring of pump status is done using the display screen and keypad. All inputs entered while the pump is running affect pump output immediately. If changes are made while the pump is at idle, the new settings will be in effect when the pump is started.

4.2.1 Pump Start / Stop

The **Start / Stop** button toggles the pump ON and OFF, independent of other settings. When running it will operate based on the settings and external signals currently in effect. There is no need to stop the pump to change settings. When the pump is on, the pump status indicator will glow green.

4.2.2 Full Capacity Operation

If the **100%** button is pressed, the current settings and external signals will be temporarily overridden. Pump output will go immediately to full capacity and remain there. If the pump is not running when the **100%** button is pressed, it will start and run at full capacity. To exit full capacity operation, press the **Start / Stop** button to stop the pump. The previous settings will resume. Press the **Start / Stop** button again to start the pump.

4.2.3 Multi-Function Buttons

The icon above each **Multi-Function** button indicates the function the button will perform. This function varies based on the active display screen. These buttons can highlight, select, navigate or increment as needed for the current display screen function.

4.2.4 Notification Bar

The notification bar (Figure 5) provides information at a glance including status icons to indicate operating mode, alarms, etc. depending on the display screen function.

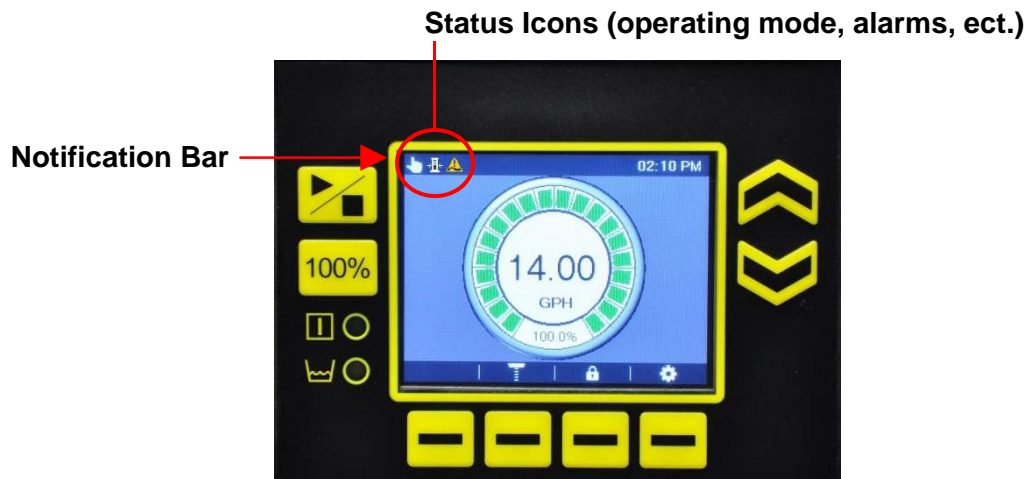

Figure 5: Notification Bar

4.2.5 Display Navigation

Navigation through display screens is done using the **Up**, **Down**, and **Multi-Function** buttons. The settings screen is shown in the example below (

Figure 6). The scroll bar on the side of the display screen indicates there are more settings available on another page.

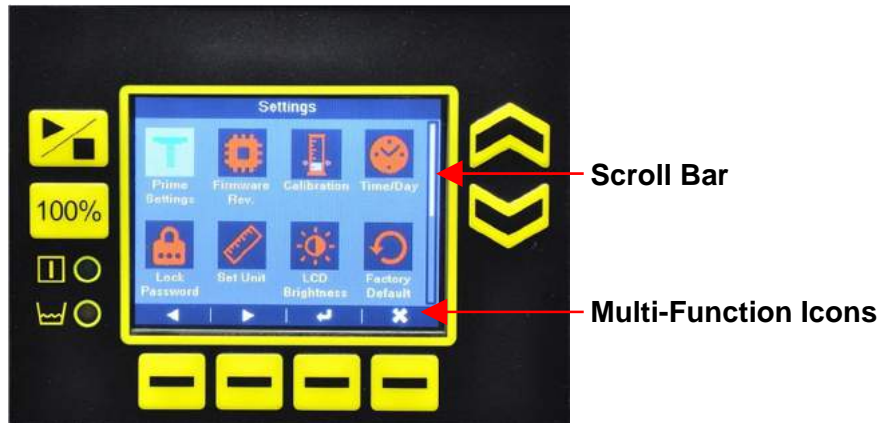























Figure 6: Settings

4.2.6 Icons

Table 3 shows the function of display screen icons.

Table 3: Pump Icons

	Manual mode (other modes not available on Manual Control pumps)
	Left
	Right
	Save
	Enter
	Exit
	Settings

	Keypad locked (see section 4.4.5 Keypad Lock Functions)
	Reset
	Pump has been calibrated (see section 4.6 Calibration)
	Slow mode active (see section 4.4.12 Slow Mode)
	Pump running at full capacity
	Prime mode (see section 4.5 Start-Up / Priming)
	Motor stalling
	Tank low level alarm (see section 4.4.13 Configure Input)
	Tank empty alarm (see section 4.4.13 Configure Input)
	Pump totals (see section 4.4.10 Totalizer)
	User totals (see section 4.4.10 Totalizer)
	Check (see section 4.4.8 Reload Factory Defaults)
	Problem homing the motor
	System error (Boot up error)

4.3 Manual Mode

In Manual mode, the pump responds to the flow rate entered by the user. A configurable external input, described in section 4.4.13 Configure Input, provides additional control.

With the home screen displayed (Figure 7) press the **Up** or **Down** buttons to increase or decrease the desired flow rate. Changes can be made while the pump is running. The flow rate value will appear in the center of the gauge display and the green segments around the perimeter will light in 5% increments. The flow rate will also be shown in percent of full capacity below the flow rate.

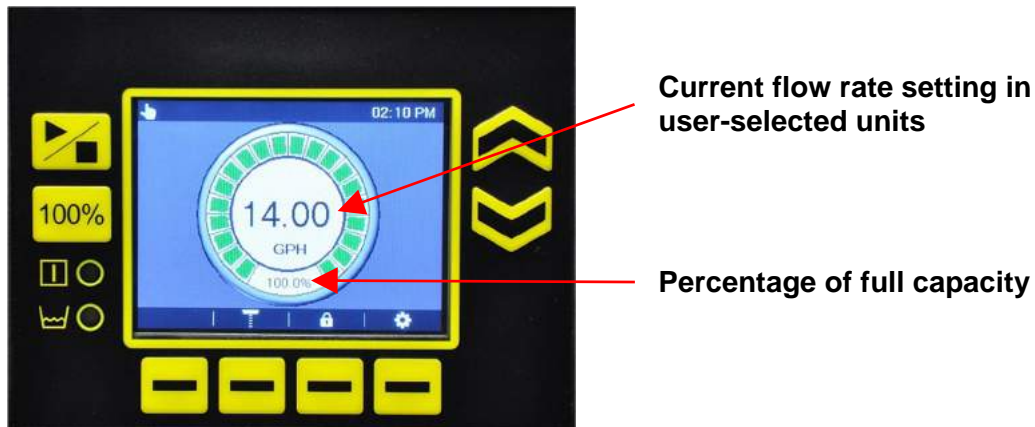

Figure 7: Home Screen

4.4 Settings





To access the settings screen (Figure 8) press **Settings**  in the home screen (Figure 7). Navigate to the function desired and press **Enter** . Follow the prompts to enter new settings. New settings will need to be saved by pressing **Save** . Press **Exit**  to return to the previous screen without saving.



Figure 8: Settings

4.4.1 Prime Settings

See section 4.5 Start-Up / Priming, for use of this screen.

4.4.2 Firmware Information

From the *Settings* screen, navigate to the **Firmware Rev.** icon and press **Enter** . The *Firmware Rev.* screen (Figure 9) will display firmware revision for several devices. This information is useful in troubleshooting or when contacting Customer Service.



Figure 9: Firmware Rev.

4.4.3 Calibration

See section 4.6 Calibration, for use of this screen.

4.4.4 Time / Day

Navigate between fields by pressing **Left**  or **Right** . On the *Time/Day* screen (Figure 10), set the time and day values by incrementing with the **Up** or **Down** buttons. Press **Save**  before exiting.



Figure 10: Time/Day

4.4.5 Keypad Lock Functions

The keypad can be locked to prevent unintentional changes, or to limit access to only those with a password (Figure 11).

KEYPAD LOCK MODES













-  Always unlocked (default)
-  All buttons locked except **Start / Stop** button; Can be unlocked by pressing **Lock** 
-  All buttons locked; Can be unlocked by pressing **Lock** 
-  All buttons locked except **Start / Stop** button; Requires password to unlock
-  All buttons locked; Requires password to unlock



Figure 11: Lock Password

1. Set the lock function and select a password by selecting the type of protection desired by highlighting the desired icon.
2. Navigate to the number field.
3. Navigate from number to number by pressing **Left**  or **Right** .
4. Select the desired password numbers with the **Up** or **Down** buttons.
5. Press **Save**  before exiting.

If the keypad lock is enabled and set to a mode that does not require a password, simply press **Lock**  to engage or disengage the keypad lock. The **Lock**  icon will appear in the Notification Bar when the keypad is locked.

If the keypad lock is enabled in a mode that requires a password, pressing **Lock**  will display the password entry block (Figure 12).





1. Navigate from number to number by pressing **Left**  or **Right** .
2. Select the number in each position with the **Up** or **Down** button.
3. Press **Enter**  to submit the completed password or **Exit**  to return to the previous screen.



Figure 12: Password Entry Block

If the password entry block remains idle for several seconds it will time out and restore the home screen.

4.4.6 Set Liquid Measure Units

This system features U.S. and metric units. Select the preferred units by pressing **Left**  or **Right**  (Figure 13) and press **Save**  to retain the setting.



Figure 13: Set Unit

4.4.7 LCD Brightness



Display brightness is increased or decreased by pressing the **Up** or **Down** buttons (Figure 14). Press **Save**  before exiting to retain the new setting.



Figure 14: LCD Brightness

4.4.8 Reload Factory Defaults

All factory default settings can be restored by pressing the **Check**  (Figure 15).

A confirmation screen will appear as a precaution (Figure 16). Use the **Up** and **Down** buttons to select, press **Check**  to proceed. This action is not reversible.



Figure 15: Factory Default



Figure 16: Factory Default Reset Verification

4.4.9 Power Loss Options

The manner of recovery from a power failure can be selected (Figure 17). The choices are:

- **Stay Idle:** Pump does not start (resume flow)
- **Resume operation:** Pump starts at the flow rate setting prior to power loss
- **Run in speed:** Pump starts at the flow rate specified



Navigate between options by pressing **Left**  or **Right** . If **Run in Speed** is selected, enter the desired speed using the **Up** or **Down** buttons. Press **Save**  to store the settings.



Figure 17: Power Loss Options

4.4.10 Totalizer

The totalizer function shows cumulative information in two modes: Pump totals and Totals since last user reset. Pump totals cannot be altered and are not reset by loading

factory defaults. View the pump totals by pressing **Pump** . View the user totals by pressing **User**  (Figure 18). Pressing **Reset**  changes all the user total values to zero.



Figure 18: Totalizer

4.4.11 Change Language

Select the desired language using the **Up** or **Down** buttons (Figure 19). Press **Save**  before exiting.

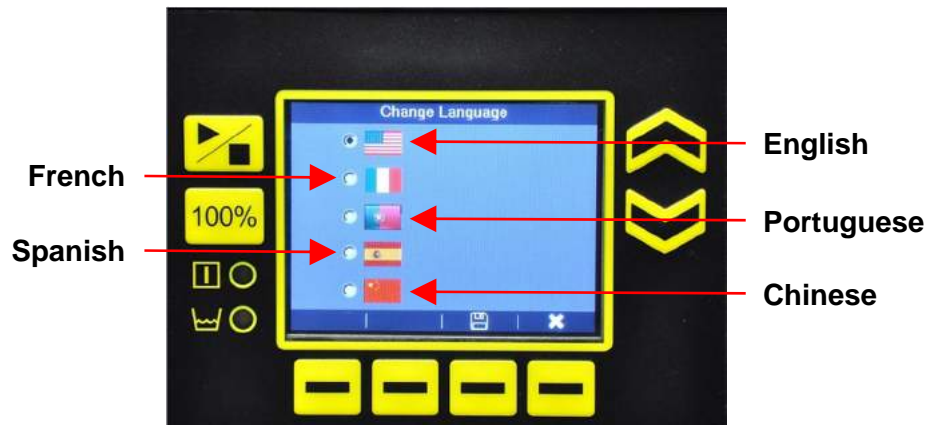

Figure 19: Change Language

4.4.12 Slow Mode

Slow mode is useful when pumping viscous fluids or those with a tendency to outgas (Figure 20). Slow mode reduces the speed of the pump motor on the suction stroke to minimize cavitation.



Press the **Up** or **Down** buttons to select the “**Slow Mode Active**” box. Press **Right**  to select the “%” box and the **Up** or **Down** buttons to enter the percentage of full capacity at which the pump should operate. Press **Save**  to retain settings.



Figure 20: Slow Mode Settings



4.4.13 Configure Input

Pumps configured for manual control (one connector on the control panel) can accept one external input (Figure 21). On a manual control pump, the external input can be assigned to one of the following functions:

Input Type	Function	Use
Digital	<Disable>	De-activates input
	Remote Start/Stop	Externally toggles start/stop
	Tank Level Switch - Empty	Triggers “Tank Empty” alarm
	Tank Level Switch - Low	Triggers “Tank Low” alarm



Figure 21: Configure Input

1. Select the type of input by pressing **Left**  or **Right** .
2. Select whether the input is “NC” (normally closed) or “NO” (normally open) with the **UP** and **Down** buttons.
3. Press **Save**  to retain the input assignment.

Operations / Indications

If configured for Remote Start / Stop, the control panel **Start / Stop** button overrides the Remote Start / Stop input. If the pump is stopped with the control panel button and the remote input is in the ON state, the pump will stop. To restart the pump remotely, the remote input must be cycled to the OFF state and back to ON again.

If the input is assigned to either of the Low Level functions, the ON state will illuminate the amber low-level indicator on the keypad. An icon will appear on the notification bar of the display to indicate that the tank is either low or empty (see section 4.2.6 Icons). If the input assignment is for Empty, the ON state will also stop the pump.

If the effect of the input is the opposite from what is desired (e.g., Low Level indication when the tank is full), return to the Configure Input screen and select the opposite of the original “NC” or “NO” entry. Press **Save** .

Connections

Input circuitry must be capable of switching 24 VDC at 15 mA (Figure 22). Minimum time in low impedance state (closed) is 25 ms. Minimum time in high impedance state (open) is 50 ms. The input is activated by making or breaking a connection between pin 3 (input) and pin 6 (ground) (Figure 23).

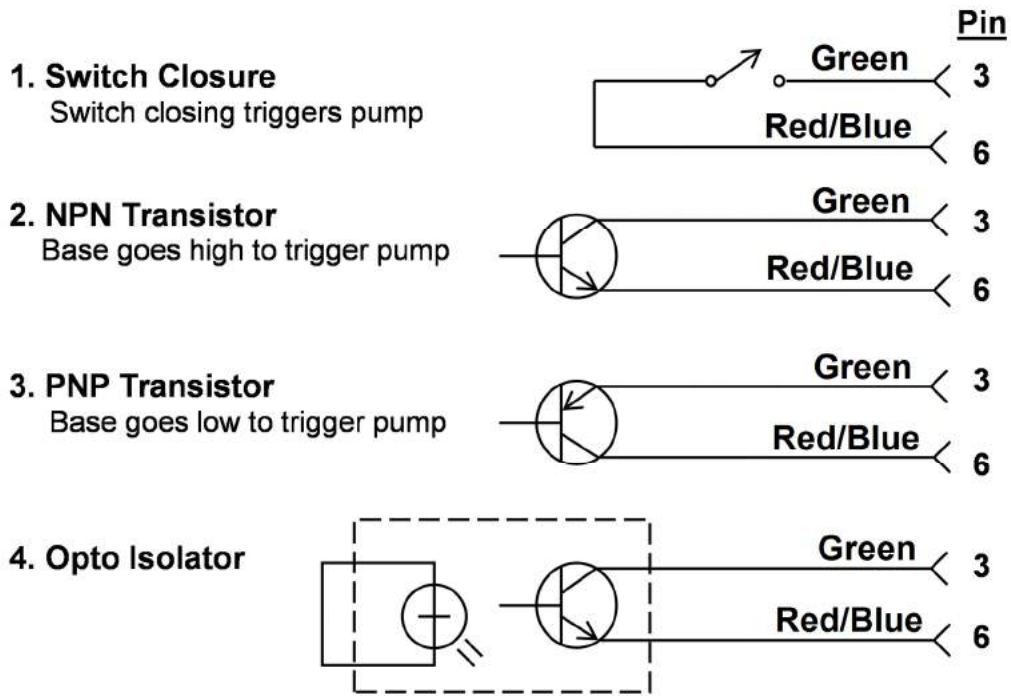

Figure 22: Input Diagram (J1)

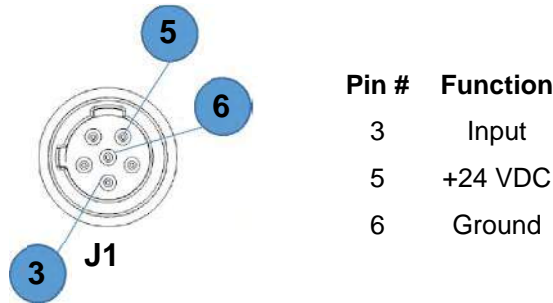





Figure 23: Pin Diagram

4.5 Start-Up / Priming

Read this entire section completely before proceeding.

Pumps are shipped from the factory with water in the pump head to aid in priming. If your solution is not compatible with water, refer to the “Water Pre-Prime” paragraph in section 1.0 Precautions. The pump is normally self-priming. The priming procedure varies with the application. Time and flow rate for priming can be adjusted to suit the user’s needs.

If suction lift is less than that specified in section 2.1 Specifications, proceed with the following steps.

1. From the *Settings* screen, select **Prime Settings** (Figure 24).
2. Press **Left**  or **Right**  to move between the Duration and Speed settings.
3. Enter the desired settings using the **Up** or **Down** buttons.
4. Press **Save**  to retain the settings. Allowable settings are as follows:

Settings	Minimum	Maximum
Duration (seconds)	1	3600
Flow Rate (user selected units)	0.01	Maximum Pump Capacity



Figure 24: Prime Settings

The pump may be primed only after all settings have been entered, all precautionary steps have been taken (see section 1.0 Precautions), and after verification that all tubing is properly attached.

1. Plug in the pump and allow it to initialize.
2. Remove pressure from the discharge line with a priming valve or other method.
3. On the home screen, press **Prime** .
4. The pump will start at the rate selected. If slow mode is active, it will apply to priming as well. The suction tubing should begin to fill with solution.
5. Once the pump is primed, it may be turned off manually or it will shut off automatically after the duration previously set.
6. Close the priming valve and stop the pump.
 - a. If the pump has trouble achieving an initial prime, remove the fitting and check valve on the discharge side of the pump head.
 - b. Pour some of the pumped solution into the port until the head is filled.
 - c. Replace the valve and fitting, then follow the priming steps again.

4.6 Calibration

The pump is equipped to display a theoretical flow rate based upon the pump's stroke speed. These calculations are based on factory test conditions, which may be significantly different from your application. The true flow rate for a given pump output setting can vary depending on many factors including: pressure, temperature, fluid medium, and system layout. It is recommended that the pump be calibrated before use under application conditions. This one-point calibration procedure will greatly improve the accuracy of the pump's theoretical flow rate display.

1. Prepare a device for accurately measuring volume such as a graduated cylinder or a scale sensitive to 1 gram. If using a graduated cylinder, make sure the fluid surface area remains constant during calibration, e.g., the fluid remains above the foot valve weight as shown in Figure 27.
2. Ensure the pump is primed following the procedure in 4.5 Start-Up / Priming. Verify that the discharge line is at normal operating pressure.
3. On the *Settings* screen, select **Calibration**. The Flow Rate box is pre-selected (Figure 25).
4. Use the **Up** or **Down** button to set a flow rate typical of normal operating conditions.



Figure 25: Pump Calibration (Set Flow Rate)

5. Take a beginning reading on the measuring device, e.g., starting fluid height, tare weight, set scale to zero, etc.
6. Press the **Start / Stop** button and the pump will start and begin counting strokes (Figure 26). Allow the pump to run as long as possible. Calibration accuracy improves with more strokes. (The maximum number of strokes is 9999.) If using a graduated cylinder with a foot valve, keep the fluid level above the valve and weight.



Figure 26: Pump Calibration (Start Flow)

7. Press the **Start / Stop** button to stop the pump. The screen will display the number of strokes and the estimated Total Volume pumped. The units of total volume are always in ml to allow a direct reading from the cylinder.
8. Take the final reading of fluid volume in ml. If using a scale, divide the difference between beginning and ending weights in grams by the specific gravity of the chemical solution being pumped. If using a graduated cylinder with a foot valve inserted (Figure 27), the readings will need to be adjusted to compensate for the presence of the suction tubing using the following formula:

$$V_{actual} = V_{observed} (1 - (D_{tube}/D_{column})^2)$$

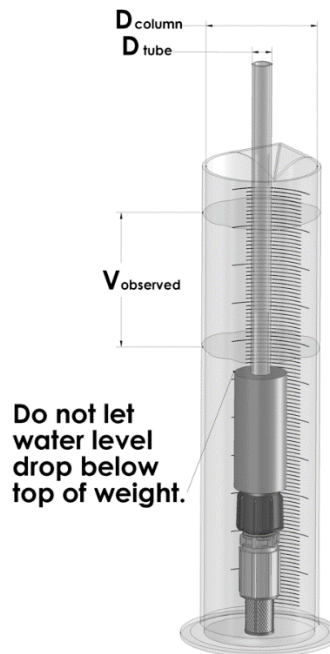

Figure 27: Graduated Cylinder

For accuracy, it is important that the water level does not drop below the top of the ceramic foot valve weight.

Noë: If you will be using the pump at a different pressure, the pump should be recalibrated under those conditions using the procedure above to ensure accuracy.

9. The total volume box will be highlighted (Figure 28). Using the **Up** or **Down** buttons, enter the actual volume measured during the calibration.

10. Press **Save** . The **Calibrated**  icon will display on the home screen.

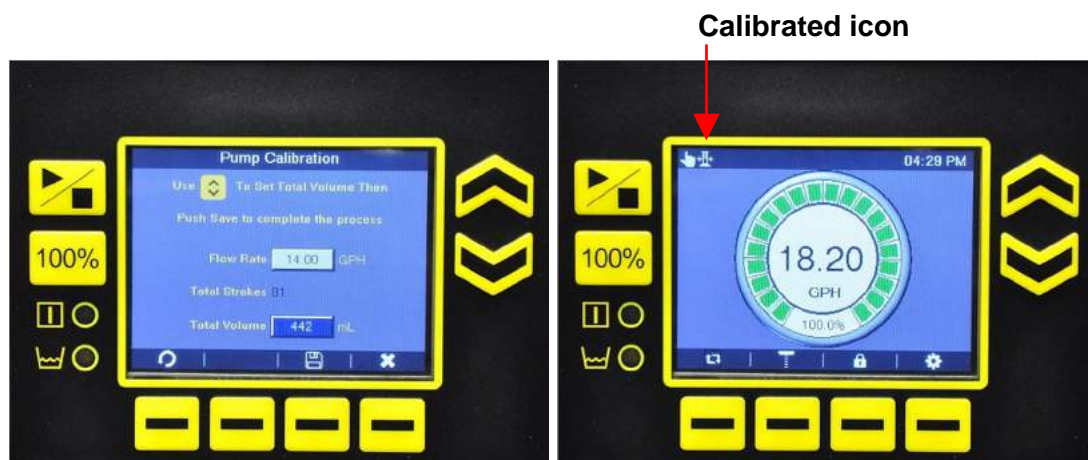



Figure 28: Pump Calibration

If at any time during the calibration procedure the process needs to be re-run, press **Reset** . If necessary, the **Calibration**  icon on the home screen can be cleared by restoring factory defaults.

NOTE: If the pump is subsequently used at a significantly different pressure, it should be recalibrated under the new conditions following the above procedure to ensure accuracy.

5.0 Spare Parts Replacement and Routine Maintenance

LMI metering pumps are designed for trouble-free operation, yet routine maintenance of elastomeric parts is essential for optimum performance. This involves replacing the diaphragm, cartridge valves, O-rings, and the injection check valve spring. LMI recommends replacing these parts at least once a year; however, frequency will depend on your particular application.

5.1 Depressurizing the Discharge Line



A L W A Y S wear protective clothing, face shield, safety glasses and gloves when working on or performing any maintenance or replacement on your pump. See SDS information from solution supplier for additional precautions.

To reduce the risk of chemical splash during disassembly or maintenance, all installations should be equipped with a depressurization capability.

Read the following before proceeding.

1. Be sure the injection check valve is properly installed and is operating. If a shut off valve has been installed downstream of the injection valve, it should be closed.
2. Be sure your relief tubing is connected to your priming/relief valve and runs back to your solution drum or tank.
3. Open the priming/relief valve until solution drains back down the discharge tubing into the solution tank or drum, and the discharge line is fully depressurized.

5.2 Diaphragm Replacement

A L W A Y S wear protective clothing, face shield, safety glasses and gloves when working on or performing any maintenance or replacement on your pump. See SDS information from solution supplier for additional precautions.

Refer to the LMI Metering Pump Price List for the proper Spare Parts Kit number or contact your local LMI stocking distributor. Spare Part Replacement Kits include specific instructions for diaphragm replacement. Please follow the instructions included with the replacement kit. When replacing the diaphragm, the cartridge valves, or O-rings, the injection check valve spring should also be replaced (see section 5.4 Injection Check Valve Parts Replacement).

1. Carefully depressurize, drain, and disconnect the discharge line (see section 5.1 Depressurizing the Discharge Line).
2. Place the foot valve or suction tube into a container of water or other neutralizing solution.
3. Turn the pump on to flush the head assembly.

- Once the pump head has been flushed, remove the foot valve or suction tube from the solution and continue to pump air into the pump head until the pump head is purged of water or neutralizing solution (Figure 29).

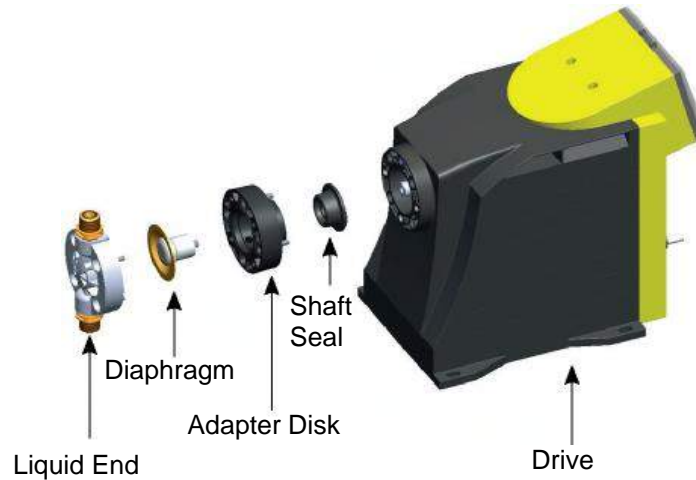

Figure 29: Pump Assembly

Noë: If the liquid cannot be pumped due to diaphragm rupture, carefully disconnect the suction and discharge tubing using protective clothing, gloves, and face shield. Immerse the head in water or other neutralizing solution.



- Remove the screws and washers from the head.
- On the *Settings* screen, select **Diaphragm Replacement** and press **Enter** .
- Press **Left**  to fully extend the diaphragm to the full out position (Figure 30).



Figure 30: Diaphragm Replacement (Full Out)

- Unscrew the diaphragm by carefully grasping the outer edge and turning it counter-clockwise. Discard old diaphragm.

9. Remove the adapter disk and check condition of the shaft seal. Replace shaft seal if necessary.
10. Replace the adapter disk so that the drain hole of the disk is oriented downward, and the mounting holes line up with the mounting holes of the pump.



Noë: Be careful not to scratch the Fluorofilm™ face of the new diaphragm.

11. Screw on the new diaphragm clockwise until turned all the way in.
12. Press **Right**  to fully retract the diaphragm to the full in position (Figure 31).
13. Remount the pump head using the screws and washers.
14. Tighten in a crisscross pattern.
15. Torque screws to 25 inch-pounds.

After one week of operation, recheck the screws and tighten if necessary.



Figure 31: Diaphragm Replacement (Full In)

5.3 Cartridge Valve and O-ring Replacement

A L W A Y S wear protective clothing, face shield, safety glasses and gloves when working on or performing any maintenance or replacement on your pump. See SDS information for solution specific disposal instructions.

Refer to the LMI Metering Pump Price List for the proper Spare Parts Kit number or contact your local LMI stocking distributor. Spare Part Replacement Kits include specific instructions for valve replacement. Please follow the instructions included with the replacement kit.

1. Carefully depressurize and disconnect the discharge line (see section 5.1 Depressurizing the Discharge Line).
2. Place the foot valve or suction tube into a container of water or other neutralizing solution.

3. Turn the pump on to flush the head assembly.
4. Once the pump has been flushed, lift the foot valve out and continue to pump to let air into the pump head until pump is purged of water or neutralizing solution.

Noë: *If the liquid cannot be pumped due to diaphragm rupture, carefully disconnect the suction and discharge tubing using protective clothing, gloves, and face shield. Remove the screws and washers from the head and immerse the head in water or other neutralizing solution.*

5. Carefully disconnect one tubing connection and fitting one at a time, then remove and replace the worn valve and O-rings. If necessary, carefully loosen stuck valves by prying side to side using a small screwdriver through the center hole of the valve. Before disassembling the check valves, note the orientation of the valve.
6. Install new check valves in each location. Ensure that the cartridges are oriented correctly.

5.4 Injection Check Valve Parts Replacement

A L W A Y S wear protective clothing, face shield, safety glasses and gloves when working on or performing any maintenance or replacement on your rpm pump. See SDS information for solution specific precautions.

Refer to the LMI Metering Pump Price List for the proper Spare Parts Kit number or contact your local LMI representative. Spare Part Replacement Kits include specific instructions for valve replacement. Please follow the instructions included with the replacement kit.

Depressurize and drain pipeline (or isolate injection check valve point using valves) so that injection check valve can safely be disassembled.

1. Isolate injection check valve and depressurize pipe or drain pipeline.
2. Carefully depressurize and disconnect the discharge line (see section 5.1 Depressurizing the Discharge Line).
3. Carefully disconnect the tubing leading to the injection check valve (Figure 32).
4. Remove the injection check valve fitting.
5. Remove and replace the worn spring, seat, ball, and O-ring.

Noë: *Before disassembling the check valve, note the orientation of the parts.*

6. Install a new spring, seat, ball, and O-ring. Ensure that the parts are oriented correctly.

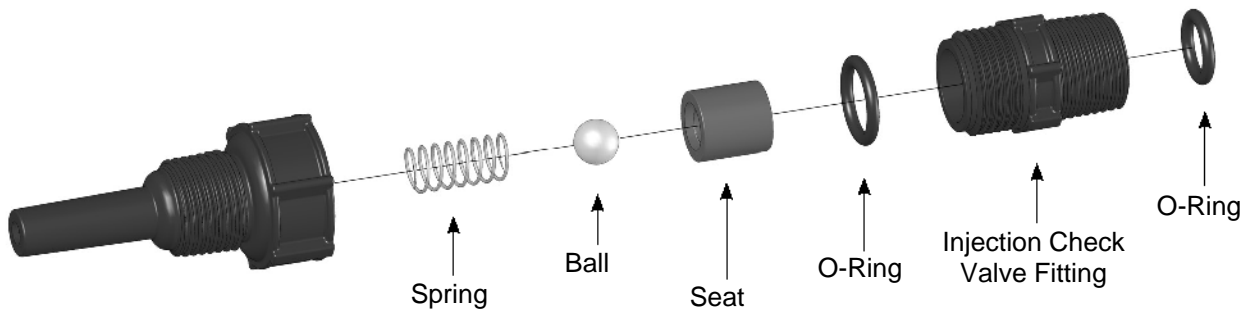

Figure 32: Injection Check Valve Assembly

6.0 Troubleshooting

PROBLEM	POSSIBLE CAUSE	SOLUTION
Pump Will Not Prime	1. Pump not turned on or plugged in	1. Turn on pump/plug in pump
	2. Foot Valve not in vertical position on bottom of tank	2. Foot valve must be vertical (see section 3.4 Foot Valve / Suction Tubing Installation)
	3. Pump suction lift too high	3. Maximum suction lift, specified in section 2.1 Specifications. High viscosity liquid handling assemblies require flooded suction
	4. Suction tubing is curved or coiled in tank	4. Suction tubing must be vertical. Use LMI ceramic weight supplied with pump (see section 3.4 Foot Valve / Suction Tubing Installation)
	5. Fittings are overtightened	5. DO NOT OVERTIGHTEN FITTINGS! This causes seal rings to distort and not seat properly which causes pump to leak back or lose prime
	6. Air trap in suction valve tubing	6. Suction tubing should be as vertical as possible. AVOID FALSE FLOODED SUCTION! (see section 3.2.1 Flooded Suction)
	7. Too much pressure at discharge	7. Shut off valves in pressurized line. Disconnect tubing at injection check valve (see section 4.4.1 Prime Settings). When pump is primed, reconnect discharge tubing
	8. Air leak around fitting	8. Check for missing or damaged O-rings at ends of fittings
Pump Loses Prime	1. Solution container ran dry	1. Refill container with solution and re-prime (see Section 4.4.1 Prime Settings)
	2. Foot Valve is not in a vertical position on the bottom of the tank	2. Foot Valve must be vertical (see section 3.4 Foot Valve / Suction Tubing Installation)
	3. Pump suction lift is too high	3. Maximum suction lift, specified in section 2.1 Specifications. High viscosity liquid handling assemblies require flooded suction
	4. Suction tubing is curved or coiled in tank	4. Suction tubing must be vertical. Use LMI ceramic weight supplied with pump (see section 3.4 Foot Valve / Suction Tubing Installation)

TROUBLESHOOTING

	5. Fittings are over tightened	5. <i>DO NOT OVERTIGHTEN FITTINGS!</i> This causes seal rings to distort and not seat properly which caused pump to leak back or lose prime
	6. Air trap in suction valve tubing	6. Suction tubing should be as vertical as possible. <i>AVOID FALSE FLOODED SUCTION!</i> (see Section 3.2.1 Flooded Suction)
	7. Air leak on suction side	7. Check for pinholes, cracks. Replace if necessary
Leakage at Tubing	1. Worn tubing ends	1. Cut about 1 in (25 mm) off tubing and then replace as before
	2. Loose or cracked fitting	2. Replace fitting if cracked. Carefully hand tighten fittings. <i>DO NOT USE PIPE WRENCH.</i> An additional 1/8 or 1/4 turn may be necessary
	3. Worn seal rings	3. Replace balls and seal rings (see section 5.3 Cartridge Valve and O-Ring Replacement)
	4. Solution attacking Liquid Handling Assembly	4. Consult your local distributor for alternate materials
Low Output or Failure to Pump Against Pressure	1. Pump's maximum pressure rating is exceeded by injection pressure	1. Injection pressure cannot exceed pump's maximum pressure. See pump data plate
	2. Worn Seal Rings	2. Worn seal rings or cartridge valves may need replacement (see section 5.3 Cartridge Valve and O-ring Replacement)
	3. Ruptured Diaphragm	3. Replace diaphragm (see section 5.2 Diaphragm Replacement)
	4. Tubing run on discharge may be too long	4. Longer tubing runs may create frictional losses sufficient to reduce pump's pressure rating. Consult factory for more information
	5. Clogged Foot Valve strainer	5. Remove Foot Valve strainer when pumping slurries or when solution particles cause strainer to clog
Failure to Run	1. Pump not turned on or plugged in	1. Turn on or plug in pump
	2. Electronic or Mechanical failure	2. Consult supplier or factory
Excessive Pump Output	1. Syphoning (Pumping downhill without an anti-siphon valve)	1. Move injection point to a pressurized location or install an anti-siphon valve
	2. Little or no pressure at injection point	2. If pressure at injection point is less than 30 psi (2.0 Bar), a backpressure valve should be installed

We are a proud member of Accudyne Industries, a leading global provider of precision-engineered, process-critical, and technologically advanced flow control systems and industrial compressors. Delivering consistently high levels of performance, we enable customers in the most important industries and harshest environments around the world to accomplish their missions.



LMI is a registered trademark of Milton Roy, LLC.
EXCEL is a trademark of Milton Roy, LLC
Fluorofilm is a trademark of Milton Roy, LLC

info@lmipumps.com
www.lmipumps.com

© 2016 Milton Roy, LLC

