





Air Operated Double Diaphragm Pump



To Purchase:

-  800-990-7867
-  sales@yamadapump.com
-  Find My Rep

More Information:

-  YouTube: @yamadapump
-  yamadapump.com
- Data Sheets | CAD Drawings | Manuals Literature | BOM | Performance Curves

Trial Program

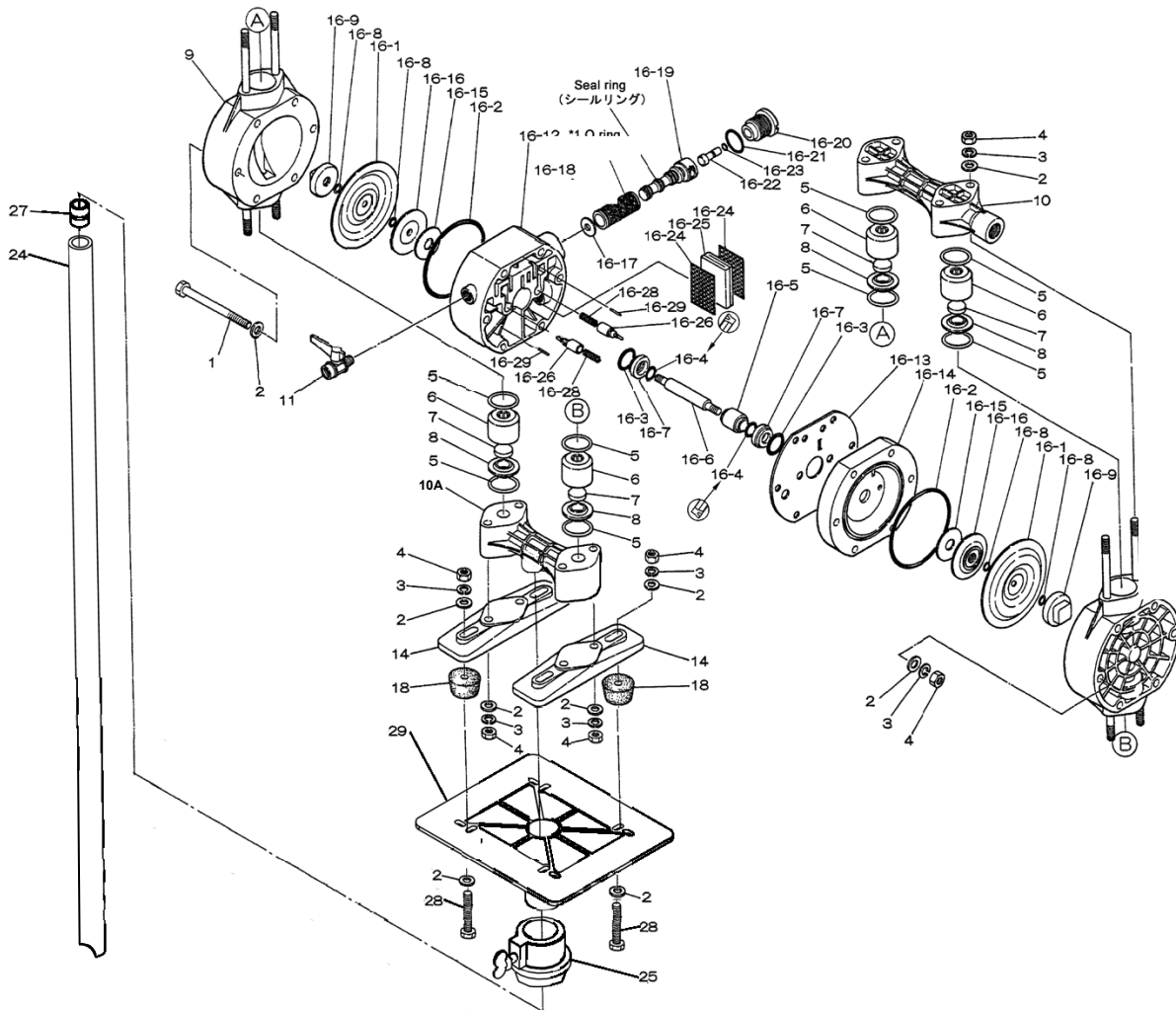

Order Online: www.PumpCatalog.com

Air Operated Double Diaphragm Pump

NPT	NDP-15FP-D	NDP-15FP-D	NDP-15FP-D	NDP-15FP-D	** NPT PUMPS **		
REF. No.	PARTS No.	PARTS No.	PARTS No.	PARTS No.	DESCRIPTION	QTY.	REORDER
1	684310	684310	684310	684310	BOLT	6	
2	631329	631329	631329	631329	PLAIN WASHER	28	
3	681300	681300	681300	681300	SPRING LOCK WASHER	18	
4	628012	628012	628012	628012	NUT	18	
5	640027	640027	684115	643027	O-RING	8	
6	771341	771341	771341	771341	VALVE STOPPER	4	
7	771340	771340	771340	771340	FLAT VALVE	4	
8	771345	771345	771345	771345	VALVE SEAT	4	
9	780119	780119	780119	780119	OUT CHAMBER	2	
10	780027	780027	780027	780027	MANIFOLD (OUTLET)	2	
10A	780196	780196	780196	780196	MANIFOLD 15P-MP (INLET)	1	
11	686826	686826	686826	686826	BALL VALVE	1	
13	621153	621153	621153	621153	BOLT	4	
14	771352	771352	771352	771352	BASE	2	
16-1	771372	770973	771972	770933	DIAPHRAGM	2	
16-2	640144	640144	640144	640144	O-RING	2	
16-3	640020	640020	640020	640020	O-RING	2	
16-4	684284	684284	684284	684284	PACKING	2	
16-5	771337	771337	771337	771337	GUIDE	1	
16-6	710578	710578	710578	710578	CENTER ROD	1	
16-7	771336	771336	771336	771336	BUSHING	2	
16-8	-	640005	-	643005	O-RING	4	
16-9	770968	770968	770968	770968	CENTER DISK (OUTER)	2	
16-12	780029	780029	780029	780029	BODY A	1	
16-13	771347	771347	771347	771347	GASKET	1	
16-14	780030	780030	780030	780030	BODY B	1	
16-15	771342	771342	771342	771342	CUSHION	2	
16-16	771344	771344	771344	771344	CENTER DISK (INNER)	2	
16-17	771483	771483	771483	771483	CUSHION	2	
16-18	804249	804249	804249	804249	SLEEVE ASSEMBLY	1	
16-18-*1	683123	683123	683123	683123	O-RING (SLEEVE O.D.)	6	
16-19	802835	802835	802835	802835	C-SPOOL VALVE ASSY.	1	
16-19 seal	771484	771484	771484	771484	SEAL RING	5	
16-20	771695	771695	771695	771695	CAP	1	
16-21	640022	640022	640022	640022	O-RING	1	
16-22	771350	771350	771350	771350	RESET BUTTON	1	
16-23	640002	640002	640002	640002	O-RING	1	
16-24	771589	771589	771589	771589	MESH	2	
16-25	771465	771465	771465	771465	SILENCER	1	
16-26	832141	832141	832141	832141	PILOT VALVE ASSY.	2	
16-28	710577	710577	710577	710577	SPRING	2	
16-29	632752	632752	632752	632752	SPRING PIN	2	
18	770551	770551	770551	770551	CUSHION	4	
24	15P-PIPE-1	15P-PIPE-1	15P-PIPE-1	15P-PIPE-1	PIPE 3/4" PVC	1	
25	15P-BUNG-1	15P-BUNG-1	15P-BUNG-1	15P-BUNG-1	DRUM PLATE BUNG ADAPTER	1	
27	15P-NIPP	15P-NIPP	15P-NIPP	15P-NIPP	NIPPLE 1/2"	1	
28	15P-BOLT	15P-BOLT	15P-BOLT	15P-BOLT	BOLT M8 X 55 X 1.25	4	
29	773337	773337	773337	773337	DRUM PUMP BASE	1	
KIT	K15-PH	K15-PN	K15-PS	K15-PT	LIQUID SIDE		
KIT	K15-AM				AIR MOTOR		

Air Operated Double Diaphragm Pump

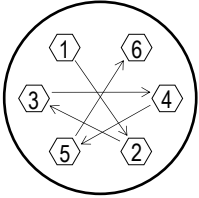
**Tightening torque for center rod and out chambers.**

Center Rod	122 in-lbf {14 N-m}
Out Chambers	105 in-lbf {12 N-m}

Tightening torque for manifold retainer bolts or nuts.

FPC/H/N/S/T	105 in-lbf {12 N-m}
-------------	---------------------

General Tools:

- Socket wrench - 13mm
- Open-end wrenches - 13mm, 21mm
- Plier

Special Tools (sold separately):

- Cap & disk remover (771132)
- Sleeve remover (713148)

Miscellaneous:

- Assembly Oil - turbine oil none additional class 1 (equivalent to ISO VG32 grade)
- Nuts - M8 x 1.25
- Urea grease grade (NLGI) No. 2

Order Online: www.PumpCatalog.com