

BERKELEY® LTH/LTM Series

Self-Priming, Cast Iron Centrifugal Pumps

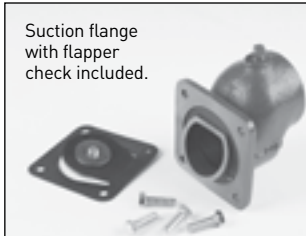

Some of the fastest priming pumps on the market. Available in high head or medium head series. Feature leak-proof mechanical seals, easy service design, heavy-duty motors, rugged construction. Available in 3 and 5 HP.

Optional 6" and 8" Trap Packages are available.

APPLICATIONS

- **Lawn Sprinkling...** operate from 1 to 30 or more heads. Can be safely operated by timer or other automatic device.
- **Contractors...** for dewatering excavation, jetting, water transfer and supply operations.
- **Agriculture...** seed bed and plot irrigation, stock watering, fire protection.
- **Industrial...** sump drainage, fire protection, marine pumping, liquid transfer and supply operations.

SPECIFICATIONS

Body and Base – Close-grained cast iron

Impeller – Silicon bronze

Diffuser – Cast iron

Shaft – Carbon steel inside removable shaft sleeve of stainless steel.

FEATURES

Heavy-duty Motors – Both high head and medium head models offer heavy-duty motors, easy service design, and air volume control tapping.

Drain Port – Provided for easy winterizing.

Medium Head Models – Deliver up to 115' of head with capacities to 159 GPM.

High Head Models – Deliver up to 138' of head with capacities to 162 GPM.

Easy Serviceability – Normal wearing parts are easily accessible for service and replacement, without disturbing piping or mounting.

Heavy-duty Motors – Designed for continuous operation. Capacitor start, will not cause electrical interference with TV or other appliances. Nationally known motors have ball bearing, stainless steel shaft. For single- and three-phase operation, 3450 RPM.

Max. Temp – 140° (60° C)

Max. Operating Pressure – 60 PSI

BERKELEY® LTH/LTM Series Self-Priming, Cast Iron Centrifugal Pumps

ORDERING INFORMATION

LTH HIGH HEAD

Catalog Number	HP	Pipe Tapping Sizes		Motor Voltage	Phase	Max. Load Amps	Approx. Wt. Lbs.
		Suction Flange	Discharge				
S40094	3	2"	1-1/2"	230	1	13.4	144
S40093	3	2"	1-1/2"	208-230/460	3	8.6/4.3	144
S40097	5	2-1/2"	2"	230	1	22	184
S40096	5	2-1/2"	2"	208-230/460	3	13.2/6.6	184

LTM MEDIUM HEAD

S40100	3	2-1/2"	2"	230	1	13.4	137
S40099	3	2-1/2"	2"	208-230/460	3	8.6/4.3	137
S40102	5	3"	2-1/2"	230	1	22	184
S40103	5	3"	2-1/2"	230/460	3	13.2/6.6	184

Consult factory for 575V.

LTH/LTM SERIES - FLANGE ADAPTERS (INCLUDED WITH PUMP)

Package 52 -	Package 53 -	Package 72 -	Package 73 -
1-1/2"	2"	2-1/2"	3"

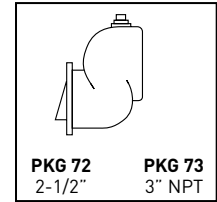
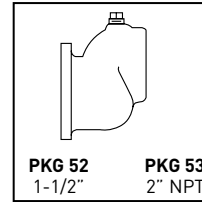

LTH/LTM SERIES - SUCTION TRAPS

Catalog Number	Description	Suction Port Size	Approx. Wt. Lbs.
PKG 51	6" Cast Iron Trap with Basket	2" NPT	20
PKG 76	Cast Iron Flange for Remote Installation	3" NPT	4
PKG 98	8" Cast Iron Trap with Basket	3" NPT	40

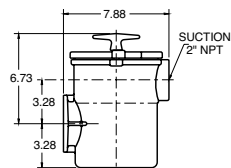

PKG 51
6 INCH TRAP



PKG 76

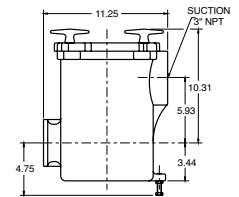

PKG 98
8 INCH TRAP

PKG 51
6"

PKG 98
8"

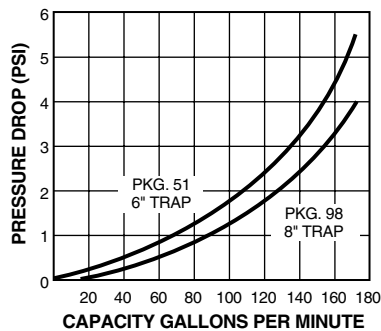

BERKELEY® LTH/LTM Series

Self-Priming, Cast Iron Centrifugal Pumps

PUMP PERFORMANCE (Capacity in Gallons Per Minute)								
LTH HIGH HEAD								
Catalog Number	HP	Discharge		Suction Lift in Feet				
		PSI	Feet Head	5'	10'	15'	20'	25'
S40094/ S40093	3	20	46.2	121	119	105	96	68
		30	69.3	106	103	98	92	66
		40	92.4	85	80	74	69	60
		50	115.5	58	51	42	32	13
S40097/ S40096	5	20	46.2	162	161	152	138	98
		30	69.3	160	158	150	136	98
		40	92.4	146	141	136	130	96
		50	115.5	119	114	105	95	85
		60	138.6	81	70	55	30	-
LTM MEDIUM HEAD								
S40099/ S40100	3	20	46.2	159	154	146	138	99
		30	69.3	126	118	110	101	86
		40	92.4	85	75	51	26	-
S40102/ S40103	5	20	46.2	214	209	202	194	162
		30	69.3	185	179	172	165	158
		40	92.4	153	146	139	130	120
		50	115.5	114	101	85	65	28

PUMP PERFORMANCE - LTH HIGH HEAD

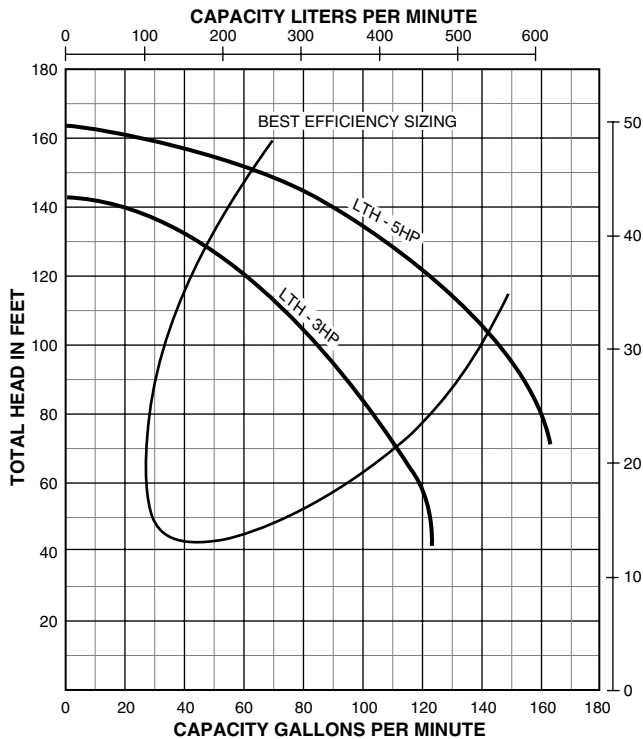

PUMP PERFORMANCE - LTM MEDIUM HEAD

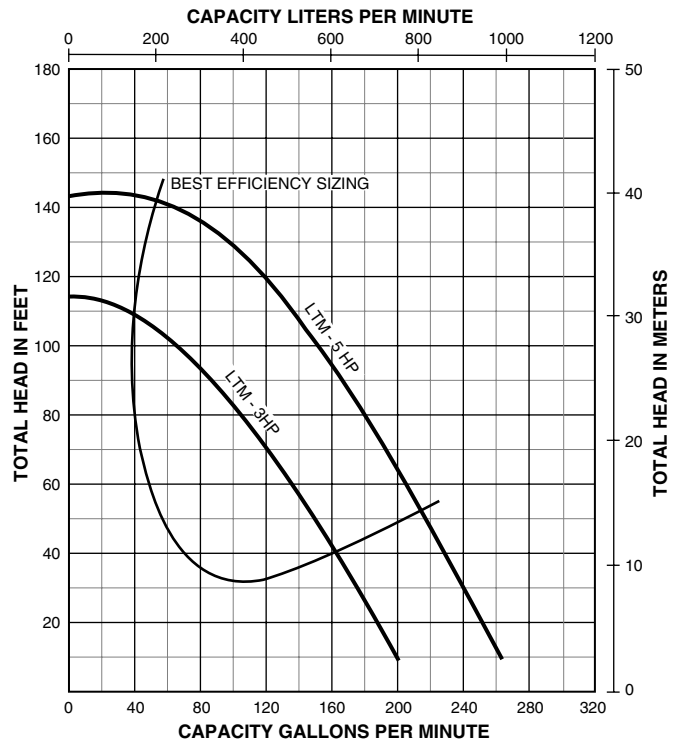

BERKELEY® LTH/LTM Series Self-Priming, Cast Iron Centrifugal Pumps

OUTLINE DIMENSIONS

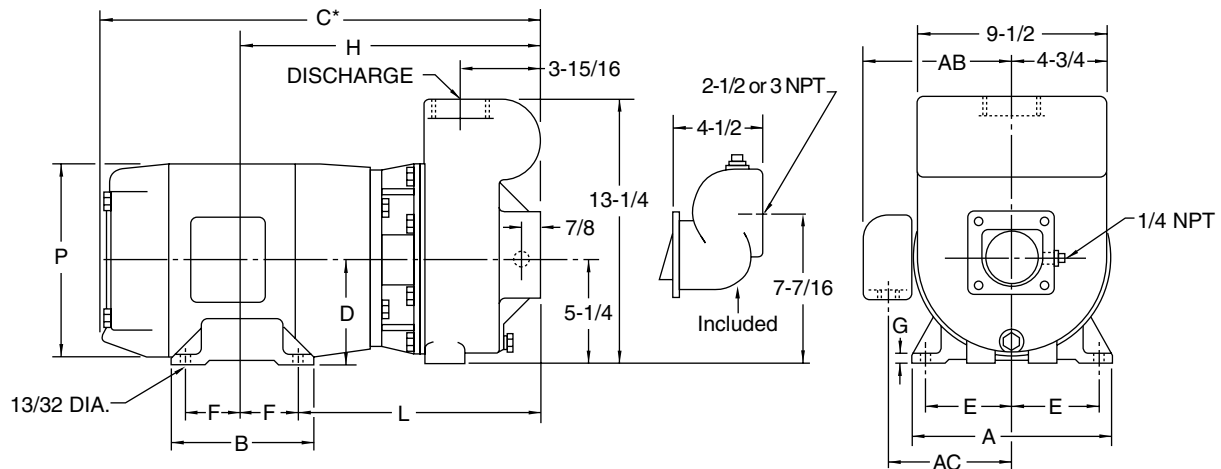

Dimensions (in inches) are for estimating purposes only.

DIMENSIONS IN INCHES

Catalog Number	HP	A	B	C*	D	E	F	G	H	L	P	AB	AC
LTH	3	9	6	20-3/4	4-1/2	3-3/4	2-1/4	1/2	15	12-3/4	9-3/4	8-1/8	6-1/2
LTH	5	9	7	21-3/4	4-1/2	3-3/4	2-3/4	1/2	15-1/2	12-3/4	9-3/4	9	7
LTM	3	9	6	20-3/4	4-1/2	3-3/4	2-1/4	1/2	15	12-3/4	9-3/4	8-1/8	6-1/2
LTM	5	9	7	21-3/4	4-1/2	3-3/4	2-3/4	1/2	15-1/2	12-3/4	9-3/4	9	7

*Overall length (C) is shown for single-phase motors. Three-phase motors are slightly smaller. Dimensions are for estimating purposes only.