

EOM

ENGINEERING OPERATION
& MAINTENANCE MANUAL

P2

Clamped Metal Pump



Where Innovation Flows



Copyright

Copyright 2018 PSG®, a Dover Company. All rights reserved.

PSG reserves the right to modify the information and illustrations in this document without prior notice. The product described in this document is furnished under a license agreement or nondisclosure agreement. No part of this document may be reproduced, stored in a retrieval system, or transmitted in any form or any means electronic or mechanical, including photocopying and recording, without the written permission of PSG, a Dover Company, except as described by the terms of those agreements.

This is a non-contractual document.

Trademarks

PSG and the PSG logo are registered trademarks of PSG. Wilden® is a registered trademark of PSG California LLC. Pro-Flo® SHIFT, Pro-Flo®, and Wil-Flex® are registered trademarks of PSG California LLC. Chem-Fuse™, Pure-Fuse™, Saniflex™, and Bunalast™ are trademarks of PSG California LLC.

All trademarks, names, logos and service marks (collectively “trademarks”) in this document are registered and unregistered trademarks of their respective owners. Nothing contained in this document should be construed as granting any license or right to use any trademark without the prior written permission of the trademark owner.

Warranty

Each and every product manufactured by Wilden is built to meet the highest standards of quality. Every pump is functionally tested to ensure integrity of operation. Wilden warrants that pumps, accessories and parts manufactured or supplied by it to be free from defects in material and workmanship for a period of five (5) years from date of installation or six (6) years from date of manufacture, whichever comes first.

For more information, and to register your Wilden pump for warranty, please visit <https://www.psgdover.com/wilden/support/warranty-registration>.

Certifications



CONTENTS

SECTION 1: Precautions – Read First! 4

SECTION 2: Wilden Pump Designation System 5

SECTION 3: How It Works 6

SECTION 4: Dimensional Drawings 7

SECTION 5: Performance 8

 P2 Metal Rubber-Fitted 8

 P2 Metal TPE-Fitted 8

 P2 Metal Reduced-Stroke PTFE-Fitted 9

 P2 Metal Full-Stroke PTFE-Fitted 9

 Suction Lift Capability 10

SECTION 6: Suggested Installation, Operation, Maintenance, and Troubleshooting 11

SECTION 7: Disassembly/Reassembly 14

 Pump Disassembly 14

 Air Valve Disassembly 16

 Reassembly Hints and Tips 18

 Shaft Seal Installation 19

SECTION 8: Exploded View and Parts List 20

SECTION 9: Elastomer Options 24

SECTION 1

PRECAUTIONS – READ FIRST!

 **WARNING:** Always wear safety glasses when operating a pump to avoid eye injury. If diaphragm rupture occurs, material being pumped may be forced out of the air exhaust.

 **CAUTION:** Do not apply compressed air to the exhaust port – pump will not function.

 **CAUTION:** Do not over-lubricate air supply– excess lubrication will reduce pump performance. Pump is pre-lubed.

 **TEMPERATURE LIMITS:**

Polypropylene	0°C to 79°C	32°F to 175°F
PVDF	-12°C to 107°C	10°F to 225°F
PFA	7°C to 107°C	20°F to 225°F
Neoprene	18°C to 93°C	0°F to 200°F
Buna-N	-12°C to 82°C	10°F to 180°F
EPDM	-51°C to 138°C	-60°F to 280°F
Bunast™	-40°C to 130°C	-40°F to 266°F
Geolast®	-40°C to 82°C	-40°F to 180°F
FKM	-40°C to 177°C	-40°F to 350°F
Wil-Flex®	-40°C to 107°C	-40°F to 225°F
Saniflex™	-29°C to 104°C	-20°F to 220°F
Polyurethane	-12°C to 66°C	10°F to 150°F
Polytetrafluoroethylene (PTFE) ¹	4°C to 104°C	40°F to 220°F
Nylon	-18°C to 93°C	0°F to 200°F
Acetal	-29°C to 82°C	-20°F to 180°F
SIPD PTFE with Neoprene-backed	4°C to 104°C	40°F to 220°F
SIPD PTFE with EPDM-backed	-10°C to 137°C	14°F to 280°F
Polyethylene	0°C to 70°C	32°F to 158°F

¹4°C to 149°C (40°F to 300°F) - 13 mm (1/2") and 25 mm (1") models only.

NOTE: Not all materials are available for all models. See "Wilden Pump Designation System" material options for your pump.

 **CAUTION:** When choosing pump materials, be sure to check the temperature limits for all wetted components. Example: FKM has a maximum limit of 177°C (350°F), but polypropylene has a maximum limit of only 79°C (175°F).

 **CAUTION:** Maximum temperature limits are based on mechanical stress only. Certain chemicals will reduce maximum safe operating temperatures significantly. Consult the Chemical Resistance Guide for chemical compatibility and temperature limits.

 **CAUTION:** All Wilden pumps are capable of passing solids. Use a strainer on the pump intake to ensure that the pump's rated solids capacity is not exceeded.

 **CAUTION:** Do not exceed 8.6 bar (125 psig) air supply pressure.

 **CAUTION:** The process fluid and cleaning fluids must be chemically compatible with all wetted pump components. Consult Chemical Resistance Guide.

 **CAUTION:** Thoroughly flush pumps before installing them into process lines. Clean and/or sanitize FDA- and USDA- approved pumps before using them.

 **CAUTION:** Before attempting any maintenance or repair, disconnect the compressed air line to the pump and allow all air pressure to bleed from the pump. Disconnect all intake, discharge, and air lines. Drain the pump by turning it upside down and allowing any fluid to flow into a suitable container. Be aware of any hazardous effects of contact with your process fluid.

 **CAUTION:** Before attaching the air line to the pump, blow out the air line for 10 to 20 seconds to make sure all pipeline debris is clear. Use an in-line air filter. A 5µ (micron) air filter is recommended.

 **CAUTION:** Pro-Flo pumps cannot be used in submersible applications.

 **CAUTION:** Before installation, tighten all hardware.

 **NOTE:** Materials of construction and elastomer material may influence suction lift parameters. Please refer to "Performance" for specifics.

 **NOTE:** When installing PTFE diaphragms, it is important to tighten outer pistons simultaneously (turning in opposite directions) to ensure tight fit. (See "Maximum Torque Specification").

 **NOTE:** Some PTFE-fitted pumps come standard from the factory with expanded PTFE gaskets installed in the diaphragm bead of the liquid chamber. PTFE gaskets cannot be re-used.

 **NOTE:** In the event of a power failure, close the shut-off valve if you do not want the pump to restart when the power returns.

 **NOTE:** The Safety Supplement document is a part of the manual. Please refer to the Safety Supplement document for a complete list of safety considerations including considerations for safe operation and maintenance of pumps marked for ATEX environments before starting the pump.

 **WARNING:** This product can expose you to chemicals including Nickel, Chromium, Cadmium, or Cobalt, which are known to the State of California to cause cancer and/or birth defects or other reproductive harm. For more information, go to www.P65Warnings.ca.gov.

SECTION 2

WILDEN PUMP DESIGNATION SYSTEM

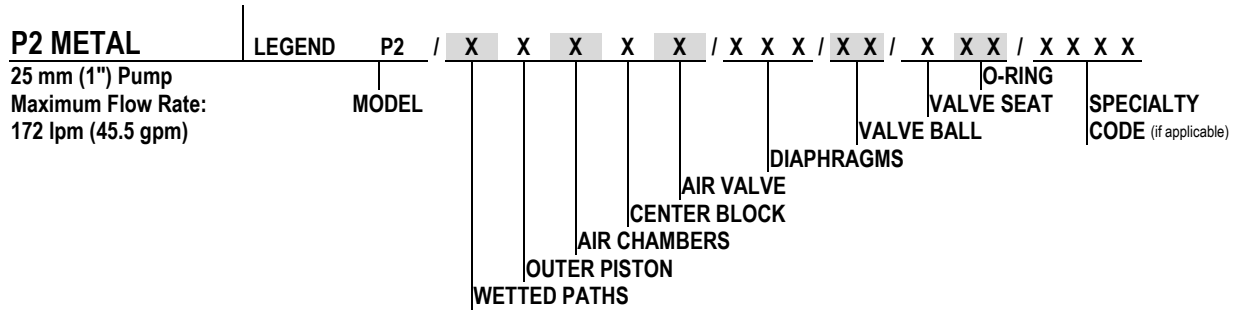

MATERIAL CODES

MODEL P2 = PRO-FLO® XP2 = PRO-FLO® ATEX	AIR VALVE J = CONDUCTIVE POLYPROPYLENE P = POLYPROPYLENE L = ACETAL	VALVE BALLS BN = BUNA-N (RED DOT) EP = EPDM (BLUE DOT) FS = SANIFLEX™ (Cream) ^{1,3} NE = NEOPRENE (GREEN DOT) TF = PTFE (WHITE) VT = FKM (SILVER OR WHITE DOT) WF = WIL-FLEX® [SANTOPRENE® (THREE BLACK DOTS)]
WETTED PATH A = ALUMINUM S = STAINLESS STEEL	DIAPHRAGMS BNS = BUNA-N (RED DOT) EPS = EPDM (BLUE DOT) FES = SANITARY EPDM ^{1,3} (TWO BLUE DOTS) FSS = SANIFLEX™ [HYTREL® (CREAM)] ^{1,3} FWS = SANITARY WIL-FLEX® ^{1,3} FWL = FULL-STROKE SANITARY WIL-FLEX®, IPD LEL = PTFE – EPDM LAMINATE IPD ^{1,2,3} NES = NEOPRENE (GREEN DOT) SSL = FULL-STROKE SANIFLEX™ IPD [HYTREL® (CREAM)] TEU = PTFE W/EPDM BACKUP (WHITE) TNU = PTFE W/NEOPRENE BACKUP (WHITE) TSS = FULL-STROKE PTFE W/SANIFLEX™ BACK-UP TSU = PTFE W/SANIFLEX™ BACK-UP (WHITE) TWS = FULL-STROKE PTFE W/WIL-FLEX® BACK-UP VTS = FKM (WHITE DOT) WFS = WIL-FLEX® [SANTOPRENE® (THREE BLACK DOTS)]	VALVE SEATS A = ALUMINUM S = STAINLESS STEEL
OUTER PISTON A = ALUMINUM S = STAINLESS STEEL Z = NO OUTER PISTON		VALVE SEATS & MANIFOLD O-RING BN = BUNA-N EP = EPDM FS = SANIFLEX™ [HYTREL® (CREAM)] ^{1,3} NE = NEOPRENE TF = PTFE (WHITE) WF = WIL-FLEX® [SANTOPRENE®]
CENTER BLOCK JJ = CONDUCTIVE POLYPROPYLENE PP = POLYPROPYLENE LL = ACETAL		

REFERENCES:

¹ Meets Requirements of FDA CFR21.177
² Meets Requirements of USP Class VI
³ Meets Requirements of 1935/2004/EC

SPECIALTY CODES

2000 NPT threaded	2080 Tri-clamp fittings only	2483 Pump Cycle Monitor (module, sensor & wires)
2014 BSPT threaded	2100 Wil-Gard 110V	2070E Saniflo™ FDA (1935/2004/EC)
2023 Wing Nuts	2102 Wil-Gard sensor wires ONLY	
2070 Saniflo™ FDA	2103 Wil-Gard 220V	
2079 Tri-clamp fittings, wing nuts	2480 Pump Cycle Monitor (sensor & wires)	

! NOTE: Most elastomeric materials use colored dots for identification. **! NOTE:** Not all models are available with all material options

SECTION 3

HOW IT WORKS – AIR-OPERATED DOUBLE-DIAPHRAGM PUMP

The Wilden diaphragm pump is an air-operated, positive displacement, self-priming pump. These drawings show flow pattern through the pump upon its initial stroke. It is assumed the pump has no fluid in it prior to its initial stroke.

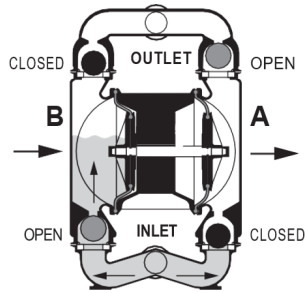

FIGURE 1 The air valve directs pressurized air to the back side of diaphragm A. The compressed air is applied directly to the liquid column separated by elastomeric diaphragms. The diaphragm acts as a separation membrane between the compressed air and liquid; a balanced load removes mechanical stress from the diaphragm. The compressed air moves the diaphragm away from the center of the pump. The opposite diaphragm is pulled in by the shaft connected to the pressurized diaphragm. Diaphragm B is on its suction stroke; air behind the diaphragm has been forced out to atmosphere through the exhaust port of the pump. The movement of diaphragm B toward the center of the pump creates a vacuum within chamber B. Atmospheric pressure forces fluid into the inlet manifold forcing the inlet valve ball off its seat. Liquid is free to move past the inlet valve ball and fill the liquid chamber (see shaded area).

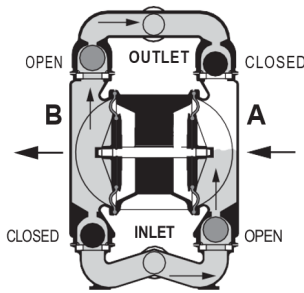

FIGURE 2 When the pressurized diaphragm, diaphragm A, reaches the limit of its discharge stroke, the air valve redirects pressurized air to the back side of diaphragm B. The pressurized air forces diaphragm B away from the center while pulling diaphragm A to the center. Diaphragm B is now on its discharge stroke. Diaphragm B forces the inlet valve ball onto its seat due to the hydraulic forces developed in the liquid chamber and manifold of the pump. These same hydraulic forces lift the discharge valve ball off its seat, while the opposite discharge valve ball is forced onto its seat, forcing fluid to flow through the pump discharge. The movement of diaphragm A toward the center of the pump creates a vacuum within liquid chamber A. Atmospheric pressure forces fluid into the inlet manifold of the pump. The inlet valve ball is forced off its seat allowing the fluid being pumped to fill the liquid chamber.

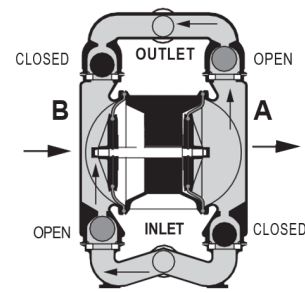
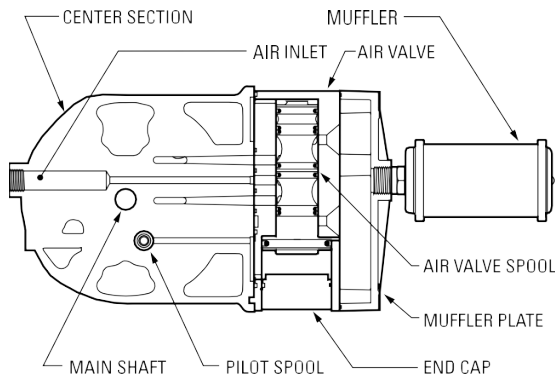

FIGURE 3 At completion of the stroke, the air valve again redirects air to the back side of diaphragm A, which starts diaphragm B on its exhaust stroke. As the pump reaches its original starting point, each diaphragm has gone through one exhaust and one discharge stroke. This constitutes one complete pumping cycle. The pump may take several cycles to completely prime depending on the conditions of the application.

HOW IT WORKS – AIR DISTRIBUTION SYSTEM



The Pro-Flo® patented air distribution system incorporates two moving parts: the air valve spool and the pilot spool. The heart of the system is the air valve spool and air valve. This valve design incorporates an unbalanced spool. The smaller end of the spool is pressurized continuously, while the large end is alternately pressurized then exhausted to move the spool. The spool directs pressurized air to one air chamber while exhausting the other. The air causes the main shaft/diaphragm assembly to shift to one side — discharging liquid on that side and pulling liquid in on the other side. When the shaft reaches the end of its stroke, the inner piston actuates the pilot spool, which pressurizes and exhausts the large end of the air valve spool. The repositioning of the air valve spool routes the air to the other air chamber

SECTION 4

DIMENSIONAL DRAWING

P2 Metal

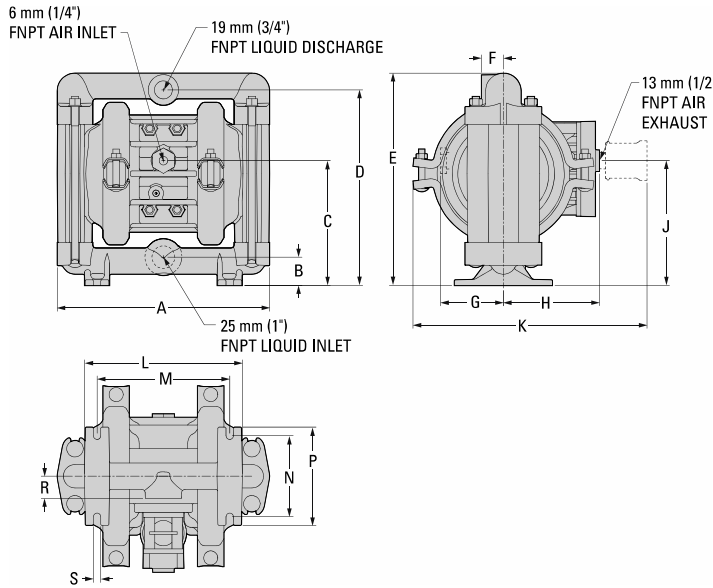

DIMENSIONS

ITEM	METRIC (mm)	STANDARD (inch)
A	274	10.8
B	38	1.5
C	163	6.4
D	254	10.0
E	274	10.8
F	28	1.1
G	81	3.2
H	124	4.9
J	163	6.4
K	302	11.9
L	203	8.0
M	173	6.8
N	104	4.1
P	127	5.0
R	28	1.1
S	10	0.4

LW0399 REV. A

P2 Metal Saniflo™ FDA

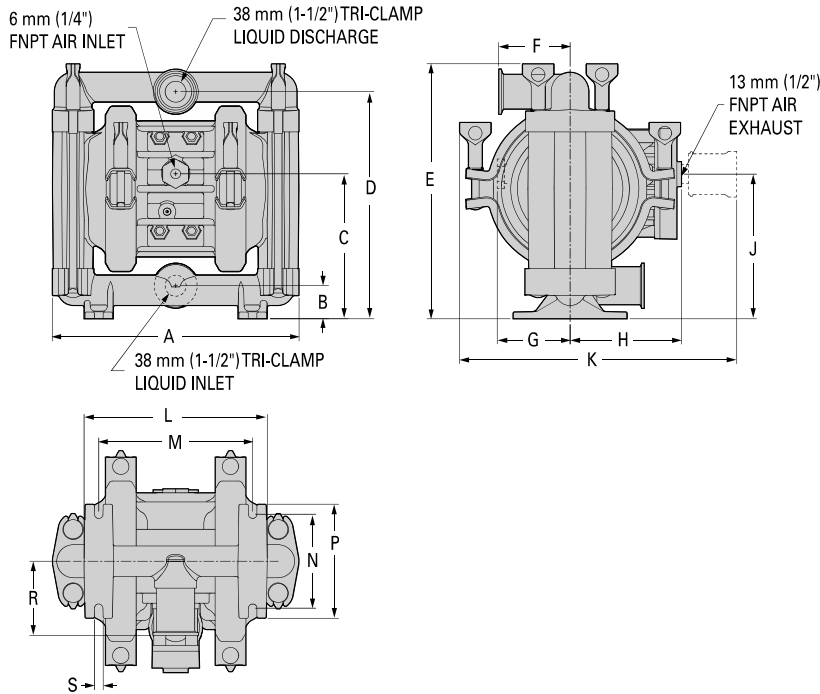

DIMENSIONS

ITEM	METRIC (mm)	STANDARD (inch)
A	274	10.8
B	38	1.5
C	163	6.4
D	254	10.0
E	284	11.2
F	79	3.1
G	81	3.2
H	124	4.9
J	160	6.3
K	310	12.2
L	203	8.0
M	173	6.8
N	104	4.1
P	127	5.0
R	84	3.3
S	10	0.4

LW0400 REV. A

SECTION 5

PERFORMANCE

P2 METAL RUBBER-FITTED

Ship Weights.....Aluminum 9 kg (20 lb)
Stainless Steel 17 kg (37 lb)
Air Inlet......6 mm (1/4")
Inlet......25 mm (1")
Outlet......19 mm (3/4")
Suction Lift......5.2 m Dry (17.0')
9.0 m Wet (29.5')
Disp. per Stroke¹......0.3 L (0.08 gal)
Max. Flow Rate......172 lpm (45.5 gpm)
Max. Size Solids......3.2 mm (1/8")

¹Displacement per stroke was calculated at 4.8 bar (70 psig) air inlet pressure against a 2.1 bar (30 psig) head pressure.

Example: To pump 95 lpm (25 gpm) against a discharge head of 5.2 bar (75 psig) requires 6.9 bar (100 psig) and 68 Nm³/h (40 scfm) air consumption.

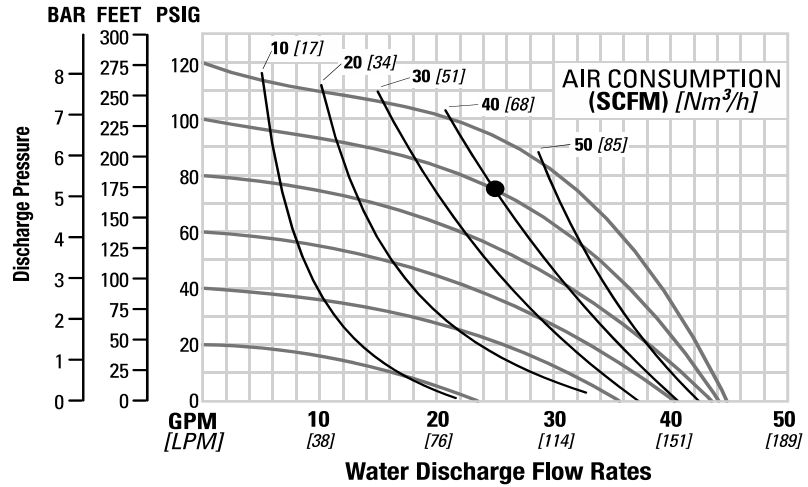

Flow rates indicated on chart were determined by pumping water. For optimum life and performance, pumps should be specified so that daily operation parameters will fall in the center of the pump's performance curve.

Caution: Do not exceed 8.6 bar (125 psig) air supply pressure.

P2 METAL TPE-FITTED

Ship Weights.....Aluminum 9 kg (20 lb)
Stainless Steel 17 kg (37 lb)
Air Inlet......6 mm (1/4")
Inlet......25 mm (1")
Outlet......19 mm (3/4")
Suction Lift......7.6 m Dry (25.0')
9.0 m Wet (29.5')
Disp. per Stroke¹......0.3 L (0.08 gal)
Max. Flow Rate......171 lpm (45.2 gpm)
Max. Size Solids......3.2 mm (1/8")

¹Displacement per stroke was calculated at 4.8 bar (70 psig) air inlet pressure against a 2.1 bar (30 psig) head pressure.

Example: To pump 61 lpm (16 gpm) against a discharge head of 6.6 bar (96 psig) requires 6.9 bar (100 psig) and 51 Nm³/h (30 scfm) air consumption.

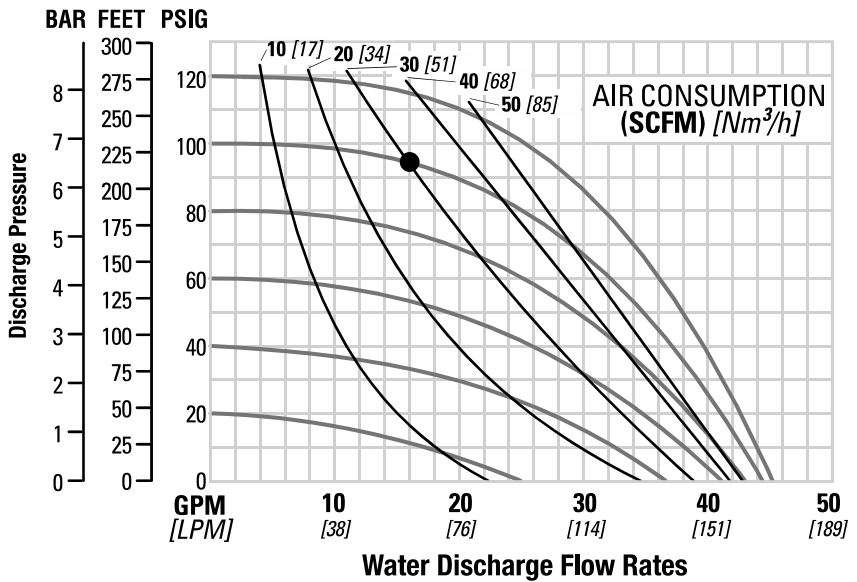

Flow rates indicated on chart were determined by pumping water. For optimum life and performance, pumps should be specified so that daily operation parameters will fall in the center of the pump's performance curve.

Caution: Do not exceed 8.6 bar (125 psig) air supply pressure.

PERFORMANCE

**P2 METAL
REDUCED-STROKE
PTFE-FITTED**

Ship Weights.....Aluminum 9 kg (20 lb)
 Stainless Steel 17 kg (37 lb)
Air Inlet.....6 mm (1/4")
Inlet.....25 mm (1")
Outlet.....19 mm (3/4")
Suction Lift.....2.8 m Dry (9.1')
 9.0 m Wet (29.5')
Disp. per Stroke¹.....0.3 L (0.08 gal)
Max. Flow Rate.....155 lpm (41.0 gpm)
Max. Size Solids.....3.2 mm (1/8")

¹Displacement per stroke was calculated at 4.8 bar (70 psig) air inlet pressure against a 2.1 bar (30 psig) head pressure.

Example: To pump 45 lpm (12 gpm) against a discharge head of 6.2 bar (90 psig) requires 6.9 bar (100 psig) and 51 Nm³/h (30 scfm) air consumption.

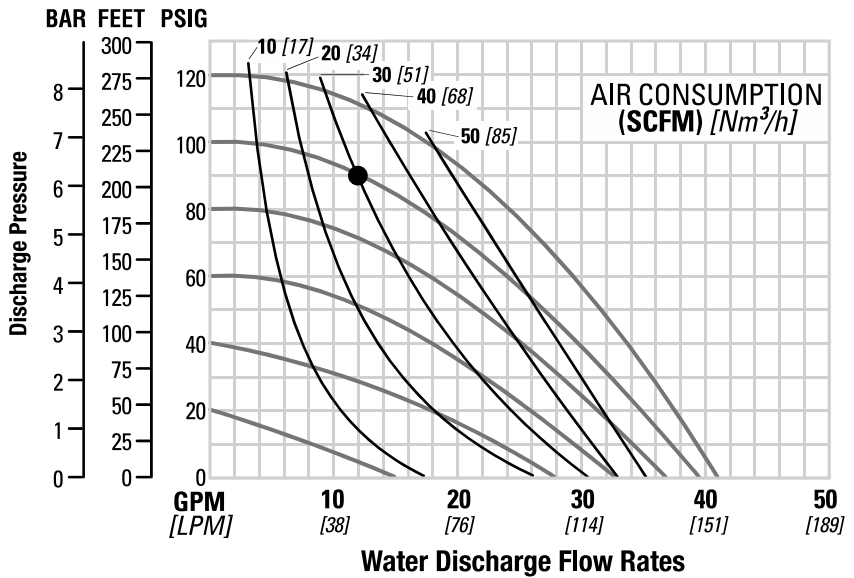

Flow rates indicated on chart were determined by pumping water. For optimum life and performance, pumps should be specified so that daily operation parameters will fall in the center of the pump's performance curve.

Caution: Do not exceed 8.6 bar (125 psig) air supply pressure.

**P2 METAL
FULL-STROKE
PTFE-FITTED**

Ship Weights.....Aluminum 9 kg (20 lb)
 Stainless Steel 17 kg (37 lb)
Air Inlet.....6 mm (1/4")
Inlet.....25 mm (1")
Outlet.....19 mm (3/4")
Suction Lift.....4.7 m Dry (15.3')
 9.0 m Wet (29.5')
Disp. per Stroke¹.....0.3 L (0.08 gal)
Max. Flow Rate.....167 lpm (44.1 gpm)
Max. Size Solids.....3.2 mm (1/8")

¹Displacement per stroke was calculated at 4.8 bar (70 psig) air inlet pressure against a 2.1 bar (30 psig) head pressure.

Example: To pump 53 lpm (14 gpm) against a discharge head of 5.0 bar (72 psig) requires 5.5 bar (80 psig) and 34 Nm³/h (20 scfm) air consumption.

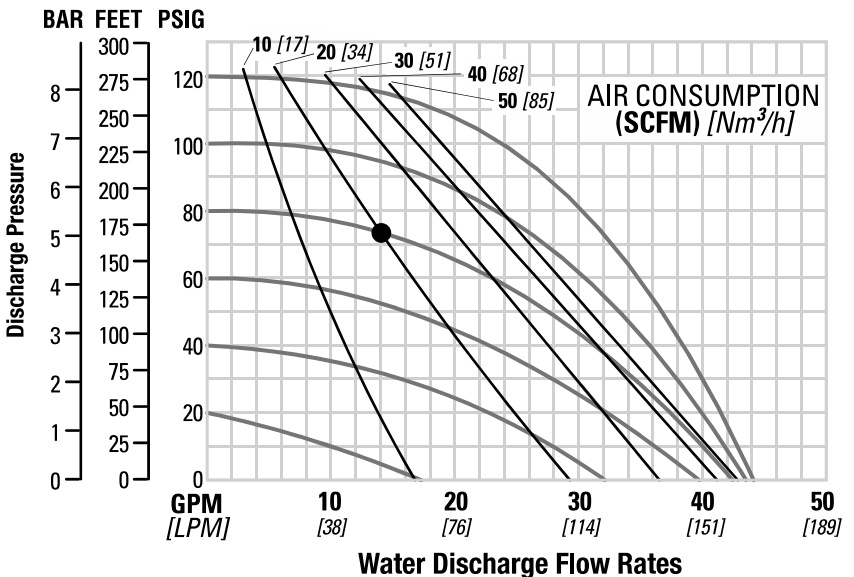

Flow rates indicated on chart were determined by pumping water. For optimum life and performance, pumps should be specified so that daily operation parameters will fall in the center of the pump's performance curve.

Caution: Do not exceed 8.6 bar (125 psig) air supply pressure.

SECTION 5

SUCTION LIFT CAPABILITY

P2 METAL SUCTION-LIFT CAPABILITY

Suction-lift curves are calibrated for pumps operating at 305 m (1,000') above sea level. This chart is meant to be a guide only. There are many variables that can affect your pump's operating characteristics. The number of intake and discharge elbows, viscosity of pumping fluid, elevation (atmospheric pressure) and pipe friction loss all affect the amount of suction lift your pump will attain.

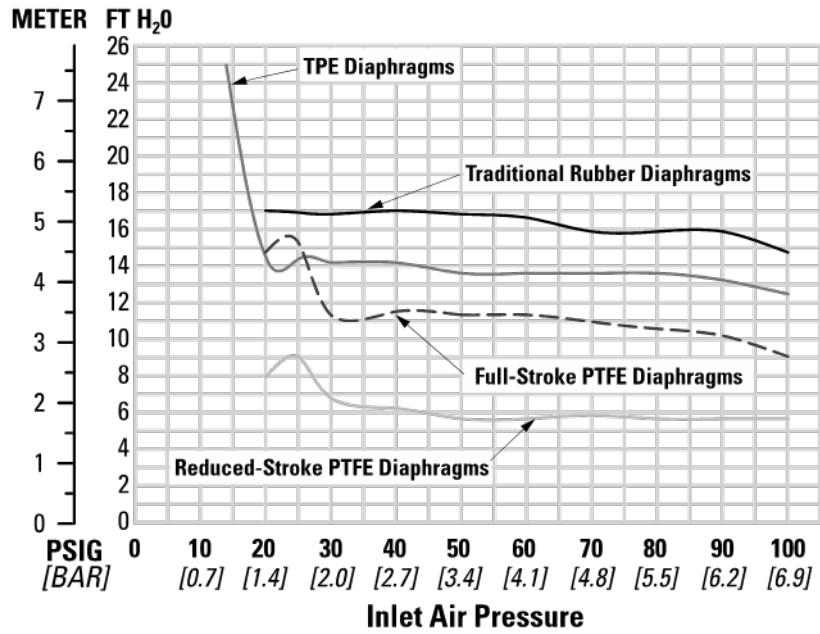

SECTION 6

**SUGGESTED INSTALLATION, OPERATION, MAINTENANCE
AND TROUBLESHOOTING**

Wilden pumps are designed to meet the performance requirements of even the most demanding pumping applications. They have been designed and manufactured to the highest standards and are available in a variety of liquid path materials to meet your chemical resistance needs. Refer to "Performance" for an in-depth analysis of the performance characteristics of your pump. Wilden offers the widest variety of elastomer options in the industry to satisfy temperature, chemical compatibility, abrasion resistance and flex concerns.

The suction pipe size should be at least equal to or larger than the diameter size of the suction inlet on your Wilden pump. The suction hose must be a non-collapsible, reinforced type because these pumps are capable of pulling a high vacuum. Discharge piping should also be equal to or larger than the diameter of the pump discharge, which will help reduce friction losses.

⚠ CAUTION: All fittings and connections must be airtight. Otherwise, pump suction capability will be reduced or lost.

Months of careful planning, study and selection efforts can result in unsatisfactory pump performance if installation details are left to chance. You can avoid premature failure and long-term dissatisfaction by exercising reasonable care throughout the installation process.

Location

Noise, safety and other logistical factors usually dictate where equipment will be situated on the production floor. Multiple installations with conflicting requirements can result in congestion of utility areas, leaving few choices for additional pumps. Within the framework of these and other existing conditions, locate every pump in such a way that the following six key factors are balanced against each other to maximum advantage:

- **Access:** First, the location should be accessible. If it's easy to reach the pump, maintenance personnel will be able to perform routine inspections and adjustments more easily. If major repairs become necessary, ease of access can play a key role in speeding the repair process and reducing total downtime.
- **Air Supply:** Every pump location should have an air line large enough to supply the volume of air necessary to achieve the desired pumping rate. For best results, the pumps should use a 5µ (micron) air filter, needle valve and regulator. The use of an air filter before the pump will ensure that the majority of any pipeline contaminants will be eliminated.
- **Solenoid Operation:** When operation is controlled by a solenoid valve in the air line, three-way valves should be used. This valve allows trapped air between the valve and the pump to bleed off, which improves pump performance. You can estimate pumping volume by counting the number of strokes per minute, and then multiplying that figure by the displacement per stroke.
- **Muffler:** Using the standard Wilden muffler, sound levels are reduced below OSHA specifications. You can use other mufflers to reduce sound levels farther, but they usually reduce pump performance.
- **Elevation:** Selecting a site that is well within the pump's dynamic lift capability will assure that loss-of-prime issues will

be eliminated. In addition, pump efficiency can be adversely affected if proper attention is not given to site location.

- **Piping:** Final determination of the pump site should not be made until the piping challenges of each possible location have been evaluated. The impact of current and future installations should be considered ahead of time to make sure that inadvertent restrictions are not created for any remaining sites.

The best choice possible will be a site involving the shortest and straightest hook-up of suction and discharge piping. Unnecessary elbows, bends and fittings should be avoided. Pipe sizes should be selected to keep friction losses within practical limits. All piping should be supported independently of the pump. In addition, the piping should be aligned to avoid placing stress on the pump fittings.

Flexible hose can be installed to aid in absorbing the forces created by the natural reciprocating action of the pump. If the pump is to be bolted down to a solid location, a mounting pad placed between the pump and the foundation will assist in minimizing pump vibration. Flexible connections between the pump and rigid piping will also assist in minimizing pump vibration. If quick-closing valves are installed at any point in the discharge system, or if pulsation within a system becomes a problem, a surge suppressor (SD Equalizer) should be installed to protect the pump, piping and gauges from surges and water hammer.

If the pump is to be used in a self-priming application, make sure that all connections are airtight and that the suction lift is within the model's ability.

! NOTE: Materials of construction and elastomer material have an effect on suction lift parameters. Please refer to "Performance" for specifics.

When pumps are installed in applications involving flooded suction or suction head pressures, a gate valve should be installed in the suction line to permit closing of the line for pump service.

Pumps in service with a positive suction head are most efficient when inlet pressure is limited to 0.5–0.7 bar (7–10 psig). Premature diaphragm failure may occur if positive suction is 0.7 bar (10 psig) and higher.

⚠ CAUTION: All Wilden pumps are capable of passing solids. Use a strainer on the pump intake to ensure that the pump's rated solids capacity is not exceeded.

⚠ CAUTION: Do not exceed 8.6 bar (125 psig) air supply pressure.

⚠ CAUTION: Pro-Flo® and Accu-Flo™ pumps do not have single-point exhaust option and are not submersible.

SUGGESTED INSTALLATION, OPERATION, MAINTENANCE AND TROUBLESHOOTING

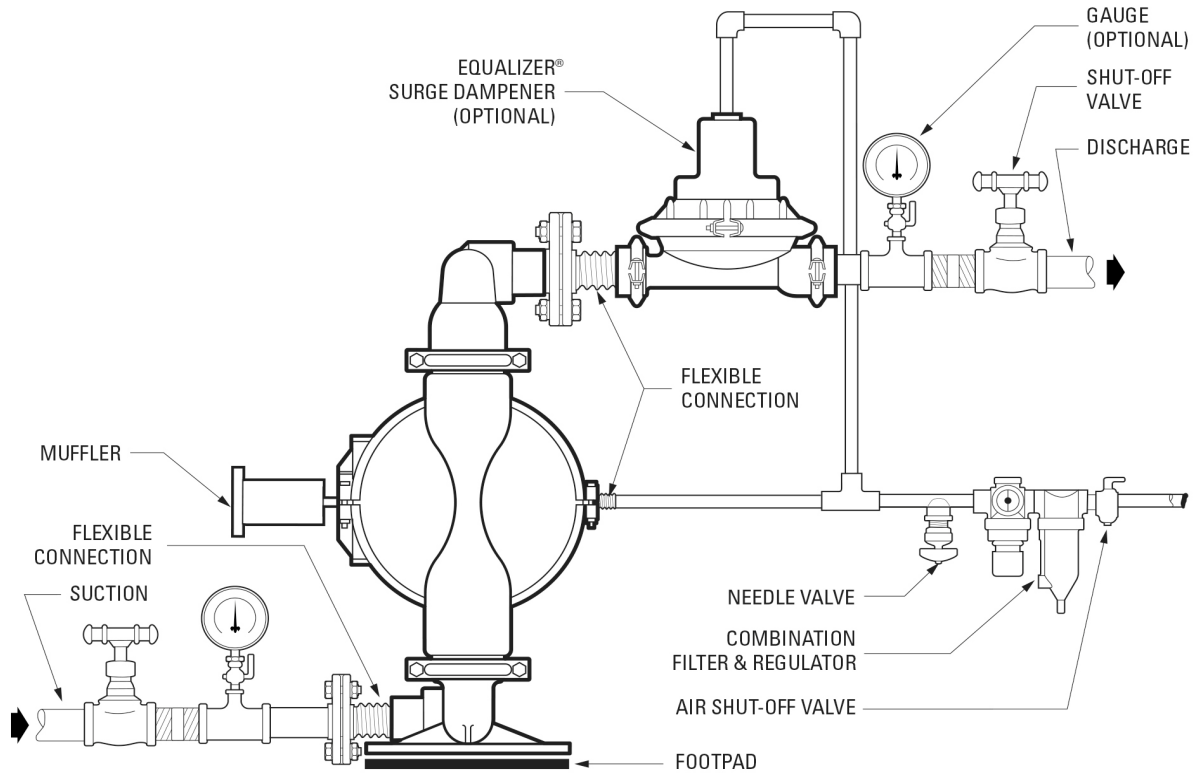

! **NOTE:** In the event of a power failure, close the shut-off valve if you do not want the pump to restart when the power returns.

Air-Operated Pumps: To stop the pump from operating in an emergency, simply close the shut-off valve (user-supplied) installed in the air supply line. A properly functioning valve will stop the air supply to the pump, therefore stopping output. This shut-off valve should be located far enough away from the pumping equipment such that it can be reached safely in an emergency.

Operation

The Pro-Flo pumps are pre-lubricated and do not require in-line lubrication. Additional lubrication will not damage the pump. However, if the pump is heavily lubricated by an external source, the pump's internal lubrication maybe washed away. If the pump is then moved to a nonlubricated location, it may need to be disassembled and re-lubricated as described in "Disassembly/ Reassembly".

Pump discharge rate can be controlled by limiting the volume and/or pressure of the air supply to the pump. An air regulator is used to regulate air pressure. A needle valve is used to regulate volume. Pump discharge rate also can be controlled by throttling the pump discharge by partially closing a valve in the discharge line of the pump. This action increases friction loss, which reduces flow rate. (See "Performance") This is useful when the need exists

to control the pump from a remote location. When the pump discharge pressure equals or exceeds the air supply pressure, the pump will stop. No bypass or pressure relief valve is needed, and pump damage will not occur. The pump has reached a "deadhead" situation and can be restarted by reducing the fluid discharge pressure or increasing the air inlet pressure. Wilden Pro-Flo pumps run solely on compressed air and do not generate heat. Therefore, your process fluid temperature will not be affected.

Maintenance and Inspections

Because each application is unique, maintenance schedules maybe different for every pump. Frequency of use, line pressure, viscosity and abrasiveness of process fluid all affect the parts life of a Wilden pump. Periodic inspections have been found to offer the best means for preventing unscheduled pump downtime. Personnel familiar with the pump's construction and service should be informed of any abnormalities that are detected during operation.

SUGGESTED INSTALLATION, OPERATION, MAINTENANCE AND TROUBLESHOOTING

Troubleshooting

Pump will not run or runs slowly.

1. Remove plug from pilot spool exhaust.
2. Ensure that the air inlet pressure is at least 0.4 bar (5 psig) above startup pressure and that the differential pressure (the difference between air inlet and liquid discharge pressures) is not less than 0.7 bar (10 psig).
3. Check air inlet filter for debris (see "Suggested Installation, Operation, Maintenance and Troubleshooting").
4. Check for extreme air leakage (blow by) that would indicate worn seals/bores in the air valve, pilot spool and main shaft.
5. Disassemble the pump and check for obstructions in the air passageways or objects that would obstruct the movement of internal parts.
6. Check for sticking ball check valves.
 - a. If material being pumped is not compatible with pump elastomers, swelling may occur. Replace ball check valves and seals with proper elastomers.
 - b. Also, as the check valve balls wear out, they become smaller and can become stuck in the seats. In this case, replace balls and seats.
7. Check for any broken inner piston that would cause the air valve spool to be unable to shift.

Pump runs, but little or no product flows.

1. Check for pump cavitation. Slow pump speed down to allow thick material to flow into liquid chambers.
2. Verify that vacuum required to lift liquid is not greater than the vapor pressure of the material being pumped (cavitation).
3. Check for sticking ball check valves.
 - a. If material being pumped is not compatible with pump elastomers, swelling may occur. Replace ball check valves and seals with proper elastomers.
 - b. Also, as the check valve balls wear out, they become smaller and can become stuck in the seats. In this case, replace balls and seats.

Pump air valve freezes.

1. Check for excessive moisture in the compressed air.
 - a. Either install a dryer or a hot air generator for compressed air.
 - b. Alternatively, you may use coalescing filter to remove the water from the compressed air in some applications.

Air bubbles in pump discharge.

1. Check for a ruptured diaphragm.
2. Check tightness of outer pistons (see "Disassembly/Reassembly").
3. Check tightness of fasteners and integrity of O-rings and seals, especially at intake manifold.
4. Ensure pipe connections are airtight.

Product comes out air exhaust.

1. Check for a diaphragm rupture.
2. Check the tightness of the outer pistons to the shaft.

SECTION 7

DISASSEMBLY / REASSEMBLY

PUMP DISASSEMBLY

Tools Required:

- 1/2" Box Wrench
- 9/16" Wrench
- Adjustable Wrench
- Vise equipped with soft jaws (such as plywood, plastic or other suitable material)



CAUTION: Before attempting any maintenance or repair, disconnect the compressed air line to the pump and allow all air pressure to bleed from the pump. Disconnect all intake, discharge, and air lines. Drain the pump by turning it upside down and allowing any fluid to flow into a suitable container. Be aware of any hazardous effects of contact with your process fluid.



NOTE: Your specific pump model may vary from the configuration shown; however, pump disassembly procedure will be the same.



NOTE: The model used for these instructions incorporates rubber diaphragms and balls. Models with PTFE diaphragms and balls are the same except where noted.



NOTE: Replace worn parts with genuine Wilden parts for reliable performance.

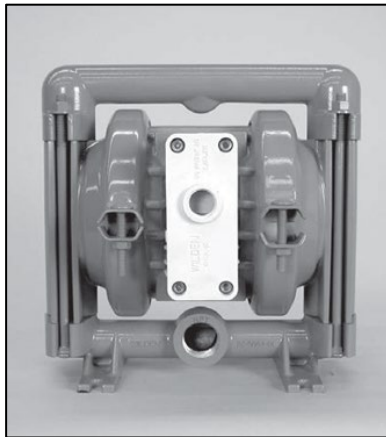

Step 1

Prior to disassembly, alignment marks should be placed on the liquid chambers and air chamber to assist with proper alignment during reassembly.



Step 2

Using a 9/16" box wrench, remove the nuts that connect the inlet and discharge manifolds to the center section assembly.

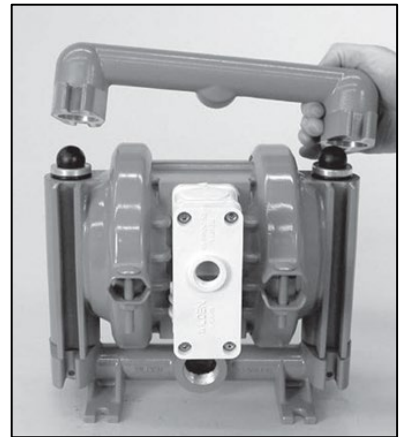

Step 3

Next, remove the discharge manifold from the pump.

DISASSEMBLY / REASSEMBLY



Step 4

Remove the discharge valve ball, valve seat and valve seat O-ring and inspect for signs of wear and replace, if necessary.

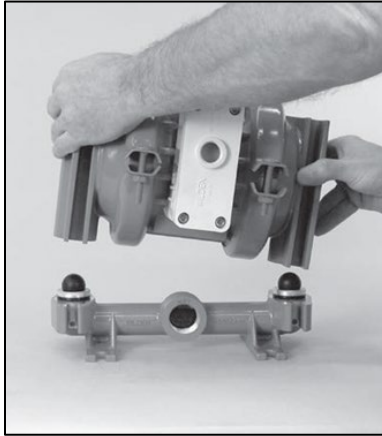

Step 5

Now the center section assembly can be removed from the inlet manifold.

NOTE: Inverting the pump will facilitate removal of inlet manifold.



Step 6

Remove the inlet valve balls, seats and valve seat O-rings from the liquid chamber and inlet manifold, inspect for nicks, gouges, chemical attack or abrasive wear.

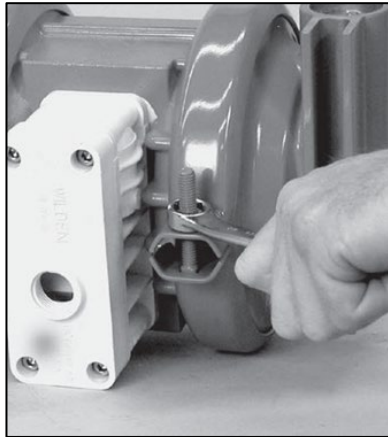

Step 7

Using a 1/2" box end wrench, remove the large clamp bands. With the clamp bands removed, lift the liquid chamber away from the center section.



Step 8

Using a 3/4" wrench or rotating the diaphragm by hand, remove the diaphragm assembly from the center section.

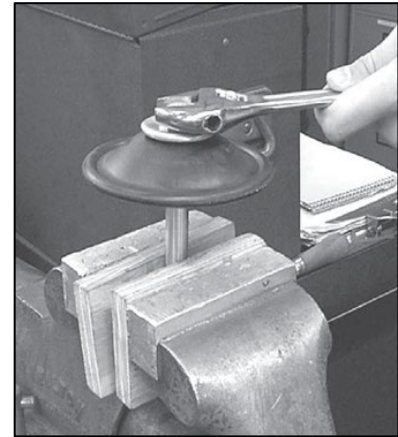

Step 9

To remove the diaphragm assembly from the shaft, secure shaft with soft jaws (a vise fitted with plywood or other suitable material) to ensure shaft is not nicked, scratched, or gouged. Using an adjustable wrench, remove the diaphragm assembly from shaft. Inspect all parts for wear and replace with genuine Wilden parts, if necessary.

DISASSEMBLY / REASSEMBLY

AIR VALVE DISASSEMBLY

Tools Required:

- 3/16" Hex Head Wrench
- 7/32" Hex Head Wrench
- Snap-Ring Pliers
- O-Ring Pick



CAUTION: Before attempting any maintenance or repair, disconnect the compressed air line to the pump and allow all air pressure to bleed from the pump. Disconnect all intake, discharge, and air lines. Drain the pump by turning it upside down and allowing any fluid to flow into a suitable container. Be aware of any hazardous effects of contact with your process fluid.



NOTE: Replace worn parts with genuine Wilden parts for reliable performance.



NOTE: For pump Air Valves fitted with Pump Cycle Monitor (PCMI) units, if the Set Screw is removed from the Air Valve Spool and/or the Sensor is removed from the Air Valve End Cap, refer to PCMI EOM WIL-19130-E for reassembly instructions.

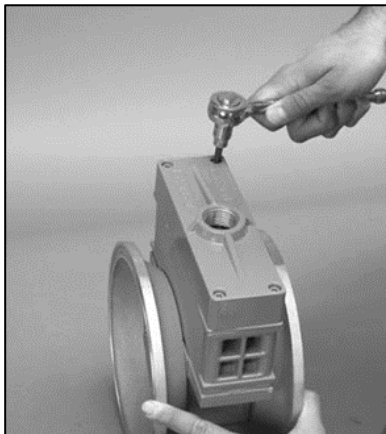

Step 1

Loosen the air valve bolts utilizing a 3/16" Hex Head wrench.

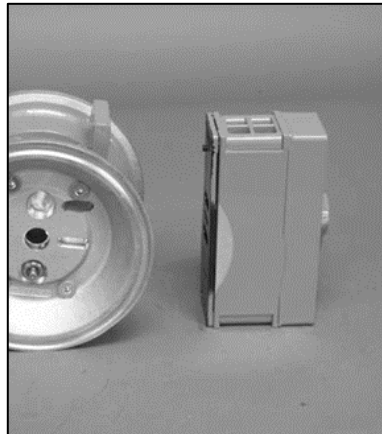

Step 2

Remove muffer plate and air valve bolts from air valve assembly exposing muffer gasket for inspection. Replace if necessary.

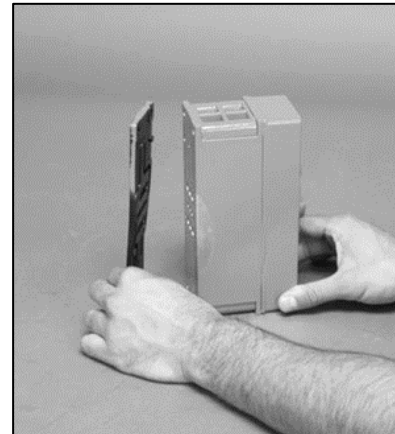

Step 3

Remove air valve end cap to expose air valve spool.

DISASSEMBLY / REASSEMBLY

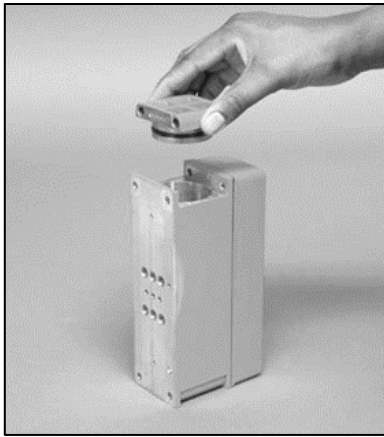

Step 4

Remove air valve spool from air valve body by threading one air valve bolt into the end of the spool and gently sliding the spool out of the air valve body. Inspect seals for signs of wear and replace entire assembly if necessary. Use caution when handling air valve spool to prevent damaging seals.

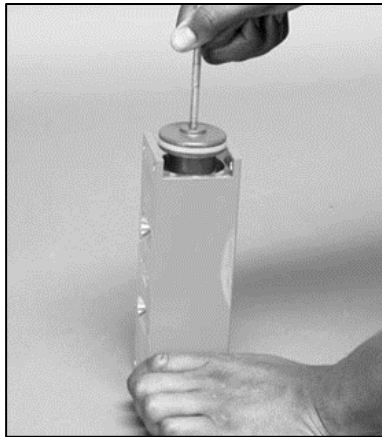

Step 5

Remove pilot spool sleeve retaining snap ring on both sides of center section with snap ring pliers.

NOTE: Seals should not be removed from assembly. Seals are not sold separately.



Step 6

Remove pilot spool assembly from center section.



Step 7

Remove air chamber bolts with 1/4" hex-head wrench.



Step 8

Remove pilot spool bushing from center block.

REASSEMBLY HINTS AND TIPS

Upon performing applicable maintenance to the air distribution system, the pump can now be reassembled. Please refer to the disassembly instructions for photos and parts placement.

To reassemble the pump, follow the disassembly instructions in reverse order. The air distribution system needs to be assembled first, then the diaphragms and finally the wetted path. The applicable torque specifications are on this page.

The following tips will assist in the assembly process:

- Clean the inside of the center section shaft bore to ensure no damage is done to new seals.
- Stainless bolts should be lubed to reduce the possibility of seizing during tightening.
- Level the water chamber side of the intake/discharge manifold to ensure a proper sealing surface. This is most easily accomplished by placing them on a flat surface prior to tightening their clamp bands to the desired torque (see below for Torque Specifications).
- Be sure to tighten outer pistons simultaneously on PTFE-fitted pumps to ensure proper torque values.
- Ensure proper mating of liquid chambers to manifolds prior to tightening vertical bolts. Overhang should be equal on both sides.
- Apply a small amount of Loctite 242 to the shaft interval threads before the diaphragm assembly.
- Concave side of disc spring in diaphragm assembly faces toward shaft.

Maximum Torque Specifications	
Description	Torque
Air Valve, Pro-Flo [®]	3.1 N·m (27 in-lb)
Air Inlet, Reducer Bushing	10.9 N·m (8 in-lb)
Outer Piston, Rubber and PTFE-fitted	40.7 N·m (30 ft-lb)
Vertical Bolts	31.1 N·m (23 ft-lb)

DISASSEMBLY / REASSEMBLY

SHAFT SEAL INSTALLATION

Pre-Installation

After all the old seals have been removed, the inside of the bushing should be cleaned to ensure no debris is left that may cause premature damage to the new seals.

Installation

1. To prevent damaging the inside surface of the new seal, wrap electrical tape around each leg of the needle-nose pliers. (Heat shrink tubing may also be used.)
2. With a new seal in hand, place the two legs of the needle-nose pliers inside the seal ring. (See Figure A.)
3. Open the pliers as wide as the seal diameter will allow, then with two fingers pull down on the top portion of the seal to form a kidney bean shape. (See Figure B.)
4. Lightly clamp the pliers together to hold the seal into the kidney shape. Be sure to pull the seal into as tight of a kidney shape as possible. This will allow the seal to travel down the bushing bore with greater ease.
5. With the seal clamped in the pliers, insert the seal into the bushing bore and position the bottom of the seal into the correct groove. When the bottom of the seal is seated in the groove, release the clamp pressure on the pliers. This will allow the seal to partially snap back to its original shape.
6. After removing the pliers, you will notice a slight bump in the seal shape. Before the seal can be resized properly, the bump in the seal should be removed as much as possible. This can be done with either a Phillips screwdriver or your finger. With the side of the screwdriver or your finger, apply light pressure to the peak of the bump. This pressure will cause the bump to be eliminated almost completely.
7. Lubricate the edge of the shaft with NLGI grade 2 white EP bearing grease.
8. Slowly insert the center shaft with a rotating motion. This will complete the resizing of the seal.
9. Repeat these steps for the remaining seals.

Tools

The following tools can be used to aid in the installation of the new seals:

- Needle-Nose Pliers
- Phillips Screwdriver
- Electrical Tape

Figure A

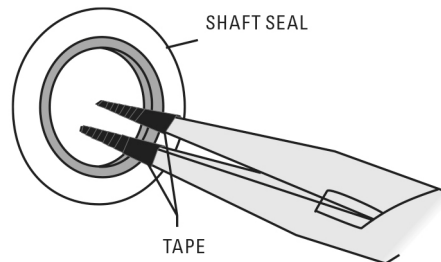
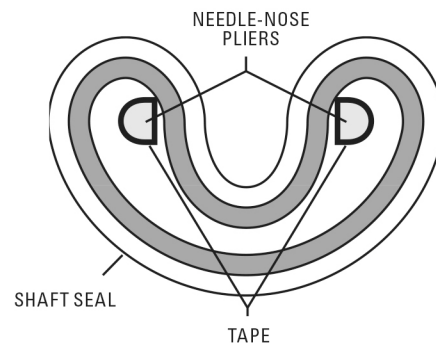

Figure B



SECTION 8

EXPLODED VIEW AND PARTS LIST

P2 METAL – RUBBER/TPE-FITTED

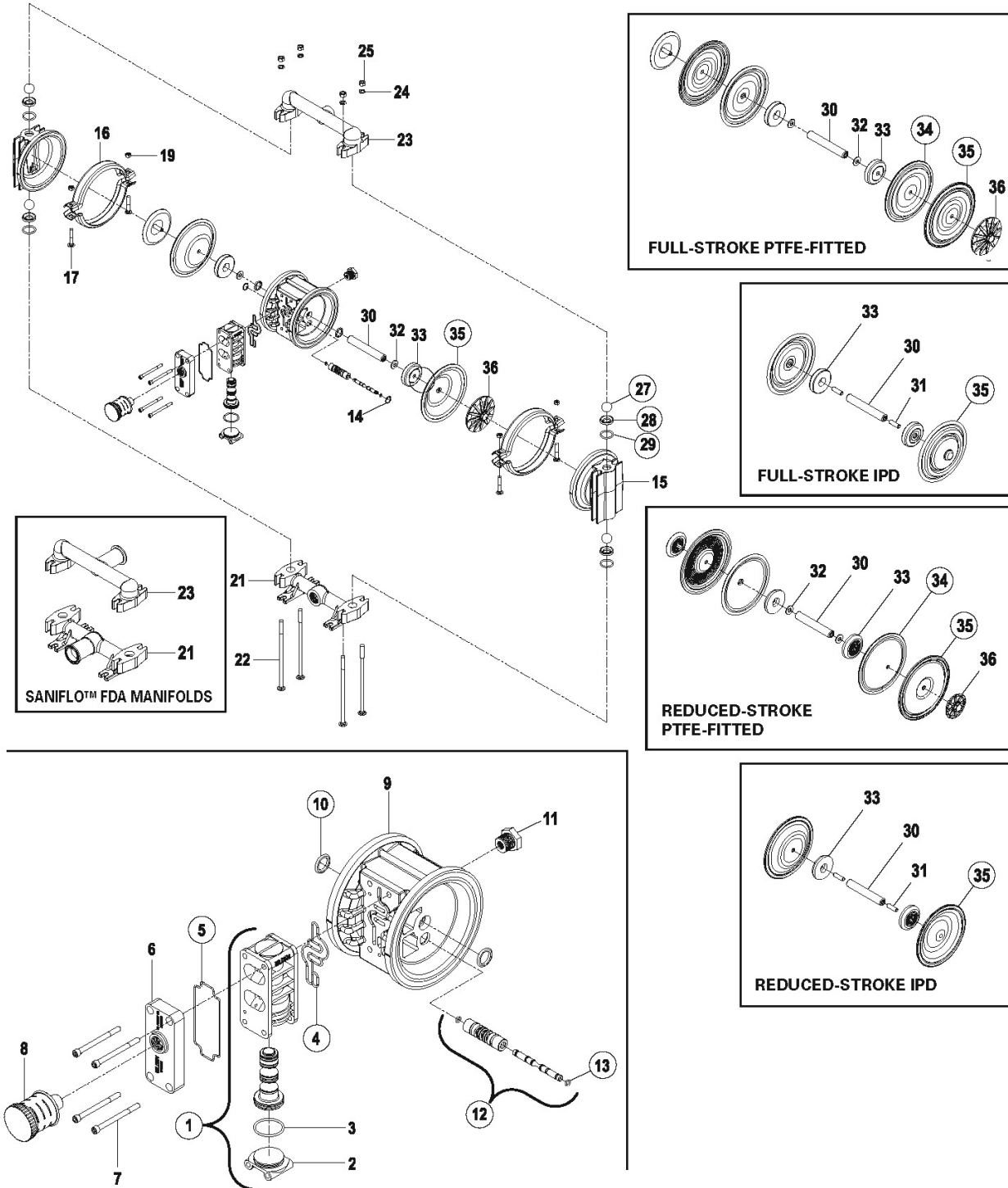

ALL CIRCLED PART IDENTIFIERS ARE INCLUDED IN REPAIR KITS

EXPLODED VIEW AND PARTS LIST

Item	Description	Qty	P2/AXPPP P/N	P2/SXPPP P/N	P2/SXPPP/2070 P/N	P2/AXLLL P/N	P2/SXLLL P/N	P2/SXLLL/2070 P/N
AIR DISTRIBUTION COMPONENTS								
1	Air Valve, Pro-Flo™ Assembly ¹	1		01-2010-20				01-2010-13
2	End Cap, Pro-Flo™	1		01-2332-20				01-2332-13
3	O-Ring, End Cap (-126) (Æ1.362 X Æ.103)	1			01-2395-52			
4	Gasket, Air Valve, Pro-Flo™	1			01-2615-52			
5	Gasket, Muffler Plate, Pro-Flo™	1			01-3505-52			
6	Muffler Plate, Pro-Flo™	1		01-3181-20				01-3181-13
7	Screw, SHC, 1/4"-20 X 3"	4			01-6001-03			
8	Muffler	1			02-3510-99			
9	Center Section Assembly, Pro-Flo™ ²	1		02-3145-20				02-3145-13
10	Shaft Seal	2			02-3210-55-225			
11	Bushing, Reducer	1		01-6950-20				01-6950-13
12	Pilot Sleeve Assembly	1			02-3880-99			
13	Pilot Spool Retaining O-Ring	2			04-2650-49-700			
14	Retaining Ring	2			00-2650-03			
WETTED PATH COMPONENTS								
15	Chamber, Liquid	2	02-5004-01	02-5004-03	02-5004-03P	02-5004-01	02-5004-03	02-5004-03P
16	Clamp Band Assy. Large ^{3,4}	2	02-7300-08-400		02-7300-03-400	02-7300-08-400		02-7300-03-400
17	Bolt, RHSN, 5/16"-18 X 2"	4	08-6050-08-50		08-6050-03-500	08-6050-08-50		08-6050-03-500
18	Washer, (.344 I.D. X .688 O.D. X .065 THK) (not shown)	4			02-6731-03			02-6731-03
19	Nut, Hex, 5/16"-18	4	04-6420-08	08-6400-03		04-6420-08	08-6400-03	
20	Wing Nut, 5/16"-18 (not shown)	4			08-6661-10			08-6661-10
21	Manifold, Inlet (NPT)	1	02-5084-01	02-5084-03		02-5084-01	02-5084-03	
	Manifold, Inlet (BSPT)	1	02-5086-01	02-5086-03		02-5086-01	02-5086-03	
	Manifold, Inlet (Tri-Clamp)	1			02-5088-03-70P			02-5088-03-70P
22	Bolt, RHSN, 3/8"-16 X 8 1/2"	4	02-6080-08		02-6080-03	02-6080-08		02-6080-03
23	Manifold, Discharge (NPT)	1	02-5024-01	02-5024-03		02-5024-01	02-5024-03	
	Manifold, Discharge (BSPT)	1	02-5026-01	02-5026-03		02-5026-01	02-5026-03	
	Manifold, Discharge (Tri-Clamp)	1			02-5028-03-70P			02-5028-03-70P
24	Washer, Flat (Ø.390 X Ø.625 X .063)	4	15-6720-08		02-6730-03	15-6720-08		02-6730-03
25	Nut, Hex, 3/8"-16	4	02-6430-08	02-6430-03		02-6430-08	02-6430-03	
26	Wing Nut, 3/8"-16 (not shown)	4			08-6671-10			08-6671-10
VALVE BALLS/VALVE SEATS/VALVE O-RINGS								
27	Valve Ball	4			*			
28	Valve Seat	4		*	02-1120-03P		*	02-1120-03P
29	O-Ring, Valve Seat (-216) (Ø1.109 X Ø.139)	4			*			
FULL STROKE RUBBER/TPE/PTFE/FSIPD COMPONENTS								
30	Shaft, P2 Pro-Flo™ (Non-PTFE)	1			02-3810-03			
31	Shaft Stud, 3/8"-16 X 1-1/4"	2			02-6150-03-85			02-6150-03-85
32	Spring, Disk	2			02-6802-08			
33	Piston, Inner, P2 Pro-Flo™ (Non-PTFE)	2			02-3701-01			
34	Diaphragm, Back-Up	2			*			
35	Diaphragm, Primary	2			*			
	Diaphragm, IPD, Primary	2			*			
36	Piston, Outer, (Non-PTFE)	2	02-4550-01	02-4550-03	02-4550-03P	02-4550-01	02-4550-03	02-4550-03P
REDUCED STROKE PTFE/IPD COMPONENTS								
30	Shaft, Pro-Flo™ (PTFE)	1			02-3840-03			
31	Shaft Stud, 3/8"-16 X 1-1/4"	2			02-6150-03-85			02-6150-03-85
32	Spring, Disk	2			02-6802-08			
33	Piston, Inner, P2 Pro-Flo™ (PTFE)	2			02-3751-01			
34	Diaphragm, Back-Up, Reduced Stroke PTFE	2			*			
35	Diaphragm, Primary, Reduced Stroke PTFE	2			*			
	Diaphragm, IPD Primary, Reduced Stroke PTFE	2			*			
36	Piston, Outer, (PTFE)	2	02-4601-01	02-4600-03	02-4600-03P	02-4601-01	02-4600-03	02-4600-03P

¹Refer to Elastomer Options in Section 9.

²Air Valve Assembly includes item numbers 2 and 3.

³Center Section Assembly includes items numbers 11 and 13.

⁴Large Clamp Band Assembly for standard pumps include items 17 and 19.

⁵Large Clamp Band Assembly for SANIFLO™ FDA pumps include items 17, 18, and 20.

All boldface items are primary wear parts.

EXPLODED VIEW AND PARTS LIST

Item	Description	Model Description		XP2/AXJJJ	XP2/SXJJJ	XP2/SXJJJ/2070
		Qty	P/N	P/N	P/N	
AIR DISTRIBUTION COMPONENTS						
1	Air Valve, Pro-Flo™ Assembly¹	1			01-2010-25	
2	End Cap, Pro-Flo™	1			01-2332-25	
3	O-Ring, End Cap (-126) (Æ1.362 X Æ.103)	1			01-2395-52	
4	Gasket, Air Valve, Pro-Flo™	1			01-2615-52	
5	Gasket, Muffler Plate, Pro-Flo™	1			01-3505-52	
6	Muffler Plate, Pro-Flo™	1			01-3181-25	
7	Screw, SHC, 1/4"-20 X 3"	4			01-6001-03	
8	Muffler	1			02-3510-99	
9	Center Section Assembly, Pro-Flo™ ²	1			02-3145-25	
10	Shaft Seal	2			02-3210-55-225	
11	Bushing, Reducer	1			01-6950-20	
12	Pilot Sleeve Assembly	1			02-3880-99	
13	Pilot Spool Retaining O-Ring	2			04-2650-49-700	
14	Retaining Ring	2			00-2650-03	
WETTED PATH COMPONENTS						
15	Chamber, Liquid	2	02-5004-01	02-5004-03		02-5004-03P
16	Clamp Band Assy. Large ^{3,4}	2	02-7300-08-400			02-7300-03-400
17	Bolt, RHSN, 5/16"-18 X 2"	4	08-6050-08-50			08-6050-03-500
18	Washer, (.344 I.D. X .688 O.D. X .065 THK) (not shown)	4				02-6731-03
19	Nut, Hex, 5/16"-18	4	04-6420-08	08-6400-03		
20	Wing Nut, 5/16"-18 (not shown)	4				08-6661-10
21	Manifold, Inlet (NPT)	1	02-5084-01	02-5084-03		
	Manifold, Inlet (BSPT)	1	02-5086-01	02-5086-03		
	Manifold, Inlet (Tri-Clamp)	1				02-5088-03-70P
22	Bolt, RHSN, 3/8"-16 X 8 1/2"	4	02-6080-08			02-6080-03
23	Manifold, Discharge (NPT)	1	02-5024-01	02-5024-03		
	Manifold, Discharge (BSPT)	1	02-5026-01	02-5026-03		
	Manifold, Discharge (Tri-Clamp)	1				02-5028-03-70P
24	Washer, Flat (Ø.390 X Ø.625 X .063)	4	15-6720-08			02-6730-03
25	Nut, Hex, 3/8"-16	4	02-6430-08	02-6430-03		
26	Wing Nut, 3/8"-16 (not shown)	4				08-6671-10
VALVE BALLS/VALVE SEATS/VALVE O-RINGS						
27	Valve Ball	4		*		
28	Valve Seat	4		*		02-1120-03P
29	O-Ring, Valve Seat (-216) (Ø1.109 X Ø.139)	4		*		
FULL STROKE RUBBER/TPE/PTFE/FSIPD COMPONENTS						
30	Shaft, P2 Pro-Flo™ (Non-PTFE)	1			02-3810-03	
31	Shaft Stud, 3/8"-16 X 1-1/4"	2				02-6150-03-85
32	Spring, Disk	2			02-6802-08	
33	Piston, Inner, P2 Pro-Flo™ (Non-PTFE)	2			02-3701-01	
34	Diaphragm, Back-Up	2			*	
35	Diaphragm, Primary	2			*	
	Diaphragm, IPD, Primary	2			*	
36	Piston, Outer, (Non-PTFE)	2	02-4550-01	02-4550-03		02-4550-03P
REDUCED STROKE PTFE/IPD COMPONENTS						
30	Shaft, Pro-Flo™ (PTFE)	1			02-3840-03	
31	Shaft Stud, 3/8"-16 X 1-1/4"	2				02-6150-03-85
32	Spring, Disk	2			02-6802-08	
33	Piston, Inner, P2 Pro-Flo™ (PTFE)	2			02-3751-01	
34	Diaphragm, Back-Up, Reduced Stroke PTFE	2			*	
35	Diaphragm, Primary, Reduced Stroke PTFE	2			*	
	Diaphragm, IPD Primary, Reduced Stroke PTFE	2			*	
36	Piston, Outer, (PTFE)	2	02-4601-01	02-4600-03		02-4600-03P

*Refer to Elastomer Options in Section 9.

¹Air Valve Assembly includes item numbers 2 and 3.

²Center Section Assembly includes items numbers 10 and 11.

³Large Clamp Band Assembly for standard pumps include items 17 and 19.

⁴Large Clamp Band Assembly for SANIFLO™ FDA pumps include items 17, 18, and 20.

All boldface items are primary wear parts.

EXPLODED VIEW AND PARTS LIST

P2 METAL SANIFLO – 1935 / 2004 / EC

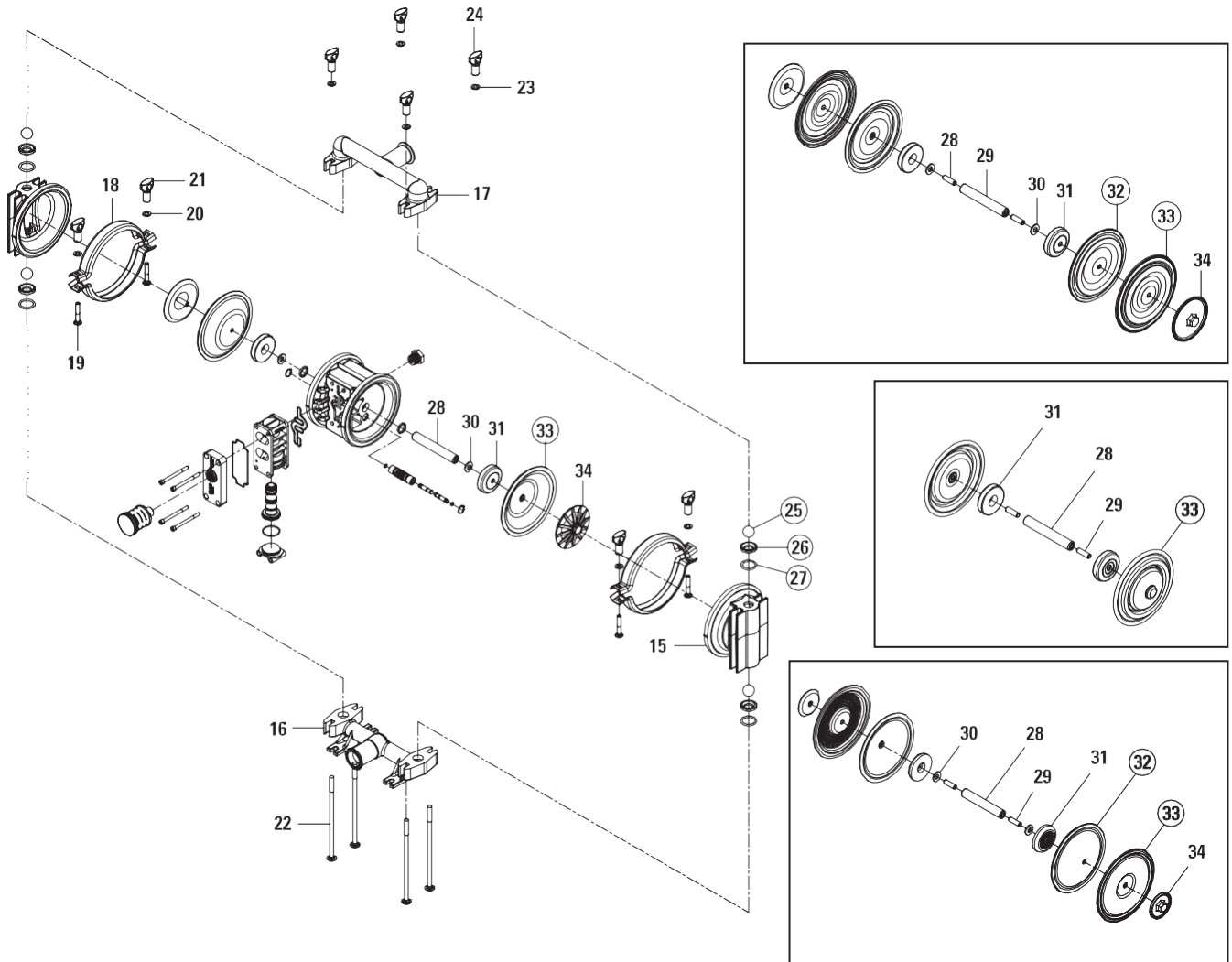

EXPLODED VIEW AND PARTS LIST

Item	Description	Qty	P2/SXLL/1935/2004/EC P/N	P2/SSPPP/1935/2004/EC P/N
Air Distribution Components				
1	Air Valve, Pro-Flo™ Assembly¹	1	01-2010-13	01-2010-20
2	End Cap, Pro-Flo™	1	01-2332-13	01-2332-20
3	O-Ring, End Cap (-126) (Æ1.362 X Æ.103)	1		01-2395-52
4	Gasket, Air Valve, Pro-Flo™	1		01-2615-52
5	Gasket, Muffler Plate, Pro-Flo™	1		01-3505-52
6	Muffler Plate, Pro-Flo™	1	01-3181-13	01-3181-20
7	Screw, SHC, 1/4"-20 X 3"	4		01-6001-03
8	Muffler, 1/2" MNPT	1		02-3510-99
9	Center Section Assembly, Pro-Flo™ ²	1	02-3145-13	02-3145-20
10	Assembly, Pilot Sleeve	1		02-3880-99
11	O-Ring (-009), Pilot Spool Retaining (Ø.208" x Ø.070")	2		04-2650-49-700
12	Seal, Shaft	2		02-3210-55-225
13	Bushing, Reducer, 1/2" MNPT TO 1/4" FNPT	1	01-6950-13	01-6950-20
14	Ring, Retaining	2		00-2650-03
Wetted Path Components				
15	Chamber, Liquid	2		02-5004-03P
16	Manifold, Inlet (Tri-Clamp)	1		02-5088-03-70P
17	Manifold, Discharge (Tri-Clamp)	1		02-5028-03-70P
18	Clamp Band Assembly, Large ^{3,4}	2		02-7300-03-400
19	RHSN Bolt, Large Clamp Band (5/16"-18 X 2")	4		08-6050-03-500
20	Washer, Flat (Ø.344 X Ø.688 X .065")	4		02-6731-03
21	Wing Nut, (5/16"-18)	4		08-6661-10
22	RHSN Bolt, Liquid Chamber (3/8"-16 X 8-1/2")	4		02-6080-03
23	Washer, Flat (Ø.392 X Ø.875 X .062)	4		08-6720-07-70
24	Wing Nut, (3/8"-16)	4		08-6671-10
Valve Balls/Valve Seats/Valve O-Rings				
25	Valve Ball, Pkg 4	1		*
26	Valve Seat	4		02-1120-03E
27	O-Ring (-216), Valve Seat (Ø1.109 X Ø.139), Pkg 4	1		*
Full Stroke Rubber/TPE/PTFE/FSIPD Components				
28	Shaft, P2 Pro-Flo™ (Non-PTFE)	1		02-3810-03
29	Stud, Shaft (3/8"-16 X 1-1/4")	2		02-6150-03-85
30	Spring, Disk	2		02-6802-08
31	Piston, Inner, P2 Pro-Flo™ (Non-PTFE)	2		02-3701-01
32	Diaphragm, Back-Up, Pkg 2	1		*
33	Diaphragm, Primary, Pkg 2	1		*
	Diaphragm, Full Stroke PTFE, Primary, Pkg 2	1		02-1040-55E
	Diaphragm, Full Stroke IPD, Primary, Pkg 2	1		02-1031-56E
34	Piston, Outer, (Non-PTFE)	2		02-4550-03P
Reduced Stroke PTFE/IPD Components				
28	Shaft, Pro-Flo™ (PTFE)	1		02-3840-03
29	Stud, Shaft (3/8"-16 X 1-1/4")	2		02-6150-03-85
30	Spring, Disk	2		02-6802-08
31	Piston, Inner, P2 Pro-Flo™ (PTFE)	2		02-3751-01
32	Diaphragm, Back-Up, Pkg 2	1		*
33	Diaphragm, Primary, Pkg 2	1		*
	Diaphragm, Primary (PTFE), Pkg 2	1		02-1010-55E
	Diaphragm, Integral Piston, Pkg 2	1		02-1010-72-85E
34	Piston, Outer, (PTFE)	2		02-4600-03P

¹Air Valve Assembly includes item numbers 2 and 3.

²Center Section Assembly includes items numbers 11 and 13.

³Large Clamp Band Assembly for standard pumps include items 17 and 19.

⁴Large Clamp Band Assembly for SANIFLO™ FDA pumps include items 17, 18, and 20.

All boldface items are primary wear parts.

SECTION 9

ELASTOMER OPTIONS

P2 METAL

MATERIAL	DIAPHRAGMS (2)	FULL STROKE DIAPHRAGMS (2)	FULL STROKE BACK-UP DIAPHRAGMS (2)	FULL STROKE IPD DIAPHRAGMS (2)	REDUCED STROKE DIAPHRAGMS (2)	REDUCED STROKE BACK-UP DIAPHRAGMS (2)	REDUCED STROKE IPD DIAPHRAGMS (2)	VALVE BALLS (4)	VALVE SEATS (4)	VALVE SEAT O-RINGS (4)
Polyurethane	02-1010-50							02-1080-50		02-1200-50
Neoprene	02-1010-51					02-1060-51		02-1080-51		02-1200-51
Buna-N®	02-1010-52							02-1080-52		02-1200-52
Food Grade Buna-N®	02-1010-69									
FKM	02-1010-53							02-1080-53		
EPDM	02-1010-54					02-1060-54		02-1080-54		02-1200-54
Food Grade EPDM	02-1010-74									
PTFE		02-1040-55			02-1010-55		02-1010-72-85	02-1080-55		02-1200-55
Non-Food Grade Saniflex™				02-1031-46						
Saniflex™	02-1010-56		02-1065-56	02-1031-56		02-1060-56		02-1080-56		02-1200-56
Food Grade Wil-Flex®	02-1010-57		02-1067-57	02-1031-57						
Wil-Flex®	02-1010-58			02-1031-58				02-1080-58		02-1200-58
Aluminum									02-1120-01	
Stainless Steel									02-1120-03	

LW0501 REV. A1

P2 METAL SANIFLO™ – 1935 / 2004 / EC

MATERIAL	DIAPHRAGMS	REDUCED STROKE BACK-UP DIAPHRAGMS	FULL STROKE DIAPHRAGMS	FULL STROKE BACK-UP DIAPHRAGMS	REDUCED STROKE IPD DIAPHRAGMS	FULL STROKE IPD DIAPHRAGMS	IPD DIAPHRAGMS BACK-UP DIAPHRAGMS	VALVE BALLS	VALVE SEAT O-RINGS
FDA BUNA-N	02-1010-69E								
FDA EPDM	02-1010-74E	02-1060-54E							
SANIFLEX™	02-1010-56E	02-1060-56E		02-1065-56E		02-1031-56E		02-1080-56E	02-1200-56E
FDA WILFLEX®	02-1010-57E			02-1065-57E					
PTFE	02-1010-55E		02-1040-55E		02-1010-72-85E		02-1060-55-85E	02-1080-55E	02-1200-55E

LW0083 REV. C

WILDEN®

DECLARATION OF CONFORMITY



PSG California LLC, 22069 Van Buren Street, Grand Terrace, CA 92313-5607 USA, certifies as the manufacturer that the Air-Operated Double Diaphragm pumps listed below comply with the following European Community Regulations:

(EC) 1935/2004 for Food Contact Materials
(EC) 2023/2006 Good Manufacturing Practice
(EU) 10/2011 on plastic materials and articles intended to come in contact with food

- **25 mm (1") Saniflo Hygienic™ HS Metal Pump:**
(XPS,PS)2(SS,SZ)(SSS,NNN)(FBS,FES,FSL,FSS,LEL,TEU,TSS,TSU)(FB,FE,FS,TF)(FB,FE,FV,TF)(0770-0789)E
- **38 mm – 76 mm (1-½"-3") Pro-Flo X Saniflo Hygienic™ HS Metal Pump:**
(PX,XPX)(4,8,15)(SS,SZ)(SSS,NNN)(BNU,EPU,FBS,FES,FSL,FSS,LEL,TEU,TSS,TSU,ZSS)(FB,FE,FS,FV,SF,TF,TM)(FB,FE,TF)(0770-0789)E
- **38 mm – 76 mm (1-½"-3") Pro-Flo Shift Saniflo Hygienic™ HS Metal Pump:**
(PS,XPS)(4,8,15)(SS,SZ)(SSS,NNN)(FBS,FES,FSL,FSS,LEL,TSS,ZSS)(FB,FE,FS,FV,SF,TF,TM)(FB,FE,TF)(0770-0789)E
- **76 mm (3") Saniflo HS High Pressure Advanced Metal Pump**
H1500(SS,SZ)III(FSL,TSS)(TF,TM)(FE,FV,TF)0770E
- **13 mm (½") Pro-Flo & Pro-Flo X™ Saniflo FDA Metal Pump Models:**
(P,PX,XPX)1(SS,SZ)(AAA,GGG,JJJ,LLL,PPP)(FSL,FSS,TEU,TSU)(FS,TF)(FS,TF)(0067,0070,0120)E
- **25 mm (1") Pro-Flo Saniflo FDA Metal Pump Models:**
P2(SS,SZ)LLL,PPP)(FBS,FES,FSL,FSS,LEL,TEU,TSS,TSU)(FS,TF)(FS,TF)2070E
- **38 mm (1-½") Pro-Flo & Pro-Flo X™ Saniflo FDA Metal Pump Models:**
(P,PX,XPX)(SS,SZ)(AAA,LLL,NNN,SSS)(BNU,EPU,FBS,FES,FSL,FSS,TEU,TSS,TSU)(FS,TF)(FS,STF)(0067,0070,0075,0120)E
- **51 mm (2") Pro-Flo & Pro-Flo X™ Saniflo FDA Metal Pump Models:**
(P,PX,XPX)8(SS,SZ)(AAA,PPP,NNN,SSS)(BNU,EPU,FBS,FES,FSS,TEU,TSU,TSS)(FS,TF)(FS,STF)(0070,0075,0120)E
- **76 mm 3" Pro-Flo X™ Saniflo FDA Metal Pump Models:**
(PX,XPX)15(SS,SZ)(AAA,NNN,SSS)(BNU,EPU,FSL,FSS,TEU,TSU,TSS)(FS,TF)(FS,STF)(0070,0075,0120)E
- **38 mm 1-½" Pro-Flo Shift™ Saniflo FDA Metal Pump Models:**
XPS4(SS,SZ)(AAA,NNN,SSS)(FBS,FES,FSL,FSS,TSS,ZSS)(FS,TF)(FS,STF)(0067,0070,0775,0120)E
- **51 mm 2" Pro-Flo Shift™ Saniflo FDA Metal Pump Models:**
XPS8(SS,SZ)(AAA,NNN,SSS)(FBS,FES,FSL,FSS,TSS,ZSS)(FS,TF)(FS,STF)(0070,0075,0120)E
- **76 mm 3" Pro-Flo Shift™ Saniflo FDA Metal Pump Models:**
XPS15(SS,SZ)(AAA,NNN,SSS)(FSL,FSS,TSS,ZSS)(FS,TF)(FS,STF)(0070,0120,0341)

Materials used in equipment that are intended to contact food belong to the groups of materials listed in Annex 1 (EC) 1935/2004 (List of groups of materials and articles which may be covered by specific measures)

5) Rubbers 8) Metal and Alloy 10) Plastics

Compliance is subject to material and equipment storage, handling and usage recommended by Wilden in the engineering operation and maintenance manual and supplemental technical publications.

This declaration is based on the following information:

- Statements of raw material from suppliers
- Total Migration Analysis per (EU) 10/2011

Wilden will make available to the competent authorities appropriate documentation to demonstrate compliance

Approved By:

Chris Distaso
Director of Engineering
Date: October 10, 2019



NOTES

WILDEN®

PSG
22069 Van Buren Street
Grand Terrace, CA 92313-5651 USA
P: +1 (909) 422 -1730
psgdover.com



Where Innovation Flows

PSG® reserves the right to modify the information and illustrations contained in this document without prior notice. This is a non-contractual document.