



FINISH THOMPSON INC.
Drum Pump **Flow Meter**

Model FM2000 Series
Operating Instructions
P/N 106607 R4



Table of Contents

Safety	3
Introduction.....	3
Specifications	3
Features.....	3
Section 1 - Installation	4
Section 2 - Operation	4
Changing Display from Rate or Total	5
Programming Menu Flow Chart	5
Calibration	5-7
Disabling Front Panel Programming Mode.....	7
Section 3 - Accuracy	8
Section 4 - Maintenance	8
Section 5 - Warranty	8
Section 6 - Spare Parts	9

Safety

ALWAYS wear protective clothing, eye protection, and follow standard safety procedures when handling corrosive or personally harmful materials.

NEVER use this flow meter with flammable or combustible liquids.

NEVER use this flow meter in a hazardous environment.

ALWAYS verify chemical compatibility with the flow meter and pump materials of construction before operation.

ALWAYS make sure the pump and hose are properly supported.

ALWAYS use a chemically compatible hose rated for the temperature of the product being pumped.

ALWAYS place pump tube in liquid before starting.

Introduction

Thank you for purchasing an FM-2000 Series electronic flow meter. The FM-2000 Series is designed to measure the flow of a fluid being dispensed from Finish Thompson's PFP, PFM, PFV, SFM, SFP, SFV, SFVV drum pumps. The meter is factory calibrated and displays information on an LCD display. In addition, the meter can be field calibrated to improve accuracy at a given flow rate. Four AA batteries power the unit for up to one year. There are options for materials of construction and measurement units

FM-2000 is a rate/totalizer meter – designed to measure and display both the rate of flow and the total flow.

Specifications

Minimum Flow Rate:	5 gpm (18.9 lpm)
Maximum Working Pressure:	35-62 PSIG (2.4 – 4.3 bar)
Maximum Fluid Temperature:	200° F (93° C) but limited by pump
Ambient Temperature Range:	32° to 110°F / 0° to 43° C
Enclosure:	NEMA 4X (IP56)
Sensor/Paddle/Axle Material:	PVDF
O-ring seals:	FKM
Accuracy:	+/-1% of full-scale rate reading; can be field calibrated
Repeatability:	+/-1% of full-scale rate reading
Power Requirements:	Four standard AAA alkaline batteries (included)
Battery Life Expectancy:	1 year minimum
Maximum Viscosity:	20 cP/mPas
Maximum Specific Gravity:	1.8

Features

- Easy to read eight digit LCD display
- Installs quickly on PFM, PFP, PFV, SFM, SFP, SFV, SFVV Series pump tubes with supplied fittings
- Factory calibrated; can be field calibrated using front panel touch buttons
- Minimal maintenance required
- Corrosion resistant PVDF sensor with polypropylene or PVDF body, ABS electronics enclosure
- Weather resistant enclosure
- High accuracy· Non-volatile memory stores settings even when batteries are removed

Kit Contents:

- FM-2000 Series Meter
- Flow meter adapter
- Discharge nut
- 1" NPT coupling
- Hose barb adapter

Section 1 - Installation

NOTE: Avoid exposing the LCD for prolonged periods to direct sunlight or the life of the LCD may be reduced.

1. Determine which direction the flow meter display is to face. It is bi-directional and can face either to the right or left but must be kept in the upright position.
2. Wrap Teflon tape on threads of both ends of flow meter (Item 1). Screw Hose Barb Adapter (Item 2) onto discharge end of flow meter. Tighten securely by hand or wrench, being very careful not to over-tighten.
3. Screw 1" NPT coupling (item 3) onto the other end of the flow meter. Tighten securely by hand or wrench, being very careful not to over-tighten.
4. Remove discharge nut, spout and o-ring (items 6, 7, & 8) from pump discharge. Discard the discharge nut and spout (or save for later use if no longer using the pump with a flow meter). Save the o-ring for use in the next step.
5. For SF models, install the o-ring into the o-ring groove of the Flowmeter Adapter (item 5). For all models, place the flow meter adapter (item 5) into the discharge nut (item 4) supplied with the flow meter kit. Threads of the adapter will protrude through the front of the discharge nut. For PF models, place the o-ring (item 6) inside the discharge nut (item 4). Press down on the o-ring to ensure it is seated in the nut.
6. Screw discharge nut/adapter/o-ring assembly onto the discharge of the pump tube. Tighten securely but do not over-tighten. This step prevents the adapter from rotating when the flow meter is installed.
7. Grasping the flow meter body (being careful not to put pressure on the digital display), screw the flow meter assembly onto the 1" NPT discharge adapter on the pump tube until tight. If the flow meter display is not in the upright position proceed to step 8 for adjustment.
8. Using a wrench, loosen the discharge nut (item 4) on the discharge of the pump tube. Position the flow meter assembly so the display is in the upright position and retighten the discharge nut (while holding the flow meter assembly).
9. Attach 1" ID hose to the hose barb located at the discharge end of the flow meter. Secure with a hose clamp.

Warning: Use chemically compatible hose rated for the temperature of the product being pumped.

Section 2 - Operation

NOTES:

- Depending on the meter purchased, the FM-2000 is calibrated for and displays either GPM (US gallons per minute) or LPM (liters per minute).
- The meter is shipped from the factory with 4 AA pre-installed batteries.
- The FM-2000 Series is factory calibrated to $\pm 1\%$ of full-scale rate reading. Accuracy is based on laboratory testing using a PF Series pump tube.
- Unit is factory calibrated for water. If using a fluid other than water and calibration is required proceed to section "Calibration" on page 3 before proceeding with the steps listed below.
- If battery saver mode is activated through program change, press any button to activate display. Factory default battery saver mode is NOT activated.

Theory of Operation

Start the pump motor. Fluid flowing through the meter causes a paddle wheel to spin. Pulses generated by the spinning paddle wheel are counted and multiplied by scaling factors. The resulting flow rate amounts and total flow amounts are displayed on the LCD readout. Pressing the enter button located on the front panel toggles the display between flow rate and total flow or allows entry into the programming mode. Pressing the clear total button while the total flow value is displayed will return the total to zero. The LCD indicates the mode being displayed.

Changing display from Rate or Total

- Press to toggle between RATE and TOTAL display modes. The icon will light to indicate the active mode.

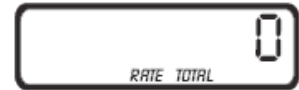

- While the TOTAL mode is displayed, press to reset the total amount to



Programming Menu Flow Chart

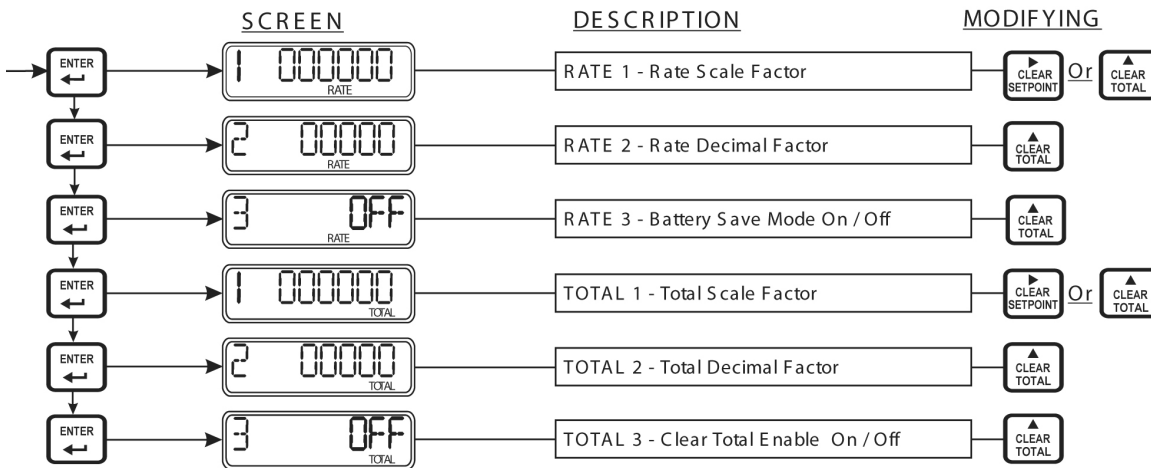

Calibration

While the FM-2000 has been calibrated at the factory, field calibration is possible to increase accuracy at a given flow. Use the following steps for field calibration.

NOTE: If the meter has been previously field calibrated, the scale factors (Rate Scale and Total Scale factor) will need to be reset to factory default values. Refer to "Step Six" using the default values from Figure 2.

NOTE: If the Front Panel Programming has been disabled, the meter cannot be calibrated until the Front Panel Programming has been re-enabled. See "Disabling Front Panel Programming" Section. The factory default setting is "enabled" which allows changes to be made,

Step One – Determine Actual Volume versus Meter Reading

Compare the actual volume of the fluid being pumped with the volume shown on the meter. You can either use a calibrated container or you can use a known weight. In either case, use as large a container as practical (for instance five-gallon versus one-gallon container).

NOTE: Press the button while in the "Total" main menu to reset the value to zero before starting the calibration process.

Step Two – Determine Multiplier Factor

To use the "volume" process, use the following steps:

- Fill the container until it reaches the known volume mark.
- Divide the known volume by the reading on the meter. Record this multiplier _____

For example, if using a five-gallon container and the meter reads 5.2 gallons the multiplier is .96.

To use the "known weight" process, use the following steps:

- Weigh the container. Record this weight _____.
- Fill the container with fluid. Record this weight _____.
- Record the "total" volume of fluid shown on the meter display _____.
- Subtract the weight of the container from the weight recorded in step b to arrive at a net fluid weight _____.
- Determine fluid density. Water weighs approximately 8.33 pounds per US gallon or 1 kg per liter. To determine fluid density (weight per volume unit), multiply the weight of water per gallon or liter by the specific gravity of the fluid (found on MSDS). Record density _____

For example, the specific gravity on the MSDS for 93% sulfuric acid is shown as 1.84. $8.33 \text{ pounds per gallon} \times 1.84 = 15.33$ pounds per gallon (density) for 93% sulfuric acid.

f. Divide the net fluid weight by the fluid density to determine volume. Record the known volume _____.

For example, the net weight is 41.65 pounds; the fluid is water with a density of 8.33 pounds per gallon; 41.65 divided by $8.33 = 5$ (gallons)

g. Divide the known volume by the reading on the meter. Record this multiplier _____

For example, if using a five-gallon container and the meter reads 5.2 gallons the multiplier is .96.

Step Three – Calculate new Rate Scale Factor

For gallons per minute

NOTE: Factory default Rate Scale Factor is 018.458
Multiply multiplier factor by factory rate scale factor.

For example, $.96 \times 018.458 = 017.720$

Record the number here _____ and also below in “Step Six” part b.

For liters per minute

NOTE: Factory default Rate Scale Factor is 069.872
Multiply multiplier factor by factory rate scale factor.

For example, $.96 \times 069.872 = 067.077$

Record the number here _____ and also below in “Step Six” part b.

Step Four – Calculate new Total Scale Factor

For gallons per minute

NOTE: Factory default Total Scale Factor is 00.3076
Take the Rate Scale Factor from Step three and divide by 60.

For example if the Rate Scale factor from Step three is 017.720, the Total Scale Factor is 00.2953

Record the number here _____ and also below in “Step Six” part g.

For liters per minute

NOTE: Factory default Total Scale Factor is 01.1645
Take the Rate Scale Factor from Step three and divide by 60.

For example if the Rate Scale factor from Step three is 067.077, the Total Scale Factor is 01.1180

Record the number here _____ and also below in “Step Six” part g.

Step Five – Enter programming menu

To enter programming mode, press and hold the  button on the front of the meter for at least 2 seconds.

Step Six – Enter the Rate Scale Factor and Total Scale Factors







NOTE: Meter automatically exits programming mode after 20 seconds of button inactivity. Any changes made will be lost (new value will not be stored).

a) Enter the Rate Scale Factor from Step Three.

Rate scale factor from “Step Three”

b) Press the  button to select the digit to be modified. The selected digit will blink. The decimal point will blink after all the numbers have been cycled through. Do not change the decimal point.

c) Press the  button to modify the selected digit. Repeat the process until all digits have been modified.

- d) When finished, press the  button. The screen changes to the RATE 2 ("2" is in left corner of display) screen.
Do not make changes on this screen. Go to the next screen by pressing the  button.
- e) The screen changes to the RATE 3 ("3" is in left corner of display) screen. Do not make changes on this screen. Go to the next screen by pressing the  button.
- f) The screen changes to the Total 1 ("1" is in left corner of display) screen. Enter the Total Scale Factor from Step four.
- g) **Total Scale Factor from "Step Four "**
- h) Press the  button to select the digit to be modified. The selected digit will blink. The decimal point will blink after all the numbers have been cycled through. Do not change the decimal point.
- i) Press the  button to modify the selected digit. Repeat the process until all digits have been modified.
- j) To save setting and exit Programming Mode, press and hold the  button for at least two seconds.

NOTE: There are two additional screens that are not required for calibration that have been skipped by exiting at this point.

Note: To verify that the meter is properly calibrated, repeat Step one. If not, repeat calibration process. Return the Rate Scale Factor and Total Scale Factor to factory settings prior to repeating steps one through six.

Disabling the Front Panel Programming Mode:

The programming mode can be disabled by using a jumper to prevent changing of parameters, for instance after the meter has been field calibrated.

To disable the Front Panel Programming Mode, remove four Phillips head screws from front of meter. Remove cover to expose meter internals. Install jumper on J2 ("P" is also underneath). See Figure 1 below.

Figure 1

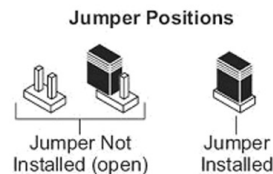
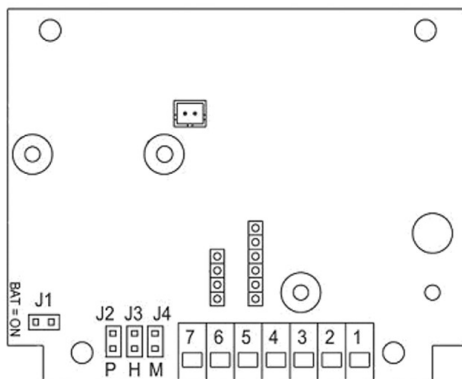

Figure 2 - Factory Default Chart

SCREEN	DESCRIPTION	DEFAULT
	RATE 1 - Rate Scale Factor	018.458 (GPM) / 069.872 (LPM)
	RATE 2 - Rate Decimal Factor	.00
	RATE 3 - Battery Save Mode On / Off	OFF
	TOTAL 1 - Total Scale Factor	00.3076 (Gal.) / 01.1645 (L)
	TOTAL 2 - Total Decimal Factor	.00
	TOTAL 3 - Clear Total Enable On / Off	ON

Section 3 - Accuracy

The accuracy of these flow meters is published as Full Scale Accuracy. This means the amount of error is relevant to the Full Scale, which is 50 gpm for the FM2000. For example, if the flow meter is displaying 5 gpm, and you measure the actual flow to be 5.4 gpm, then your full scale accuracy is calculated as $(\text{Measured}-\text{Actual}) / \text{Full Scale}$...or $5 \text{ minus } 5.4 \text{ divided by } 50$ which equals .008 or .8%.

On the other hand, the Actual Accuracy is calculated as $5 \text{ minus } 5.4 \text{ divided by } 5.4$ which equals .074 or 7.4%. Notice this value is nearly 10X higher. As you increase your flow towards the Full Scale value, your Full Scale Accuracy and your Actual Accuracy become the same.

Similarly, when using these flow meters (FM2000) to measure volume, the accuracy is affected by the flow rate. When pumping at low flow rates, Actual Accuracy will be high. Also, small measured batches are sensitive to error incurred from varying setups, such as hose length, valves, head.

More accuracy can be obtained by using an FM2000 or FM3000 flow meter and field calibrating the meter to the specific flow rate and setup.

Section 4 - Maintenance

The FM-2000 Series is engineered for low maintenance; however, some conditions can cause increased wear on the paddle and/or possible damage to the unit. Damage caused by corrosives incompatible with the meter's materials of construction or abrasive fluids is not covered under warranty.

- Periodically remove the sensor from the molded in-line body and inspect for signs of wear and obstructions. Clean the paddle of any foreign material. Inspect the o-rings for any sign of wear, swelling, cracking or discoloration. Replace if necessary.
- The meter is designed to withstand minor condensation inside the enclosure. Prolonged excessive moisture inside the enclosure, due to high humidity conditions, may damage the meter. Reduce the humidity or move the meter to a cool, dry location.
- Replace the four AA batteries every 12 months. The program memory is "non-volatile" and will not erase when replacing the batteries. To replace the batteries, open the front panel of the enclosure by removing the four Phillips screws. After replacing the batteries, be sure the foam insert is in the place and the panel gasket seal is in good condition, before closing the rear panel.

Section 5 - Warranty

Finish Thompson, Inc (manufacturer) warrants this product to be free of defects in materials and workmanship for a period of one year from date of purchase by original purchaser. If a warranted defect, which is determined by manufacturer's inspection, occurs within this period, it will be repaired or replaced at the manufacturer's option, provided (1) the product is submitted with proof of purchase date and (2) transportation charges are prepaid to the manufacturer. Liability under this warranty is expressly limited to repairing or replacing the product or parts thereof and is in lieu of any other warranties, either expressed or implied. This warranty does apply only to normal wear of the product or components. This warranty does not apply to products or parts broken due to, in whole or in part, accident, overload, abuse, chemical attack, tampering, or alteration. The manufacturer accepts no responsibility for product damage or personal injuries sustained when the product is modified in any way. If this warranty does not apply, the purchaser shall bear all cost for labor, material and transportation.

Manufacturer shall not be liable for incidental or consequential damages including, but not limited to process down time, transportation costs, costs associated with replacement or substitution products, labor costs, product installation or removal costs, or loss of profit. In any and all events, manufacturer's liability shall not exceed the purchase price of the product and/or accessories

Section 6 - Spare Parts

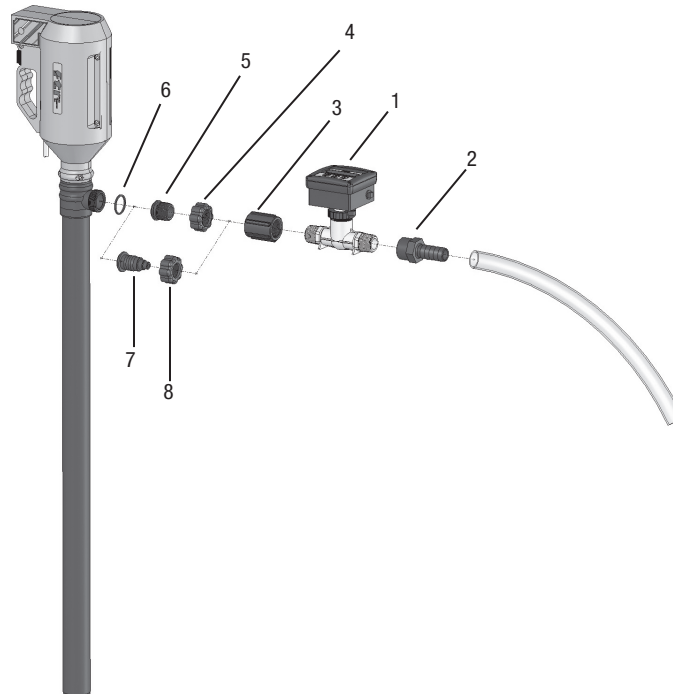

Item Number	Qty.	Description	PF Series Part Number	SF Series Part Number
1	1	Flow Meter	N/A	N/A
2	1	Hose Barb Adapter-PP-1"FNPT x 1"Barb	106601	106601
	1	Hose Barb Adapter-PVDF-1"FNPT x 1"Barb	106601-1	106601-1
3	1	Coupling-PP-1"FNPT x 1"FNPT	106600	106600
	1	Coupling-PVDF-1"FNPT x 1"FNPT	106610	106610
4	1	Flow Meter Discharge Nut-PP	106622	111258-1
	1	Flow Meter Discharge Nut-PVDF	106622-1	111258-2
5	1	Flow Meter Adapter-PP-1"MNPT	106599	111257-1
	1	Flow Meter Adapter-PVDF-1"MNPT	106599-1	111257-2
6	1	O-ring- FKM	J100991	109526
7	1	Hose Barb-Standard-PP	M100028-1	111204-1
	1	Hose Barb-Standard-PVDF	M100028-2	111204-2
8	1	Discharge Nut-Standard-PP	M101610-1	111205-1
	1	Discharge Nut-Standard-PVDF	M101610-2	111205-2



FINISH THOMPSON INC.

921 Greengarden Road • Erie, PA 16501-1591 U.S.A.
 Ph 814-455-4478 • Fax 814-455-8518
 Email fti@finishthompson.com • www.finishthompson.com

Part Number 106607 R4
 11/19/2020