

BALDOR® • ***RELIANCE***

Product Information Packet

EM2547T-12

60HP, 1775RPM, 3PH, 60HZ, 364T, 4278M, OPSB, F1

Part Detail							
Revision:	N	Status:	PRD/A	Change #:		Proprietary:	No
Type:	AC	Prod. Type:	4278M	Elec. Spec:	42WGW658	CD Diagram:	CD0104
Enclosure:	OPSB	Mfg Plant:		Mech. Spec:	42E211	Layout:	42LYE211
Frame:	364T	Mounting:	F1	Poles:	04	Created Date:	07-29-2009
Base:	RG	Rotation:	R	Insulation:	F	Eff. Date:	01-03-2017
Leads:	12#8					Replaced By:	
Literature:		Elec. Diagram:					

Nameplate NP2138L											
CAT.NO.	EM2547T-12			P/N				ENCLOSURE	OPSB		
SPEC.	42E211W658		CC	010A	FRAME	364T		S/N			
HP	60			CLASS	F	HZ	60				
RPM	1775		PH	3	DES	B					
VOLT	230/460			KVA-CODE	G		ODE BRG	6311		DE BRG	6313
AMP	136/68			USABLE AT 208V	144						
RATING	40C AMB-CONT			GREASE	POLYREX EM						
NEMA-NOM-EFF	95	PF	87	SER.F.	1.15						
HTR-VOLTS			HTR-AMPS			MAX. SPACE HEATER TEMP.					

Parts List		
Part Number	Description	Quantity
SA184472	SA 42E211W658	1.000 EA
RA172307	RA 42E211W658	1.000 EA
HA6360	LIFTING LUG FOR 42 FRAME MOTORS.	2.000 EA
HA6017	CAST ADAPTER, 40,42 KOBX	1.000 EA
19XW3118A12	.31-18 X .75 HEX WASHER HEAD TAPTITE II	2.000 EA
HW1001A31	LOCKWASHER 5/16, ZINC PLT.591 OD, .319 I	2.000 EA
10CB3002	CONDUIT BOX CAST W/3.625 LEAD HOLE	1.000 EA
19XW3118A12	.31-18 X .75 HEX WASHER HEAD TAPTITE II	4.000 EA
HW1001A31	LOCKWASHER 5/16, ZINC PLT.591 OD, .319 I	4.000 EA
WD1000B16	T&B CX70TN TERMINAL	1.000 EA
51XF2520A08	SCREW, HEX SER SLT HD, ZN 1/4-20 X .50 L	1.000 EA
42EP3200A01	FR ENDPLATE, MACH 324-6T	1.000 EA
HW5100A13	W4627-047 WVY WSHER	1.000 EA
42EP1202A01	STD PU ENDPLATE MODEL 42 313 BRG.	1.000 EA
10XN3816K44	3/8-16 X 2.75 HEX HD CAP SCREW, GRADE 5	4.000 EA
HW1001A38	LOCKWASHER 3/8, ZINC PLT .688 OD, .382 I	4.000 EA
XY5013A12	NUT,1/2-13,HEX,STEEL,ZINCPLATED	8.000 EA
10CB3500SP	CONDUIT BOX LID, CAST	1.000 EA
51XW2520A12	.25-20 X .75, TAPTITE II, HEX WSHR SLTD	4.000 EA
HW2501J36	KEY, 5/8 SQ X 4.250	1.000 EA
LB1115N	LABEL,LIFTING DEVICE (ON ROLLS)	1.000 EA
MN416A01	TAG-INSTAL-MAINT no wire (1000/bx) 11/14	1.000 EA
HA4051A00	PLASTIC CAP FOR GREASE FITTING	1.000 EA
HW4500A03	GREASE FITTING, .125 NPT 1610(ALEMITE) 8	1.000 EA

Parts List (continued)		
Part Number	Description	Quantity
HW4500A20	1/8NPT SL PIPE PLUG	1.000 EA
MJ1000A02	GREASE, POLYREX EM EXXON (USe 4824-15A)	0.030 LB
HA4051A00	PLASTIC CAP FOR GREASE FITTING	1.000 EA
HW4500A03	GREASE FITTING, .125 NPT 1610(ALEMITE) 8	1.000 EA
HW4500A20	1/8NPT SL PIPE PLUG	1.000 EA
MG1000Y03	MUNSELL 2.53Y 6.70/ 4.60, GLOSS 20,	0.080 GA
85XU0407S04	4X1/4 U DRIVE PIN STAINLESS	2.000 EA
42AD2001A01	BAFFLE PLATE 42 OPEN, SLOTTED BAND MTRS	1.000 EA
42AD2001A01	BAFFLE PLATE 42 OPEN, SLOTTED BAND MTRS	1.000 EA
HA3151A12	THRUBOLT STUD 1/2-13 X 23.00	4.000 EA
LB1119N	WARNING LABEL	1.000 EA
LC0104A01	CONNECTION DIAGRAM	1.000 EA
NP2138L	ALUM SUPER-E UL CSA-EEV PREM CC (300	1.000 EA
42PA1000	PACKAGING GROUP PRINT PK1024A06	1.000 EA

AC Induction Motor Performance Data

Record # 25763 - Typical performance - not guaranteed values

Winding: 42WGW658-R001	Type: 4278M	Enclosure: OPSB
-------------------------------	--------------------	------------------------

Nameplate Data				460 V, 60 Hz: High Voltage Connection	
Rated Output (HP)	60			Full Load Torque	177 LB-FT
Volts	230/460			Start Configuration	direct on line
Full Load Amps	136/68			Breakdown Torque	624 LB-FT
R.P.M.	1775			Pull-up Torque	245 LB-FT
Hz	60	Phase	3	Locked-rotor Torque	314 LB-FT
NEMA Design Code	B	KVA Code	G	Starting Current	470 A
Service Factor (S.F.)	1.15			No-load Current	22.2 A
NEMA Nom. Eff.	95	Power Factor	87	Line-line Res. @ 25°C	0.0815 Ω
Rating - Duty	40C AMB-CONT			Temp. Rise @ Rated Load	30°C
S.F. Amps				Temp. Rise @ S.F. Load	36°C
				Locked-rotor Power Factor	26
				Rotor inertia	10.4 LB-FT ²

Load Characteristics 460 V, 60 Hz, 60 HP

% of Rated Load	25	50	75	100	125	150	S.F.
Power Factor	56	77	85	87	88	88	88
Efficiency	92.7	94.9	95.5	95	94.5	93.9	94.7
Speed	1793	1787	1781	1775	1769	1762	1771
Line amperes	27.3	38.7	52.1	67.6	83.6	101	77.2

Performance Graph at 460V, 60Hz, 60.0HP Typical performance - Not guaranteed values

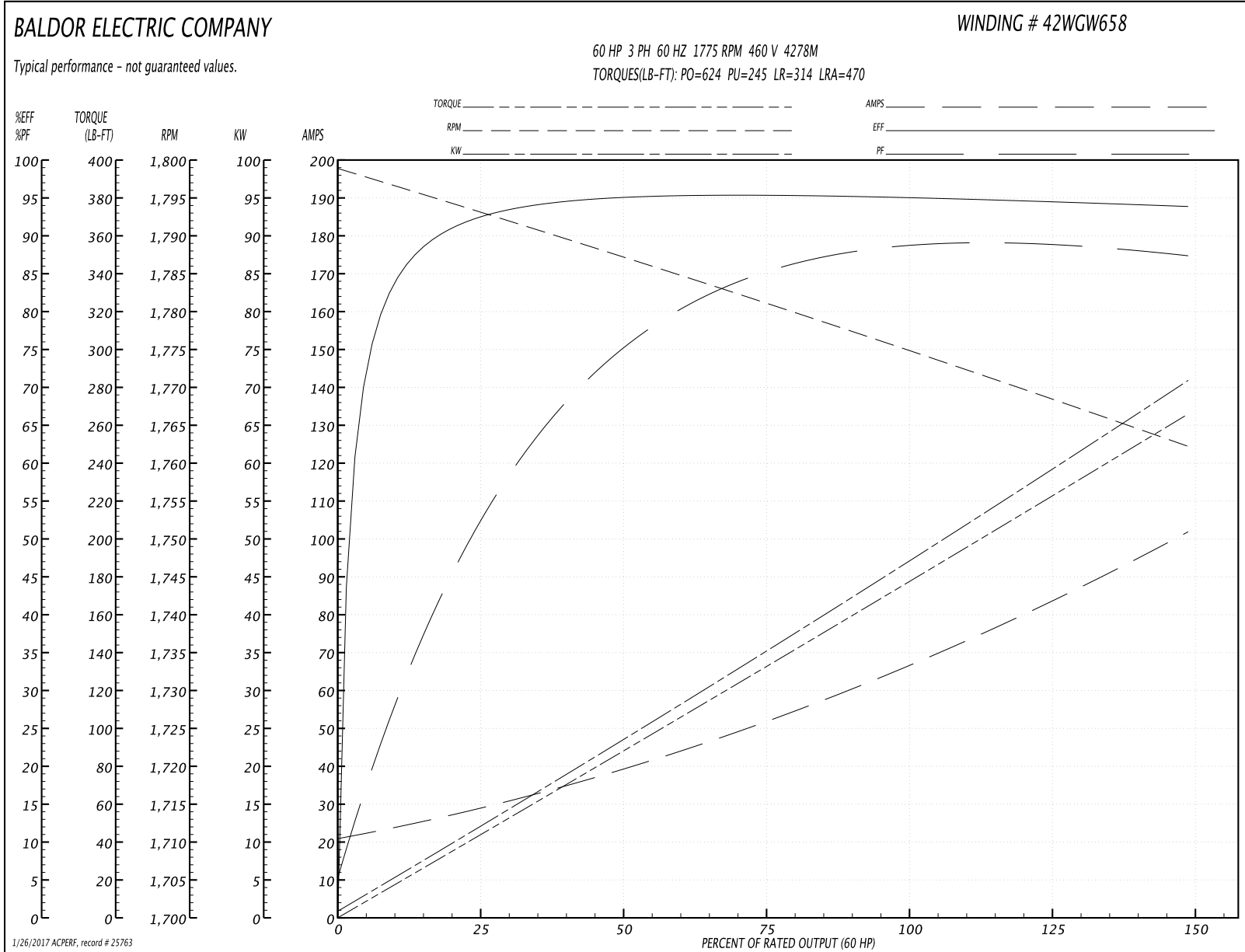

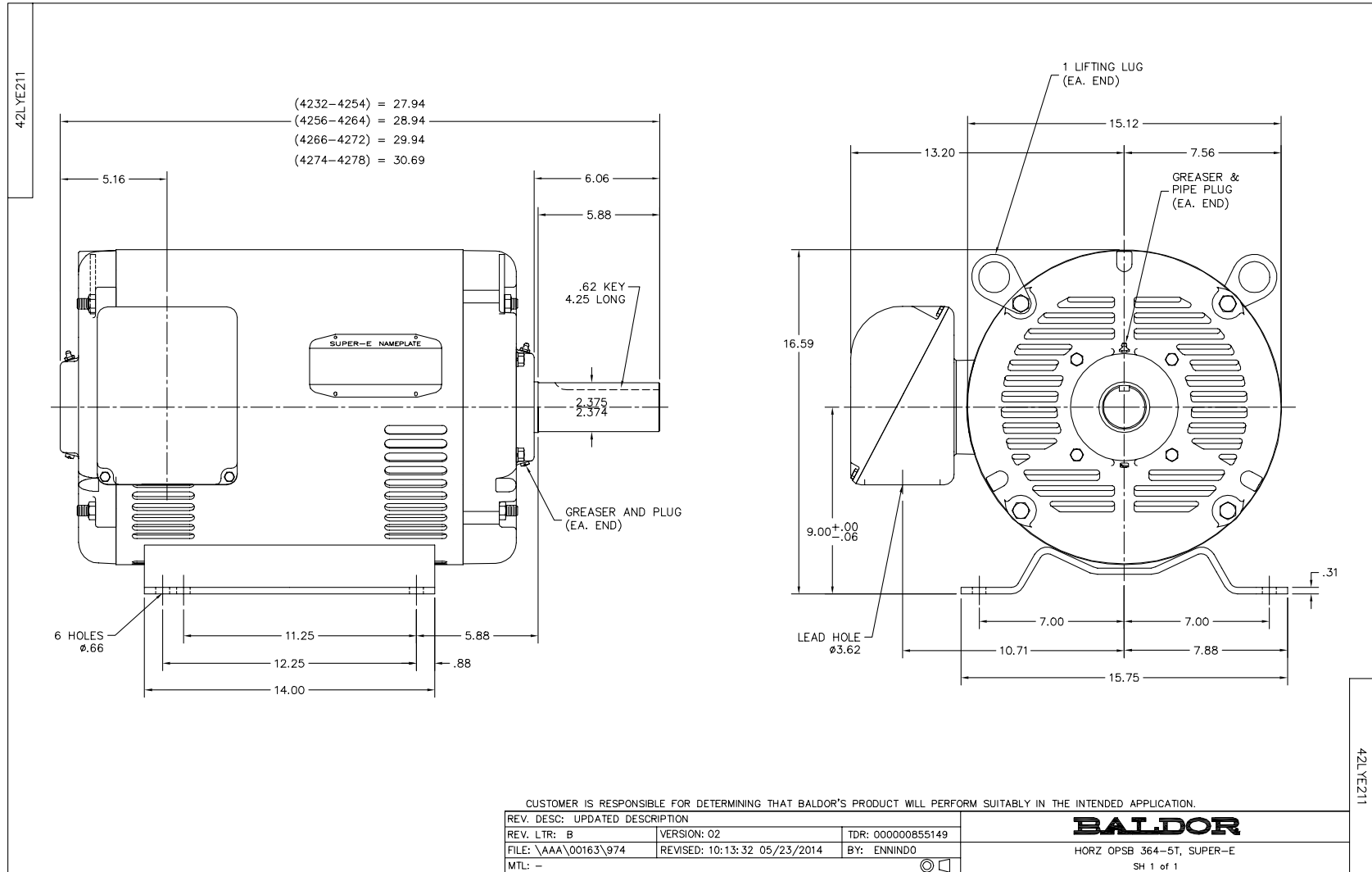

CD0104

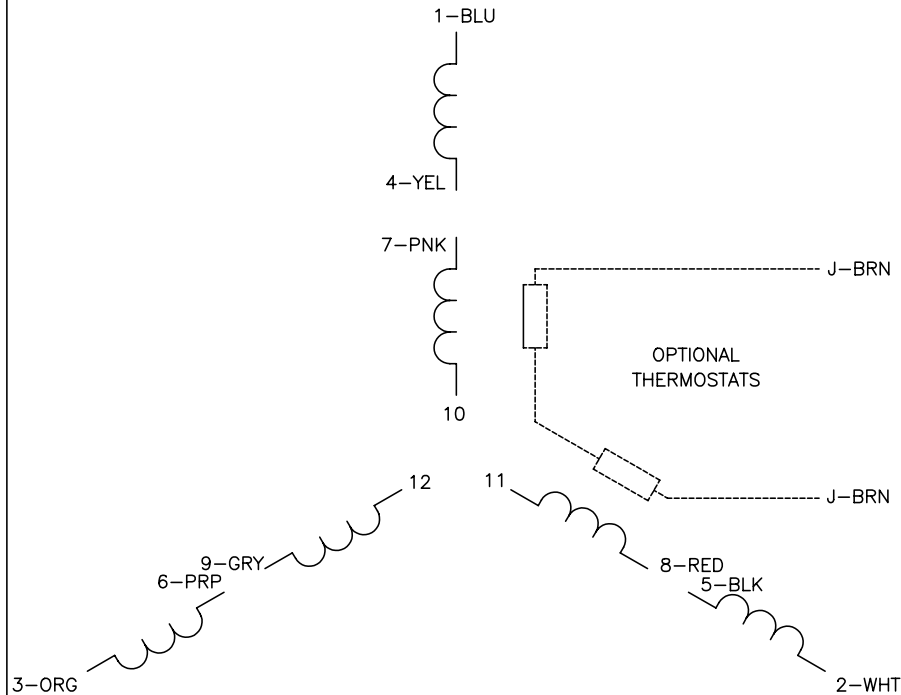

LOW VOLTAGE

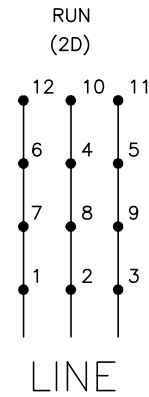
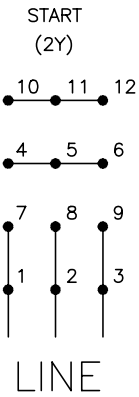

HIGH VOLTAGE

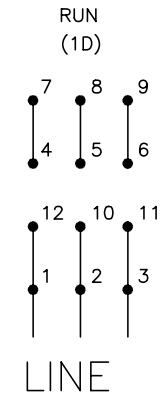
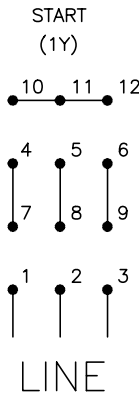

NOTES:

1. INTERCHANGE ANY TWO LINE LEADS TO REVERSE ROTATION.
2. OPTIONAL THERMOSTATS ARE PROVIDED WHEN SPECIFIED.
3. ACTUAL NUMBER OF INTERNAL PARALLEL CIRCUITS MAY BE A MULTIPLE OF THOSE SHOWN ABOVE.
4. LEAD COLORS ARE OPTIONAL. LEADS MUST ALWAYS BE NUMBERED AS SHOWN.

REV. DESC: REVISE TO SHOW OPTIONAL COLORS			
REV. LTR: C	BY: JLP	REVISED: 01/19/99 4:24	TDR: 0171435
CD0104		FILE: AAA00008377	MDL: -
		MTL: -	

BALDOR ELECTRIC Co.

3PH, DV, 12 LEADS, Y START/D RUN

CD0104

Marketing maintained PDF of MN416:

<http://www.baldor.com/support/Literature/Load.ashx/MN416?ManNumber=MN416>