





Air Operated Double Diaphragm Pump



To Purchase:

-  800-990-7867
-  sales@yamadapump.com
-  Find My Rep

More Information:

-  YouTube: @yamadapump
-  yamadapump.com
- Data Sheets | CAD Drawings | Manuals Literature | BOM | Performance Curves*

Trial Program

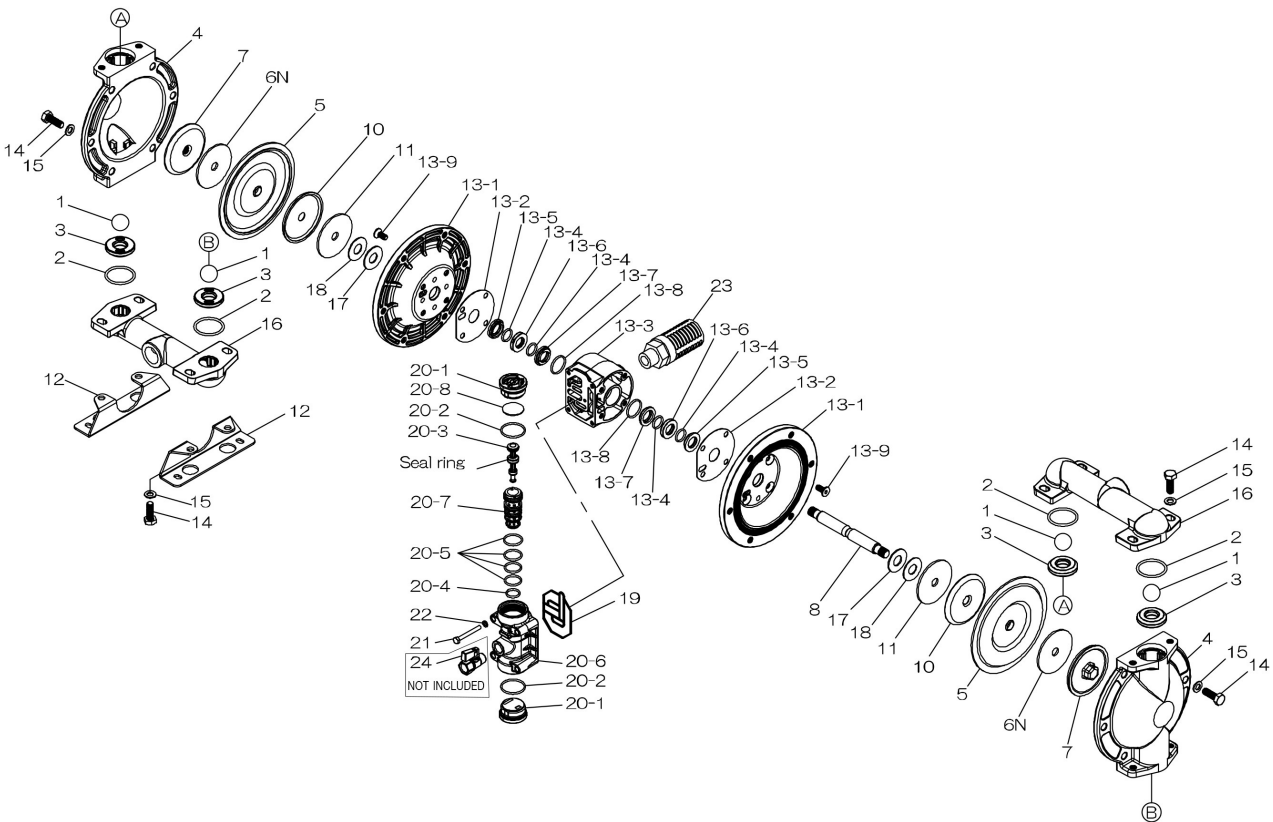

Air Operated Double Diaphragm Pump

REF. No.	PART No.	PART No.	PART No.	DESCRIPTION	QTY.	REORDER
	G25AH	G25AN	G25AS			
	854999	854995	855001			
1	773126	770720	773170	BALL	4	
2	640041	640041	686818	O-RING	4	
3	581130	581130	581130	VALVE SEAT	4	
4	716959	716959	716959	OUT CHAMBER	2	
5	771363	772962	771974	DIAPHRAGM 25	2	
6N	-	773442	-	SPACER	2	
7	716958	716958	716958	CENTER DISK (LIQUID SIDE)	2	
8	717224	717224	717224	CENTER ROD	1	
10	716258	716258	716258	CENTER DISK (AIR SIDE)	2	
11	716259	716259	716259	WASHER	2	
12	717031	717031	717031	BASE	2	
13	805262	805262	805262	BODY ASSY.	1	
13-1	717223	717223	717223	AIR CHAMBER	2	
13-2	773441	773441	773441	GASKET	2	
13-3	717219	717219	717219	BODY	1	
13-4	640016	640016	640016	O-RING	4	
13-5	773452	773452	773452	GUIDE BUSH C	2	
13-6	773451	773451	773451	GUIDE BUSH B	2	
13-7	773450	773450	773450	GUIDE BUSH A	2	
13-8	683112	683112	683112	O-RING	2	
13-9	682486	682486	682486	BOLT FLAT HD W/WASHER	8	
14	611175	611175	611175	BOLT	20	
15	631917	631917	631917	WAVE WASHER	20	
16	717218	717218	717218	MANIFOLD NPT	2	
17	771054	771054	771054	CUSHION	2	
18	773443	773443	773443	CUSHION	2	
19	773440	773440	773440	GASKET	1	
20	805265	805265	805265	VALVE BODY ASSY.	1	
20-1	716917	716917	716917	CAP A	2	
20-2	686734	686734	686734	O-RING	2	
20-3	805208	805208	805208	SPOOL ASSY.	1	
20-4	685453	685453	685453	O-RING	1	
20-5	685276	685276	685276	O-RING	4	
20-6	717222	717222	717222	VALVE BODY	1	
20-7	773444	773444	773444	SLEEVE	1	
20-8	773280	773280	773280	CUSHION	1	
21	611111	611111	611111	BOLT	4	
22	631915	631915	631915	WAVE WASHER	4	
23	804697	804697	804697	MUFFLER	1	
KIT	KG25-AH	KG25-AN	KG25-AS	LIQUID END KIT		
KIT	KG25-AM-M			AIR MOTOR KIT		

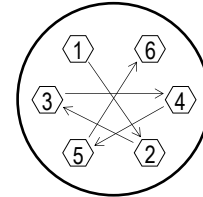

Tightening torque for center rod and out chambers.

Center Rod	354 in-lbf {40 N-m}
Out Chambers G25AN	89 in-lbf {10 N-m}
Out Chambers G25AH/S	177 in-lbf {20 N-m}

Tightening torque for manifold retainer bolts or nuts.

G25AN/H/S	89 in-lbf {10 N-m}
-----------	--------------------

General Tools:

- Socket wrench - 10mm, 17mm
- Hexagonal box wrenches - 5mm
- Open-end wrenches - 10mm, 13mm, 17mm

Special Tools (sold separately):

- Cap & disc remover (771132).
- Sleeve remover (713148).

Miscellaneous:

- Assembly Oil - turbine oil none additional class 1 (equivalent to ISO VG32 grade)
- Nuts - M14 x 1.5 class 3
- Urea grease grade (NLGI) No. 2

Customer Notes

Model #: _____
 Description: _____
 Serial #: _____
 Date Installed: _____
 Department Location: _____
 Tag/Project: _____

Order Online: www.PumpCatalog.com