

# EOM

ENGINEERING OPERATION  
& MAINTENANCE

# A100 Accu-Flo Bolted Plastic Pump

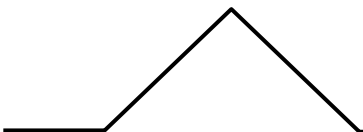

Where Innovation Flows

**WILDEN®**

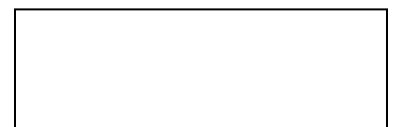

## Contents

<b>Section 1: Precautions - Read First!</b> .....	<b>4</b>
<b>Section 2: Wilden Pump Designation System</b> .....	<b>5</b>
<b>Section 3: Dimensional Drawings</b> .....	<b>6</b>
A100 Plastic.....	6
A100B Plastic.....	6
<b>Section 4: Performance</b> .....	<b>7</b>
A100 Plastic Rubber-Fitted.....	7
A100 Plastic PTFE-Fitted.....	7
Suction-Lift Curves.....	8
<b>Section 5: Exploded View and Parts List</b> .....	<b>9</b>
A100 Plastic.....	9
<b>Section 6: Elastomer Options/Electrical Information</b> .....	<b>11</b>

**Copyright**

Copyright 2018 PSG®, a Dover Company. All rights reserved.

PSG reserves the right to modify the information and illustrations in this document without prior notice. The product described in this document is furnished under a license agreement or nondisclosure agreement. No part of this document may be reproduced, stored in a retrieval system, or transmitted in any form or any means electronic or mechanical, including photocopying and recording, without the written permission of PSG, a Dover Company, except as described by the terms of those agreements.

This is a non-contractual document. 01-2019.

**Trademarks**

PSG and the PSG logo are registered trademarks of PSG. Wilden® is a registered trademark of PSG California LLC. Pro-Flo® SHIFT and Pro-Flo® are registered trademarks of PSG California LLC. Wil-Flex® is a trademark of PSG California LLC. Saniflex™ is a trademark of PSG California LLC.

All trademarks, names, logos and service marks (collectively "trademarks") in this document are registered and unregistered trademarks of their respective owners. Nothing contained in this document should be construed as granting any license or right to use any trademark without the prior written permission of the trademark owner.

**Warranty**

Each and every product manufactured by Wilden is built to meet the highest standards of quality. Every pump is functionally tested to insure integrity of operation. Wilden warrants that pumps, accessories and parts manufactured or supplied by it to be free from defects in material and workmanship for a period of five (5) years from date of installation or six (6) years from date of manufacture, whichever comes first.

For more information, and to register your Wilden pump for warranty, please visit <https://www.psgdover.com/wilden/support/warranty-registration>.

**Certifications**

**Section 1**

**Precautions - Read First!**

 **TEMPERATURE LIMITS:**

Acetal	-29°C to 82°C	-20°F to 180°F
Buna-N	-12°C to 82°C	10°F to 180°F
Geolast®	-40°C to 82°C	-40°F to 180°F
Neoprene	-18°C to 93°C	0°F to 200°F
Nordei® EPDM	-51°C to 138°C	-60°F to 280°F
Nylon	-18°C to 93°C	0°F to 200°F
PFA	-7°C to 107°C	45°F to 225°F
Polypropylene	0°C to 79°C	32°F to 175°F
Polyurethane	-12°C to 66°C	10°F to 150°F
PVDF	-12°C to 107°C	10°F to 225°F
Saniflex™	-29°C to 104°C	-20°F to 220°F
SIPD PTFE with EPDM-backed	4°C to 137°C	40°F to 280°F
SIPD PTFE with Neoprene-backed	4°C to 93°C	40°F to 200°F
PTFE <sup>1</sup>	4°C to 104°C	40°F to 220°F
FKM	-40°C to 177°C	-40°F to 350°F
Wil-Flex™	-40°C to 107°C	-40°F to 225°F

<sup>1</sup>4°C to 149°C (40°F to 300°F) - 13 mm (1/2") and 25 mm (1") models only.

**NOTE:** Not all materials are available for all models. Refer to Section 2 for material options for your pump.

 **CAUTION:** When choosing pump materials, be sure to check the temperature limits for all wetted components. Example: FKM has a maximum limit of 177°C (350°F) but polypropylene has a maximum limit of only 79°C (175°F).

 **CAUTION:** Maximum temperature limits are based upon mechanical stress only. Certain chemicals will significantly reduce maximum safe operating temperatures. Consult engineering guide for chemical compatibility and temperature limits.

 **CAUTION:** Always wear safety glasses when operating pump. If diaphragm rupture occurs, material being pumped may be forced out air exhaust.

 **WARNING:** Prevent static sparking. If static sparking occurs, fire or explosion could result. Proper grounding of pump, valves, and containers is critical when handling flammable fluids and whenever discharge of static electricity is a hazard.

 **CAUTION:** Do not exceed 8.6 bar (125 psig) air supply pressure.

 **CAUTION:** Plastic pumps are made with plastic that is not UV-stabilized. Direct sunlight for prolonged periods can cause deterioration of plastics.

 **CAUTION:** Before any maintenance or repair is attempted, the compressed air line to the pump should be disconnected and all air pressure allowed to bleed from pump. Disconnect all intake, discharge and air lines. Drain the pump by turning it upside down and allowing any fluid to flow into a suitable container.

 **CAUTION:** Blow out air line for 10 to 20 seconds before attaching to pump to make sure all pipe line debris is clear. Use an in-line air filter. A 5µ (micron) air filter is recommended

 **NOTE:** Tighten all bolts prior to installation. Fasteners may loosen during transportation.

 **NOTE:** When installing PTFE diaphragms, it is important to tighten outer pistons simultaneously (turning in opposite directions) to ensure tight fit.

 **CAUTION:** Verify the chemical compatibility of the process and cleaning fluid to the pump's component materials in the Chemical Resistance Guide.

 **CAUTION:** When removing the end cap using compressed air, the air valve end cap may come out with considerable force. Hand protection such as a padded glove or rag should be used to capture the end cap.

 **CAUTION:** Do not over-tighten the air inlet reducer bushing. Additionally, too much torque on the muffler may damage the air valve muffler plate.

 **CAUTION:** The A100 plastic pump is not submersible.

 **CAUTION:** Only explosion proof (NEMA 7) solenoid valve should be used in areas where explosion proof equipment is required.

**Section 2**

**WILDEN PUMP DESIGNATION SYSTEM**

**A100 PLASTIC**

**13 mm (1/2") Pump**  
**Maximum Flow Rate:**  
**42.4 lpm (11.2 gpm)**

**LEGEND**

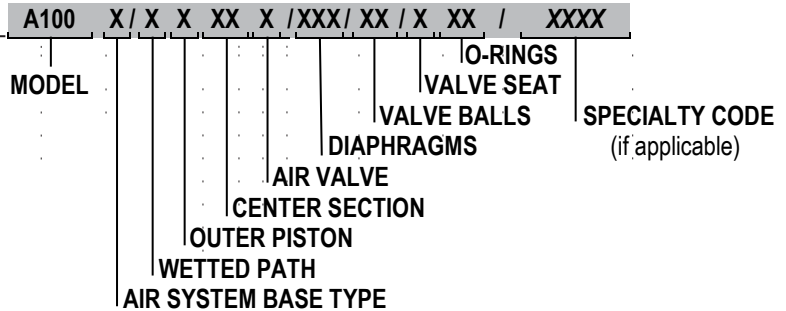

**MATERIAL CODES**

**MODEL**

A100 = PLASTIC

**AIR SYSTEM BASE TYPE**

P = PRO-FLO®

B = ADAPTER BLOCK

**WETTED PATH**

K = PVDF

P = POLYPROPYLENE

**OUTER PISTON**

K = PVDF

P = POLYPROPYLENE

**CENTER SECTION**

PP = POLYPROPYLENE

**AIR VALVE**

P = POLYPROPYLENE

**DIAPHRAGMS**

BNS = BUNA-N (Red Dot)

FSS = SANIFLEX™

[Hytrel® (Cream)]

PUS = POLYURETHANE

(Clear)

THU = PTFE W/HIGH-TEMP

BUNA-N BACKUP

(White)

TNL = PTFE W/NEOPRENE

BACKUP O-RING, IPD

(White)

TNU = PTFE W/NEOPRENE

BACKUP (White)

VTS = FKM (White Dot)

WFS = WIL-FLEX™

[Santoprene®

(Three Black Dots)]

**VALVE BALLS**

BN = BUNA-N (Red Dot)

FS = SANIFLEX™

[Hytrel® (Cream)]

PU = POLYURETHANE

(Brown)

TF = PTFE (White)

VT = FKM (White Dot)

WF = WIL-FLEX™

[Santoprene®

(Three Black Dots)]

**VALVE SEATS**

K = PVDF

P = POLYPROPYLENE

**VALVE SEAT O-RINGS**

BN = BUNA-N

FS = SANIFLEX™

[Hytrel® (Cream)]

PU = POLYURETHANE

(Brown)

TV = PTFE ENCAP. FKM

WF = WIL-FLEX™

(Santoprene®)

**SPECIALTY CODES**

0150 Accu-Flo™, 24V DC coil

0151 Accu-Flo™, 24V AC / 12V DC coil 0155 Accu-Flo™, 110V AC coil

0160 Accu-Flo™, 24V DC coil, BSPT

0512 Adapter block, no muffler, Pro-Flo®, center section

0682 P100 with OEM manifold, Accu-Flo™ 24V DC Coil

**NOTE:** Most elastomeric materials use colored dots for identification.

**NOTE:** Not all models are available with all material options.

Santoprene® is a registered trademark of Monsanto Company, licensed to Advanced Elastomer Systems, L.P.

Hytrel® is a registered trademark of DuPont Dow Elastomers.

**Section 3**

**DIMENSIONAL DRAWING**

**A100 Plastic**

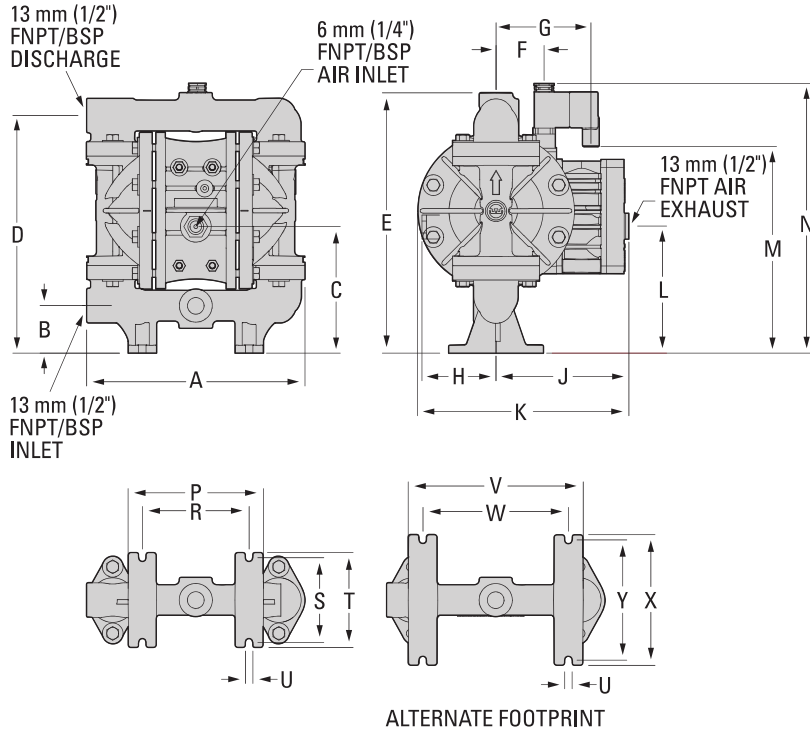

**DIMENSIONS**

ITEM	METRIC (mm)	STANDARD (inch)
A	234	9.2
B	51	2.0
C	135	5.3
D	254	10.0
E	279	11.0
F	51	2.0
G	102	4.0
H	79	3.1
J	142	5.6
K	226	8.9
L	137	5.4
M	224	8.8
N	277	10.9
P	145	5.7
R	114	4.5
S	91	3.6
T	102	4.0
U	8	0.3
V	188	7.4
W	155	6.1
X	140	5.5
Y	130	5.1

**A100B Plastic**

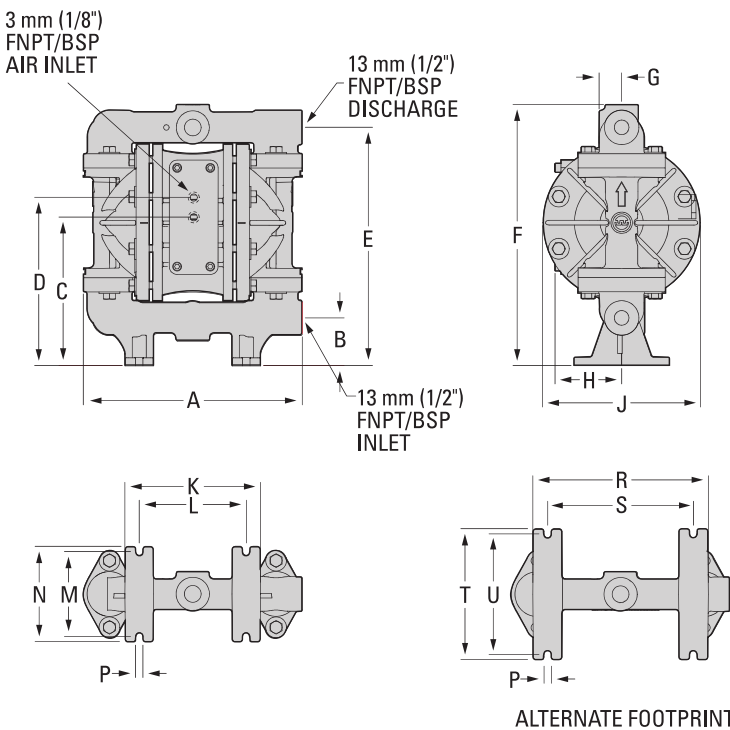

**DIMENSIONS**

ITEM	METRIC (mm)	STANDARD (inch)
A	234	9.2
B	51	2.0
C	157	6.2
D	180	7.1
E	254	10.0
F	279	11.0
G	25	1.0
H	66	2.6
J	168	6.6
K	145	5.7
L	114	4.5
M	91	3.6
N	102	4.0
P	8	0.3
R	188	7.4
S	155	6.1
T	140	5.5
U	130	5.1

**Section 4**

**PERFORMANCE**

**A100 PLASTIC RUBBER-FITTED**

Est. Ship Weight.. Polypropylene 4 kg (8 lb)  
PVDF 5 kg (10 lb)  
Air Inlet..... 6 mm (1/4")  
Inlet..... 13 mm (1/2")  
Outlet..... 13 mm (1/2")  
Suction Lift ..... Dry 6.6 m (21.5')  
Wet 9.0 m (29.5')  
Disp. Per Stroke<sup>1</sup> ..... 0.11 L (0.03 gal)  
Max. Flow Rate..... 42.4 lpm (11.2 gal)  
Max. Size Solids..... 1.6 mm (1/16")

<sup>1</sup>Displacement per stroke was calculated at 4.8 bar (70 psig) air inlet pressure against a 2.0 bar (30 psig) head pressure.

**Example:** To pump 17.4 lpm (4.6 gpm) against a discharge head pressure of 1.4 bar (20 psig) requires 2.8 bar (40 psig) and 13.6 Nm<sup>3</sup>/h (8 scfm) air consumption. (See dot on chart.)

**Caution:** Do not exceed 8.6 bar (125 psig) air supply pressure.

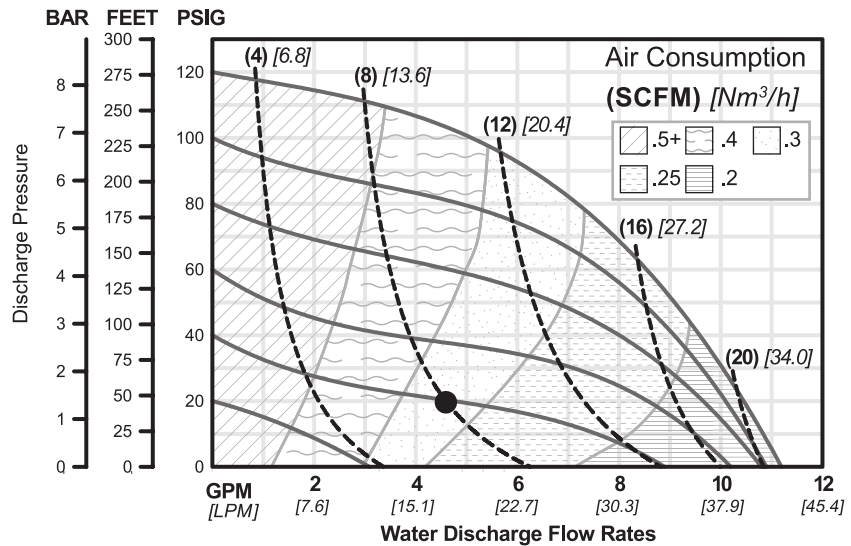

Flow rates indicated on chart were determined by pumping water.

For optimum life and performance, pumps should be specified so that daily operation parameters will fall in the center of the pump's performance curve.

**A100 PLASTIC PTFE-FITTED**

Est. Ship Weight.. Polypropylene 4 kg (8 lb)  
PVDF 5 kg (10 lb)  
Air Inlet..... 6 mm (1/4")  
Inlet..... 13 mm (1/2")  
Outlet..... 13 mm (1/2")  
Suction Lift ..... Dry 5.7 m (18.7')  
Wet 9.3 m (30.6')  
Disp. Per Stroke<sup>1</sup> ..... 0.11 L (0.03 gal)  
Max. Flow Rate..... 38.2 lpm (10.1 gal)  
Max. Size Solids..... 1.6 mm (1/16")

<sup>1</sup>Displacement per stroke was calculated at 4.8 bar (70 psig) air inlet pressure against a 2.0 bar (30 psig) head pressure.

**Example:** To pump 11.4 lpm (3.0 gpm) against a discharge head pressure of 2.1bar (30 psig) requires 2.8 bar (40 psig) and 6.8 Nm<sup>3</sup>/h (4 scfm) air consumption. (See dot on chart.)

**Caution:** Do not exceed 8.6 bar (125 psig) air supply pressure.

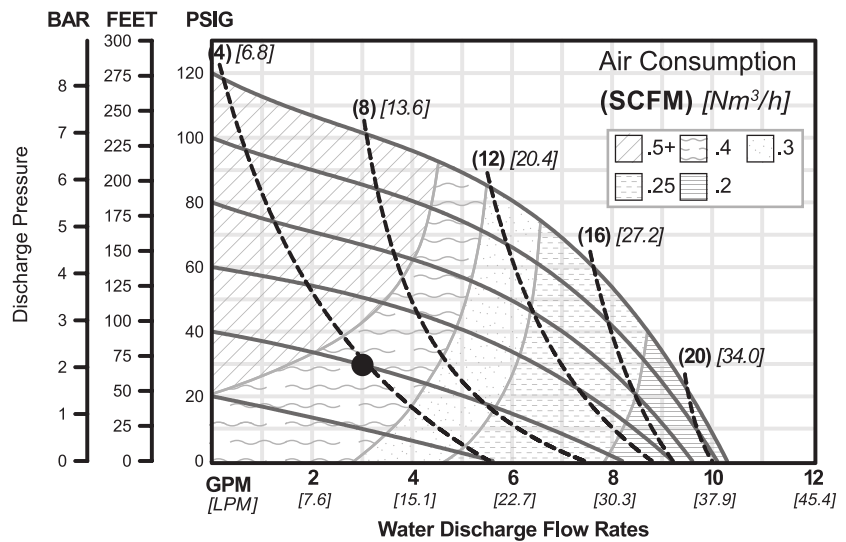

Flow rates indicated on chart were determined by pumping water.

For optimum life and performance, pumps should be specified so that daily operation parameters will fall in the center of the pump's performance curve.

## SUCTION LIFT CURVES

### A100 PLASTIC

These curves demonstrate the flow created when the stroke rate is modified under static air and fluid pressure condition. This curve can be applied to different pressure conditions to estimate the change in flow due to stroke rate

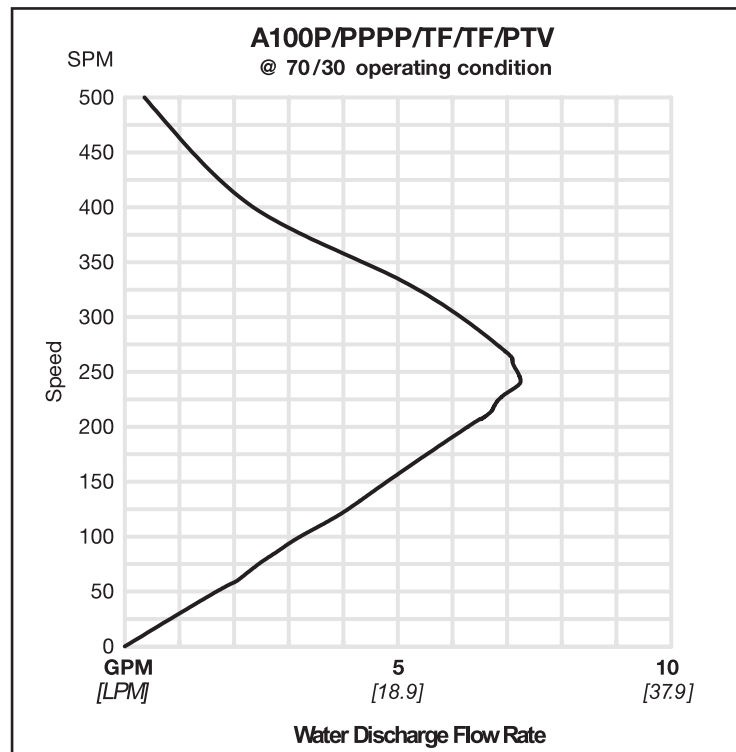
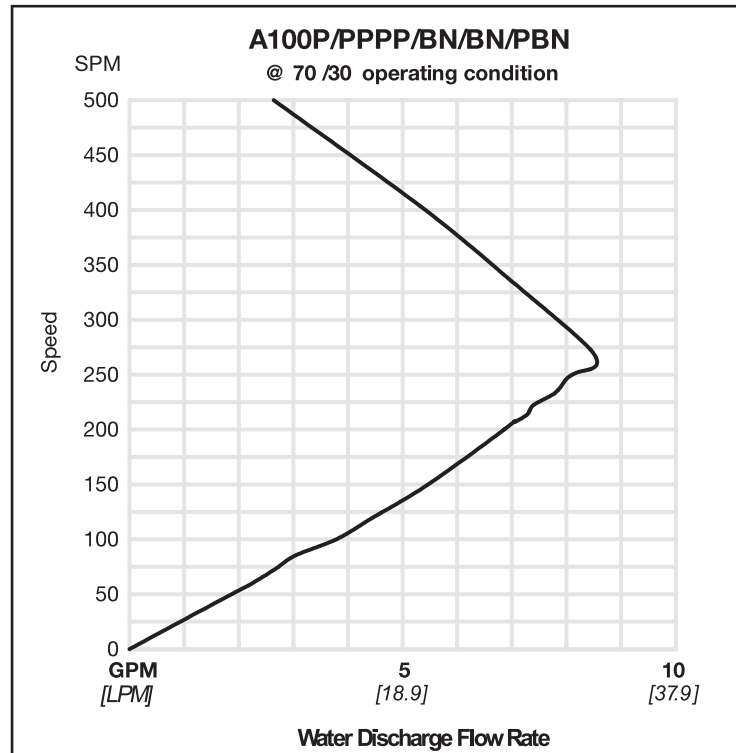

**Section 5**

**EXPLODED VIEW AND PARTS LISTING**

**A100 PLASTIC**

PTFE - Fitted

EXPLODED VIEW

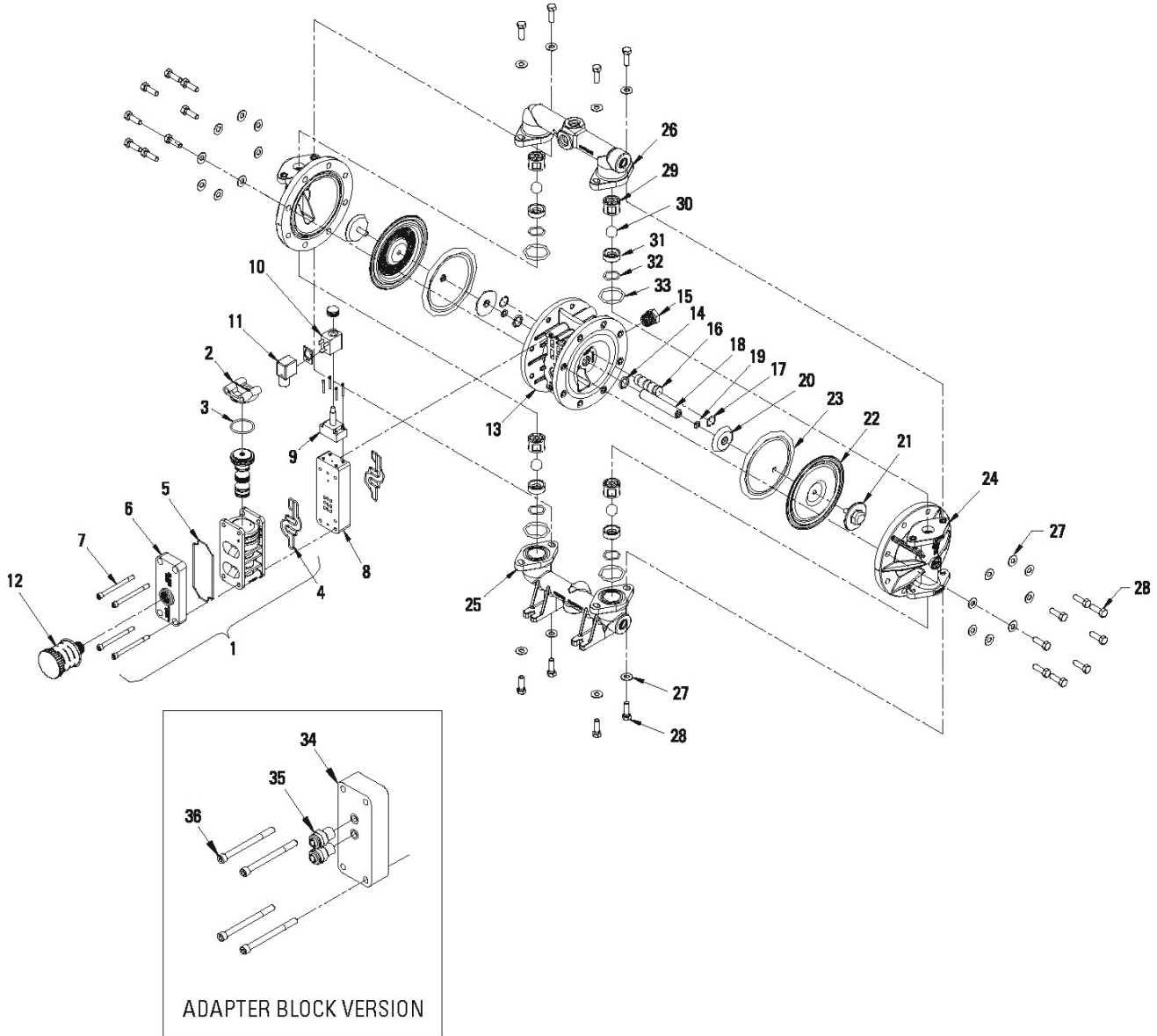

## Exploded View and Parts List

Item	Description	Qty.	A100P/PKPPP/0151 P/N	A100P/KKPPP/0151 P/N
1	Air Valve Assembly <sup>1</sup>	1	01-2010-20	01-2010-20
2	End Cap	1	01-2332-20	01-2332-20
3	O-ring, (.103 x 1.362)	1	01-2395-52	01-2395-52
4	Gasket, Air Valve	2	01-2615-52	01-2615-52
5	Gasket, Muffler Plate	1	01-3505-52	01-3505-52
6	Muffler Plate	1	01-3181-20	01-3181-20
7	Air Valve Screws, SHC, 1/4-20 x 4.5	4	01-6000-03	01-6000-03
8	Solenoid Spacer Plate	1	01-2160-20	01-2160-20
9	Operator, Solenoid, Nema 4	1	00-2120-99	00-2120-99
10	Coil	1	00-2110-99-151	00-2110-99-151
11	Terminal Connector	1	00-2130-99	00-2130-99
12	Muffler, 1/2"	1	02-3510-99	02-3510-99
13	Center Section	1	01-3141-20	01-3141-20
14	<b>Glyd-Ring II, (.618 x .136)</b>	<b>2</b>	<b>01-3220-55</b>	<b>01-3220-55</b>
15	Reducer Bushing	1	01-6950-20	01-6950-20
16	Pilot Plug Assy	1	01-2285-99	01-2285-99
17	Retaining Ring	2	00-2650-03	00-2650-03
18	Shaft	1	01-3810-03	01-3810-03
19	Disc Spring (.331 x .512)	2	01-6802-08	01-6802-08
20	Piston, Inner, (Combo)	2	01-3711-08	01-3711-08
21	Piston, Outer, (Combo)	2	01-4570-21-500	01-4570-21-500
22	<b>Diaphragm, Primary, PTFE</b>	<b>2</b>	<b>01-1010-55</b>	<b>01-1010-55</b>
23	<b>Diaphragm, Back-Up, Neoprene</b>	<b>2</b>	<b>01-1060-51</b>	<b>01-1060-51</b>
24	Liquid Chamber	2	01-5005-20	01-5005-21
25	Inlet Manifold	1	01-5095-20	01-5095-21
26	Discharge Manifold	1	01-5035-20	01-5035-21
27	Washer (.343 x .750 x .05)	24	01-6732-03	01-6732-03
28	Screw, HHC, 5/16-18 x 1.13	24	01-6191-03	01-6191-03
29	Ball Cage	4	01-5355-20	01-5355-21
30	<b>Valve Ball</b>	<b>4</b>	<b>01-1080-55</b>	<b>01-1080-55</b>
31	<b>Valve Seat</b>	<b>4</b>	<b>01-1125-20</b>	<b>01-1125-21</b>
32	<b>Valve Seat O-ring (.924 x .103)</b>	<b>4</b>	<b>01-1205-60</b>	<b>01-1205-60</b>
33	<b>Manifold O-ring (1.484 x .139)</b>	<b>4</b>	<b>05-1370-60</b>	<b>05-1370-60</b>
34	Adapter Block	1	01-2155-20	01-2155-20
35	Adapter Block Air Fittings	2	00-2170-20	00-2170-20
36	Air Valve Screws, SHC, 1/4-20 x 2	4	04-6000-03	04-6000-03
	Alternate OEM Manifold (not shown)	1	01-5097-20	01-5097-21
	Drum Pump Manifold (not shown)	1	01-5094-20	01-5094-21
	Pipe Plug (not shown)	1	01-7101-20	01-7101-21

<sup>1</sup>Air Valve Assembly includes items 2 & 3  
**All Boldface items are primary wear parts.**

**Section 6**

**Elastomer Options**

**A100P & A100B PLASTIC**

Material	Diaphragms	Valve Balls	Valve Seats	Valve Seat O-Rings	Manifold O-Rings
Polyurethane	01-1010-50	01-1080-50		01-1200-50	02-1230-50
Buna-N	01-1010-52	01-1080-52		00-1260-52	02-1230-52
FKM	01-1010-53	01-1080-53			
Wil-Flex™	01-1010-58	01-1080-58		00-1260-58	01-1370-58
Saniflex™	01-1010-56	01-1080-56		01-1200-56	01-1370-56
PTFE	01-1010-55	01-1080-55			
PTFE with Integral Piston	01-1030-55				
Encapsulated/FKM				01-1205-60	05-1370-60
PVDF			01-1125-21		
Polypropylene			01-1125-20		

**Coil Options**

Specialty Code	Part Number	Description
150	00-2110-99-150	24V DC
154	00-2110-99-154	24V DC, NEMA 7
157	00-2110-99-157	24V DC, International
151	00-2110-99-151	24V AC/12V DC
153	00-2110-99-153	24V AC/12V DC, NEMA 7
155	00-2110-99-155	110V AC
156	00-2110-99-156	110V AC, NEMA 7

**Adapter Block Options**

Part Number	Description
01-2155-13	Acetal
01-2155-20	Polypropylene

**Operator Options**

Part Number	Description
00-2120-99	Nema 4
00-2121-99	Nema 7

PSG  
22069 Van Buren Street  
Grand Terrace, CA 92313-5651 USA  
P: +1 (909) 422-1730 • F: +1 (909) 783-3440  
psgdover.com



Where Innovation Flows

PSG® reserves the right to modify the information and illustrations contained in this document without prior notice. This is a non-contractual document. 05-2018